



HEP



HEPT



HPX

AXIAL FANS

ROOF FANS



HT



CVT



CHT

AXIAL FANS
AND ROOF FANS

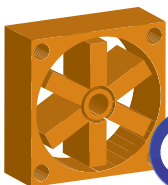

According
EU Regulation





OUR COMMITMENT TO THE ENVIRONMENT

Sodeca has begun a new stage of study and design of new trends in ventilation which will help to preserve the environment and to make the energy saving which so much concerns today's society.



EFFICIENT WORK

SODECA is pleased to present its new efficient, high performance "Efficient Work" fans, equipped with high-tech motors for greater energy savings. These new products exceed the requirements of the Ecodesign ErP Directive of 2009/125/CE and the (EU) regulation 327/2011 governing fans and adhere to the KYOTO goals adopted by the EU for cutting greenhouse gas emissions.

SODECA has concentrated its activity on the production of industrial fans, ventilation systems and extractors for the removal of smoke in case of fire since 1983, when it was founded.

SODECA's fans and extractors are present in all European countries and in many parts of the world, thanks to the quality of the product and the methods of research and development used.

Our quality procedures, used and certified by BUREAU VERITAS, in accordance with ISO 9001:2008, are another of the reasons which make **SODECA** one of the best and most renowned fan manufacturers in Europe.

Without a doubt, the most important factor for achieving our objectives is the human factor, the great professionals who work at your service, offering not only ventilation equipment but also solutions to any ventilation need required by our customers.

We offer you the possibility of visiting our facilities in Sant Quirze de Besora, with over 16,000² square metres of built area, where you will be able to see our fans being manufactured to the highest standards of quality, complying with the ISO and AMCA standards.

This catalogue only represents a small part of our product and services offering. Do not hesitate to contact us. We will put all our experience and our human resources at your disposal.



SODECA S.L.U. main facilities in E-08580 SANT QUIRZE DE BESORA



AXIAL AND ROOF FANS

Sodeca has specialised since its inception in the design and manufacture of fans and accessories for industrial applications.

The combination of our experience acquired over decades of working with fans and the technological contribution of our engineers in different departments has made it possible for Sodeca to become one of the largest manufacturers of industrial ventilation in the world.

Industrial applications demand the ability to adapt to the specifications of each project as well as manufacturing flexibility so as to satisfy the real needs of each client.

In order to meet this objective, Sodeca produces a range of Standard products and a range of specially manufactured products in order to build fans that adapt to the demands of our clients.

For many years we have been making a continuous investment in the development of internal processes and applications in order to manufacture and supply special industrial fans within a very short design and production period.

Teamwork in our engineering department, our work with universities and technological centres, as well as the close collaboration between the design departments of our external partners makes it possible to achieve innovative solutions in industrial ventilation in a short period of time.

Throughout our history, we have developed all kinds of technology in fans for industrial applications which are currently used all over the world. It is our objective to continue to invest in this sector so as to continue to be one of the most esteemed manufacturers of industrial fans in the world.



AXIAL FANS

<p>HEP</p>  <p>Wall-mounted axial fans, with IP-65 motor</p> <p>8</p>	<p>HEPT</p>  <p>Long-cased axial fans, with IP-65 motor</p> <p>8</p>	<p>HC</p>  <p>Wall-mounted axial fans with IP-55 motor</p> <p>13</p>	<p>HCD</p>  <p>Small-diameter wall-mounted axial fans</p> <p>19</p>
<p>HCRE</p>  <p>Low noise wall-mounted axial fans with sheet steel impeller and external rotor motors</p> <p>21</p>	<p>HRE</p>  <p>Circular axial fans with external rotor motor</p> <p>21</p>	<p>HCH HCT</p>  <p>Robust wall-mounted axial and long-cased fans</p> <p>25</p>	<p>HFW</p>  <p>Hot galvanised cased fans</p> <p>HEAVY DUTY</p> <p>36</p>
<p>CJHCH</p>  <p>Axial ventilation units with soundproofed box</p> <p>41</p>	<p>HTP</p>  <p>HEAVY DUTY</p> <p>Cased high-pressure axial fans</p> <p>44</p>	<p>HGT</p>  <p>HEAVY DUTY</p> <p>Large diameter long cased axial fans with direct drive motor</p> <p>60</p>	<p>HGTX</p>  <p>HEAVY DUTY</p> <p>Large diameter long cased axial fans with external motor</p> <p>60</p>
<p>HTM</p>  <p>Axial fans mobile long cased</p> <p>97</p>	<p>HPX</p>  <p>Long cased axial fans with external motor</p> <p>99</p>	<p>HBA</p>  <p>HEAVY DUTY</p> <p>Axial fans Forked tubular fans</p> <p>102</p>	<p>HPX/SEC</p>  <p>HEAVY DUTY</p> <p>Fans for extreme conditions in ovens and driers</p> <p>104</p>
<p>HCH/SEC</p>  <p>Fans specially designed for operation in ceramic and wooden driers</p> <p>106</p>	<p>VAM VAC</p>  <p>Axial fans with galvanised frame and IP-65 motor and for ducts with IP-65 motor</p> <p>108</p>	<p>HGI</p>  <p>Large-diameter axial fans</p> <p>110</p>	<p>KITS DE SOBREPRESIÓN</p>  <p>111</p>

ROOF FANS

HTMH



Multifunctional roof fans for large flows

115

HT



Axial roof fans with flat base

123

HTTI



Axial roof fans with sloping base depending on the roof slope

127

CHT

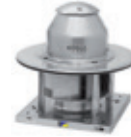

400°C/2h centrifugal roof fans with horizontal outlet air, hood in aluminium

130

CVT



400°C/2h centrifugal roof fans with vertical air outlet, hood in aluminium

130

RFHD



Centrifugal roof fans with horizontal air outlet and ATEX Ex d certification

135

CHRE



Centrifugal roof fans with low noise level

139

CTD



Centrifugal roof fans for extraction from house chimneys

142

CA-ROOF



Centrifugal roof fans for extraction from house chimneys

144

TIRACAMINO



Fans to extract smoke from chimneys and barbecues

146

RCH RCH-400X800 VM



Fan and chimney top for hybrid extraction in community housing

147

AXIAL AND
ROOF FANS

CENTRIFUGAL AND IN-LINE
EXTRACTORS

FANS FOR
SMOKE
EXTRACTION

ATEX FANS FOR
EXPLOSIVE ATMOSPHERES
AND OTHER APPLICATIONS



NEW SERIES - NEW PRODUCTS

NEW CATALOGUES



NEW BUSINESS OPPORTUNITIES

LOW-PRESSURE
CENTRIFUGAL FANS

HEAT RECOVERY
SYSTEMS AND
FILTRATION UNITS

AIR CURTAINS FOR
COMMERCIAL AND
INDUSTRIAL APPLICATIONS

VENTILATION
SYSTEMS FOR
HOUSES



**Request
information**



Crta. de Berga, km 0.7
E-08580 St. Quirze de Besora
BARCELONA (Spain)
Tel. +34 93 852 91 11
Fax.+34 93 852 90 42

comercial@sodeca.com
Export sales: ventilation@sodeca.com
www.sodeca.com



STANDARDS COMPLIANCE

SODECA's fans and extractors comply with the following standards:

QUALITY	
ISO 9001:2008	Sistemas de gestión de la calidad. Requisitos. Quality management systems -- Requirements
TESTS	
ISO 5801	Ventiladores industriales. Ensayos de comportamiento en circuitos normalizados. Industrial fans -- Performance testing using standardized airways
AMCA 210-07	Ventiladores industriales. Métodos de ensayos de ventiladores y su representación de ensayos. Laboratory Methods of Testing Fans for Aerodynamic Performance Rating
UNE-EN ISO 5801	Ventiladores. Dispositivos e instalaciones para el ensayo de ventiladores.
UNE-EN ISO 13350	Ensayos de comportamiento de ventiladores de chorro. Industrial fans -- Performance testing of jet fans
ISO 13348	Industrial fans -- Tolerances, methods of conversion and technical data presentation
FANS FOR HIGH TEMPERATURES	
EN 12101-3	Sistemas de control de humos y calor. Parte 3: Especificaciones para aireadores extractores de humos y calor mecánicos. Smoke and heat control systems - Part 3: Specification for powered smoke and heat exhaust ventilators
ACOUSTICS	
ISO 3744	Acústica. Determinación de los niveles de potencia acústica de fuentes de ruido a partir de la presión acústica. Método de ingeniería para condiciones de campo libre sobre un plano reflectante. Acoustics -- Determination of sound power levels of noise sources using sound pressure -- Engineering method in an essentially free field over a reflecting plane
BALANCE AND VIBRATIONS	
ISO 1940-1	Vibraciones mecánicas. Calidad de equilibrado Mechanical vibration -- Balance quality requirements for rotors in a constant (rigid) state -- Part 1: Specification and verification of balance tolerances
ISO 10816-1	Vibraciones mecánicas. Evaluación de las vibraciones de máquinas Mechanical vibration -- Evaluation of machine vibration by measurements on non-rotating parts -- Part 1: General guidelines
ISO 14694	Ventiladores industriales. Especificaciones para equilibrado y niveles de vibración Industrial fans -- Specifications for balance quality and vibration levels
SAFETY (Declaration of EC Compliance)	
EN ISO 12100	Seguridad de las máquinas. Conceptos básicos, principios generales para el diseño. Parte 1: Terminología básica, metodología. Safety of machinery -- Basic concepts, general principles for design -- Part 1: Basic terminology, methodology
EN ISO 12100	Seguridad de las máquinas. Conceptos básicos, principios generales para el diseño. Parte 2: Principios técnicos. Safety of machinery -- Basic concepts, general principles for design -- Part 2: Technical principles
UNE EN 60204-1	Seguridad de las máquinas. Equipo eléctrico de las máquinas. Parte 1: Requisitos generales. Safety of machinery - Electrical equipment of machines - Part 1: General requirements
ISO 13857	Seguridad de máquinas. Distancias de seguridad para impedir que se alcancen zonas peligrosas con los miembros superiores e inferiores. Safety of machinery -- Safety distances to prevent danger zones being reached by upper and lower limbs
UNE-EN ISO 12499	Ventiladores industriales. Seguridad mecánica en los ventiladores Industrial fans -- Mechanical safety of fans -- Guarding
DIRECTIVAS Y REGLAMENTOS	
Directiva 2006/42/CE	Directiva de máquinas Machinery Directive
Directiva 2006/95/CE	Directiva de baja tensión Low Voltage Directive
Directiva 2004/108/CE	Directiva compatibilidad electromagnética EMC Directive
Reglamento 305/2011	Directiva productos de construcción Construction Products Directive CPR
Directiva 2009/125/CE	Directiva de requisitos de diseño ecológico para productos que utilizan energía. Ecodesign Requirements for Energy-related Products Directive
ATEX EXECUTIONS	
Directiva ATEX 94/9/CE	Aparatos y sistemas de protección para uso en atmósferas potencialmente explosivas Equipment and protective systems intended for use in potentially explosive atmospheres
EN 14986	Diseño de ventiladores para trabajar en atmósferas potencialmente explosivas. Design of fans working in potentially explosive atmospheres
EN 13463-1	Equipos no eléctricos destinados a atmósferas potencialmente explosivas. Parte 1: Requisitos y metodología básica. Non-electrical equipment for use in potentially explosive atmospheres - Part 1: Basic method and requirements
EN 1127-1	Atmósferas explosivas. Prevención y protección contra la explosión. Parte 1: Conceptos básicos y metodología. Explosive atmospheres - Explosion prevention and protection - Part 1: Basic concepts and methodology

HEP HEPT

HEP: Wall-mounted axial fans, with IP65 motor
HEPT: Long-cased axial fans, with IP65 motor

Wall-mounted axial (HEP) and long-cased (HEPT) fans, with fibreglass-reinforced plastic impeller.



HEP



HEPT

Fan:

- Airflow direction from motor to impeller
- Impeller in polyamide 6 reinforced with fibre glass
- HEP: Sheet steel base plate.
- HEP: Protection guard to prevent contacts according to standard UNE-EN ISO 12499:2010
- HEPT: Sheet steel cased casing
- HEPT: Outside connecting box, IP-65 protection

Motor:

- Class F motors, with ball bearings, IP65 protection
- Single-phase 220-240V -50Hz. and three-phase 220-240/380-415V -50Hz.
- Fan working temperature: -25°C +60°C, 4-6-8 pole motors and -25°C +45°C, 2 pole motors

resin polymerised at 190°C, after alkaline degreasing with phosphate-free nanotechnology treatment.

On request:

- Motor, impeller and guard unit (version F)
- Motor-impeller unit (version G)
- Airflow direction from impeller to motor
- Special windings for different voltages

Finish:

- Anticorrosive finish in polyester

Order code



HEP: Wall-mounted axial fans, with IP65 motor
 HEPT: Long-cased axial fans, with IP65 motor

Impeller diameter in cm.

Number of motor poles
 4=1400 r/min. 50 Hz
 6=900 r/min. 50 Hz
 8=750 r/min. 50 Hz

T=Three-phase
 M=Single-phase
 H=High airflow
 L=Low airflow

Air circulation
 I=Impeller
 Motor->Impeller

 A=Airflow-in
 Impeller->Motor

Execution of the fan
 Execution standard

F=Motor impeller unit guard

G=Motor impeller unit

Technical characteristics

Model	Speed (r/min)	Maximum admissible current (A)		Installed power at free airflow (W)	Maximum airflow (m3/h)	Sound pressure level dB(A)	Approx. weight (Kg)	
		220-240V	380-415V				HEP	HEPT
HEP-25-2T/H	2780	1.30	0.75	265	2300	64	5.3	-
HEP-25-2M/H	2750	1.95	-	345	2300	64	5.3	-
HEP-25-4T/H	1450	0.69	0.40	85	1250	52	4.5	-
HEP-25-4M/H	1440	0.65	-	95	1250	52	4.5	-
HEP-31-2T/H	HEPT-31-2T/H	2640	1.54	0.89	400	74	7.0	7.4
HEP-31-2M/H	HEPT-31-2M/H	2640	2.30	-	410	74	7.0	7.4
HEP-31-4T/H	HEPT-31-4T/H	1410	0.69	0.40	115	55	5.7	6.2
HEP-31-4M/H	HEPT-31-4M/H	1410	0.75	-	130	55	5.7	6.2
HEP-31-4T/L	-	1430	0.69	0.40	100	54	5.1	-
HEP-31-4M/L	-	1420	0.70	-	110	54	5.1	-
HEP-35-2T/H	HEPT-35-2T/H	2790	2.16	1.25	550	76	8.8	9.4
HEP-35-2M/H	HEPT-35-2M/H	2675	2.80	-	560	76	8.8	9.4
HEP-35-4T/H	HEPT-35-4T/H	1340	0.74	0.43	155	58	7.1	7.6
HEP-35-4M/H	HEPT-35-4M/H	1340	0.98	-	160	58	7.1	7.6
HEP-35-4T/L	-	1410	0.69	0.40	110	56	6.5	-
HEP-35-4M/L	-	1410	0.75	-	120	56	6.5	-
HEP-40-4T/H	HEPT-40-4T/H	1420	2.10	1.20	245	61	10.6	13.5
HEP-40-4M/H	HEPT-40-4M/H	1400	1.85	-	355	61	10.6	13.5

Technical characteristics

Model	Speed (r/min)	Maximum admissible current (A)		Installed power at free airflow (W)	Maximum airflow (m ³ /h)	Sound pressure level dB(A)	Approx. weight (Kg)		
		220-240V	380-415V				HEP	HEPT	
HEP-40-4T/L	-	1450	2.10	1.20	185	4000	60	10.6	-
HEP-40-4M/L	-	1420	1.55	-	260	4000	60	10.6	-
HEP-40-6T/H	HEPT-40-6T/H	960	1.12	0.65	155	3500	54	10.2	13.5
HEP-40-6M/H	HEPT-40-6M/H	960	1.06	-	185	3500	54	10.2	13.5
HEP-45-4T/H	HEPT-45-4T/H	1400	2.11	1.22	475	7300	66	12.5	15.5
HEP-45-4M/H	HEPT-45-4M/H	1400	2.35	-	490	7300	66	12.5	15.5
HEP-45-4T/L	-	1440	2.10	1.20	300	5810	64	11.0	-
HEP-45-4M/L	-	1360	1.85	-	315	5810	64	11.0	-
HEP-45-6T/H	HEPT-45-6T/H	955	1.42	0.82	215	4900	56	11.4	15.5
HEP-45-6M/H	HEPT-45-6M/H	955	1.40	-	225	4900	56	11.4	15.5
HEP-50-4T/H	HEPT-50-4T/H	1420	3.10	1.80	740	10150	69	15.0	18.0
HEP-50-4M/H	HEPT-50-4M/H	1380	3.35	-	710	10150	69	15.0	18.0
HEP-50-4T/L	-	1400	2.15	1.25	390	7300	67	13.0	-
HEP-50-4M/L	-	1370	2.30	-	430	7300	67	13.0	-
HEP-50-6T/H	HEPT-50-6T/H	950	1.38	0.80	205	6150	59	13.2	18.0
HEP-50-6M/H	HEPT-50-6M/H	950	1.38	-	215	6150	59	13.2	18.0
HEP-56-4T/H	HEPT-56-4T/H	1350	3.63	2.10	870	12800	72	21.0	28.0
HEP-56-4M/H	HEPT-56-4M/H	1350	5.26	-	895	12800	72	21.0	28.0
HEP-56-4T/L	-	1400	3.20	1.85	710	10900	70	19.0	-
HEP-56-4M/L	-	1350	3.40	-	755	10900	70	19.0	-
HEP-56-6T/H	HEPT-56-6T/H	915	1.73	1.00	325	8250	62	17.0	28.0
HEP-56-6M/H	HEPT-56-6M/H	915	2.12	-	450	8250	62	17.0	28.0
HEP-63-4T/H	HEPT-63-4T/H	1415	6.92	4.00	1400	18700	82	25.8	33.5
HEP-63-4T/L	-	1375	5.01	2.90	1275	16500	75	23.0	-
HEP-63-4M/L	-	1375	5.40	-	1160	16500	75	23.0	-
HEP-63-6T/H	HEPT-63-6T/H	905	2.06	1.19	405	12050	65	20.2	33.5
HEP-63-6M/H	HEPT-63-6M/H	905	2.70	-	540	12050	65	20.2	33.5
HEP-63-6T/L	-	945	1.62	0.94	305	9450	63	19.4	-
HEP-63-6M/L	-	945	1.80	-	330	9450	63	19.4	-
HEP-63-8T/H	-	700	1.90	1.10	320	8250	57	19.2	-
HEP-63-8M/H	-	700	1.89	-	320	8250	57	19.2	-



Erp. BEP (best efficiency point) characteristics

MC	Measurement category	ηe[%]	Efficiency
EC	Efficiency category	N	Degree of efficiency
S	Static	[kW]	Electrical power
T	Total	[m³/h]	Airflow
VSD	Variable-speed drive	[mmH₂O]	Static or total pressure (According to EC)
SR	Specific relationship	[RPM]	Speed

Model	MC	EC	VSD	SR	ηe [%]	N	[kW]	[m ³ /h]	[mmH ₂ O]	[RPM]
25-4T/H	-	-	-	-	-	-	0.083	986	2.73	1471
25-4M/H	-	-	-	-	-	-	0.096	990	2.72	1466
31-2T/H	A	S	NO	1.00	30.3%	39.2	0.397	2782	15.89	2827
31-2M/H	A	S	NO	1.00	28.9%	37.6	0.417	2793	15.84	2854
31-4T/H	-	-	-	-	-	-	0.109	1304	5.05	1449
31-4M/H	-	-	-	-	-	-	0.122	1290	5.10	1461
31-4T/L	-	-	-	-	-	-	0.096	1141	4.37	1460
31-4M/L	-	-	-	-	-	-	0.109	1161	4.30	1452
35-2T/H	A	S	NO	1.00	35.3%	42.9	0.620	4356	18.46	2880
35-2M/H	A	S	NO	1.00	34.6%	42.2	0.632	4396	18.28	2851
35-4T/H	A	S	NO	1.00	28.3%	39.9	0.145	2167	6.95	1418
35-4M/H	A	S	NO	1.00	26.1%	37.4	0.158	2191	6.89	1430
35-4T/L	-	-	-	-	-	-	0.117	1874	4.95	1443
35-4M/L	-	-	-	-	-	-	0.124	1919	4.97	1451
40-4T/H	A	S	NO	1.00	26.8%	37.5	0.202	2135	9.28	1470
40-4T/L	A	S	NO	1.00	26.3%	37.5	0.172	2248	7.41	1476
45-4T/H	A	S	NO	1.00	33.1%	41.8	0.418	4235	11.98	1447
45-4M/H	A	S	NO	1.00	29.3%	37.6	0.480	4541	11.37	1450
45-4T/L	A	S	NO	1.00	33.0%	42.7	0.292	3719	9.53	1467
45-4M/L	A	S	NO	1.00	30.9%	40.4	0.314	3805	9.36	1439
50-4T/H	A	S	NO	1.00	31.1%	38.7	0.626	5994	11.92	1458



Erp. BEP (best efficiency point) characteristics

Model	MC	EC	VSD	SR	ηe [%]	N	[kW]	[m3/h]	[mmH ₂ O]	[RPM]
50-4M/H	A	S	NO	1.00	30.1%	37.6	0.645	5967	11.96	1446
50-4T/L	A	S	NO	1.00	32.9%	41.8	0.387	4894	9.54	1446
50-4M/L	A	S	NO	1.00	29.0%	37.6	0.438	4853	9.61	1434
50-6T/H	A	S	NO	1.00	28.6%	39.5	0.187	3484	5.64	977
50-6M/H	A	S	NO	1.00	26.8%	37.5	0.201	3601	5.50	979
56-4T/H	A	S	NO	1.00	31.3%	38.3	0.798	7546	12.16	1432
56-4M/H	A	S	NO	1.00	30.8%	37.7	0.817	7780	11.88	1442
56-4T/L	A	S	NO	1.00	30.3%	37.7	0.697	7344	10.57	1448
56-4M/L	A	S	NO	1.00	29.0%	36.2	0.730	7358	10.55	1432
56-6T/H	A	S	NO	1.00	27.7%	37.5	0.283	4469	6.46	964
63-4T/H	A	S	NO	1.00	32.0%	37.7	1.253	10152	14.52	1462
63-4T/L	A	S	NO	1.00	36.0%	41.9	1.170	10263	15.10	1432
63-4M/L	A	S	NO	1.00	34.8%	40.8	1.138	10512	13.85	1445
63-6T/H	A	S	NO	1.00	28.5%	37.6	0.373	6577	5.95	957
63-6T/L	A	S	NO	1.00	29.7%	39.3	0.300	5326	6.13	973
63-6M/L	A	S	NO	1.00	28.4%	37.9	0.314	5389	6.07	969

Acoustic features

The specified values are determined according to free field measurements of pressure and sound levels in dB(A) at an equivalent distance of twice the fan's span plus the impeller's diameter, with a minimum of 1.5 m.

Sound power Lw(A) spectrum in dB(A) via frequency band in Hz.

Model	63	125	250	500	1000	2000	4000	8000	Model	63	125	250	500	1000	2000	4000	8000
25-2/H	39	52	64	68	70	70	66	58	45-6/H	33	47	59	62	64	65	61	52
25-4/H	27	40	52	56	58	58	54	46	50-4/H	46	60	72	75	77	78	74	65
31-2/H	49	62	74	78	80	80	76	68	50-4/L	44	58	70	73	75	76	72	63
31-4/H	30	43	55	59	61	61	57	49	50-6/H	36	50	62	65	67	68	64	55
31-4/L	29	42	54	58	60	60	56	48	56-4/H	49	63	75	78	80	81	77	68
35-2/H	51	64	76	80	82	82	78	70	56-4/L	47	61	73	76	78	79	75	66
35-4/H	33	46	58	62	64	64	60	52	56-6/H	39	53	65	68	70	71	67	58
35-4/L	31	44	56	60	62	62	58	50	63-4/H	61	75	87	90	92	92	89	80
40-4/H	36	49	61	65	67	67	63	55	63-4/L	54	68	80	83	85	85	82	73
40-4/L	35	48	60	64	66	66	62	54	63-6/H	44	58	70	73	75	75	72	63
40-6/H	29	42	54	58	60	60	56	48	63-6/L	42	56	68	71	73	73	70	61
45-4/H	43	57	69	72	74	75	71	62	63-8/H	36	50	62	65	67	67	64	55
45-4/L	41	55	67	70	72	73	69	60									

Dimensions in mm

HEP

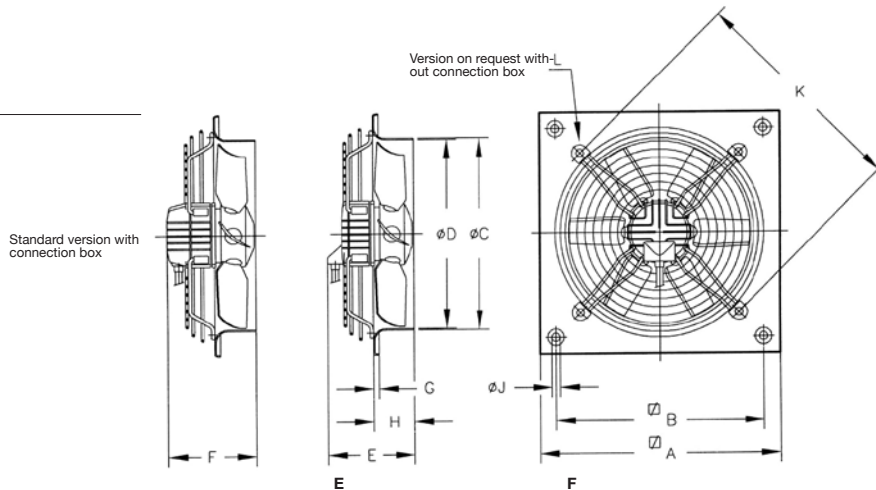

Model	∅A	∅B	∅C	∅D	2T	4T	6T	8T	2T	4T	6T	8T	G	H	∅J	K	L
HEP-25	330	275	262	260	189	179	-	-	213	203	-	-	11	56	8.5	310	M.8
HEP-31.../H	400	336	310.5	308	190	180	-	-	214	204	-	-	11	75	10.5	380	M.8
HEP-31.../L	400	336	310.5	308	-	180	-	-	-	204	-	-	11	75	10.5	380	M.8
HEP-35.../H	465	390	362.5	360	217	187	-	-	241	211	-	-	11	86	10.5	450	M.8
HEP-35.../L	465	390	362.5	360	-	187	-	-	-	211	-	-	11	86	10.5	450	M.8
HEP-40.../H	532	452	412.5	410	-	206	186	-	-	226	205	-	11	97.5	10.5	500	M.8
HEP-40.../L	532	452	412.5	410	-	206	-	-	-	226	-	-	11	97.5	10.5	500	M.8
HEP-45.../H	596	504	462.5	460	-	214	199	-	-	234	218	-	11	105	10.5	560	M.8
HEP-45.../L	596	504	462.5	460	-	214	-	-	-	234	-	-	11	105	10.5	560	M.8
HEP-50.../H	665	562	516.5	514	-	255	235	-	-	275	254	-	11	115	10.5	640	M.8
HEP-50.../L	665	562	516.5	514	-	240	-	-	-	260	-	-	11	115	10.5	640	M.8
HEP-56.../H	710	630	563	560	-	287	247	-	-	306	266	-	15	115	10.5	721	M.8
HEP-56.../L	710	630	563	560	-	267	-	-	-	286	-	-	15	115	10.5	721	M.8
HEP-63.../H	800	710	638	635	-	-	257	247	-	340	276	266	15	140	10.5	820	M.8
HEP-63.../L	800	710	638	635	-	320	247	-	-	340	266	-	15	140	10.5	820	M.8

Dimensions in mm

HEPT

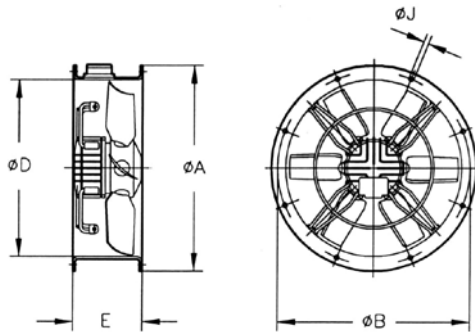

Model	ϕA	ϕB	ϕD	E	ϕJ	Drills No
HEPT-31	385	355	308	200	10	8
HEPT-35	425	395	360	220	10	8
HEPT-40	490	450	410	220	12	8
HEPT-45	540	500	460	220	12	8
HEPT-50	600	560	514	230	12	12
HEPT-56	660	620	560	260	12	12
HEPT-63	730	690	635	350	12	12

Characteristic curves

Q = Airflow in m³/h, m³/s and cfm.

Pe = Static pressure in mmH₂O, Pa and inwg.

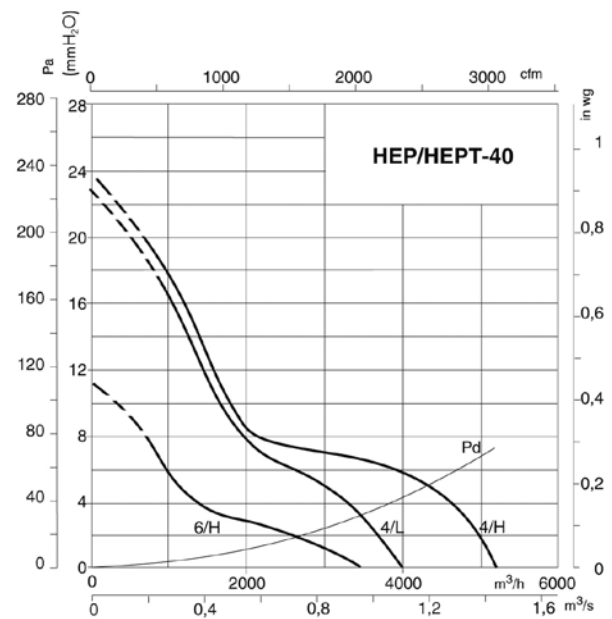
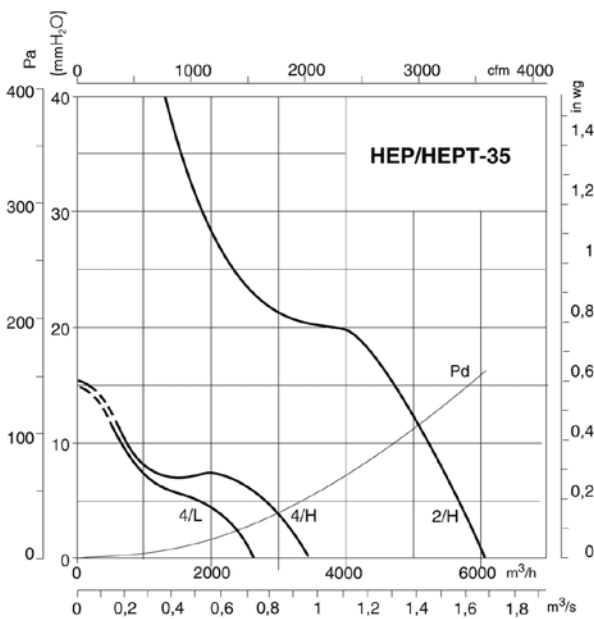
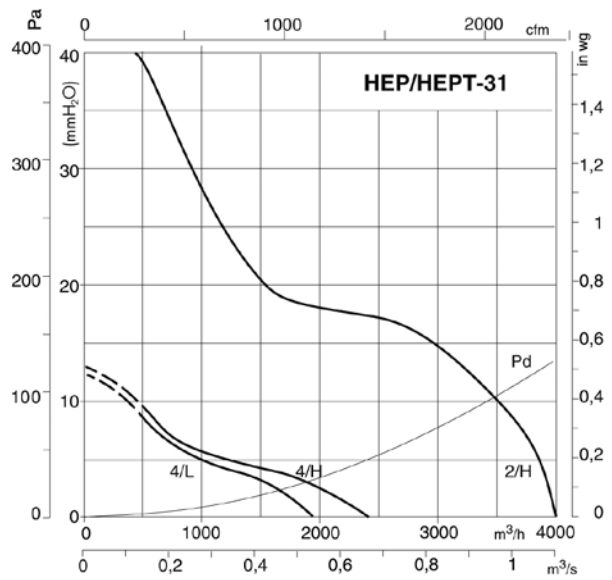
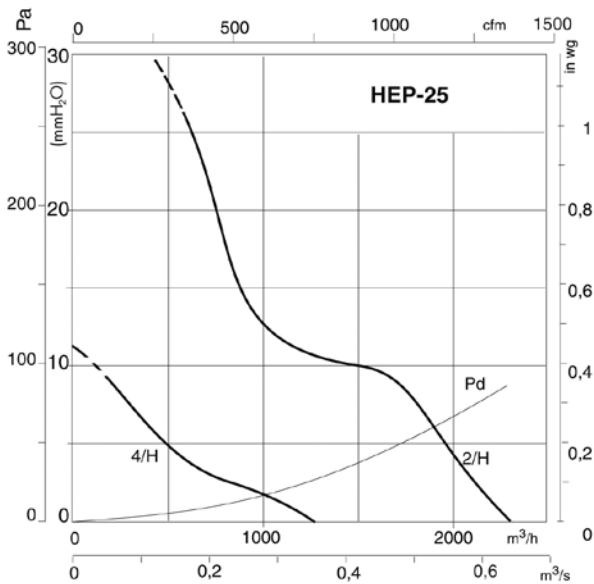

Characteristic curves

Q = Airflow in m³/h, m³/s and cfm.

Pe= Static pressure in mmH₂O, Pa and inwg.

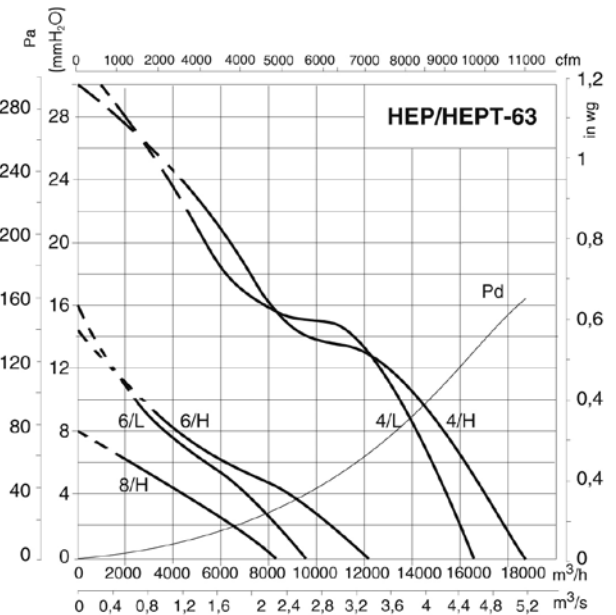
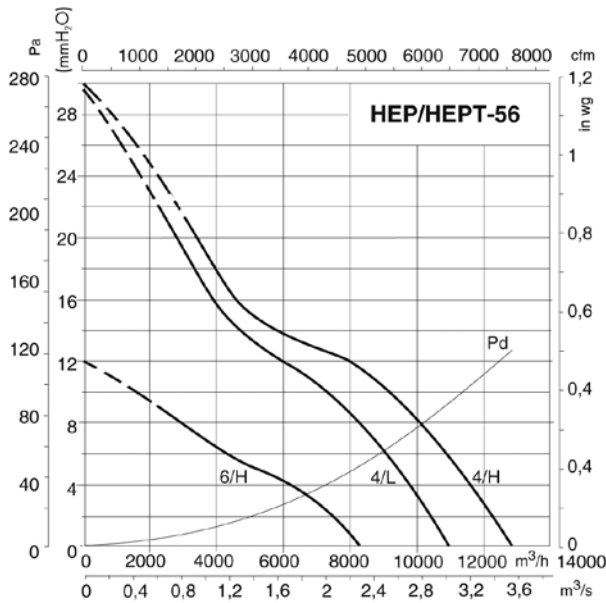
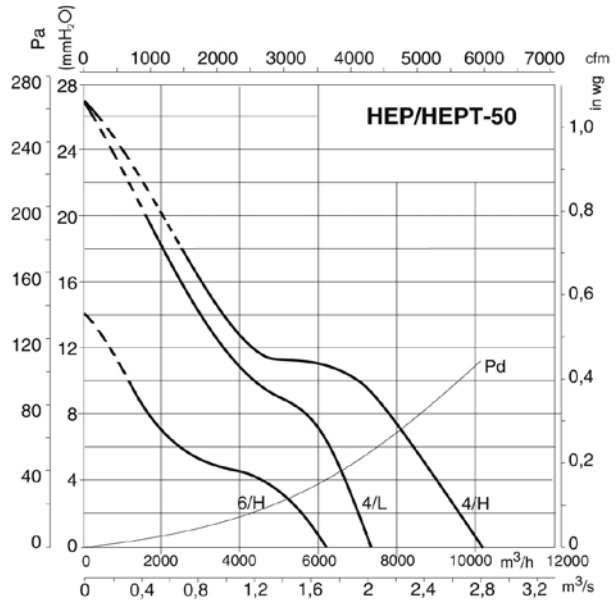
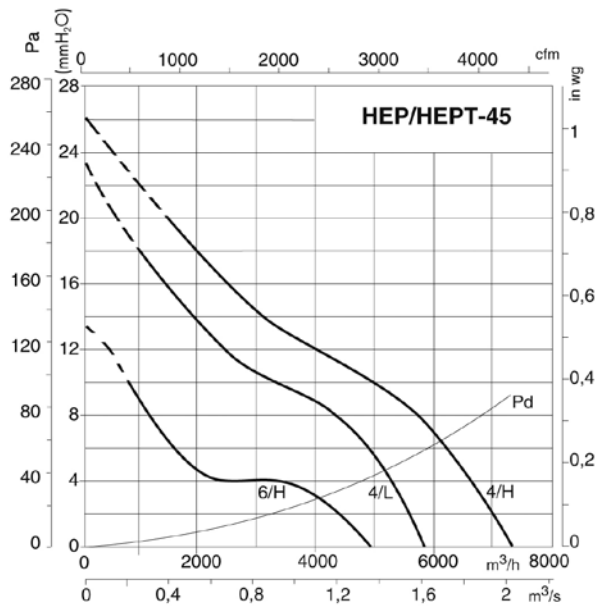

Accessories

See accessories section.



HC



Wall-mounted axial fans, with IP55 motor

Wall-mounted axial fans with fibreglass-reinforced plastic impeller



HC



HC
71, 80,
90,100

Fan:

- Sheet steel base plate.
- Impeller in polyamide 6 reinforced with fibre glass
- Protection guard to prevent contacts according to standard UNE-EN ISO 12499:2010
- Models 71, 80, 90 and 100, the protective grille is supplied as an accessory
- Airflow direction from motor to impeller

Motor:

- IE2 efficiency motors for capacities equal to or over 0.75kW and below 7.5kW, except single-phase, 2 speed and 8 pole motors.
- Class F motors, with ball bearings and IP55 protection, except single-phase versions from size 45 to size 63, IP54 protection, one- or two-speed depending on the model
- Single-phase 230V-50Hz and Three-phase 230/400V-50Hz (up to 4kW) and 400/690V-50Hz (power over 4kW)
- Fan working temperature: -25°C + 60°C

Finish:

- Anticorrosive finish in polyester resin polymerised at 190°C, after degreasing with phosphate-free nanotechnology treatment.

On request:

- Motor, impeller and guard unit (version F)
- Motor-impeller unit, version G.
- Airflow direction from impeller to motor.
- Special windings for different voltages.

Order code

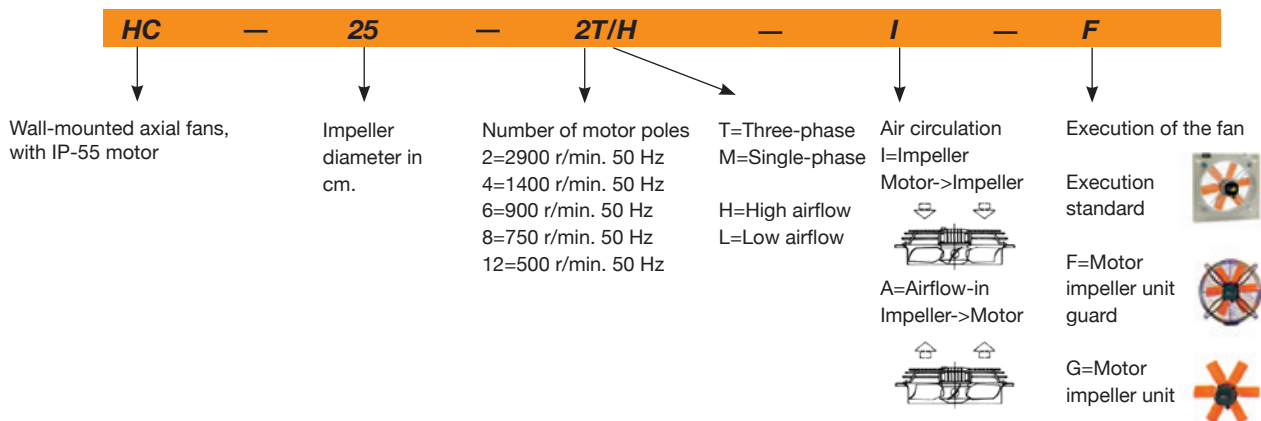

Technical characteristics

Model	Speed (r/min)	Maximum admissible current (A)			Installed capacity (kW)	Maximum airflow (m3/h)	Sound pressure level dB(A)	Approx. weight (Kg)
		230V	400V	690V				
HC-25-2T/H	2730	0.74	0.43	0.12	2200	64	5	
HC-25-2M/H	2770	0.98		0.12	2200	64	5	
HC-25-4T/H	1320	0.96	0.56	0.10	1300	51	5	
HC-25-4M/H	1380	0.65		0.10	1300	51	5	
HC-31-2T/H	2750	1.21	0.70	0.18	3650	72	6	
HC-31-2M/H	2700	1.85		0.18	3600	72	6	
HC-31-4T/H	1320	0.96	0.56	0.10	2400	54	6	
HC-31-4M/H	1380	1.03		0.10	2400	54	6	
HC-31-4T/L	1320	0.65	0.38	0.08	1800	52	6	
HC-31-4M/L	1380	0.65		0.10	1750	52	6	

Technical characteristics

Model	Speed (r/min)	Maximum admissible current (A)			Installed capacity (kW)	Maximum airflow (m3/h)	Sound pressure level dB(A)	Approx. weight (Kg)
		230V	400V	690V				
HC-35-2T/H	2710	1.92	1.11		0.37	6050	76	8
HC-35-4T/H	1320	0.96	0.56		0.10	3550	58	7
HC-35-4M/H	1380	1.03			0.10	3550	58	7
HC-35-4T/L	1320	0.96	0.56		0.10	2600	56	7
HC-35-4M/L	1380	0.65			0.10	2600	56	7
HC-40-4T/H	1350	1.66	0.96		0.25	5200	63	10
HC-40-4M/H	1370	2.00			0.25	5200	63	10
HC-40-4T/L	1320	0.96	0.56		0.10	4050	59	8
HC-40-4M/L	1380	1.03			0.10	4050	59	8
HC-40-6T/H	900	1.51	0.87		0.25	3700	55	10
HC-40-6M/H	970	1.30			0.25	3700	55	10
HC-45-4T/H	1370	2.02	1.17		0.37	7300	66	14
HC-45-4M/H	1400	2.76			0.37	7300	66	14
HC-45-4T/L	1350	1.66	0.96		0.25	5600	63	11
HC-45-4M/L	1370	2.00			0.25	5600	63	11
HC-45-6T/H	900	1.51	0.87		0.25	5150	57	14
HC-45-6M/H	950	1.50			0.25	5150	57	14
HC-50-4T/H	1380	2.92	1.69		0.55	10200	69	18
HC-50-4M/H	1350	5.02			0.55	10200	69	18
HC-50-4T/L	1350	1.66	0.96		0.25	7400	66	12
HC-50-4M/L	1370	2.00			0.25	7400	66	12
HC-50-6T/H	900	2.24	1.30		0.37	6300	59	18
HC-50-6M/H	900	2.69			0.37	6300	59	18
HC-56-4T/H	1400	4.03	2.32		1.10	13000	72	24
HC-56-4/8T/H	1440 / 710		2.9 / 1.3		1.10/0.25	13000/6500	72/57	24
HC-56-4T/L	1380	2.92	1.69		0.55	11050	70	18
HC-56-4M/L	1380	4.60			0.55	11050	70	18
HC-56-6T/H	900	2.24	1.30		0.37	8300	61	19
HC-56-6M/H	900	2.69			0.37	8300	61	19
HC-63-4T/H	1400	4.03	2.32		1.10	16450	74	26
HC-63-4/8T/H	1440 / 710		2.9 / 1.3		1.10/0.25	16450/8225	74/59	26
HC-63-4T/L	1410	3.10	1.79		0.75	14400	73	19
HC-63-4M/L	1430	4.78			0.55	14400	73	19
HC-63-6T/H	900	2.24	1.30		0.37	12350	64	21
HC-63-6M/H	890	3.00			0.37	12350	64	21
HC-71-4T/H	1430	5.96	3.44		1.50	22150	78	35
HC-71-4/8T/H	1420 / 700		3.5 / 1.5		1.50/0.37	22200/11100	78/63	35
HC-71-6T/H	945	3.90	2.20		0.75	17300	66	36
HC-71-6/12T/H	935 / 435		2.2 / 0.87		0.75/0.15	17350/8675	66/51	35
HC-71-6M/H	900	4.97			0.75	15600	65	36
HC-80-4T/H	1445	10.96	6.33		3.00	33000	82	55
HC-80-4/8T/H	1430 / 710		6.5 / 2.3		3.00/0.60	33000/16500	82/67	53
HC-80-4T/L	1430	5.96	3.44		1.50	25000	79	44
HC-80-6T/H	945	3.90	2.20		0.75	22000	71	45
HC-80-6/12T/H	935 / 435		2.2 / 0.87		0.75/0.15	22000/11000	71/56	44
HC-80-6T/L	900	2.99	1.73		0.55	19200	70	39
HC-90-4T/H	1440	14.10	8.12		4.00	43700	86	68
HC-90-4/8T/H	1430 / 710		8.2 / 2.9		4.00/0.80	43700/21850	86/69	74
HC-90-4T/L	1445	10.96	6.33		3.00	33700	83	63
HC-90-6T/H	955	6.42	3.71		1.50	33300	76	60
HC-90-6/12T/H	970 / 470		4.6 / 1.9		1.50/0.25	33300/16650	76/61	70
HC-90-6T/L	945	4.88	2.82		1.10	26550	73	55
HC-90-8T/H	695	3.53	2.04		0.55	19800	69	54
HC-100-4T/H	1440		11.60	6.72	5.50	54000	88	85
HC-100-4/8T/H	1450 / 720		11.8 / 3.8		5.50/1.10	54000/27000	88/73	95
HC-100-4T/L	1440	14.10	8.12		4.00	42750	84	71
HC-100-6T/H	955	6.42	3.71		1.50	37000	78	63
HC-100-6/12T/H	970 / 470		4.6 / 1.9		1.50/0.25	37000/18500	78/63	73
HC-100-6T/L	945	4.88	2.82		1.10	29000	76	58
HC-100-8T/H	705	4.68	2.70		0.75	26950	72	61



Erp. BEP (best efficiency point) characteristics

MC	Measurement category	ηe[%]	Efficiency
EC	Efficiency category	N	Degree of efficiency
S	Static	[kW]	Electrical power
T	Total	[m³/h]	Airflow
VSD	Variable-speed drive	[mmH₂O]	Static or total pressure (According to EC)
SR	Specific relationship	[RPM]	Speed

Modelo	MC	EC	VSD	SR	ηe [%]	N	[kW]	[m3/h]	[mmH ₂ O]	[RPM]
HC-25-4T/H	-	-	-	-	-	-	0.099	707	5.15	1407
HC-25-4M/H	-	-	-	-	-	-	0.102	693	5.24	1432
HC-31-2T/H	A	S	NO	1.00	28.7%	38.5	0.284	1781	16.86	2743
HC-31-2M/H	A	S	NO	1.00	27.9%	37.5	0.296	1764	17.16	2783
HC-31-4T/H	-	-	-	-	-	-	0.110	1392	6.66	1397
HC-31-4M/H	-	-	-	-	-	-	0.116	1388	6.68	1423
HC-31-4T/L	-	-	-	-	-	-	0.099	922	6.81	1389
HC-31-4M/L	-	-	-	-	-	-	0.104	948	6.44	1432
HC-35-2T/H	A	S	NO	1.00	35.6%	43.4	0.584	3352	22.79	2703
HC-35-4T/H	A	S	NO	1.00	31.5%	43.1	0.144	2044	8.13	1365
HC-35-4M/H	A	S	NO	1.00	26.3%	37.5	0.172	2028	8.19	1387
HC-35-4T/L	-	-	-	-	-	-	0.115	1466	6.79	1393
HC-35-4M/L	-	-	-	-	-	-	0.123	1502	6.63	1419
HC-40-4T/H	A	S	NO	1.00	29.8%	39.5	0.290	3617	8.79	1395
HC-40-4M/H	A	S	NO	1.00	28.0%	37.5	0.311	3713	8.63	1406
HC-40-4T/L	A	S	NO	1.00	30.6%	41.7	0.174	2394	8.17	1337
HC-40-4M/L	A	S	NO	1.00	26.7%	37.5	0.199	2375	8.23	1369
HC-45-4T/H	A	S	NO	1.00	36.3%	45.0	0.423	4282	13.18	1403
HC-45-4M/H	A	S	NO	1.00	31.4%	39.7	0.490	4333	13.05	1418
HC-45-4T/L	A	S	NO	1.00	31.9%	41.7	0.283	3635	9.12	1398
HC-45-4M/L	A	S	NO	1.00	28.1%	37.5	0.322	3728	8.93	1403
HC-45-6T/H	A	S	NO	1.00	28.8%	39.7	0.190	2675	7.51	935
HC-45-6M/H	A	S	NO	1.00	26.8%	37.5	0.205	2819	7.17	953
HC-50-4T/H	A	S	NO	1.00	34.2%	41.8	0.611	5349	14.34	1412
HC-50-4M/H	A	S	NO	1.00	29.7%	37.0	0.708	5551	13.90	1418
HC-50-4T/L	A	S	NO	1.00	40.8%	49.9	0.360	4320	12.50	1370
HC-50-4M/L	A	S	NO	1.00	37.2%	46.0	0.395	4120	13.08	1381
HC-56-4T/H	A	S	NO	1.00	35.8%	41.9	1.066	8315	16.85	1421
HC-56-4/8T/H	A	S	NO	1.00	31.9%	37.7	1.205	8515	16.59	1454
HC-56-4T/L	A	S	NO	1.00	38.7%	46.1	0.661	7355	12.76	1405
HC-56-4M/L	A	S	NO	1.00	38.1%	45.6	0.673	7501	12.57	1422
HC-56-6T/H	A	S	NO	1.00	32.6%	41.8	0.353	5086	8.30	941
HC-56-6M/H	A	S	NO	1.00	28.7%	37.6	0.402	5247	8.09	929
HC-63-4T/H	C	S	NO	1.00	40.1%	46.0	1.164	9340	18.35	1413
HC-63-4/8T/H	C	S	NO	1.00	32.4%	37.8	1.429	9621	17.69	1445
HC-63-4T/L	C	S	NO	1.00	40.7%	47.6	0.806	8607	14.00	1423
HC-63-4M/L	C	S	NO	1.00	33.3%	39.7	0.986	8333	14.47	1385
HC-63-6T/H	C	S	NO	1.00	33.4%	41.5	0.521	7201	8.89	913
HC-63-6M/H	C	S	NO	1.00	31.7%	39.6	0.554	7578	8.51	903
HC-71-4T/H	C	S	NO	1.00	42.0%	46.8	1.793	13627	20.31	1431
HC-71-4/8T/H	C	S	NO	1.00	37.6%	42.0	2.034	13456	20.90	1421
HC-71-6T/H	C	S	NO	1.00	34.4%	41.9	0.667	9443	8.94	963
HC-71-6/12T/H	C	S	NO	1.00	30.7%	37.7	0.798	10137	8.89	953
HC-71-6M/H	C	S	NO	1.00	29.4%	36.4	0.772	10923	7.63	929
HC-80-4T/H	C	S	NO	1.00	48.4%	51.5	3.247	19996	28.89	1449
HC-80-4/8T/H	C	S	NO	1.00	42.8%	45.5	3.680	20166	28.66	1433
HC-80-4T/L	C	S	NO	1.00	50.1%	54.8	1.814	12760	26.16	1430
HC-80-6T/H	C	S	NO	1.00	44.3%	50.8	0.935	12533	12.14	948
HC-80-6/12T/H	C	S	NO	1.00	39.8%	46.0	1.041	12670	12.02	939
HC-80-6T/L	C	S	NO	1.00	46.3%	53.3	0.802	10262	13.31	902
HC-90-4T/H	C	S	NO	1.00	49.2%	52.0	3.650	24299	27.16	1452
HC-90-4/8T/H	C	S	NO	1.00	43.0%	45.4	4.191	24026	27.54	1439
HC-90-4T/L	C	S	NO	1.00	45.7%	49.1	2.923	19552	25.10	1454
HC-90-6T/H	C	S	NO	1.00	40.2%	45.1	1.640	15731	15.38	961
HC-90-6/12T/H	C	S	NO	1.00	37.1%	41.8	1.778	15887	15.24	974
HC-90-6T/L	C	S	NO	1.00	41.5%	47.1	1.301	14635	13.55	949
HC-90-8T/H	C	S	NO	1.00	39.2%	46.7	0.667	11772	8.16	707
HC-100-4T/H	C	S	NO	1.00	47.2%	48.6	5.992	28190	36.83	1442
HC-100-4/8T/H	C	S	NO	1.00	42.8%	43.9	6.592	28757	36.01	1453
HC-100-4T/L	C	S	NO	1.00	49.9%	52.0	4.634	23348	36.36	1440
HC-100-6T/H	C	S	NO	1.00	50.5%	55.1	1.905	20265	17.44	954
HC-100-6/12T/H	C	S	NO	1.00	48.3%	52.8	1.992	20356	17.37	971
HC-100-6T/L	C	S	NO	1.00	49.3%	54.8	1.342	17161	14.17	948
HC-100-8T/H	C	S	NO	1.00	37.8%	44.1	1.023	16029	8.86	709

Dimensions in mm

HC 25...63

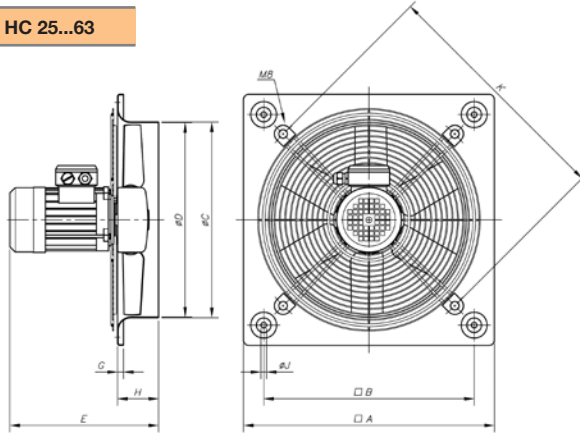

HC 71...100

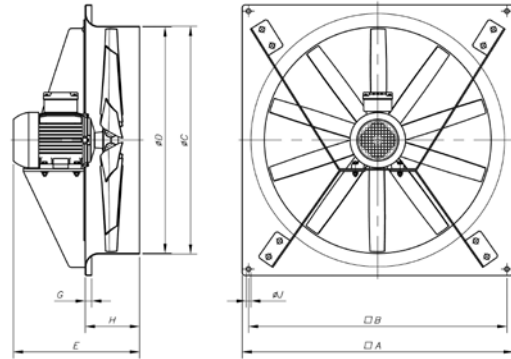

Model	ØA	ØB	ØC	ØD	E	G	H	ØJ	K
HC-25	330	275	262	260	236.5	11	56	8.5	310
HC-31-2	400	336	310.5	308	264.5	11	65	10.5	380
HC-31-4	400	336	310.5	308	245.5	11	65	10.5	380
HC-35-2	465	390	362.5	360	275.5	11	76	10.5	450
HC-35-4	465	390	362.5	360	256.5	11	76	10.5	450
HC-40-4.../H	532	452	412.5	410	297.5	11	97.5	10.5	500
HC-40-4.../L	532	452	412.5	410	278.5	11	97.5	10.5	500
HC-40-6.../H	532	452	412.5	410	308.5	11	97.5	10.5	500
HC-45-4.../H	596	504	462.5	460	315.5	11	105	10.5	560
HC-45-4.../L	596	504	462.5	460	304.5	11	105	10.5	560
HC-45-6.../H	596	504	462.5	460	315.5	11	105	10.5	560
HC-50-4T/H	665	562	516.5	514	325.5	11	115	10.5	640
HC-50-4M/H	665	562	516.5	514	351	11	115	10.5	640
HC-50-4.../L	665	562	516.5	514	283.5	11	115	10.5	640
HC-50-6.../H	665	562	516.5	514	351	11	115	10.5	640
HC-56-4T/H	710	630	563	560	374	15	115	10.5	721
HC-56-4T/L	710	630	563	560	325.5	15	115	10.5	721
HC-56-4M/L	710	630	563	560	351	15	115	10.5	721
HC-56-6.../H	710	630	563	560	351	15	115	10.5	721
HC-63-4T/H	800	710	638	635	399	15	140	10.5	820
HC-63-4.../L	800	710	638	635	376	15	140	10.5	820
HC-63-6.../H	800	710	638	635	376	15	140	10.5	820

Model	ØA	ØB	ØC	ØD	E	G	H	ØJ
HC-71-4T/H	850	810	715	711	395	20	170	14.5
HC-71-6T/H	850	810	715	711	395	20	170	14.5
HC-80-4T/H	970	910	801	797	488	20	210	14.5
HC-80-4T/L	970	910	801	797	458	20	210	14.5
HC-80-6T/H	970	910	801	797	458	20	210	14.5
HC-80-6T/L	970	910	801	797	416	20	210	14.5
HC-90-4T/H	1170	1110	918	914	511	20	210	14.5
HC-90-4T/L	1170	1110	918	914	488	20	210	14.5
HC-90-6T/H	1170	1110	918	914	488	20	210	14.5
HC-90-6T/L	1170	1110	918	914	455	20	210	14.5
HC-90-8T/H	1170	1110	918	914	455	20	210	14.5
HC-100-4T/H	1170	1110	1003	999	548	20	220	14.5
HC-100-4T/L	1170	1110	1003	999	521	20	220	14.5
HC-100-6T/H	1170	1110	1003	999	498	20	220	14.5
HC-100-6T/L	1170	1110	1003	999	468	20	220	14.5
HC-100-8T/H	1170	1110	1003	999	498	20	220	14.5

Acoustic features

The specified values are determined according to free field measurements of pressure and sound levels in dB(A) at an equivalent distance of twice the fan's span plus the impeller's diameter, with a minimum of 1.5 m.

Sound power Lw(A) spectrum in dB(A) via frequency band in Hz.

Model	63	125	250	500	1000	2000	4000	8000	Model	63	125	250	500	1000	2000	4000	8000
25-2/H	38	48	65	65	73	69	62	53	63-4/L	48	63	73	78	84	85	81	74
25-4/H	25	35	52	52	60	56	49	40	71-4/H	47	64	77	84	89	90	85	78
31-2/H	46	56	73	73	81	77	70	61	71-6T/H	35	52	65	72	77	78	73	66
31-4/H	28	38	55	55	63	59	52	43	71-6M/H	34	51	64	71	76	77	72	65
31-4/L	26	36	53	53	61	57	50	41	71-8/H	32	49	62	69	74	75	70	63
35-2/H	50	60	77	77	85	81	74	65	71-12/H	20	37	50	57	62	63	58	51
35-4/H	32	42	59	59	67	63	56	47	80-4/H	60	81	88	93	96	92	85	74
35-4/L	30	40	57	57	65	61	54	45	80-6/H	49	70	77	82	85	81	74	63
40-4/H	28	45	57	65	70	70	66	59	80-8/H	45	66	73	78	81	77	70	59
40-4/L	29	45	55	59	66	66	62	55	80-12/H	34	55	62	67	70	66	59	48
40-6/H	20	37	49	57	62	62	58	51	80-4/L	57	78	85	90	93	89	82	71
45-4/H	33	50	63	70	75	76	71	64	80-6/L	48	69	76	81	84	80	73	62
45-4/L	36	51	61	66	72	73	69	62	90-4/H	64	85	92	97	100	96	89	78
45-6/H	24	41	54	61	66	67	62	55	90-6/H	54	75	82	87	90	86	79	68
50-4/H	36	53	66	73	78	79	74	67	90-8/H	47	68	75	80	83	79	72	61
50-4/L	39	54	64	69	75	76	72	65	90-12/H	39	60	67	72	75	71	64	53
50-6/H	26	43	56	63	68	69	64	57	90-4/L	61	82	89	94	97	93	86	75
56-4/H	39	56	69	76	81	82	77	70	90-6/L	51	72	79	84	87	83	76	65
56-6/H	28	45	58	65	70	71	66	59	100-4/H	68	88	96	101	103	100	93	82
56-8/H	24	41	54	61	66	67	62	55	100-6/H	58	78	86	91	93	90	83	72
56-4/L	43	58	68	73	79	80	76	69	100-8/H	52	72	80	85	87	84	77	66
63-4/H	43	60	73	80	85	86	81	74	100-12/H	43	63	71	76	78	75	68	57
63-6/H	33	50	63	70	75	76	71	64	100-4/L	64	84	92	97	99	96	89	78
63-8/H	28	45	58	65	70	71	66	59	100-6/L	56	76	84	89	91	88	81	70

Characteristic curves

Q = Airflow in m³/h, m³/s and cfm.

Pe = Static pressure in mmH₂O, Pa and inwg.

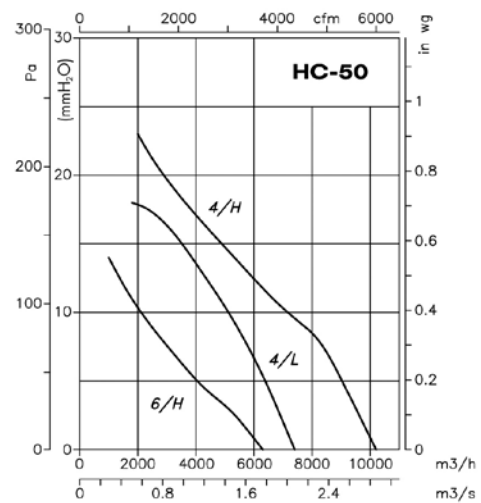
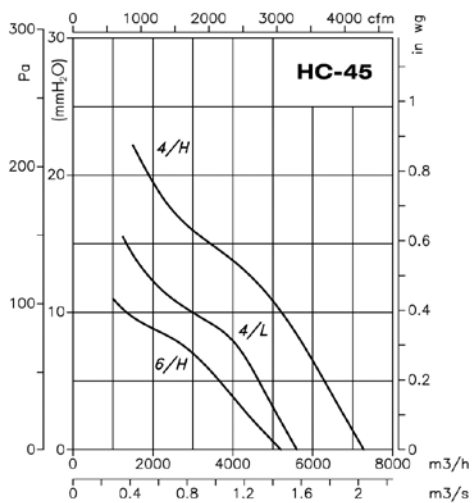
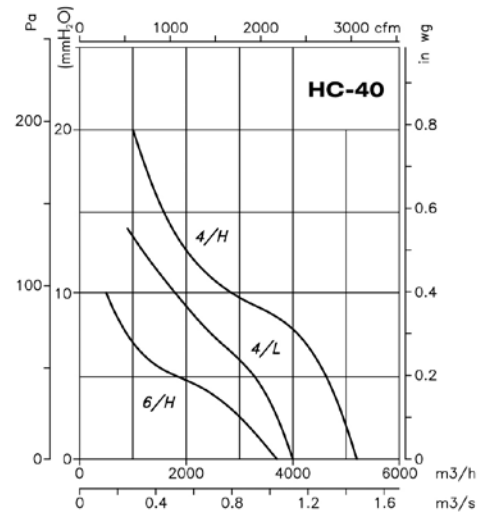
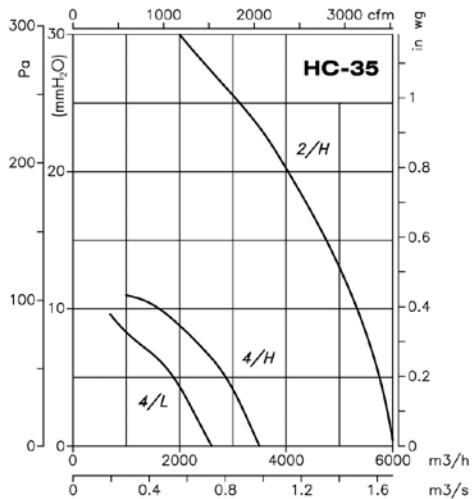
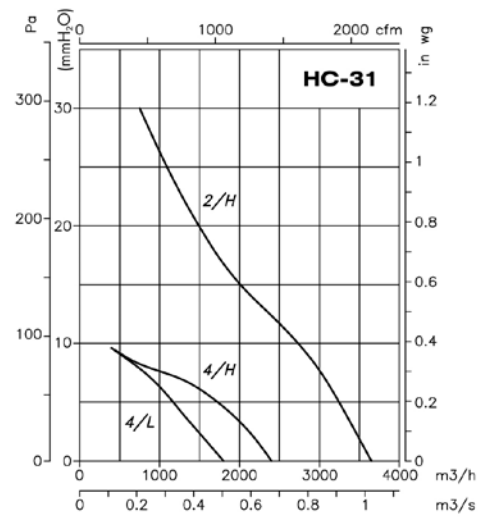
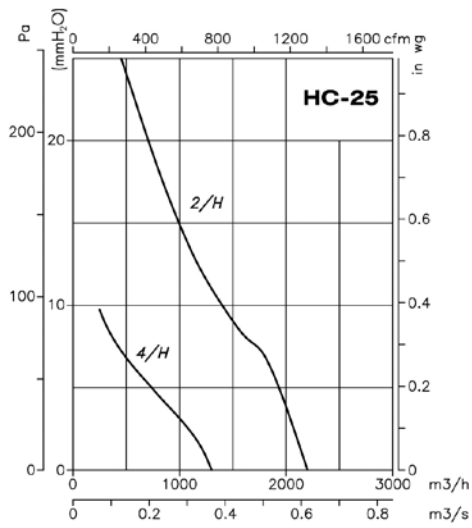

Characteristic curves

Q = Airflow in m³/h, m³/s and cfm.

Pe= Static pressure in mmH₂O, Pa and inwg.

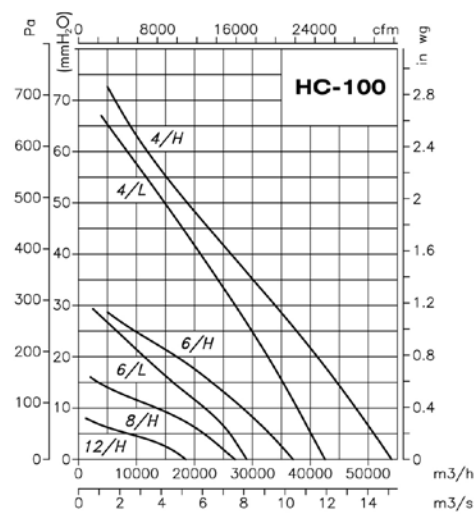
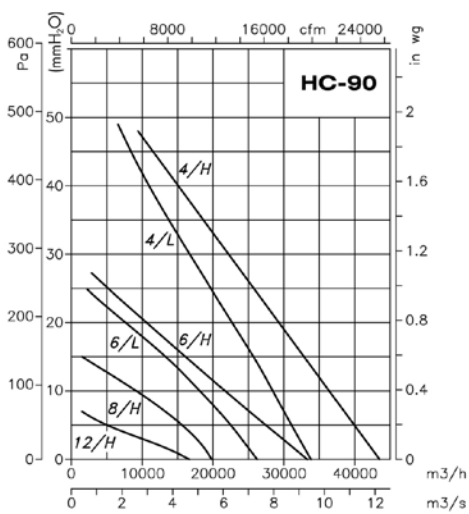
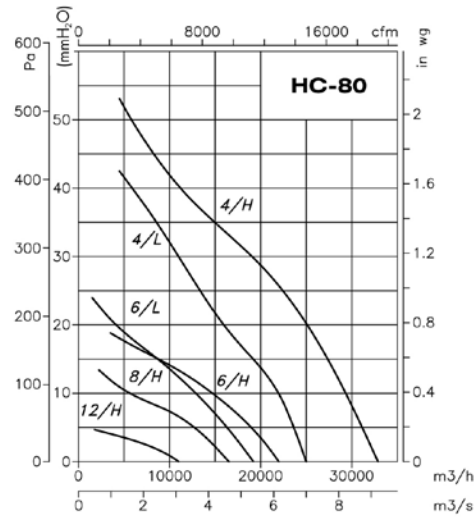
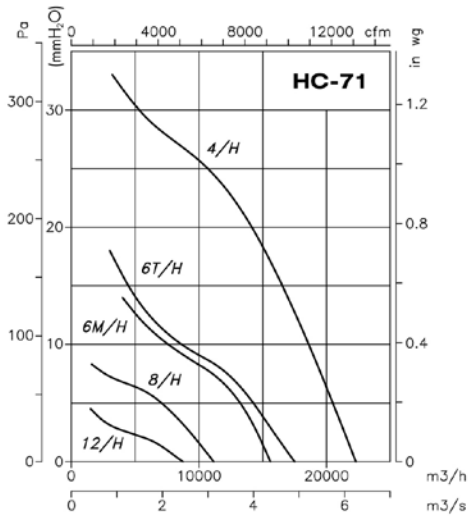
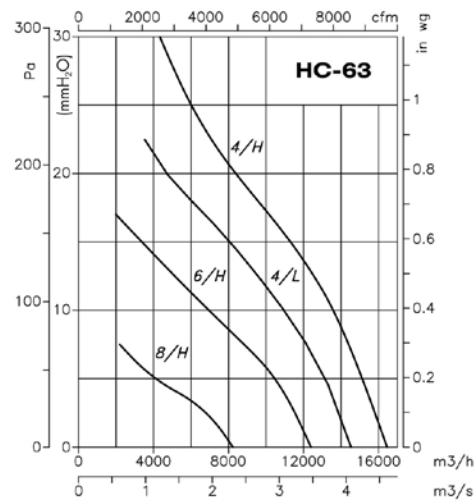
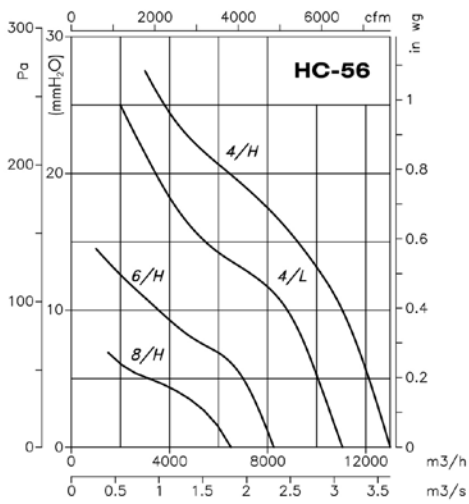

Accessories

See accessories section.



INT

RM

C2V

AR

VSD3/A-RFT
VSD1/A-RFM

CUADROS

PL

P

R

RI

S

SI

HCD



Small-diameter wall-mounted axial fans



Wall-mounted axial fans with aluminium sheet impellers, shading ring motors and built-in connection cable.

Fan:

- Sheet steel base plate.
- Aluminium sheet impeller
- Protection guard to prevent contacts according to standard UNE-EN ISO 12499:2010
- Airflow direction from motor to impeller

Motor:

- Class B motors with dry friction bearings, IP44 protection, except model 40 supplied with class F motor, ball bearings, IP54 protection
- Single-phase 230V.-50Hz.
- Fan working temperature: -30°C + 50°C

Finish:

- Anticorrosive finish in polyester resin polymerised at 190°C, after degreasing with phosphate-free nanotechnology treatment.

On request:

- Special windings for different voltages

Order code

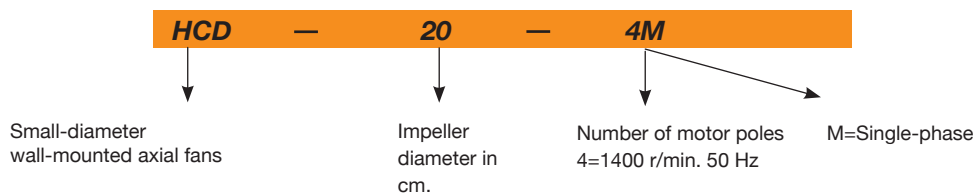

Technical characteristics

Model	Speed (r/min)	Max. current admissible (A) 230V	Absorbed power at free airflow (W)	Maximum airflow (m3/h)	Sound pressure level dB(A)	Approx. weight (Kg)
HCD-20-4M	1350	0.21	36	560	38	1.15
HCD-25-4M	1340	0.25	41	960	43	1.60
HCD-30-4M	1360	0.51	76	1350	48	2.15
HCD-35-4M	1365	0.80	115	1820	53	6.20
HCD-40-4M	1410	1.00	150	3100	57	7.20



Erp. BEP (best efficiency point) characteristics

MC	Measurement category	ηe[%]	Efficiency
EC	Efficiency category	N	Degree of efficiency
S	Static	[kW]	Electrical power
T	Total	[m³/h]	Airflow
VSD	Variable-speed drive	[mmH₂O]	Static or total pressure (According to EC)
SR	Specific relationship	[RPM]	Speed

Model	MC	EC	VSD	SR	ηe [%]	N	[kW]	[m3/h]	[mmH ₂ O]	[RPM]
HCD-20-4M	A	S	-	-	-	-	0.029	399	1.80	1403
HCD-25-4M	A	S	-	-	-	-	0.036	545	2.78	1386
HCD-30-4M	A	S	-	-	-	-	0.080	762	4.79	1397
HCD-35-4M	A	S	-	-	-	-	0.123	906	7.30	1384
HCD-40-4M	A	S	NO	1.00	25.9%	37.43	0.149	1845	7.70	1390

Dimensions in mm

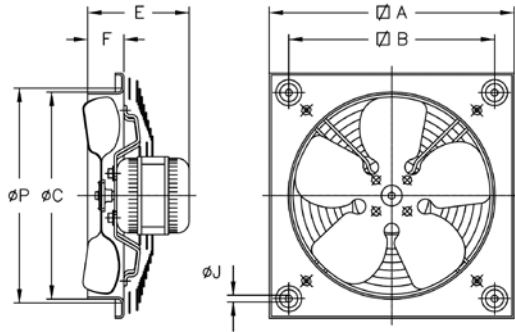

Model	∅A	∅B	∅C	E	F	∅J	∅P
HCD-20	266	222	211	104.5	34	9	240
HCD-25	330	275	262	105.5	56	10.5	290
HCD-30	400	336	311	153	75	10.5	348
HCD-35	465	390	363	166	86	10.5	410
HCD-40	532	452	413	276	97.5	10.5	460

Characteristic curves

Q = Airflow in m³/h, m³/s and cfm.

Pe = Static pressure in mmH₂O, Pa and inwg.

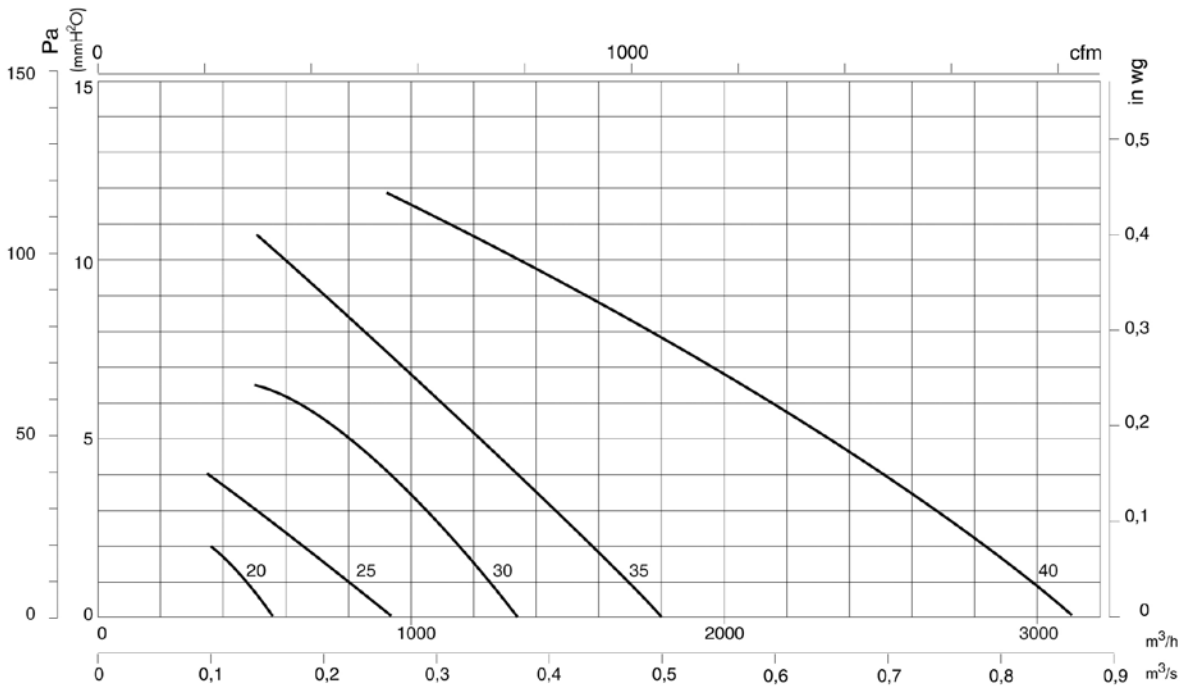

Accessories

See accessories section.



INT

RM

PL

P

RI

SI



HRE HCRE

**HRE: Circular axial fans
with external rotor motor**
HCRE: Wall-mounted axial fans

Wall-mounted axial fans with support and blades in sheet steel, especially designed to obtain high energy efficiency.



HRE



HCRE

Fan:

- HRE: Support ring in sheet steel
- HCRE: Sheet steel base plate.
- Protection guard to prevent contacts according to standard UNE-EN ISO 12499:2010
- Sheet steel impeller
- Airflow direction from protection guard to impeller

Motor:

- Class F and B motors, with ball bearings, IP-54 protection
- High-efficiency external rotor motors
- Single-phase 230V.50Hz. and three-phase 400V.50Hz.
- Fan working temperature: -30°C +60°C

Finish:

- Anticorrosive finish in polyester resin polymerised at 190°C, after degreasing with phosphate-free nanotechnology treatment.

Order code



HRE: Circular axial fans with external rotor motor
HCRE: Wall-mounted axial fans with external rotor motor

Impeller diameter in cm.

Number of motor poles
2=2900 r/min. 50 Hz
4=1400 r/min. 50 Hz
6=900 r/min. 50 Hz
8=750 r/min. 50 Hz

T=Three-phase
M=Single-phase

Technical characteristics

Model	Speed (r/min)	Max. current admissible (A)		Max. electric power (kW)	Maximum airflow (m³/h)	Sound pressure level dB(A)	Approx. weight (Kg)
		230V	400V				
HRE-25-2T	2430		0.18	0.090	1330	56	3.0
HRE-25-2M	2480	0.45		0.100	1330	56	3.0
HRE-25-4T	1400		0.18	0.060	750	53	3.0
HRE-25-4M	1400	0.25		0.050	750	53	3.0
HRE-31-2T	2500		0.25	0.115	1850	59	3.3
HRE-31-2M	2400	0.55		0.125	1850	58	3.3
HRE-31-4T	1380		0.25	0.090	1400	54	3.3
HRE-31-4M	1350	0.42		0.090	1400	54	3.3
HRE-35-4T	1360		0.30	0.140	2670	58	5.0
HRE-35-4M	1380	0.60		0.140	2670	58	5.0

Technical characteristics

Model	Speed (r/min)	Max. current admissible (A)		Max. absorbed power (W)	Maximum airflow (m³/h)	Approx. weight (Kg)
		230V	400V			
HCRE 40-4T	1370	-	0.50	190	3800	6.0
HCRE 40-4M	1350	0.90	-	190	3800	6.0
HCRE 45-4T	1380	-	0.65	290	4500	7.5
HCRE 45-4M	1350	1.10	-	300	4500	7.5
HCRE 45-6T	910	-	0.18	165	2800	7.5
HCRE 50-4T	1350	-	0.85	420	6250	10
HCRE 50-4M	1320	2.00	-	420	6250	10
HCRE 50-6T	920	-	0.62	220	4320	10
HCRE 50-6M	920	1.10	-	220	4320	10
HCRE 56-4T	1330	-	1.10	550	7500	10.5
HCRE 56-4M	1300	2.50	-	530	7500	10.5
HCRE 56-6T	910	-	0.85	320	6500	10.5
HCRE 56-6M	910	1.50	-	320	6500	10.5
HCRE 63-4T	1350	-	1.60	850	10800	15.4
HCRE 63-4M	1360	3.70	-	800	10800	15.4
HCRE 63-6T	900	-	1.40	550	9300	15.4
HCRE 63-6M	900	2.50	-	520	9300	15.4
HCRE 71-6T	910	-	2.00	1100	15500	25



Erp. BEP (best efficiency point) characteristics

MC	Measurement category	ne[%]	Efficiency
EC	Efficiency category	N	Degree of efficiency
S	Static	[kW]	Electrical power
T	Total	[m³/h]	Airflow
VSD	Variable-speed drive	[mmH₂O]	Static or total pressure (According to EC)
SR	Specific relationship	[RPM]	Speed

Model	MC	EC	VSD	SR	ηe [%]	N	[kW]	[m³/h]	[mmH ₂ O]	[RPM]
HRE-25-4T	A	S	-	-	-	-	0.061	621	6.37	1434
HRE-25-4M	A	S	-	-	-	-	0.064	587	6.85	1431
HRE-31-2T	A	S	NO	1.00	30.8%	41.7	0.185	1500	13.90	2719
HRE-31-2M	A	S	NO	1.00	26.9%	37.5	0.210	1527	13.57	2681
HRE-31-4T	A	S	-	-	-	-	0.098	933	7.69	1344
HRE-31-4M	A	S	-	-	-	-	0.077	608	13.48	1377
HRE-35-4T	A	S	-	-	-	-	0.116	1309	8.09	1389
HRE-35-4M	A	S	-	-	-	-	0.120	1317	8.03	1385
HCRE-40-4T	A	S	NO	1.00	26.2%	38.1	0.127	2437	5.00	1413
HCRE-40-4M	A	S	NO	1.00	24.9%	36.8	0.133	2384	5.12	1395
HCRE-45-4T	A	S	NO	1.00	28.8%	38.7	0.270	2709	10.52	1388
HCRE-45-4M	A	S	NO	1.00	27.0%	36.7	0.287	2642	10.76	1356
HCRE-45-6T	A	S	NO	1.00	25.6%	37.5	0.131	2210	5.60	928
HCRE-50-4T	A	S	NO	1.00	34.4%	44.5	0.258	3886	8.37	1408
HCRE-50-4M	A	S	NO	1.00	31.9%	41.8	0.278	3810	8.54	1381
HCRE-50-6T	A	S	NO	1.00	27.9%	39.5	0.144	2416	6.12	948
HCRE-50-6M	A	S	NO	1.00	25.6%	37.0	0.157	2337	6.32	943
HCRE-56-4T	A	S	NO	1.00	30.4%	39.4	0.378	5010	8.42	1383
HCRE-56-6T	A	S	NO	1.00	29.4%	39.4	0.268	4231	6.83	925
HCRE-56-6M	A	S	NO	1.00	27.1%	36.8	0.291	4090	7.06	918
HCRE-63-4T	C	S	NO	1.00	31.8%	39.2	0.667	6835	11.39	1382
HCRE-63-6T	C	S	NO	1.00	31.2%	39.4	0.500	5853	9.77	909
HCRE-63-6M	C	S	NO	1.00	30.7%	38.9	0.507	5767	9.92	902
HCRE-71-6T	C	S	NO	1.00	35.4%	41.9	0.917	9846	12.08	925

Dimensions in mm

HRE

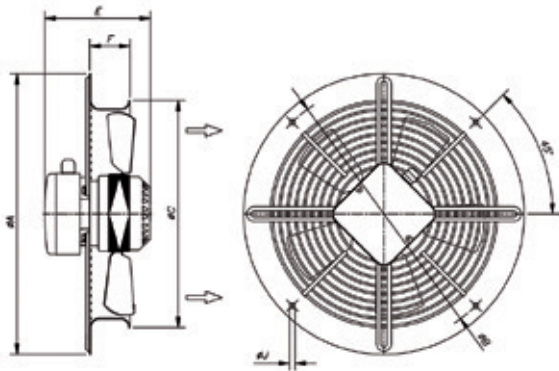

Model	ØA	ØB	ØC	E	F	ØJ
HRE-25-2T	346	320	280	135	50	7
HRE-25-2M	346	320	280	135	50	7
HRE-25-4T	346	320	280	135	50	7
HRE-25-4M	346	320	280	135	50	7
HRE-31-2T	395	360	338	146	63	10
HRE-31-2M	395	360	338	146	63	10
HRE-31-4T	395	360	338	146	63	10
HRE-31-4M	395	360	338	146	63	10
HRE-35-4T	460	420	383	175	65	10
HRE-35-4M	460	420	383	175	65	10

HCRE

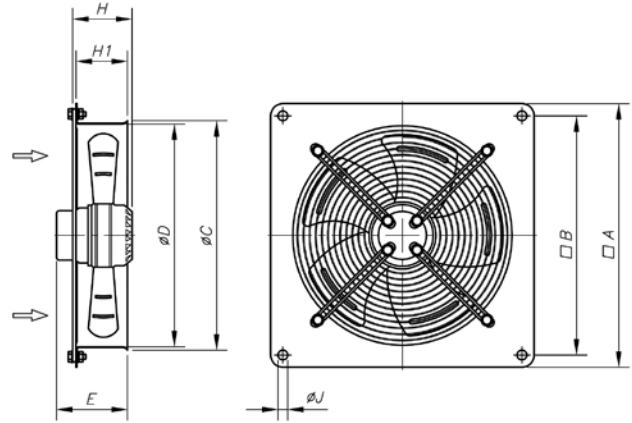

Model	A	B	ØC	ØD	E	H	H1	ØJ
HCRE-40	540	490	430	410	172	-	83	10
HCRE-45	575	520	480	460	185	-	90	10
HCRE-50	665	615	630	510	189	-	106	10
HCRE-56	725	670	570	560	203	-	106	10
HCRE-63	805	750	665	645	225	-	110	10
HCRE-71	850	810	755	725	-	235	-	10

Characteristic curves

Q = Airflow in m³/h, m³/s and cfm.

Pe = Static pressure in mmH₂O, Pa and inwg.

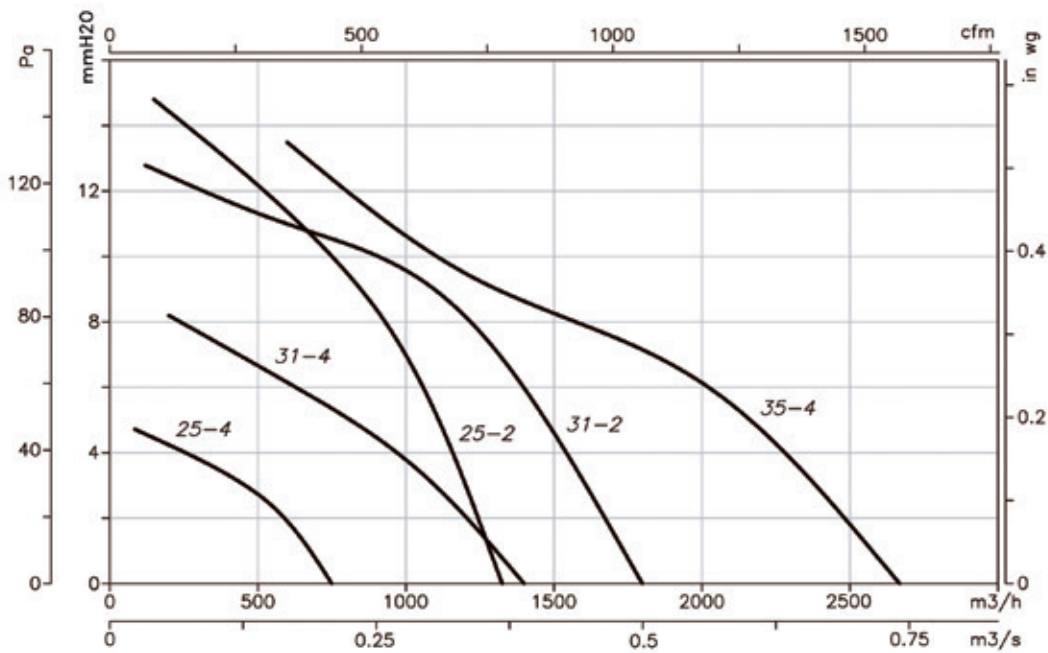

Characteristic curves

Q = Airflow in m³/h, m³/s and cfm.

Pe= Static pressure in mmH₂O, Pa and inwg.

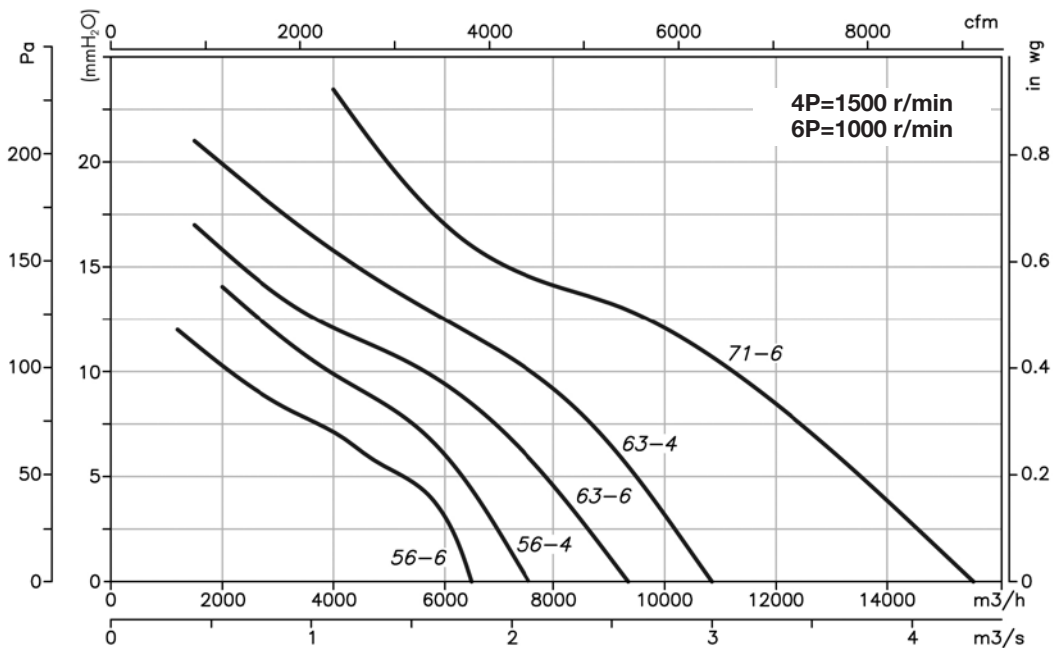
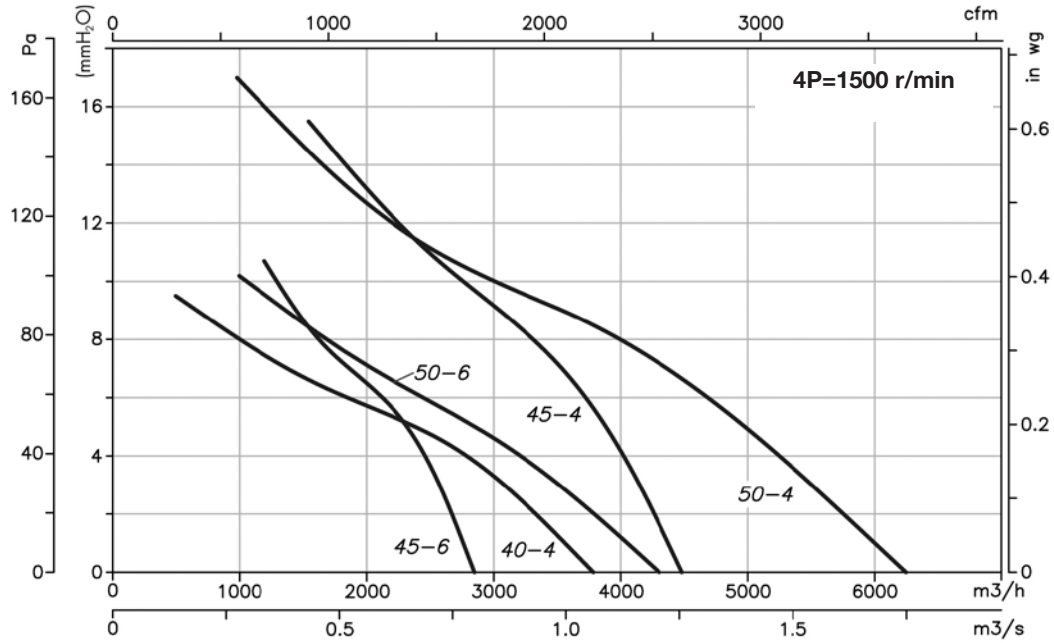

Accessories

See accessories section.





HCH HCT

Robust wall-mounted axial or long-cased fans

Robust wall-mounted axial or long-cased fans, PL version supplied with plastic impeller and AL version supplied with aluminium impeller

Fan:

- Airflow direction from motor to impeller
- PL version impellers in polyamide 6 reinforced with fibreglass and AL version in cast aluminium. HCT-40-2T and HCT-45-2T models only in AL version
- HCH: Support ring in sheet steel
- HCT: Sheet steel long casing with external terminal board

Motor:

- IE2 efficiency motors for capacities equal to or over 0.75kW and below 7.5kW, except single-phase, 2 speed and 8 pole motors.
- IE3 efficiency motors for capacities equal to or over 7.5kW, except single-phase, 2 speed and 8 pole motors.
- Class F motors, with ball bearings and IP55 protection, except single-phase versions from size 45 to size 56, IP54 protection One- or two-speed depending on the model
- Single-phase 230V-50Hz and three-phase 230/400V-50Hz (up to 4kW) and 400/690V-50Hz (power over 4kW)
- Fan working temperature: -25°C + 50°C

Finish:

- Anticorrosive finish in polyester resin polymerised at 190°C, after alkaline degreasing with phosphate-free nanotechnology treatment.

On request:

- IE2 and IE3 efficiency motors for any power.
- Airflow direction from impeller to motor.
- 100% reversible impellers.
- Special windings for different voltages.
- ATEX certification, Category 2



HCH



HCT



Order code

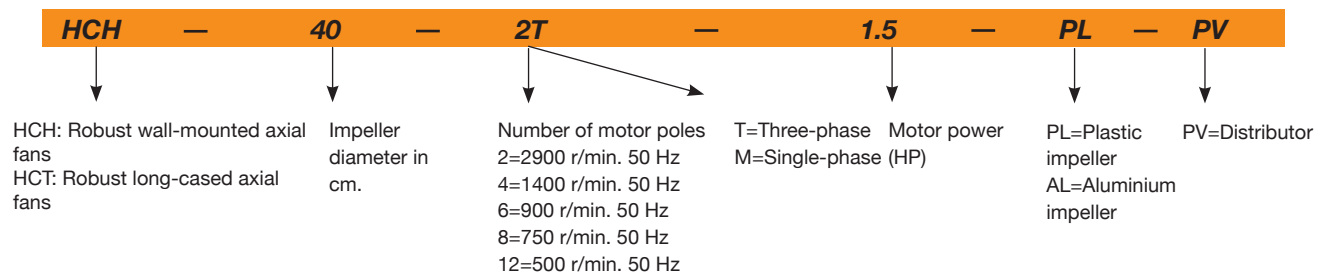

Technical characteristics

Model	Speed (r/min)	Maximum admissible current (A)			Installed capacity (kW)	Maximum airflow (m³/h)	Sound pressure level dB(A)	Approx. weight (Kg)	
		230V	400V	690V				HCH	HCT
HCT 25-2T	2670	0.64	0.37		0.09	1950	64		7
HCT 25-2M	2760	0.79			0.09	1950	64		7
HCT 25-4T	1320	0.65	0.38		0.09	1000	50		7
HCT 25-4M	1380	0.65			0.10	1000	50		7
HCT 31-2T	2750	1.21	0.70		0.18	2900	70		8
HCT 31-2M	2780	1.42			0.18	2900	70		8
HCT 31-4T	1320	0.65	0.38		0.09	1550	52		8
HCT 31-4M	1380	0.65			0.10	1550	52		8
HCH HCT 35-2T	2710	1.92	1.11		0.37	5750	77	9	12
HCT 35-2M	2780	2.53			0.37	5750	77		12
HCH HCT 35-4T	1320	0.65	0.38		0.09	3100	59	7	10
HCT 35-4M	1380	0.65			0.10	3100	59		10
HCH HCT 40-2T-1.5	2860	4.20	2.40		1.10	8800	84	17	25
HCH HCT 40-4T-0.33	1350	1.66	0.96		0.25	5150	64	13	21
HCT 45-2T-2	2770	5.44	3.13		1.50	10650	86		31
HCT 45-2T-3	2885	7.77	4.47		2.20	12750	88		34
HCT 45-2/4T-3	2910 / 1420		5.00 / 1.60		2.20 / 0.60	12750/6375	88/73		33
HCH HCT 45-4T-0.5	1370	2.02	1.17		0.37	7100	68	15	24
HCH HCT 45-4M-0.5	1400	2.76			0.37	7100	68	15	24
HCH 45-6T-0.33	900	1.51	0.87		0.25	4750	55	14	
HCH 45-6M-0.33	950	1.30			0.25	4750	55	15	

Technical characteristics

Model	Speed (r/min)	Maximum admissible current (A)			Installed capacity (kW)	Maximum airflow (m³/h)	Sound pressure level dB(A)	Approx. weight (Kg)	
		230V	400V	690V				HCH	HCT
HCT 50-4T-0.75	1380	2.92	1.69		0.55	10400	70		28
HCH HCT 56-4T-0.75	1380	2.92	1.69		0.55	11050	72	21	33
HCH HCT 56-4M-0.75	1450	4.40			0.55	11050	72	21	33
HCH HCT 56-4T-1	1410	3.10	1.79		0.75	12950	73	22	34
HCH HCT 56-4/8T-1	1430 / 710		2.00 / 0.90		0.75 / 0.20	12950/6475	73/58	23	35
HCH HCT 56-4T-1.5	1400	4.03	2.32		1.10	14000	74	26	37
HCH HCT 56-4/8T-1.5	1440 / 710		2.90 / 1.30		1.10 / 0.25	14000/7000	74/59	24	35
HCH HCT 56-4T-2	1430	5.96	3.44		1.50	15300	75	28	39
HCH HCT 56-4/8T-2	1420 / 700		3.50 / 1.50		1.50 / 0.37	15300/7650	75/60	28	39
HCH HCT 56-6T-0.33	900	1.51	0.87		0.25	8500	61	18	30
HCH HCT 56-6M-0.33	950	1.85			0.25	8400	61	19	31
HCH HCT 56-6T-0.5	900	2.24	1.30		0.37	9300	61	20	32
HCH HCT 56-6T-0.75	900	2.99	1.73		0.55	10000	62	22	34
HCH HCT 63-4T-1	1410	3.10	1.79		0.75	14150	73	27	42
HCH HCT 63-4/8T-1	1430 / 710		2.00 / 0.90		0.75 / 0.20	14150/7075	73/58	27	43
HCH HCT 63-4T-1.5	1400	4.03	2.32		1.10	17000	74	30	45
HCH HCT 63-4/8T-1.5	1440 / 710		2.90 / 1.30		1.10 / 0.25	17000/8500	74/59	29	44
HCH HCT 63-4T-2	1430	5.96	3.44		1.50	18900	75	33	48
HCH HCT 63-4/8T-2	1420 / 700		3.50 / 1.50		1.50 / 0.37	18900/9450	75/60	32	48
HCH HCT 63-4T-3	1445	8.36	4.83		2.20	22100	76	41	57
HCH HCT 63-4/8T-3	1430 / 710		4.90 / 1.70		2.20 / 0.45	22100/11050	76/61	38	54
HCH HCT 63-4T-4	1445	10.96	6.33		3.00	25400	77	43	59
HCH HCT 63-4/8T-4	1430 / 710		6.50 / 2.30		3.00 / 0.60	25400/12700	77/62	42	57
HCH HCT 63-6T-0.5	900	2.24	1.30		0.37	12150	64	25	40
HCH HCT 63-6M-0.5	900	2.69			0.37	12150	64	25	40
HCH HCT 63-6T-0.75	900	2.99	1.73		0.55	12750	65	27	42
HCH HCT 63-6T-1	945	3.90	2.20		0.75	13800	66	33	48
HCH HCT 63-6/12T-1	935 / 435		2.20 / 0.87		0.75 / 0.15	13800/6900	66/51	32	47
HCH HCT 71-4T-1.5	1400	4.03	2.32		1.10	19750	78	33	52
HCH HCT 71-4/8T-1.5	1440 / 710		2.90 / 1.30		1.10 / 0.25	19600/9800	78/63	32	51
HCH HCT 71-4T-2	1430	5.96	3.44		1.50	21100	79	36	55
HCH HCT 71-4/8T-2	1420 / 700		3.50 / 1.50		1.50 / 0.37	21100/10550	79/64	35	54
HCH HCT 71-4T-3	1445	8.36	4.83		2.20	23950	81	45	64
HCH HCT 71-4/8T-3	1430 / 710		4.90 / 1.70		2.20 / 0.45	24150/12075	81/66	42	61
HCH HCT 71-4T-4	1445	10.96	6.33		3.00	29400	82	47	66
HCH HCT 71-4/8T-4	1430 / 710		6.50 / 2.30		3.00 / 0.60	29550/14775	82/67	46	64
HCH HCT 71-6T-0.75	900	2.99	1.73		0.55	15150	67	29	49
HCH HCT 71-6M-0.75	900	3.84			0.55	15150	67	29	49
HCH HCT 71-6T-1	945	3.90	2.20		0.75	17250	68	36	55
HCH HCT 71-6/12T-1	935 / 435		2.20 / 0.87		0.75 / 0.15	17150/8575	68/53	35	54
HCH HCT 71-6T-1.5	945	4.88	2.82		1.10	20950	69	38	57
HCH HCT 71-6/12T-1.5	950 / 470		3.00 / 1.15		1.10 / 0.18	20950/10475	69/54	37	56
HCH HCT 80-4T-3	1445	8.36	4.83		2.20	28000	82	53	72
HCH HCT 80-4/8T-3	1430 / 710		4.90 / 1.70		2.20 / 0.45	28000/14000	82/67	50	69
HCH HCT 80-4T-4	1445	10.96	6.33		3.00	32700	83	55	74
HCH HCT 80-4/8T-4	1430 / 710		6.50 / 2.30		3.00 / 0.60	32700/16350	83/68	54	73
HCH HCT 80-4T-5.5	1440	14.10	8.12		4.00	37200	84	60	79
HCH HCT 80-4/8T-5.5	1430 / 710		8.20 / 2.90		4.00 / 0.80	37200/18600	84/69	66	85
HCH HCT 80-6T-1	945	3.90	2.20		0.75	20600	71	44	64
HCH HCT 80-6/12T-1	935 / 435		2.20 / 0.87		0.75 / 0.15	20600/10300	71/56	43	63
HCH HCT 80-6T-1.5	945	4.88	2.82		1.10	24250	72	46	66
HCH HCT 80-6/12T-1.5	950 / 470		3.00 / 1.15		1.10 / 0.18	24250/12125	72/57	45	65
HCH HCT 80-6T-2	955	6.42	3.71		1.50	28000	73	52	71
HCH HCT 80-6/12T-2	970 / 470		4.60 / 1.90		1.50 / 0.25	28000/14000	73/58	62	81
HCH HCT 80-6T-3	955	9.30	5.30		2.20	32500	74	57	76
HCH HCT 80-6/12T-3	940 / 470		5.60 / 2.20		2.20 / 0.37	32500/16250	74/59	62	81
HCH HCT 80-8T-0.5	700	2.77	1.60		0.37	16600	69	43	63
HCH HCT 80-8T-0.75	695	3.53	2.04		0.55	19600	70	45	65
HCH HCT 80-8T-1	705	4.68	2.70		0.75	22150	71	50	69
HCH HCT 90-4T-4	1445	10.96	6.33		3.00	37750	87	62	90
HCH HCT 90-4/8T-4	1430 / 710		6.50 / 2.30		3.00 / 0.60	37750/18875	87/72	61	88
HCH HCT 90-4T-5.5	1440	14.10	8.12		4.00	41850	89	67	95

Technical characteristics

Model	Speed (r/min)	Maximum admissible current (A)			Installed capacity (kW)	Maximum airflow (m³/h)	Sound pressure level dB(A)	Approx. weight (Kg)	
		230V	400V	690V				HCH	HCT
HCH HCT 90-4/8T-5.5	1430 / 710		8.20 / 2.90		4.00 / 0.80	41850/20925	89/74	73	101
HCH HCT 90-4T-7.5	1440		11.60	6.72	5.50	47000	91	83	109
HCH HCT 90-4/8T-7.5	1450 / 720		11.80 / 3.80		5.50 / 1.10	47000/23500	91/76	93	119
HCH HCT 90-4T-10 IE3	1465		13.90	8.06	7.50	53000	92	110	136
HCH HCT 90-4/8T-10	1460 / 725		15.30 / 5.40		7.50 / 1.50	53000/26500	92/77	98	124
HCH HCT 90-6T-2	955	6.42	3.71		1.50	30000	77	59	87
HCH HCT 90-6/12T-2	970 / 470		4.60 / 1.90		1.50 / 0.25	30000/15000	77/62	69	97
HCH HCT 90-6T-3	955	9.30	5.30		2.20	35000	78	64	92
HCH HCT 90-6/12T-3	940 / 470		5.60 / 2.20		2.20 / 0.37	35000/17500	78/63	69	97
HCH HCT 90-6T-4	960	12.70	7.30		3.00	40000	79	88	114
HCH HCT 90-6/12T-4	960 / 480		9.00 / 3.50		3.00 / 0.55	40000/20000	79/64	87	113
HCH HCT 90-8T-1	705	4.68	2.70		0.75	22400	71	57	85
HCH HCT 90-8T-1.5	705	5.63	3.25		1.10	24150	72	60	88
HCH HCT 90-8T-2	705	7.10	4.10		1.50	26300	73	71	99
HCH HCT 90-8T-3	705	9.53	5.50		2.20	30150	74	98	124
HCH HCT 100-4T-7.5	1440		11.60	6.72	5.50	52500	92	91	121
HCH HCT 100-4/8T-7.5	1450 / 720		11.80 / 3.80		5.50 / 1.10	52500/26250	92/77	101	128
HCH HCT 100-4T-10 IE3	1465		13.90	8.06	7.50	58500	93	118	147
HCH HCT 100-4/8T-10	1460 / 725		15.30 / 5.40		7.50 / 1.50	58500/29250	93/78	106	135
HCH HCT 100-4T-15 IE3	1470		20.90	12.10	11.00	68000	94	150	185
HCH HCT 100-4/8T-15	1470 / 725		23.20 / 8.70		11.00 / 2.80	68000/34000	94/79	125	160
HCH HCT 100-4T-20 IE3	1465		27.90	16.20	15.00	71850	95	161	196
HCH HCT 100-4/8T-20	1460 / 725		31.72 / 11.75		15.00 / 3.80	72450/36225	95/80	140	175
HCH HCT 100-6T-3	955	9.30	5.30		2.20	40500	82	72	103
HCH HCT 100-6/12T-3	940 / 470		5.60 / 2.20		2.20 / 0.37	40500/20250	82/67	77	108
HCH HCT 100-6T-4	960	12.70	7.30		3.00	46950	83	96	125
HCH HCT 100-6/12T-4	960 / 480		9.00 / 3.50		3.00 / 0.55	46950/23475	83/68	95	124
HCH HCT 100-6T-5.5	960	16.50	9.46		4.00	52000	84	104	133
HCH HCT 100-6/12T-5.5	970 / 480		4.00 / 11.00		4.00 / 0.65	52000/26000	84/69	100	129
HCH HCT 100-8T-1.5	705	5.63	3.25		1.10	32500	76	67	99
HCH HCT 100-8T-2	705	7.10	4.10		1.50	33850	77	79	110
HCH HCT 100-8T-3	705	9.53	5.50		2.20	35150	77	106	135
HCH HCT 100-8T-4	705	12.82	7.40		3.00	37800	78	114	143



Erp. BEP (best efficiency point) characteristics

MC	Measurement category	ηe [%]	Efficiency
EC	Efficiency category	N	Degree of efficiency
S	Static	[kW]	Electrical power
T	Total	[m³/h]	Airflow
VSD	Variable-speed drive	[mmH₂O]	Static or total pressure (According to EC)
SR	Specific relationship	[RPM]	Speed

Model	MC	EC	VSD	SR	ηe [%]	N	[kW]	[m³/h]	[mmH₂O]	[RPM]
25-2T	A	S	NO	1.00	28.6%	40.2	0.149	1196	13.07	2689
25-4M	-	-	-	-	-	-	0.102	566	3.59	1386
25-4T	-	-	-	-	-	-	0.099	586	3.45	1358
31-2T	A	S	NO	1.00	30.3%	40.5	0.242	1708	15.79	2782
31-4M	-	-	-	-	-	-	0.111	1004	4.09	1418
31-4T	-	-	-	-	-	-	0.103	1013	4.06	1397
35-2M	A	S	NO	1.00	36.5%	44.6	0.524	2983	23.52	2791
35-2T	A	S	NO	1.00	37.1%	45.2	0.515	2998	23.40	2737
35-4M	A	S	NO	1.00	28.0%	40.0	0.126	1851	6.96	1422
35-4T	-	-	-	-	-	-	0.125	1857	6.94	1375
40-2T-1.5	A	S	NO	1.00	33.9%	40.2	1.029	4386	29.24	2896
40-4T-0.33	A	S	NO	1.00	32.0%	41.7	0.289	3401	10.00	1396
45-2T-2	A	S	NO	1.00	36.9%	42.0	1.573	5401	39.47	2805
45-2T-3	A	S	NO	1.00	38.7%	43.1	2.047	8183	35.55	2910
45-2/4T-3	A	S	NO	1.00	37.7%	42.0	2.110	8454	34.61	2934
45-4T-0.5	A	S	NO	1.00	33.4%	41.8	0.475	4228	13.80	1392
45-4M-0.5	A	S	NO	1.00	32.3%	40.5	0.494	4257	13.73	1417



Erp. BEP (best efficiency point) characteristics

Model	MC	EC	VSD	SR	η_e [%]	N	[kW]	[m3/h]	[mmH ₂ O]	[RPM]
50-4T-0.75	B	T	NO	1.00	53.4%	60.6	0.733	9635	14.91	1395
56-4T-0.75	A	S	NO	1.00	33.2%	40.6	0.660	6808	11.81	1405
56-4M-0.75	A	S	NO	1.00	32.7%	40.1	0.669	6622	12.13	1422
56-4T-1	B	T	NO	1.00	66.7%	74.0	0.700	12713	13.47	1433
56-4/8T-1	B	T	NO	1.00	57.5%	64.4	0.812	12700	13.49	1448
56-4T-1.5	B	T	NO	1.00	64.4%	70.8	0.982	12951	17.91	1427
56-4/8T-1.5	B	T	NO	1.00	55.0%	60.9	1.151	12900	18.00	1456
56-6T-0.33	A	S	NO	1.00	31.4%	41.7	0.237	3564	7.69	919
63-4T-1	C	S	NO	1.00	45.0%	52.0	0.794	8989	14.61	1424
63-4/8T-1	C	S	NO	1.00	38.2%	44.7	0.938	8924	14.74	1440
63-4T-1.5	C	S	NO	1.00	45.3%	51.1	1.179	10593	18.50	1412
63-4/8T-1.5	C	S	NO	1.00	41.4%	47.1	1.286	10448	18.74	1451
63-4T-2	C	S	NO	1.00	44.6%	49.8	1.493	11688	20.93	1442
63-4/8T-2	C	S	NO	1.00	38.4%	43.2	1.734	11566	21.13	1433
63-4T-3	B	T	NO	1.00	70.7%	75.1	2.040	20222	26.19	1457
63-4/8T-3	B	T	NO	1.00	63.2%	67.2	2.285	20235	26.17	1445
63-4T-4	B	T	NO	1.00	65.4%	68.4	3.388	23305	34.90	1447
63-4/8T-4	B	T	NO	1.00	59.3%	62.1	3.735	23310	34.89	1432
63-6T-0.5	C	S	NO	1.00	32.7%	41.1	0.474	6417	8.88	921
63-6M-0.5	C	S	NO	1.00	32.2%	40.6	0.482	6339	8.99	915
63-6T-0.75	C	S	NO	1.00	32.6%	40.6	0.547	6936	9.46	933
71-4T-1.5	C	S	NO	1.00	53.4%	59.2	1.217	11355	21.04	1409
71-4/8T-1.5	C	S	NO	1.00	45.1%	50.4	1.411	11393	20.50	1446
71-4T-2	C	S	NO	1.00	50.1%	55.3	1.508	13256	20.95	1442
71-4/8T-2	C	S	NO	1.00	43.7%	48.5	1.731	13141	21.15	1433
71-4T-3	C	S	NO	1.00	45.6%	49.8	2.216	14513	25.59	1453
71-4/8T-3	C	S	NO	1.00	41.7%	45.6	2.478	14275	26.60	1441
71-4T-4	C	S	NO	1.00	38.4%	41.3	3.404	18556	25.85	1447
71-4/8T-4	C	S	NO	1.00	37.5%	40.4	3.534	18165	26.80	1436
71-6T-0.75	C	S	NO	1.00	35.7%	43.0	0.710	8036	11.60	913
71-6M-0.75	C	S	NO	1.00	33.6%	40.7	0.755	7945	11.73	908
71-6T-1	C	S	NO	1.00	35.3%	42.3	0.796	8550	12.07	956
71-6/12T-1	C	S	NO	1.00	33.6%	40.5	0.829	8626	11.87	952
71-6T-1.5	C	S	NO	1.00	37.6%	43.6	1.123	12806	12.11	956
71-6/12T-1.5	C	S	NO	1.00	34.3%	40.1	1.231	12800	12.12	1063
80-4T-3	C	S	NO	1.00	56.7%	60.7	2.309	16178	29.73	1451
80-4/8T-3	C	S	NO	1.00	50.1%	53.8	2.621	15754	30.61	1437
80-4T-4	C	S	NO	1.00	54.0%	57.1	3.246	19442	33.11	1449
80-4/8T-4	C	S	NO	1.00	50.1%	53.0	3.496	19059	33.78	1437
80-4T-5.5	C	S	NO	1.00	51.4%	53.8	4.207	20980	37.85	1445
80-4/8T-5.5	C	S	NO	1.00	50.0%	52.3	4.324	20666	38.41	1437
80-6T-1	C	S	NO	1.00	48.0%	54.5	0.939	12168	13.62	948
80-6/12T-1	C	S	NO	1.00	43.1%	49.3	1.043	12343	13.38	939
80-6T-1.5	C	S	NO	1.00	46.7%	52.1	1.380	15312	15.45	946
80-6/12T-1.5	C	S	NO	1.00	43.1%	48.4	1.492	15127	15.63	952
80-6T-2	C	S	NO	1.00	42.2%	46.8	1.845	17013	16.79	956
80-6/12T-2	C	S	NO	1.00	39.2%	43.7	1.979	16702	17.06	971
80-6T-3	B	T	NO	1.00	69.0%	72.7	2.607	30267	21.81	956
80-6/12T-3	B	T	NO	1.00	62.2%	65.7	2.890	30286	21.80	942
80-8T-0.5	C	S	NO	1.00	36.0%	43.8	0.584	10464	7.37	701
80-8T-0.75	C	S	NO	1.00	33.9%	40.7	0.830	12481	8.28	696
80-8T-1	C	S	NO	1.00	35.4%	41.6	1.070	14234	9.79	707
90-4T-4	C	S	NO	1.00	58.1%	61.1	3.362	20308	35.36	1447
90-4/8T-4	C	S	NO	1.00	53.2%	55.9	3.681	20152	35.69	1433
90-4T-5.5	C	S	NO	1.00	56.2%	58.5	4.306	24635	36.06	1444
90-4/8T-5.5	C	S	NO	1.00	53.9%	56.1	4.487	24524	36.24	1435
90-4T-7.5	C	S	NO	1.01	53.2%	54.6	6.004	26945	43.56	1442
90-4/8T-7.5	C	S	NO	1.01	47.6%	48.7	6.705	26824	43.74	1452
90-4T-10 IE3	C	S	NO	1.01	51.3%	52.0	7.716	33102	43.89	1467
90-4/8T-10	C	S	NO	1.01	46.3%	46.7	8.546	32957	44.09	1463
90-6T-2	C	S	NO	1.00	50.9%	55.7	1.777	18106	18.37	957
90-6/12T-2	C	S	NO	1.00	46.5%	51.0	1.944	18044	18.42	971
90-6T-3	C	S	NO	1.00	43.0%	46.8	2.492	22079	17.82	958
90-6/12T-3	C	S	NO	1.00	38.8%	42.4	2.760	21982	17.90	945
90-6T-4	B	T	NO	1.00	69.6%	72.7	3.270	37620	22.19	963
90-6/12T-4	B	T	NO	1.00	60.5%	63.2	3.762	37632	22.18	963
90-8T-1	C	S	NO	1.00	42.4%	48.8	0.980	13430	11.36	715
90-8T-1.5	C	S	NO	1.00	34.9%	40.5	1.332	14032	12.18	710



Erp. BEP (best efficiency point) characteristics

Model	MC	EC	VSD	SR	η [%]	N	[kW]	[m3/h]	[mmH ₂ O]	[RPM]
90-8T-2	C	S	NO	1.00	37.3%	42.8	1.375	14674	12.84	719
90-8T-3	C	S	NO	1.00	36.6%	41.5	1.675	16898	13.32	724
100-4T-7.5	C	S	NO	1.00	51.0%	52.4	5.965	27281	40.95	1443
100-4/8T-7.5	C	S	NO	1.00	45.7%	46.8	6.658	27102	41.24	1452
100-4T-10 IE3	C	S	NO	1.00	48.4%	49.1	7.832	36164	38.48	1467
100-4/8T-10	C	S	NO	1.00	43.0%	43.3	8.817	35646	39.03	1465
100-4T-15 IE3	C	S	NO	1.01	48.5%	48.5	11.339	44388	45.52	1472
100-4/8T-15	C	S	NO	1.01	43.0%	42.9	12.785	44106	45.84	1471
100-4T-20 IE3	C	S	NO	1.01	45.2%	45.1	13.169	46050	47.49	1472
100-4/8T-20	C	S	NO	1.01	41.5%	41.2	14.690	43763	51.13	1467
100-6T-3	C	S	NO	1.00	47.3%	51.1	2.461	23849	17.92	959
100-6/12T-3	C	S	NO	1.00	41.7%	45.3	2.789	23616	18.11	944
100-6T-4	C	S	NO	1.00	43.5%	46.3	3.541	28826	19.61	960
100-6/12T-4	C	S	NO	1.00	38.7%	41.2	3.980	28654	19.74	961
100-6T-5.5	C	S	NO	1.00	41.7%	43.8	4.637	32856	21.61	965
100-6/12T-5.5	C	S	NO	1.00	39.1%	41.1	4.939	32699	21.71	971
100-8T-1.5	C	S	NO	1.00	47.6%	52.9	1.452	19345	13.11	707
100-8T-2	C	S	NO	1.00	42.7%	47.2	1.923	20901	14.42	706

Acoustic features

The specified values are determined according to free field measurements of pressure and sound levels in dB(A) at an equivalent distance of twice the fan's span plus the impeller's diameter, with a minimum of 1.5 m.

Sound power Lw(A) spectrum in dB(A) via frequency band in Hz.

Model	63	125	250	500	1000	2000	4000	8000	Model	63	125	250	500	1000	2000	4000	8000
25-2	35	50	69	68	69	68	63	54	80-8-3 (2v)	44	64	72	77	79	76	69	58
25-4	21	36	55	54	55	54	49	40	80-4-4	60	80	88	93	95	92	85	74
31-2	41	56	75	74	75	74	69	60	80-8-4 (2v)	45	65	73	78	80	77	70	59
31-4	23	38	57	56	57	56	51	42	80-4-5.5	61	81	89	94	96	93	86	75
35-2	48	63	82	81	82	81	76	67	80-8-5.5 (2v)	46	66	74	79	81	78	71	60
35-4	30	45	64	63	64	63	58	49	80-6-1	48	68	76	81	83	80	73	62
40-2	55	70	89	88	89	88	83	74	80-12-1 (2v)	33	53	61	66	68	65	58	47
40-4	35	50	69	68	69	68	63	54	80-6-1.5	49	69	77	82	84	81	74	63
45-2-2	51	68	80	88	93	93	89	82	80-12-1.5 (2v)	34	54	62	67	69	66	59	48
45-2-3	53	70	82	90	95	95	91	84	80-6-2	50	70	78	83	85	82	75	64
45-4-3 (2v)	38	55	67	75	80	80	76	69	80-12-2 (2v)	35	55	63	68	70	67	60	49
45-4-0.5	33	50	62	70	75	75	71	64	80-6-3	51	71	79	84	86	83	76	65
45-6	20	37	49	57	62	62	58	51	80-12-3 (2v)	36	56	64	69	71	68	61	50
50-4	37	54	67	74	79	80	75	68	80-8-0.5	46	66	74	79	81	78	71	60
56-4-0.75	47	67	75	80	82	79	72	61	80-8-0.75	47	67	75	80	82	79	72	61
56-4-1	48	68	76	81	83	80	73	62	80-8-1	48	68	76	81	83	80	73	62
56-8-1 (2v)	33	53	61	66	68	65	58	47	90-4-4	65	86	93	98	101	97	90	79
56-4-1.5	49	69	77	82	84	81	74	63	90-8-4 (2v)	50	71	78	83	86	82	75	64
56-8-1.5 (2v)	34	54	62	67	69	66	59	48	90-4-5.5	67	88	95	100	103	99	92	81
56-4-2	50	70	78	83	85	82	75	64	90-8-5.5 (2v)	52	73	80	85	88	84	77	66
56-8-2 (2v)	35	55	63	68	70	67	60	49	90-4-7.5	69	90	97	102	105	101	94	83
56-6-0.33	36	56	64	69	71	68	61	50	90-8-7.5 (2v)	54	75	82	87	90	86	79	68
56-6-0.5	36	56	64	69	71	68	61	50	90-4-10	70	91	98	103	106	102	95	84
56-6-0.75	37	57	65	70	72	69	62	51	90-8-10 (2v)	55	76	83	88	91	87	80	69
63-4-1	50	70	78	83	85	82	75	64	90-6-2	55	76	83	88	91	87	80	69
63-8-1 (2v)	35	55	63	68	70	67	60	49	90-12-2 (2v)	40	61	68	73	76	72	65	54
63-4-1.5	51	71	79	84	86	83	76	65	90-6-3	56	77	84	89	92	88	81	70
63-8-1.5 (2v)	36	56	64	69	71	68	61	50	90-12-3 (2v)	41	62	69	74	77	73	66	55
63-4-2	52	72	80	85	87	84	77	66	90-6-4	57	78	85	90	93	89	82	71
63-8-2 (2v)	37	57	65	70	72	69	62	51	90-12-4 (2v)	42	63	70	75	78	74	67	56
63-4-3	53	73	81	86	88	85	78	67	90-8-1	49	70	77	82	85	81	74	63
63-8-3 (2v)	38	58	66	71	73	70	63	52	90-8-1.5	50	71	78	83	86	82	75	64
63-4-4	54	74	82	87	89	86	79	68	90-8-2	51	72	79	84	87	83	76	65
63-8-4 (2v)	39	59	67	72	74	71	64	53	90-8-3	52	73	80	85	88	84	77	66
63-6-0.5	41	61	69	74	76	73	66	55	100-4-7.5	72	92	100	105	107	104	97	86
63-6-0.75	42	62	70	75	77	74	67	56	100-8-7.5 (2v)	57	77	85	90	92	89	82	71
63-6-1	43	63	71	76	78	75	68	57	100-4-10	73	93	101	106	108	105	98	87
63-12-1 (2v)	28	48	56	61	63	60	53	42	100-8-10 (2v)	58	78	86	91	93	90	83	72
71-4-1.5	55	75	83	88	90	87	80	69	100-4-15	74	94	102	107	109	106	99	88
71-8-1.5 (2v)	40	60	68	73	75	72	65	54	100-8-15 (2v)	59	79	87	92	94	91	84	73
71-4-2	56	76	84	89	91	88	81	70	100-4-20	75	95	103	108	110	107	100	89
71-8-2 (2v)	41	61	69	74	76	73	66	55	100-8-20 (2v)	60	80	88	93	95	92	85	74
71-4-3	58	78	86	91	93	90	83	72	100-6-3	62	82	90	95	97	94	87	76
71-8-3 (2v)	43	63	71	76	78	75	68	57	100-12-3 (2v)	47	67	75	80	82	79	72	61
71-4-4	59	79	87	92	94	91	84	73	100-6-4	63	83	91	96	98	95	88	77
71-8-4 (2v)	44	64	72	77	79	76	69	58	100-12-4 (2v)	48	68	76	81	83	80	73	62
71-6-0.75	44	64	72	77	79	76	69	58	100-6-5.5	64	84	92	97	99	96	89	78
71-6-1	45	65	73	78	80	77	70	59	100-12-5.5 (2v)	49	69	77	82	84	81	74	63
71-12-1 (2v)	30	50	58	63	65	62	55	44	100-8-1.5	56	76	84	89	91	88	81	70
71-6-1.5	46	66	74	79	81	78	71	60	100-8-2	57	77	85	90	92	89	82	71
71-12-1.5 (2v)	31	51	59	64	66	63	56	45	100-8-3	57	77	85	90	92	89	82	71
80-4-3	59	79	87	92	94	91	84	73	100-8-4	58	78	86	91	93	90	83	72

Dimensions in mm

HCH

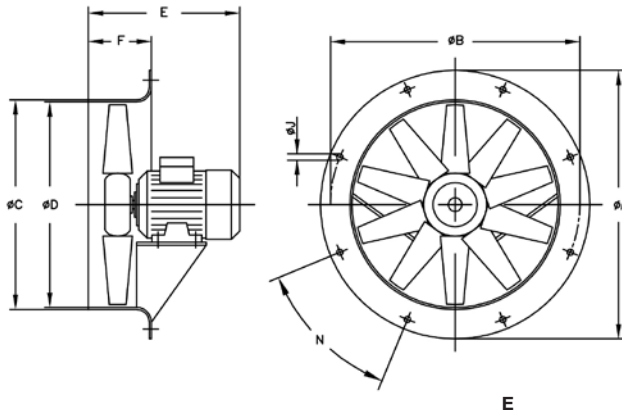

Model	ØA	ØB	ØC	ØD	0.16	0.33	0.5	0.75	1	1.5	2	3	4	5.5	7.5	10	15	20	F	ØJ	N
HCH-35-2	425	395	358	355	-	-	285	-	-	-	-	-	-	-	-	-	-	-	110	10	8 X 45°
HCH-35-4	425	395	358	355	257	-	-	-	-	-	-	-	-	-	-	-	-	-	110	10	8 X 45°
HCH-40-2	490	450	414	410	-	-	-	-	-	314	-	-	-	-	-	-	-	-	120	12	8 X 45°
HCH-40-4	490	450	414	410	-	305	-	-	-	-	-	-	-	-	-	-	-	-	120	12	8 X 45°
HCH-45-4	540	500	464	460	-	-	295	-	-	-	-	-	-	-	-	-	-	-	120	12	8 X 45°
HCH-45-6	540	500	464	460	-	295	-	-	-	-	-	-	-	-	-	-	-	-	120	12	8 X 45°
HCH-56-4	660	620	564	560	-	-	-	316	316	330	354	-	-	-	-	-	-	-	120	12	12 X 30°
HCH-56-6	660	620	564	560	-	298	316	316	-	-	-	-	-	-	-	-	-	-	120	12	12 X 30°
HCH-63-4	730	690	645	640	-	-	-	-	332	340	366	420	420	-	-	-	-	-	150	12	12 X 30°
HCH-63-6	730	690	645	640	-	-	332	332	340	-	-	-	-	-	-	-	-	-	150	12	12 X 30°
HCH-71-4	810	770	715	710	-	-	-	-	-	334	360	430	430	-	-	-	-	-	150	12	16 X 22°30'
HCH-71-6	810	770	715	710	-	-	-	323	334	360	-	-	-	-	-	-	-	-	150	12	16 X 22°30'
HCH-80-4	900	860	805	800	-	-	-	-	-	-	-	425	425	445	-	-	-	-	180	12	16 X 22°30'
HCH-80-6	900	860	805	800	-	-	-	-	360	386	425	445	-	-	-	-	-	-	180	12	16 X 22°30'
HCH-80-8	900	860	805	800	-	-	380	386	410	-	-	-	-	-	-	-	-	-	180	12	16 X 22°30'
HCH-90-4	1015	970	906	900	-	-	-	-	-	-	-	-	436	430	465	465	-	-	180	12	16 X 22°30'
HCH-90-6	1015	970	906	900	-	-	-	-	-	-	436	430	465	-	-	-	-	-	180	12	16 X 22°30'
HCH-90-8	1015	970	906	900	-	-	-	-	436	436	430	460	-	-	-	-	-	-	180	12	16 X 22°30'
HCH-100-4	1115	1070	1006	1000	-	-	-	-	-	-	-	-	-	-	480	503	612	612	200	15	16 X 22°30'
HCH-100-6	1115	1070	1006	1000	-	-	-	-	-	-	440	503	503	-	-	-	-	-	200	15	16 X 22°30'
HCH-100-8	1115	1070	1006	1000	-	-	-	-	-	433	405	470	470	-	-	-	-	-	200	15	16 X 22°30'

HCT

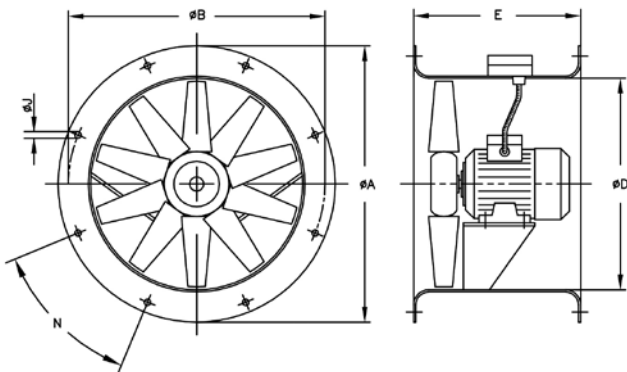

Model	ØA	ØB	ØD	E	E1	ØJ	N
HCT-25	310	280	240	230	10	10	4x90°
HCT-31	350	320	280	270	-	10	4x90°
HCT-35	425	395	355	280	-	10	8x45°
HCT-40	490	450	410	320	-	12	8x45°
HCT-45	540	500	460	360	-	12	8x45°
HCT-50	600	560	514	360	-	12	12x30°
HCT-56	660	620	560	400	-	12	12x30°
HCT-63	730	690	640	430	-	12	12x30°
HCT-71	810	770	710	500	-	12	16x22°30'
HCT-80	900	860	800	500	-	12	16x22°30'
HCT-90	1015	970	900	500	-	15	16x22°30'
HCT-100	1115	1070	1000	600	-	15	16x22°30'
HCT-100-4T-15	1115	1070	1000	700	-	15	16x22°30'
HCT-100-4T-20	1115	1070	1000	700	-	15	16x22°30'

Characteristic curves

Q = Airflow in m³/h, m³/s and cfm.

Pe = Static pressure in mmH₂O, Pa and inwg.

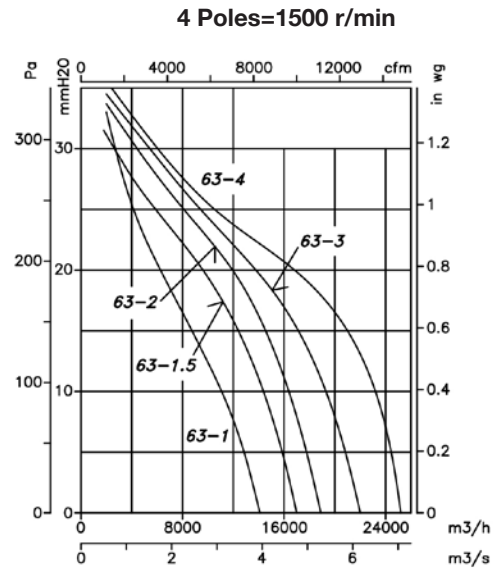
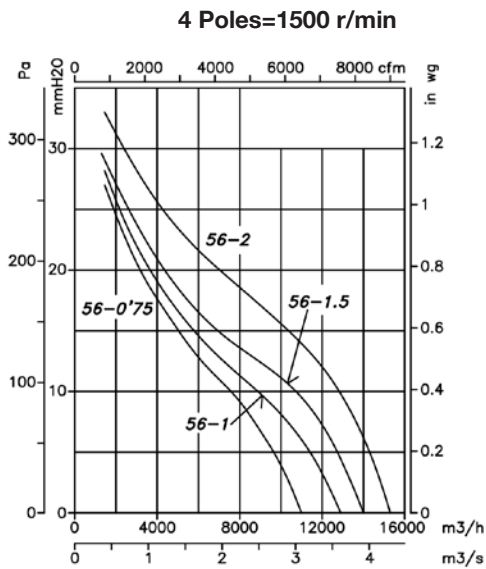
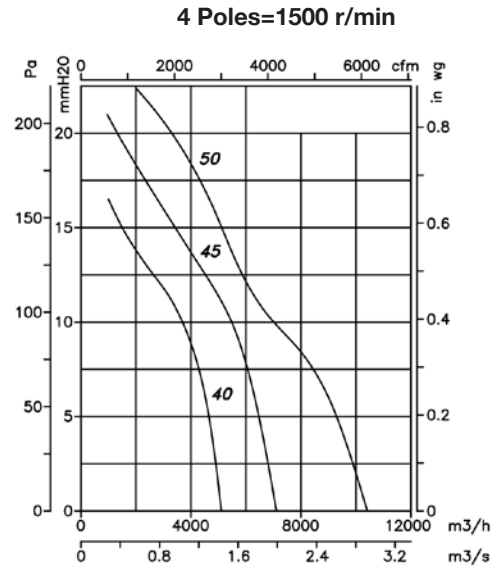
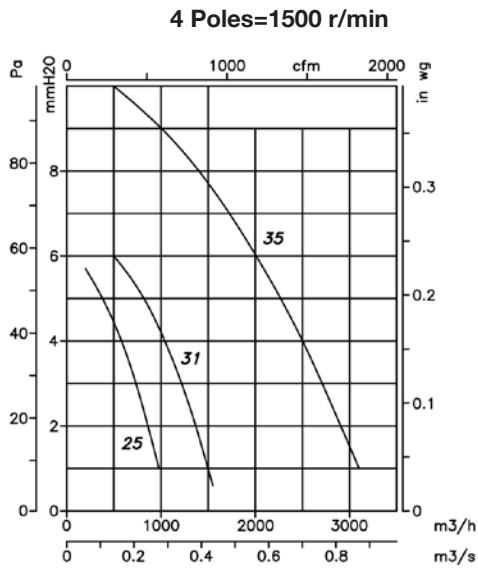
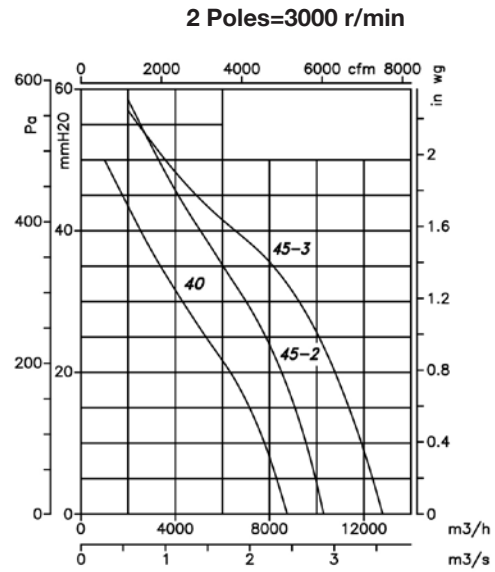
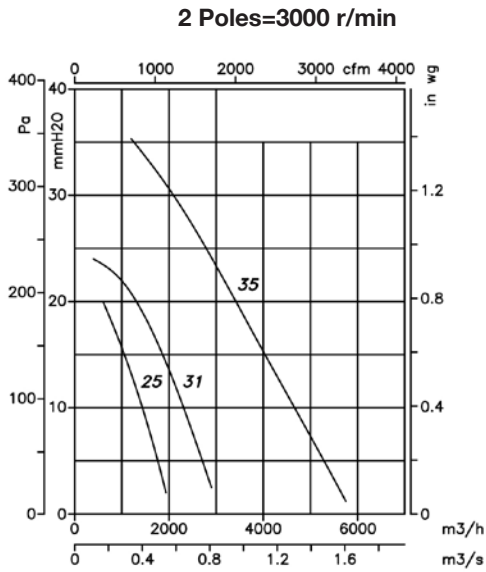

Characteristic curves

Q = Airflow in m³/h, m³/s and cfm.

Pe= Static pressure in mmH₂O, Pa and inwg.

4 Poles=1500 r/min

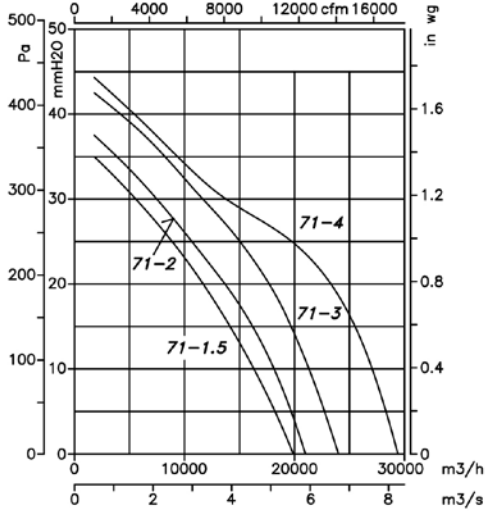

4 Poles=1500 r/min

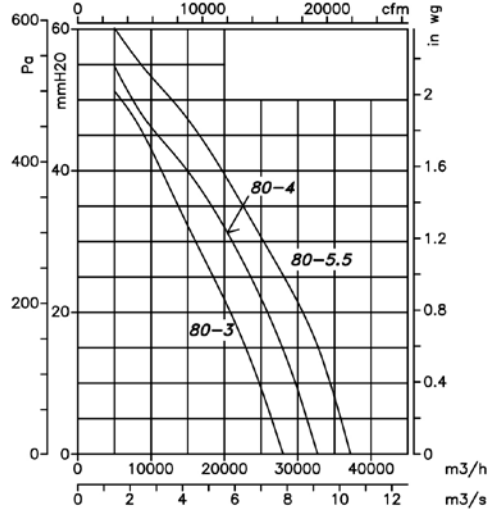

4 Poles=1500 r/min

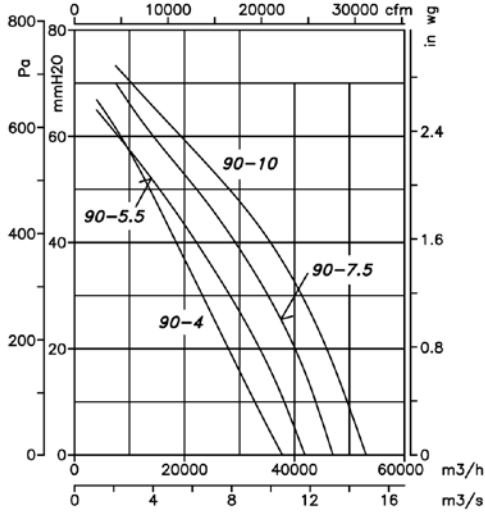

4 Poles=1500 r/min

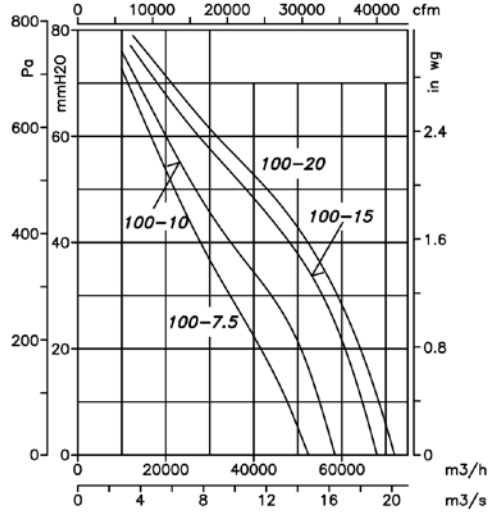

6 Poles=1000 r/min

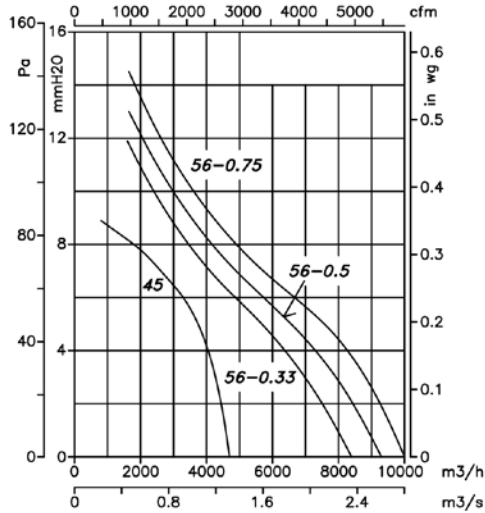

6 Poles=1000 r/min

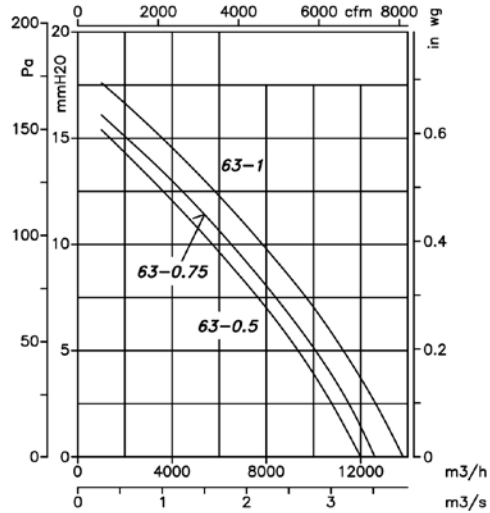

Characteristic curves

Q = Airflow in m³/h, m³/s and cfm.

Pe= Static pressure in mmH₂O, Pa and inwg.

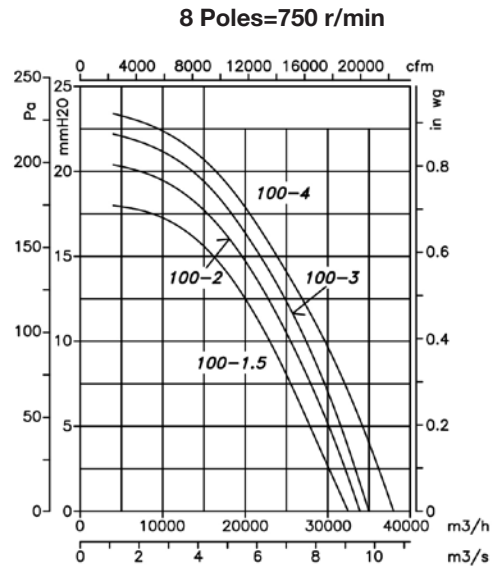
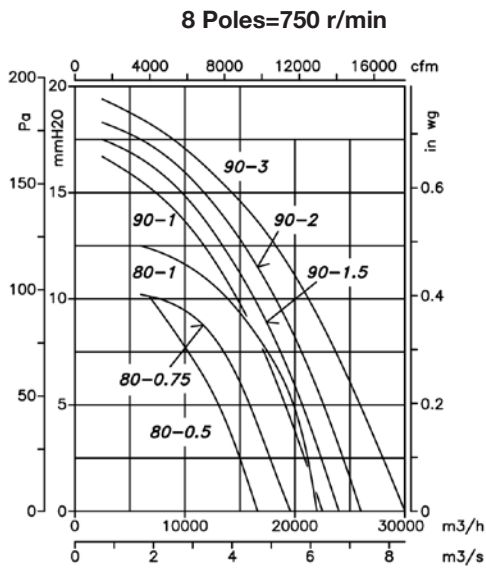
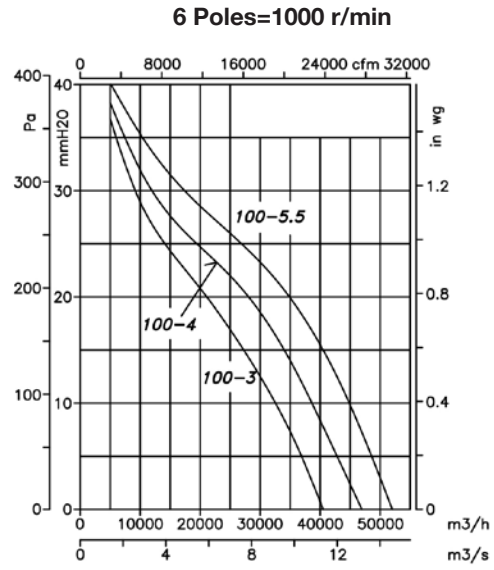
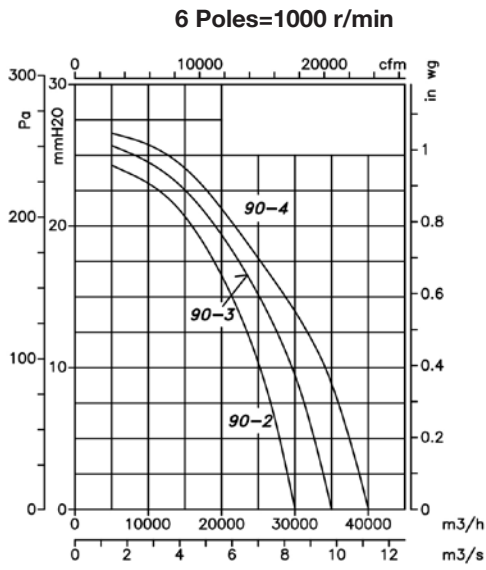
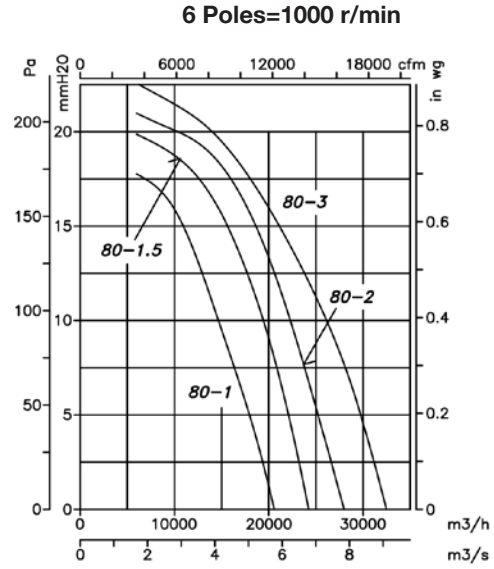
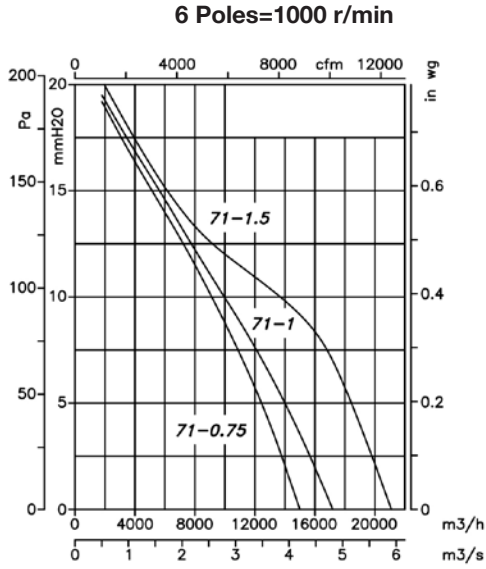

Characteristic curves

Q = Airflow in m³/h, m³/s and cfm.

Pe = Static pressure in mmH₂O, Pa and inwg.

4 Poles (2-speed motor)=2/4 Poles

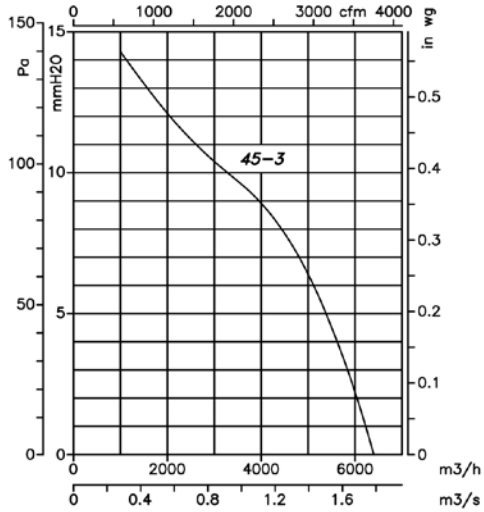

8 Poles (2-speed motor)=4/8 Poles

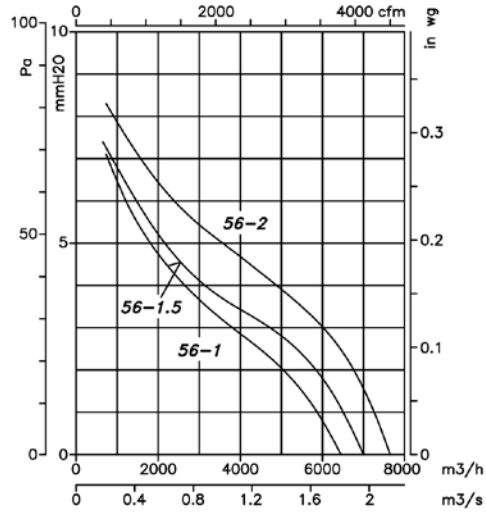

8 Poles (2-speed motor) =4/8 Poles

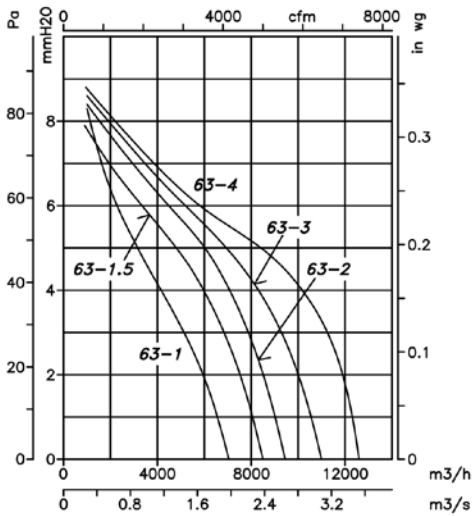

8 Poles (2-speed motor)=4/8 Poles

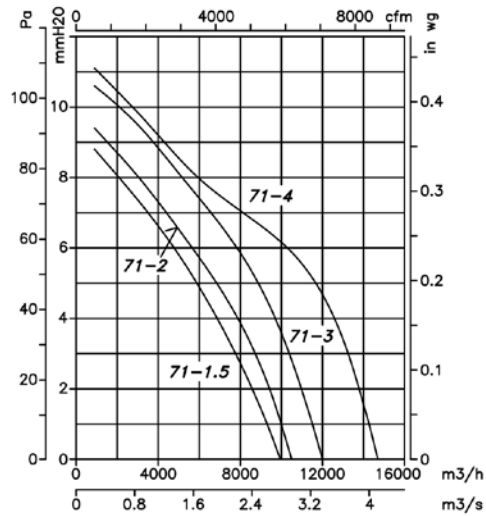

8 Poles (2-speed motor)=4/8 Poles

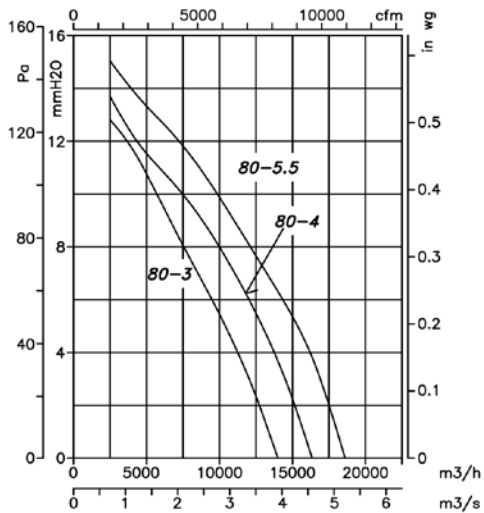

8 Poles (2-speed motor)=4/8 Poles

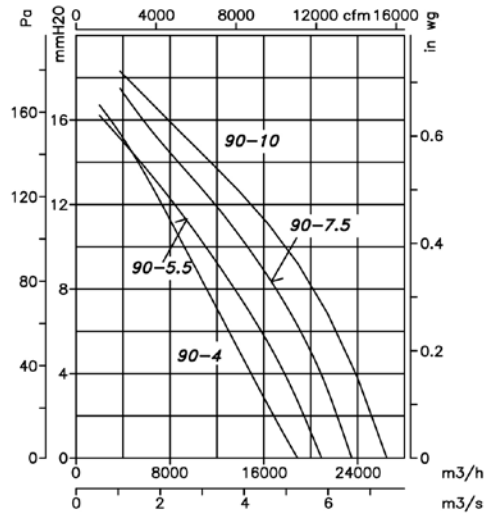

Characteristic curves

Q = Airflow in m³/h, m³/s and cfm.

Pe = Static pressure in mmH₂O, Pa and inwg.

8 Poles (2-speed motor) =4/8 Poles

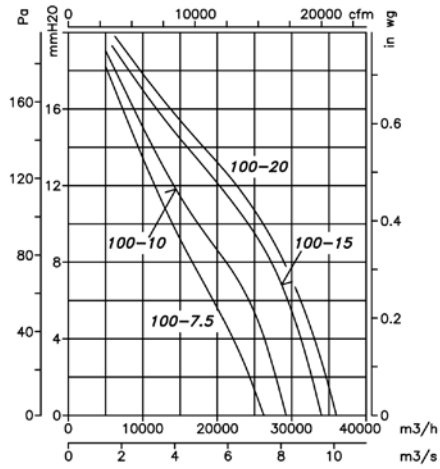

12 Poles (2-speed motor)=6/12 Poles

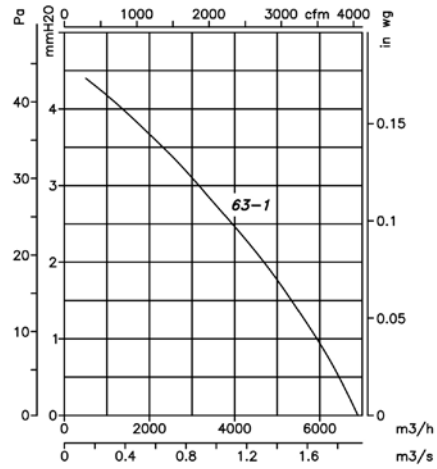

12 Poles (2-speed motor)=6/12 Poles

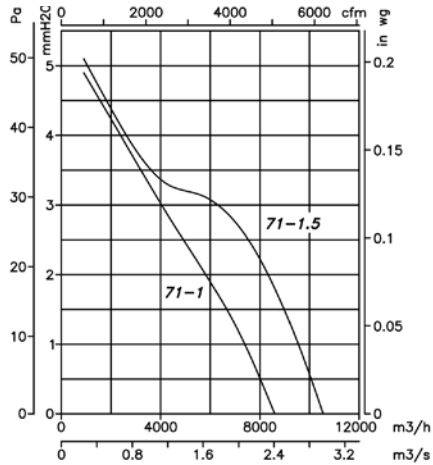

12 Poles (2-speed motor)=6/12 Poles

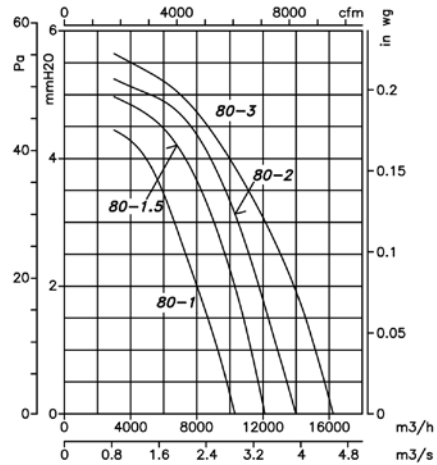

12 Poles (2-speed motor)=6/12 Poles

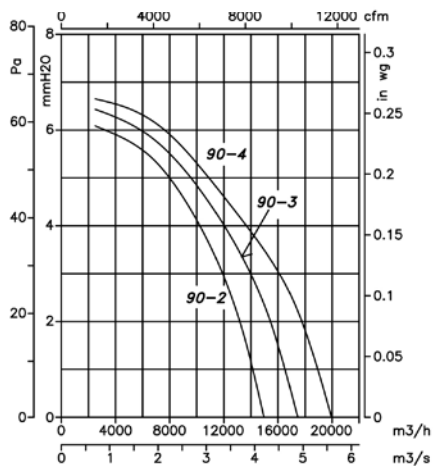

12 Poles (2-speed motor)=6/12 Poles

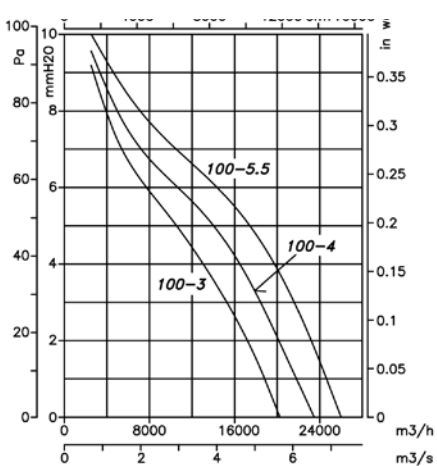

Accessories

See accessories section.



HFW

Hot galvanised cased fans

Cased axial fans designed with four support arms to reduce vibrations, and fitted with low energy consumption aerodynamic aluminium blade



Fan:

- Airflow direction from motor to blade.
- AL version blades in cast aluminium
- Support ring in sheet steel with double clamp and cable duct for motor power supply.
- Hot galvanised sheet steel long casing.

- Three-phase 230/400V-50Hz. (up to 4kW) and 400/690V-50Hz. (power over 4kW)
- Fan working temperature: -25°C +50°C.

Finish:

- Hot galvanised steel

Motor:

- IE2 efficiency motors for capacities equal to or over 0.75kW and below 7.5kW, except single-phase, 2 speed and 8 pole motors.
- IE3 efficiency motors for capacities equal to or over 7.5kW, except single-phase, 2 speed and 8 pole motors
- Class F motors, with ball bearings, IP55 protection

On request:

- Airflow direction from impeller to motor.
- PL version impellers in polyamide with fibreglass.
- 100% reversible impellers.
- Special windings for different voltages.
- ATEX certification, Category 2.
- IE2 and IE3 efficiency motors for any power

Order code

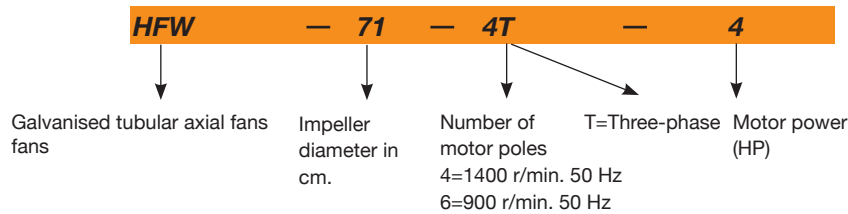

Technical Characteristics

Model	Speed (r/min)	Maximum admissible current (A)			Installed capacity (kW)	Impeller blade angle (°)	Maximum airflow (m³/h)	Sound pressure level dB(A)	Approx. weight (Kg)
		230V	400V	690V					
HFW-56-4T-1	1410	3.10	1.79		0.75	22	11250	73	28
HFW-56-4T-1.5	1400	4.03	2.32		1.10	30	13600	74	32
HFW-56-4T-2	1430	5.96	3.44		1.50	36	15050	75	30
HFW-56-6T-0.75	910	2.59	1.49		0.55	38	10150	62	23
HFW-63-4T-1	1410	3.10	1.79		0.75	14	15200	73	29
HFW-63-4T-1.5	1400	4.03	2.32		1.10	20	17800	74	32
HFW-63-4T-2	1430	5.96	3.44		1.50	24	19300	75	35
HFW-63-4T-3	1445	8.36	4.83		2.20	32	22150	76	43
HFW-63-4T-4	1445	10.96	6.33		3.00	38	24250	77	45
HFW-63-6T-0.75	910	2.59	1.49		0.55	28	13600	65	29
HFW-63-6T-1	945	3.90	2.20		0.75	38	15900	66	35
HFW-71-4T-1.5	1400	4.03	2.32		1.10	12	19500	78	35
HFW-71-4T-2	1430	5.96	3.44		1.50	14	20900	79	38
HFW-71-4T-3	1445	8.36	4.83		2.20	22	25100	81	47
HFW-71-4T-4	1445	10.96	6.33		3.00	28	27500	82	49
HFW-71-6T-0.75	910	2.59	1.49		0.55	20	16100	67	31
HFW-71-6T-1	945	3.90	2.20		0.75	26	17300	68	38
HFW-71-6T-1.5	945	4.88	2.82		1.10	34	19950	69	40
HFW-80-4T-3	1445	8.36	4.83		2.20	12	25450	82	55
HFW-80-4T-4	1445	10.96	6.33		3.00	16	30250	83	57
HFW-80-4T-5.5	1440	14.10	8.12		4.00	18	32750	84	62
HFW-80-6T-1.5	945	4.88	2.82		1.10	18	21450	72	48
HFW-80-6T-2	955	6.42	3.71		1.50	26	25950	73	54
HFW-80-6T-3	955	9.30	5.30		2.20	32	29950	74	59
HFW-90-4T-4	1445	10.96	6.33		3.00	8	33600	87	66
HFW-90-4T-5.5	1440	14.10	8.12		4.00	12	38900	89	71
HFW-90-4T-7.5	1440		10.60	6.14	5.50	18	46150	91	87
HFW-90-4T-10 IE3	1465		8.06	13.90	7.50	22	50150	92	98
HFW-90-6T-2	955	6.42	3.71		1.50	16	28800	77	63
HFW-90-6T-3	955	9.30	5.30		2.20	24	34000	78	68
HFW-90-6T-4	960	12.70	7.30		3.00	30	38900	79	92
HFW-100-4T-7.5	1440		10.60	6.14	5.50	10	46850	92	95
HFW-100-4T-10 IE3	1465		8.06	13.90	7.50	16	57400	93	106
HFW-100-4T-15 IE3	1470		20.90	12.10	11.00	22	66300	94	129
HFW-100-4T-20 IE3	1470		28.30	16.40	15.00	28	76150	95	148
HFW-100-6T-3	955	9.30	5.30		2.20	16	37600	82	76
HFW-100-6T-4	960	12.70	7.30		3.00	20	41150	83	100
HFW-100-6T-5.5	960	16.50	9.46		4.00	26	47800	84	108

Acoustic Features

The specified values are determined according to free field measurements of pressure and sound levels in dB(A) at an equivalent distance of twice the fan's external diameter plus the impeller's diameter, with a minimum of 1.5 m.

Sound power Lw(A) spectrum in dB(A) via frequency band in Hz.

Model	63	125	250	500	1000	2000	4000	8000	Model	63	125	250	500	1000	2000	4000	8000
HFW-56-4T-1	48	68	76	81	83	80	73	62	HFW-80-4T-4	56	76	84	89	91	88	81	74
HFW-56-4T-1.5	49	69	77	82	84	81	74	63	HFW-80-4T-5.5	56	76	84	89	91	88	81	70
HFW-56-4T-2	50	70	78	83	85	82	75	64	HFW-80-6T-1.5	49	66	74	79	81	78	71	60
HFW-56-6T-0.75	37	57	65	70	72	69	62	51	HFW-80-6T-2	50	67	75	80	82	79	72	61
HFW-63-4T-1	50	70	78	83	85	82	75	64	HFW-80-6T-3	51	68	76	81	83	80	73	62
HFW-63-4T-1.5	48	68	76	81	83	80	73	65	HFW-90-4T-4	61	82	89	94	97	93	86	79
HFW-63-4T-2	52	68	76	81	83	80	73	66	HFW-90-4T-5.5	60	81	88	93	96	92	85	74
HFW-63-4T-3	53	70	78	83	85	82	77	67	HFW-90-4T-7.5	59	80	87	92	95	91	84	73
HFW-63-4T-4	54	71	79	84	86	83	78	68	HFW-90-4T-10	58	79	86	91	94	90	83	72
HFW-63-6T-0.75	42	60	68	73	75	72	65	56	HFW-90-6T-2	58	79	86	91	94	90	83	72
HFW-63-6T-1	43	62	70	75	77	74	67	57	HFW-90-6T-3	56	70	77	82	85	81	74	63
HFW-71-4T-1.5	54	74	82	87	89	86	79	69	HFW-90-6T-4	57	72	79	84	87	83	76	65
HFW-71-4T-2	53	73	81	86	88	85	78	70	HFW-100-4T-7.5	64	84	92	97	99	96	89	78
HFW-71-4T-3	58	72	80	85	87	84	77	71	HFW-100-4T-10	62	82	90	95	97	94	87	76
HFW-71-4T-4	59	73	81	86	88	85	78	72	HFW-100-4T-15	61	81	89	94	96	93	86	75
HFW-71-6T-0.75	44	63	72	74	76	73	66	55	HFW-100-4T-20	63	83	91	96	98	95	88	77
HFW-71-6T-1	45	65	73	75	77	74	67	56	HFW-100-6T-3	61	72	80	85	87	84	77	66
HFW-71-6T-1.5	46	66	71	76	78	75	68	57	HFW-100-6T-4	64	72	80	85	87	84	77	66
HFW-80-4T-3	57	77	85	90	92	89	82	73	HFW-100-6T-5.5	64	73	81	86	88	85	78	67



ErP. BEP (Best Efficiency Point) characteristics

MC	Measurement Category	ηe[%]	Efficiency
EC	Efficiency Category	N	Degree of Efficiency
S	Static	[kW]	Electrical Power
T	Total	[m3/h]	Airflow
VSD	Variable-Speed Drive	[mmH2O]	Static or total pressure (According to EC)
SR	Specific Relationship	[RPM]	Speed

Model	MC	EC	VSD	SR	ηe [%]	N	[kW]	[m3/h]	[mmH ₂ O]	[RPM]
HFW-56-4T-1	A	S	NO	1.00	37.2%	44.1	0.837	7959	14.38	1438
HFW-63-4T-1	C	S	NO	1.00	49.8%	56.5	0.868	9291	17.07	1436
HFW-63-4T-1.5	C	S	NO	1.00	47.9%	53.7	1.193	10625	19.76	1447
HFW-63-4T-2	C	S	NO	1.00	42.3%	47.4	1.551	12026	20.03	1449
HFW-63-4T-3	B	T	NO	1.00	61.9%	65.8	2.447	20324	27.38	1439
HFW-63-4T-4	B	T	NO	1.00	62.6%	65.9	3.020	24239	28.64	1440
HFW-63-6T-0.75	B	T	NO	1.00	57.7%	65.4	0.611	12174	10.64	949
HFW-63-6T-1	B	T	NO	1.00	57.1%	63.7	0.930	15880	12.29	942
HFW-71-4T-1.5	C	S	NO	1.00	47.9%	53.4	1.346	12330	19.20	1440
HFW-71-4T-2	C	S	NO	1.00	48.4%	53.6	1.495	13405	19.83	1450
HFW-71-4T-3	C	S	NO	1.00	42.8%	46.8	2.369	17056	21.84	1441
HFW-71-4T-4	C	S	NO	1.00	40.7%	44.0	2.976	19369	22.96	1441
HFW-71-6T-0.75	C	S	NO	1.00	40.3%	47.7	0.678	10743	9.35	944
HFW-71-6T-1	C	S	NO	1.00	38.4%	45.2	0.842	12404	9.58	947
HFW-71-6T-1.5	C	S	NO	1.00	34.0%	40.1	1.103	14226	9.69	955
HFW-80-4T-3	C	S	NO	1.00	47.0%	51.0	2.417	16923	24.69	1440
HFW-80-4T-4	C	S	NO	1.00	44.5%	47.4	3.404	20444	27.19	1432
HFW-80-4T-5.5	C	S	NO	1.00	43.6%	46.1	4.011	22304	28.78	1457
HFW-80-6T-1.5	C	S	NO	1.00	40.2%	45.9	1.224	14613	12.35	951
HFW-80-6T-2	C	S	NO	1.00	39.2%	44.0	1.764	17576	14.46	962
HFW-80-6T-3	C	S	NO	1.00	37.1%	41.1	2.317	20444	15.44	956
HFW-90-4T-4	C	S	NO	1.00	51.9%	55.2	3.028	19656	29.36	1440
HFW-90-4T-5.5	C	S	NO	1.00	50.5%	53.0	4.049	25081	29.94	1456
HFW-90-4T-7.5	C	S	NO	1.00	47.7%	49.0	6.251	31521	34.72	1465
HFW-90-4T-10 IE3	C	S	NO	1.01	46.1%	46.8	7.730	35009	37.36	1467
HFW-90-6T-2	C	S	NO	1.00	45.8%	50.8	1.625	19416	14.08	965
HFW-90-6T-3	C	S	NO	1.00	41.1%	44.8	2.615	23753	16.64	950
HFW-90-6T-4	C	S	NO	1.00	37.7%	40.6	3.515	27183	17.92	970
HFW-100-4T-7.5	C	S	NO	1.00	52.1%	53.9	5.240	30466	32.94	1471
HFW-100-4T-10 IE3	C	S	NO	1.00	48.9%	49.4	8.112	37591	38.73	1466
HFW-100-4T-15 IE3	C	S	NO	1.01	44.7%	44.3	11.841	44571	43.65	1470
HFW-100-4T-20 IE3	C	S	NO	1.01	41.3%	40.1	15.684	50259	47.37	1471
HFW-100-6T-3	C	S	NO	1.00	45.0%	48.9	2.474	24629	16.62	953
HFW-100-6T-4	C	S	NO	1.00	43.9%	47.1	3.131	27632	18.28	974
HFW-100-6T-5.5	C	S	NO	1.00	38.9%	41.2	4.429	32373	19.56	971

Dimensions in mm

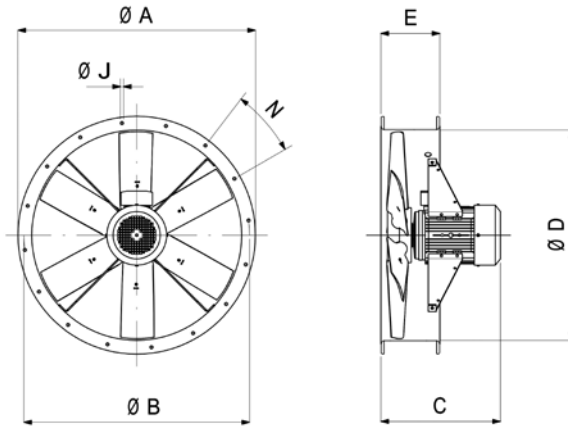

	ØA	ØB	C										ØD	E	ØJ	N	
			0.75	1	1.5	2	3	4	5.5	7.5	10	15					20
HFW-56-4	665	620	-	330	380	380	-	-	-	-	-	-	-	560	225	12	12x30°
HFW-56-6	665	620	330	-	-	-	-	-	-	-	-	-	-	560	225	12	12x30°
HFW-63-4	735	690	-	379	429	429	470	470	-	-	-	-	-	640	225	12	12x30°
HFW-63-6	735	690	379	429	-	-	-	-	-	-	-	-	-	640	225	12	12x30°
HFW-71-4	815	770	-	-	389	389	430	430	-	-	-	-	-	710	225	12	16x22°30'
HFW-71-6	815	770	339	389	389	-	-	-	-	-	-	-	-	710	225	12	16x22°30'
HFW-80-4	905	860	-	-	-	-	436	436	460	-	-	-	-	800	225	12	16x22°30'
HFW-80-6	905	860	-	-	395	436	460	-	-	-	-	-	-	800	225	12	16x22°30'
HFW-90-4	1018	970	-	-	-	-	401	425	485	525	-	-	-	900	225	15	16x22°30'
HFW-90-6	1018	970	-	-	-	401	425	485	-	-	-	-	-	900	225	15	16x22°30'
HFW-100-4	1118	1070	-	-	-	-	-	-	-	488	528	643	703	1000	225	15	16x22°30'
HFW-100-6	1118	1070	-	-	-	-	428	488	528	-	-	-	-	1000	225	15	16x22°30'

Characteristic Curves

Q = Airflow in m³/h, m³/s and cfm.

Pe = Static pressure in mmH₂O, Pa and inwg.

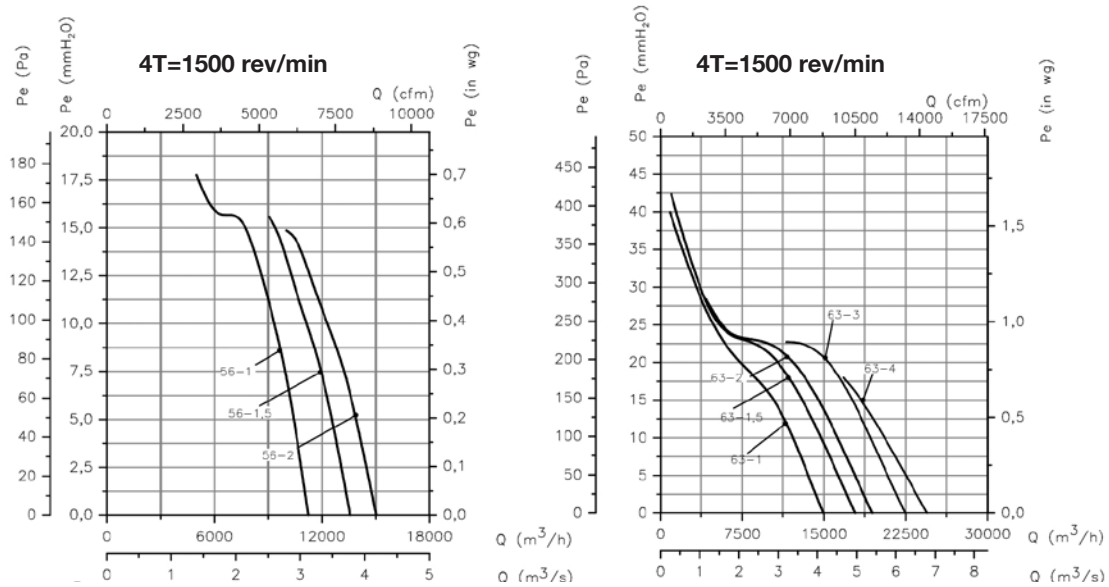

Characteristic Curves

Q = Airflow in m³/h, m³/s and cfm.

Pe = Static pressure in mmH₂O, Pa and inwg.

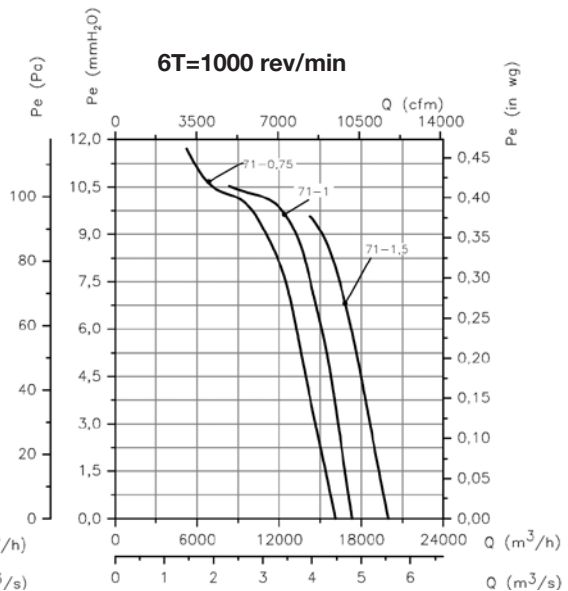
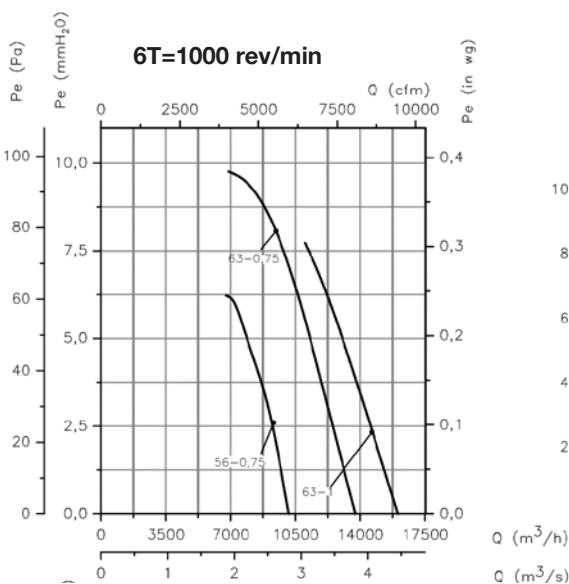
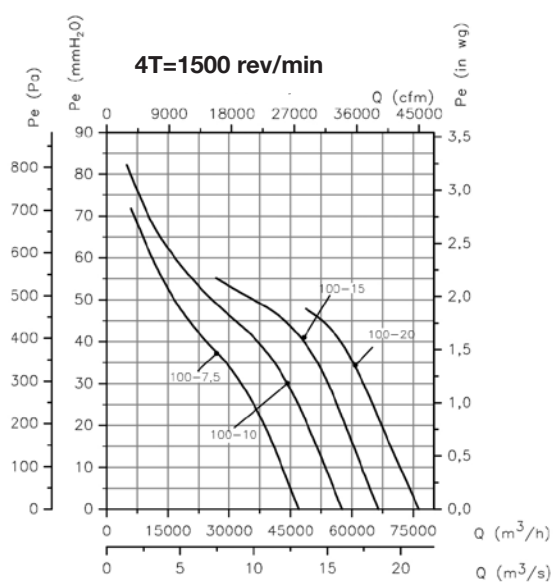
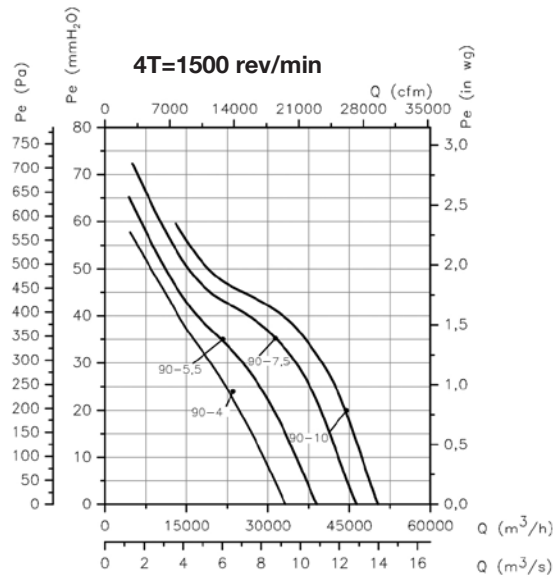
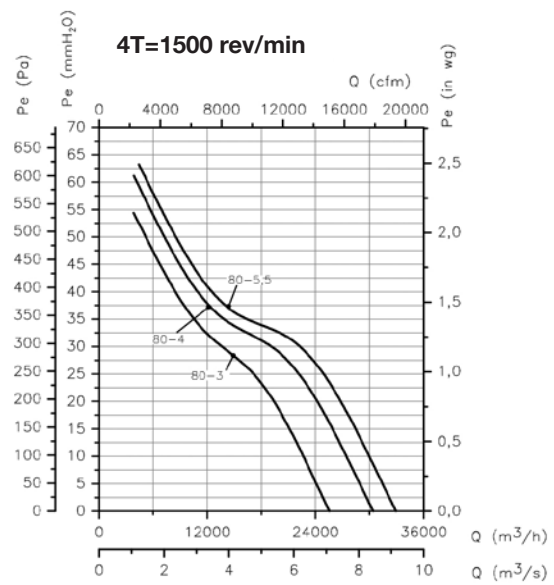
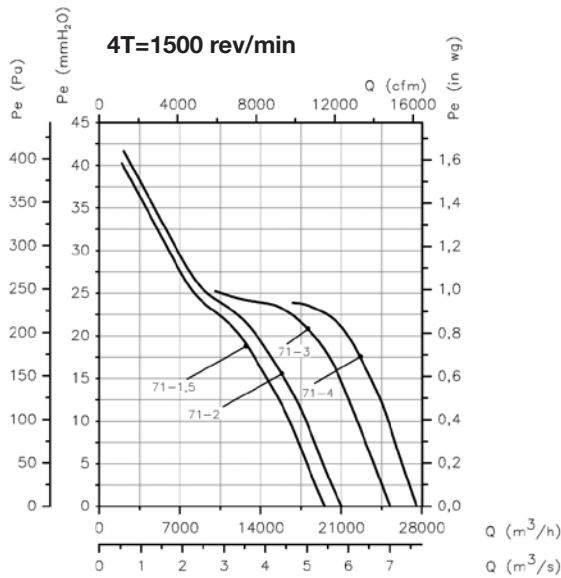

Characteristic Curves

Q = Airflow in m³/h, m³/s and cfm.

Pe = Static pressure in mmH₂O, Pa and inwg.

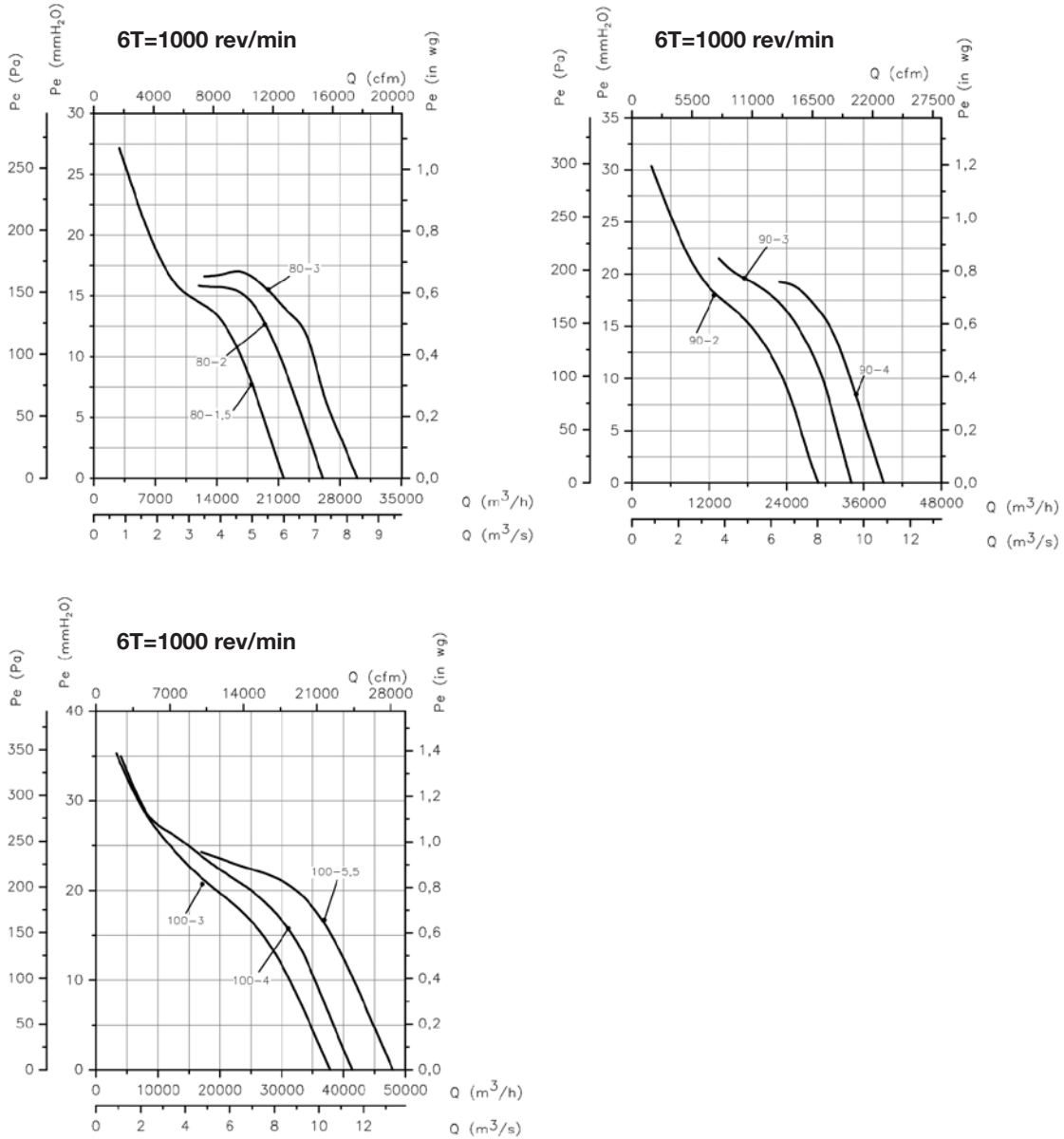

Accessories

See accessories section.



CJHCH



Axial ventilation units with soundproofed box

Ventilation units with internal soundproofing, with dismantlable inspection hatches.



Fan:

- Galvanised steel structure with thermal insulation and soundproofing
- Impellers in polyamide 6 reinforced with fibre glass
- Ventilation units designed for working in both horizontal and vertical positions
- Airflow direction from motor to impeller

Motor:

- IE2 efficiency motors for capacities equal to or over 0.75kW and below 7.5kW, except single-phase, 2 speed and 8 pole motors.
- IE3 efficiency motors for capacities equal to or over 7.5kW, except single-phase, 2 speed and 8 pole motors.
- Class F motors, with ball bearings and IP55 protection, except single-phase versions from size 45 to size 56, IP54 protection.
One-or two-speed depending on the model
- Single-phase 230V-50Hz and three-phase 230/400V-50Hz (up to 4kW) and 400/690V-50Hz (power over 4kW)
- Fan working temperature: -25°C + 50°C

Finish:

- Anticorrosive galvanized sheet steel.

On request:

- IE2 and IE3 efficiency motors for any power.
- AL version cast aluminium impellers
- Airflow direction from impeller to motor.
- 100% reversible impellers.
- Special windings for different voltages

Order code

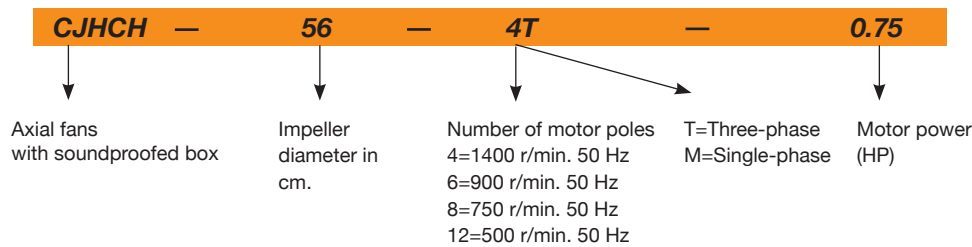

Technical characteristics

Model	Speed (r/min)	Maximum admissible current (A)			Installed capacity (kW)	Maximum airflow (m³/h)	Sound pres- sure level dB(A)	Approx. weight (Kg)
		230V	400V	690V				
CJHCH-56-4T-0.75	1380	2.92	1.69		0.55	11050	69	52.1
CJHCH-56-4M-0.75	1450	4.40			0.55	11050	69	52.1
CJHCH-56-4T-1	1410	3.10	1.79		0.75	12950	70	53.1
CJHCH-56-4/8T-1	1430 / 710		2.00 / 0.90		0.75 / 0.20	12950/6475	70/55	54.0
CJHCH-56-4T-1.5	1400	4.03	2.32		1.10	14000	71	56.8
CJHCH-56-4/8T-1.5	1440 / 710		2.90 / 1.30		1.10 / 0.25	14000/7000	71 / 56	55.3
CJHCH-56-4T-2	1430	5.96	3.44		1.50	15300	72	59.3
CJHCH-56-4/8T-2	1420 / 700		3.50 / 1.50		1.50 / 0.37	15300/7650	72 / 57	59.0
CJHCH-56-6T-0.33	900	1.51	0.87		0.25	8500	59	48.8
CJHCH-56-6M-0.33	950	1.85			0.25	8400	59	49.8
CJHCH-56-6T-0.5	900	2.24	1.30		0.37	9300	59	51.1
CJHCH-56-6T-0.75	900	2.99	1.73		0.55	10000	60	53.1
CJHCH-63-4T-1	1410	3.10	1.79		0.75	14150	70	57.5
CJHCH-63-4/8T-1	1430 / 710		2.00 / 0.90		0.75 / 0.20	14150/7075	70 / 55	58.4
CJHCH-63-4T-1.5	1400	4.03	2.32		1.10	17000	71	61.2
CJHCH-63-4/8T-1.5	1440 / 710		2.90 / 1.30		1.10 / 0.25	17000/8500	71 / 56	59.7
CJHCH-63-4T-2	1430	5.96	3.44		1.50	18900	72	63.7
CJHCH-63-4/8T-2	1420 / 700		3.50 / 1.50		1.50 / 0.37	18900/9450	72 / 57	63.4
CJHCH-63-4T-3	1445	8.36	4.83		2.20	22100	73	72.4
CJHCH-63-4/8T-3	1430 / 710		4.90 / 1.70		2.20 / 0.45	22100/11050	73 / 58	69.4
CJHCH-63-4T-4	1445	10.96	6.33		3.00	25400	74	74.4
CJHCH-63-4/8T-4	1430 / 710		6.50 / 2.30		3.00 / 0.60	25400/12700	74 / 59	72.8
CJHCH-63-6T-0.5	900	2.24	1.30		0.37	12150	62	55.5
CJHCH-63-6M-0.5	900	2.69			0.37	12150	62	55.5
CJHCH-63-6T-0.75	900	2.99	1.73		0.55	12750	63	57.5
CJHCH-63-6T-1	945	3.90	2.20		0.75	13800	64	64.2
CJHCH-63-6/12T-1	935 / 435		2.20 / 0.87		0.75 / 0.15	13800/6900	64 / 49	63.2
CJHCH-71-4T-1.5	1400	4.03	2.32		1.10	19750	75	77.3
CJHCH-71-4/8T-1.5	1440 / 710		2.90 / 1.30		1.10 / 0.25	19600/9800	75 / 60	75.8

Technical characteristics

Model	Speed (r/min)	Maximum admissible current (A)			Installed capacity (kW)	Maximum airflow (m³/h)	Sound pressure level dB(A)	Approx. weight (Kg)
		230V	400V	690V				
CJHCH-71-4T-2	1430	5.96	3.44		1.50	21100	76	79.8
CJHCH-71-4/8T-2	1420 / 700		3.50 / 1.50		1.50 / 0.37	21100/10550	76 / 61	79.5
CJHCH-71-4T-3	1445	8.36	4.83		2.20	23950	78	89.3
CJHCH-71-4/8T-3	1430 / 710		4.90 / 1.70		2.20 / 0.45	24150/12075	78 / 63	86.3
CJHCH-71-4T-4	1445	10.96	6.33		3.00	29400	79	91.3
CJHCH-71-4/8T-4	1430 / 710		6.50 / 2.30		3.00 / 0.60	29550/14775	79 / 64	89.7
CJHCH-71-6T-0.75	900	2.99	1.73		0.55	15150	65	73.2
CJHCH-71-6M-0.75	900	3.84			0.55	15150	65	73.2
CJHCH-71-6T-1	945	3.90	2.20		0.75	17250	66	80.3
CJHCH-71-6/12T-1	935 / 435		2.20 / 0.87		0.75 / 0.15	17150/8575	66 / 51	79.3
CJHCH-71-6T-1.5	945	4.88	2.82		1.10	20950	67	82.3
CJHCH-71-6/12T-1.5	950 / 470		3.00 / 1.15		1.10 / 0.18	20950/10475	67 / 52	81.3
CJHCH-80-4T-3	1445	8.36	4.83		2.20	28000	79	97.3
CJHCH-80-4/8T-3	1430 / 710		4.90 / 1.70		2.20 / 0.45	28000/14000	79 / 64	94.3
CJHCH-80-4T-4	1445	10.96	6.33		3.00	32700	80	99.3
CJHCH-80-4/8T-4	1430 / 710		6.50 / 2.30		3.00 / 0.60	32700/16350	80 / 65	97.7
CJHCH-80-4T-5.5	1440	14.10	8.12		4.00	37200	81	104.2
CJHCH-80-4/8T-5.5	1430 / 710		8.20 / 2.90		4.00 / 0.80	37200/18600	81 / 66	110.2
CJHCH-80-6T-1	945	3.90	2.20		0.75	20600	69	88.3
CJHCH-80-6/12T-1	935 / 435		2.20 / 0.87		0.75 / 0.15	20600/10300	69 / 54	87.3
CJHCH-80-6T-1.5	945	4.88	2.82		1.10	24250	70	90.3
CJHCH-80-6/12T-1.5	950 / 470		3.00 / 1.15		1.10 / 0.18	24250/12125	70 / 55	89.3
CJHCH-80-6T-2	955	6.42	3.71		1.50	28000	71	96.3
CJHCH-80-6/12T-2	970 / 470		4.60 / 1.90		1.50 / 0.25	28000/14000	71 / 56	106.2
CJHCH-80-6T-3	955	9.30	5.30		2.20	32500	72	101.2
CJHCH-80-6/12T-3	940 / 470		5.60 / 2.20		2.20 / 0.37	32500/16250	72 / 57	106.2
CJHCH-80-8T-0.5	700	2.77	1.60		0.37	16600	67	87.3
CJHCH-80-8T-0.75	695	3.53	2.04		0.55	19600	68	89.3
CJHCH-80-8T-1	705	4.68	2.70		0.75	22150	69	94.3
CJHCH-90-4T-4	1445	10.96	6.33		3.00	37750	84	123.2
CJHCH-90-4/8T-4	1430 / 710		6.50 / 2.30		3.00 / 0.60	37750/18875	84 / 69	121.6
CJHCH-90-4T-5.5	1440	14.10	8.12		4.00	41850	86	128.1
CJHCH-90-4/8T-5.5	1430 / 710		8.20 / 2.90		4.00 / 0.80	41850/20925	86 / 71	134.1
CJHCH-90-4T-7.5	1440		11.60	6.72	5.50	47000	88	143.5
CJHCH-90-4/8T-7.5	1450 / 720		11.80 / 3.80		5.50 / 1.10	47000/23500	88 / 73	153.5
CJHCH-90-4T-10 IE3	1465		13.90	8.06	7.50	53000	89	170.5
CJHCH-90-4/8T-10	1460 / 725		15.30 / 5.40		7.50 / 1.50	53000/26500	89 / 74	158.5
CJHCH-90-6T-2	955	6.42	3.71		1.50	30000	75	120.2
CJHCH-90-6/12T-2	970 / 470		4.60 / 1.90		1.50 / 0.25	30000/15000	75 / 60	130.1
CJHCH-90-6T-3	955	9.30	5.30		2.20	35000	76	125.1
CJHCH-90-6/12T-3	940 / 470		5.60 / 2.20		2.20 / 0.37	35000/17500	76 / 61	130.1
CJHCH-90-6T-4	960	12.70	7.30		3.00	40000	77	148.5
CJHCH-90-6/12T-4	960 / 480		9.00 / 3.50		3.00 / 0.55	40000/20000	77 / 62	147.5
CJHCH-90-8T-1	705	4.68	2.70		0.75	22400	69	118.2
CJHCH-90-8T-1.5	705	5.63	3.25		1.10	24150	70	121.2
CJHCH-90-8T-2	705	7.10	4.10		1.50	26300	71	132.1
CJHCH-90-8T-3	705	9.53	5.50		2.20	30150	72	158.5
CJHCH-100-4T-7.5	1440		11.60	6.72	5.50	52500	89	152.1
CJHCH-100-4/8T-7.5	1450 / 720		11.80 / 3.80		5.50 / 1.10	52500/26250	89 / 74	162.1
CJHCH-100-4T-10 IE3	1465		13.90	8.06	7.50	58500	90	179.1
CJHCH-100-4/8T-10	1460 / 725		15.30 / 5.40		7.50 / 1.50	58500/29250	90 / 75	167.1
CJHCH-100-4T-15 IE3	1470		20.90	12.10	11.00	68000	91	210.7
CJHCH-100-4/8T-15	1470 / 725		23.20 / 8.70		11.00 / 2.80	68000/34000	91 / 76	185.7
CJHCH-100-4T-20 IE3	1465		27.90	16.20	15.00	71850	92	221.7
CJHCH-100-4/8T-20	1460 / 725		31.72 / 11.75		15.00 / 3.80	72450/36225	92 / 77	200.7
CJHCH-100-6T-3	955	9.30	5.30		2.20	40500	80	133.0
CJHCH-100-6/12T-3	940 / 470		5.60 / 2.20		2.20 / 0.37	40500/20250	80 / 65	138.0
CJHCH-100-6T-4	960	12.70	7.30		3.00	46950	81	157.1
CJHCH-100-6/12T-4	960 / 480		9.00 / 3.50		3.00 / 0.55	46950/23475	81 / 66	156.1
CJHCH-100-6T-5.5	960	16.50	9.46		4.00	52000	82	165.1
CJHCH-100-6/12T-5.5	970 / 480		11.00 / 4.00		4.00 / 0.65	52000/26000	82 / 67	161.1
CJHCH-100-8T-1.5	720	6.32	3.65		1.10	32500	74	128.3
CJHCH-100-8T-2	705	7.10	4.10		1.50	33850	75	140.0
CJHCH-100-8T-3	705	9.53	5.50		2.20	35150	75	167.1
CJHCH-100-8T-4	705	12.82	7.40		3.00	37800	76	175.1

Acoustic features

The specified values are determined according to free field measurements of pressure and sound levels in dB(A) at an equivalent distance of twice the fan's span plus the impeller's diameter, with a minimum of 1.5 m.

Sound power Lw(A) spectrum in dB(A) via frequency band in Hz.

Modelo	63	125	250	500	1000	2000	4000	8000	Modelo	63	125	250	500	1000	2000	4000	8000
56-4-0.75	44	64	72	77	79	76	69	58	80-6-1.5	47	67	75	80	82	79	72	61
56-4-1	45	65	73	78	80	77	70	59	80-12-1.5 (2v)	32	52	60	65	67	64	57	46
56-8-1 (2v)	30	50	58	63	65	62	55	44	80-6-2	48	68	76	81	83	80	73	62
56-4-1.5	46	66	74	79	81	78	71	60	80-12-2 (2v)	33	53	61	66	68	65	58	47
56-8-1.5 (2v)	31	51	59	64	66	63	56	45	80-6-3	49	69	77	82	84	81	74	63
56-4-2	47	67	75	80	82	79	72	61	80-12-3 (2v)	34	54	62	67	69	66	59	48
56-8-2 (2v)	32	52	60	65	67	64	57	46	80-8-0.5	44	64	72	77	79	76	69	58
56-6-0.33	34	54	62	67	69	66	59	48	80-8-0.75	45	65	73	78	80	77	70	59
56-6-0.5	34	54	62	67	69	66	59	48	80-8-1	46	66	74	79	81	78	71	60
56-6-0.75	35	55	63	68	70	67	60	49	90-4-4	62	83	90	95	98	94	87	76
63-4-1	47	67	75	80	82	79	72	61	90-8-4 (2v)	47	68	75	80	83	79	72	61
63-8-1 (2v)	32	52	60	65	67	64	57	46	90-4-5.5	64	85	92	97	100	96	89	78
63-4-1.5	48	68	76	81	83	80	73	62	90-8-5.5 (2v)	49	70	77	82	85	81	74	63
63-8-1.5 (2v)	33	53	61	66	68	65	58	47	90-4-7.5	66	87	94	99	102	98	91	80
63-4-2	49	69	77	82	84	81	74	63	90-8-7.5 (2v)	51	72	79	84	87	83	76	65
63-8-2 (2v)	34	54	62	67	69	66	59	48	90-4-10	67	88	95	100	103	99	92	81
63-4-3	50	70	78	83	85	82	75	64	90-8-10 (2v)	52	73	80	85	88	84	77	66
63-8-3 (2v)	35	55	63	68	70	67	60	49	90-6-2	53	74	81	86	89	85	78	67
63-4-4	51	71	79	84	86	83	76	65	90-12-2 (2v)	38	59	66	71	74	70	63	52
63-8-4 (2v)	36	56	64	69	71	68	61	50	90-6-3	54	75	82	87	90	86	79	68
63-6-0.5	39	59	67	72	74	71	64	53	90-12-3 (2v)	39	60	67	72	75	71	64	53
63-6-0.75	40	60	68	73	75	72	65	54	90-6-4	55	76	83	88	91	87	80	69
63-6-1	41	61	69	74	76	73	66	55	90-12-4 (2v)	40	61	68	73	76	72	65	54
63-12-1 (2v)	26	46	54	59	61	58	51	40	90-8-1	47	68	75	80	83	79	72	61
71-4-1.5	52	72	80	85	87	84	77	66	90-8-1.5	48	69	76	81	84	80	73	62
71-8-1.5 (2v)	37	57	65	70	72	69	62	51	90-8-2	49	70	77	82	85	81	74	63
71-4-2	53	73	81	86	88	85	78	67	90-8-3	50	71	78	83	86	82	75	64
71-8-2 (2v)	38	58	66	71	73	70	63	52	100-4-7.5	69	89	97	102	104	101	94	83
71-4-3	55	75	83	88	90	87	80	69	100-8-7.5 (2v)	54	74	82	87	89	86	79	68
71-8-3 (2v)	40	60	68	73	75	72	65	54	100-4-10	70	90	98	103	105	102	95	84
71-4-4	56	76	84	89	91	88	81	70	100-8-10 (2v)	55	75	83	88	90	87	80	69
71-8-4 (2v)	41	61	69	74	76	73	66	55	100-4-15	71	91	99	104	106	103	96	85
71-6-0.75	42	62	70	75	77	74	67	56	100-8-15 (2v)	56	76	84	89	91	88	81	70
71-6-1	43	63	71	76	78	75	68	57	100-4-20	72	92	100	105	107	104	97	86
71-12-1 (2v)	28	48	56	61	63	60	53	42	100-8-20 (2v)	57	77	85	90	92	89	82	71
71-6-1.5	44	64	72	77	79	76	69	58	100-6-3	60	80	88	93	95	92	85	74
71-12-1.5 (2v)	29	49	57	62	64	61	54	43	100-12-3 (2v)	45	65	73	78	80	77	70	59
80-4-3	56	76	84	89	91	88	81	70	100-6-4	61	81	89	94	96	93	86	75
80-8-3 (2v)	41	61	69	74	76	73	66	55	100-12-4 (2v)	46	66	74	79	81	78	71	60
80-4-4	57	77	85	90	92	89	82	71	100-6-5.5	62	82	90	95	97	94	87	76
80-8-4 (2v)	42	62	70	75	77	74	67	56	100-12-5.5 (2v)	47	67	75	80	82	79	72	61
80-4-5.5	58	78	86	91	93	90	83	72	100-8-1.5	54	74	82	87	89	86	79	68
80-8-5.5 (2v)	43	63	71	76	78	75	68	57	100-8-2	55	75	83	88	90	87	80	69
80-6-1	46	66	74	79	81	78	71	60	100-8-3	55	75	83	88	90	87	80	69
80-12-1 (2v)	31	51	59	64	66	63	56	45	100-8-4	56	76	84	89	91	88	81	70

Dimensions in mm

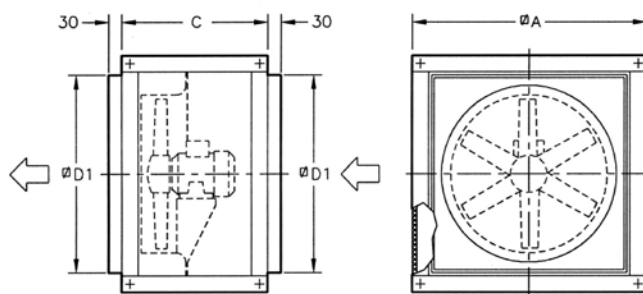

Model	ØA	C	ØD1
CJHCH-56/63	825	550	690
CJHCH-71/80	1000	650	850
CJHCH-90/100	1200	750	1050

Characteristic curves and efficiency data

See curves and efficiency data HCH-HCT series

Accessories

See accessories section.



HTP

Cased high-pressure axial fans

Robust cased axial high-pressure fans, especially designed for mining installations with large load losses



Hélice de alta presión

Fan:

- Sheet steel thick long casing
- Motor base welded to the casing
- Guidelines for high aerodynamic performance for pressure gain
- Optimum surface protection by means of high-quality steel.
- High-performance, cast aluminium impeller.
- Airflow direction from impeller to motor
- Electrical connection in outside terminal board.

Motor:

- IE2 efficiency motors for capacities equal to or over 0.75kW and below 7.5kW, except single-phase, 2 speed and 8 pole motors.
- IE3 efficiency motors for capacities equal to or over 7.5kW, except single-phase, 2 speed and 8 pole motors
- Class F motors, with ball bearings, IP-55 protection
- Three-phase 230/400V-50Hz. (up to 4kW) and 400/690V-50Hz. (power over 4kW)
- Fan working temperature: -20°C +70°C

Finish:

- High-protection, anti-corrosion steel, specially primed and high-quality paint for corrosive environments.

On request:

- Standardised IP-55 motors, ATEX motors and two speeds
- Made entirely from stainless steel.
- Hot-rolled galvanised steel construction
- ATEX certification, Category 2
- IE2 and IE3 efficiency motors for any power



Order code

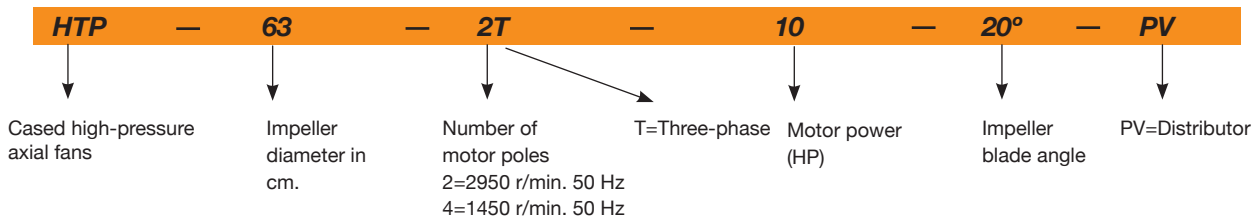

Technical characteristics

Model	Speed (r/min)	Maximum admissible current (A)			Installed capacity (kW)	Maximum airflow (m³/h)	Approx. weight (Kg)	NPS dB(A)
		230V	400V	690V				
HTP-50-2T-4	2900	10.18	5.88	-	3.00	13850	49	82
HTP-50-2T-5.5	2870	13.60	7.82	-	4.00	16450	65	83
HTP-56-2T-5.5	2870	13.60	7.82	-	4.00	18050	69	88
HTP-56-2T-10 IE3	2930		14.10	8.17	7.50	25500	143	89
HTP-63-2T-10 IE3	2930		14.10	8.17	7.50	23850	128	94
HTP-63-2T-15 IE3	2945		20.00	11.60	11.00	29400	199	94
HTP-63-2T-20 IE3	2945		27.70	16.10	15.00	34400	205	97
HTP-63-2T-25 IE3	2945		33.90	19.70	18.50	37200	216	98
HTP-63-2T-30 IE3	2950		39.70	23.00	22.00	39800	208	99
HTP-63-4T-1.5	1400	4.03	2.32	-	1.10	12850	92	79
HTP-63-4T-2	1430	5.96	3.44	-	1.50	15650	93	79
HTP-63-4T-3	1445	8.36	4.83	-	2.20	18600	101	83
HTP-63-4T-4	1445	10.96	6.33	-	3.00	19900	104	84
HTP-71-2T-15 IE3	2945		20.00	11.60	11.00	32850	216	93
HTP-71-2T-20 IE3	2945		27.70	16.10	15.00	39250	222	95
HTP-71-2T-25 IE3	2945		33.90	19.70	18.50	43450	233	95
HTP-71-2T-30 IE3	2950		39.70	23.00	22.00	45500	225	95
HTP-71-2T-40 IE3	2960		54.50	31.60	30.00	52550	333	98
HTP-71-4T-2	1445	8.36	4.83	-	2.20	17500	110	83
HTP-71-4T-3	1445	8.36	4.83	-	2.20	20650	118	83
HTP-71-4T-4	1445	10.96	6.33	-	3.00	23950	121	84
HTP-71-4T-5.5	1440	14.10	8.12	-	4.00	27400	127	87
HTP-71-4T-7.5	1440	-	11.60	6.72	5.50	31700	141	90
HTP-80-4T-4	1445	10.96	6.33	-	3.00	19300	146	86

Technical characteristics

Model	Speed (r/min)	Maximum admissible current (A)			Installed capacity (kW)	Maximum airflow (m³/h)	Approx. weight (Kg)	NPS dB(A)
		230V	400V	690V				
HTP-80-4T-5.5	1440	14.10	8.12	-	4.00	22850	152	86
HTP-80-4T-7.5	1440	-	11.60	6.72	5.50	28000	166	86
HTP-80-4T-10 IE3	1465		13.90	8.06	7.50	31500	193	87
HTP-80-4T-15 IE3	1470		20.90	12.10	11.00	40000	242	91
HTP-90-4T-7.5	1440	-	11.60	6.72	5.50	27450	196	90
HTP-90-4T-10 IE3	1465		13.90	8.06	7.50	32500	223	90
HTP-90-4T-15 IE3	1470		20.90	12.10	11.00	42200	272	90
HTP-90-4T-20 IE3	1465		27.90	16.20	15.00	50050	283	94
HTP-90-4T-25 IE3	1470		35.10	20.30	18.50	54550	326	95
HTP-90-4T-30 IE3	1470		41.00	23.80	22.00	61750	326	97
HTP-100-4T-15 IE3	1470		20.90	12.10	11.00	46100	307	93
HTP-100-4T-20 IE3	1465		27.90	16.20	15.00	56300	318	93
HTP-100-4T-25 IE3	1470		35.10	20.30	18.50	59900	361	93
HTP-100-4T-30 IE3	1470		41.00	23.80	22.00	69900	361	96
HTP-100-4T-40 IE3	1480		57.10	33.10	30.00	80500	429	98
HTP-125-4T-40 IE3	1480		57.10	33.10	30.00	81000	531	100
HTP-125-4T-50 IE3	1480		69.20	40.10	37.00	96800	602	100
HTP-125-4T-60 IE3	1475		80.90	46.90	45.00	105050	658	100
HTP-125-4T-75 IE3	1480		98.60	57.20	55.00	127800	664	100
HTP-125-4T-100 IE3	1485		134.00	77.70	75.00	147350	784	104
HTP-125-4T-125 IE3	1485		158.00	91.60	90.00	156800	823	105

Acoustic features

The specified values are determined according to free field measurements of pressure and sound levels in dB(A) at an equivalent distance of twice the fan's span plus the impeller's diameter, with a minimum of 1.5 m.

Sound power Lw(A) spectrum in dB(A) via frequency band in Hz.

Model	LpdB(A)	63	125	250	500	1000	2000	4000	8000	Model	LpdB(A)	63	125	250	500	1000	2000	4000	8000
HTP-50-2T-4	80	57	77	85	90	92	89	82	71	HTP-80-4T-4	86	58	75	86	95	96	96	93	86
HTP-50-2T-5.5	81	58	78	86	91	93	90	83	72	HTP-80-4T-5.5	86	58	76	86	95	96	96	93	86
HTP-56-2T-5.5	86	63	83	91	96	98	95	88	77	HTP-80-4T-7.5	86	58	76	86	95	96	96	93	86
HTP-56-2T-10	87	64	84	92	97	99	96	89	78	HTP-80-4T-10	87	59	77	87	97	98	98	94	88
HTP-63-2T-10	94	70	82	92	104	105	104	99	91	HTP-80-4T-15	91	63	81	91	101	102	102	99	92
HTP-63-2T-15	94	70	82	92	104	105	104	99	91	HTP-90-4T-7.5	90	62	79	90	99	100	100	97	90
HTP-63-2T-20	97	73	85	95	107	108	107	102	94	HTP-90-4T-10	90	62	80	90	99	100	100	97	90
HTP-63-2T-25	98	74	86	96	108	109	108	103	95	HTP-90-4T-15	90	62	80	90	100	101	101	98	91
HTP-63-2T-30	99	75	87	97	109	110	109	104	96	HTP-90-4T-20	94	66	83	94	103	104	104	101	94
HTP-63-4T-1.5	79	55	67	77	89	90	89	84	76	HTP-90-4T-25	95	67	85	95	104	105	105	102	95
HTP-63-4T-2	79	55	67	77	89	90	89	84	76	HTP-90-4T-30	97	69	87	97	107	108	108	104	98
HTP-63-4T-3	83	59	71	81	93	94	93	88	80	HTP-100-4T-15	93	65	83	93	102	103	103	100	93
HTP-63-4T-4	84	60	72	82	94	95	94	89	81	HTP-100-4T-20	93	65	82	93	102	103	103	100	93
HTP-71-2T-15	93	65	83	93	102	104	103	100	93	HTP-100-4T-25	93	65	83	93	102	103	103	100	93
HTP-71-2T-20	95	67	85	95	104	106	105	102	95	HTP-100-4T-30	96	67	85	96	105	106	106	103	96
HTP-71-2T-25	95	67	85	95	104	106	105	102	95	HTP-100-4T-40	98	70	88	98	107	108	108	105	98
HTP-71-2T-30	95	67	85	95	104	106	105	102	95	HTP-125-4T-40	100	72	89	100	109	110	110	107	100
HTP-71-2T-40	98	70	88	98	107	109	108	105	98	HTP-125-4T-50	100	72	90	100	109	110	110	107	100
HTP-71-4T-2	83	55	73	83	92	93	93	90	83	HTP-125-4T-60	100	72	89	100	109	110	110	107	100
HTP-71-4T-3	83	55	72	83	92	93	93	90	83	HTP-125-4T-75	100	72	90	100	110	111	111	108	101
HTP-71-4T-4	84	56	74	84	94	95	95	91	85	HTP-125-4T-100	104	76	93	104	113	114	114	111	104
HTP-71-4T-5.5	87	59	77	87	97	98	98	95	88	HTP-125-4T-125	105	77	95	105	114	115	115	112	105
HTP-71-4T-7.5	90	62	80	90	100	101	101	97	91										

Dimensions in mm

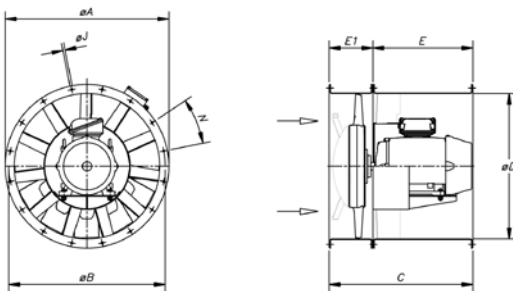

Model	Power	ØA	ØB	ØD	E	E1	C	ØJ	N
HTP-50-2T	4/5/5	600	560	514	-	-	400	12	12x30°
HTP-56-2T	5/5/10	660	620	560	-	-	500	12	12x30°
HTP-63-2T	10/15/20/25/30	730	690	640	650	220	870	13	12x30°
HTP-63-4T	1'5/2/3/4	730	690	640	340	220	560	13	12x30°
HTP-71-2T	15/20/25/30/40	810	770	710	700	240	940	13	16x22°30'
HTP-71-4T	2/3/4/5/5/7/5	810	770	710	420	240	660	13	16x22°30'
HTP-80-4T	4 / 5/5	900	860	800	360	240	600	15	16x22°30'
HTP-80-4T	7'5 / 10 / 15	900	860	800	600	240	840	15	16x22°30'
HTP-90-4T	7'5 / 10	1015	970	900	420	250	670	15	16x22°30'
HTP-90-4T	15 / 20 / 25 / 30	1015	970	900	650	250	900	15	16x22°30'
HTP-100-4T	15 / 20	1115	1070	1000	600	270	870	15	16x22°30'
HTP-100-4T	25 / 30 / 40	1115	1070	1000	700	270	970	15	16x22°30'
HTP-125	40 / 50 / 60 / 75	1365	1320	1250	900	300	1100	15	20x18°
HTP-125	100 / 125	1365	1320	1250	950	300	1250	15	20x18°

EXAMPLE OF SELECTION

Characteristic Curves

Q = Airflow in m³/h, m³/s and cfm.

Pe = Static pressure in mmH₂O, Pa and inwg.

HTP-63-4T

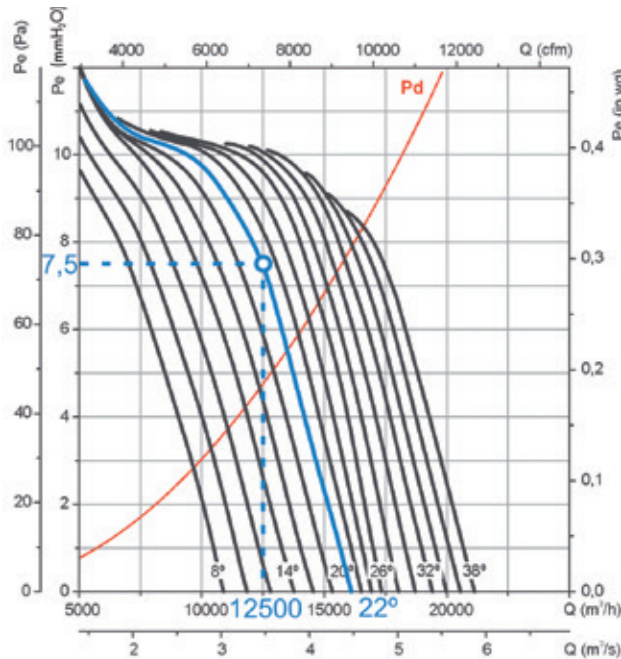

Initial data

- Working point:
- Airflow: 12,500 m³/h
- Load loss: 7.5 mmH₂O

Steps for selecting equipment

On the pressure graph:

- 1 Mark the working point, defined by the airflow (12,500 m³/h) and the load loss (7.5 mmH₂O).
- 2 Select the curve of the equipment which is closest above the working point. In our case, a curve with a blade angle of 22° is obtained.

On the power graph:

- 3 Mark the working point, defined by the airflow (12,500 m³/h) and the selected blade angle (22°).
- 4 Read the absorbed power on the power axis on the left. $P_a = 560$ W at the working point.
- 5 Look for the straight red line which is closest to the working point above. On the right-hand side of the graph, the value of the installed motor power is obtained. In our case, this is 0.75 kW or 1 HP

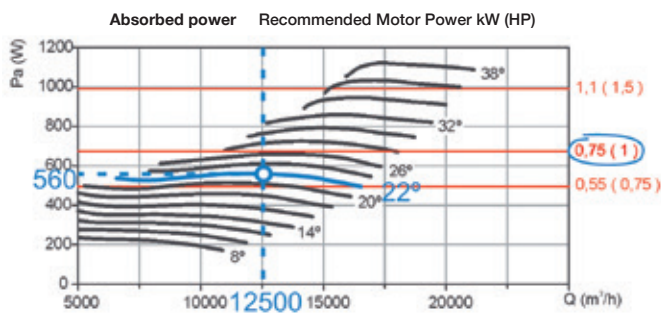

EXAMPLE OF ORDER CODE

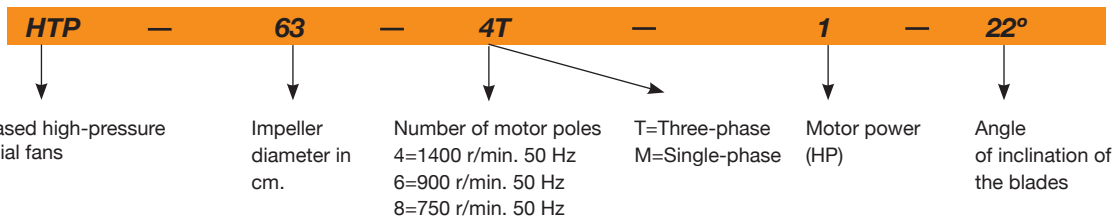

Characteristic Curves

Q = Airflow in m³/h, m³/s and cfm.

Pe = Static pressure in mmH₂O, Pa and inwg.

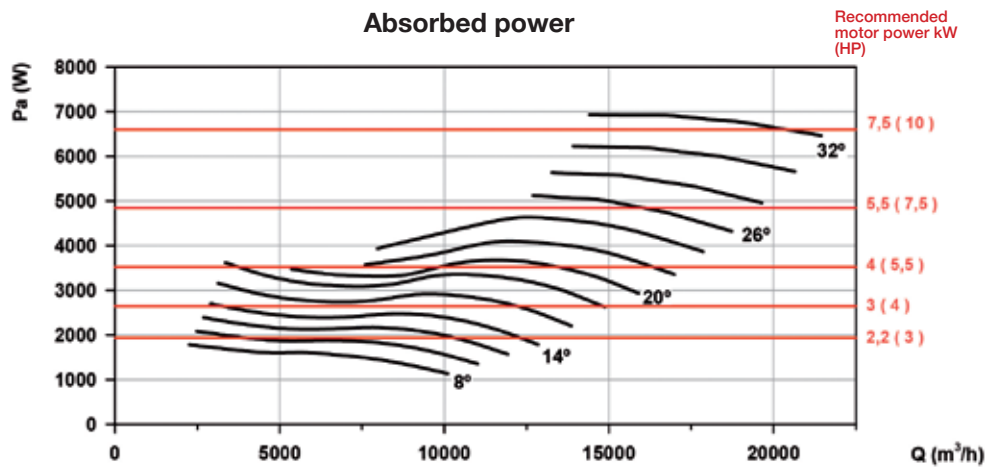
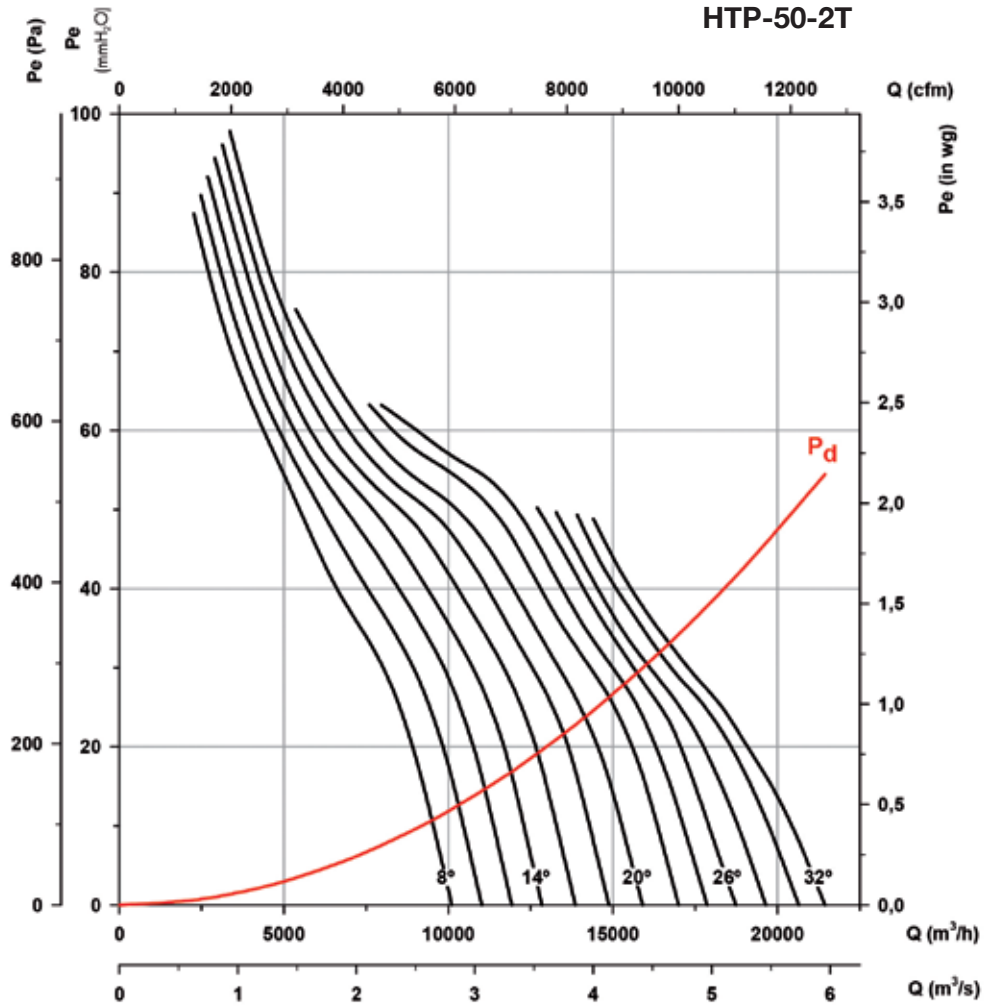

Available features best efficiency point (BEP) at the end of the series.

Characteristic Curves

Q = Airflow in m³/h, m³/s and cfm.

Pe = Static pressure in mmH₂O, Pa and inwg.

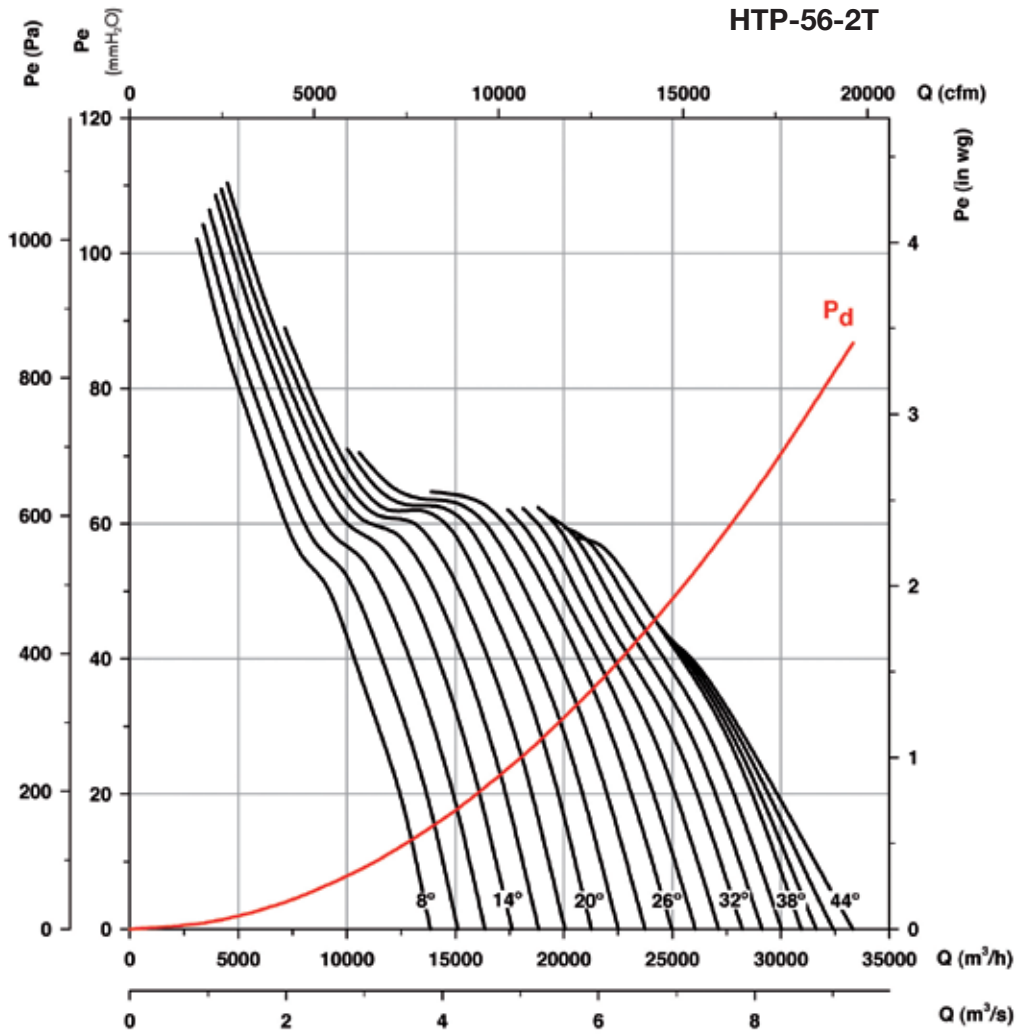

Absorbed power

Recommended motor power kW (HP)

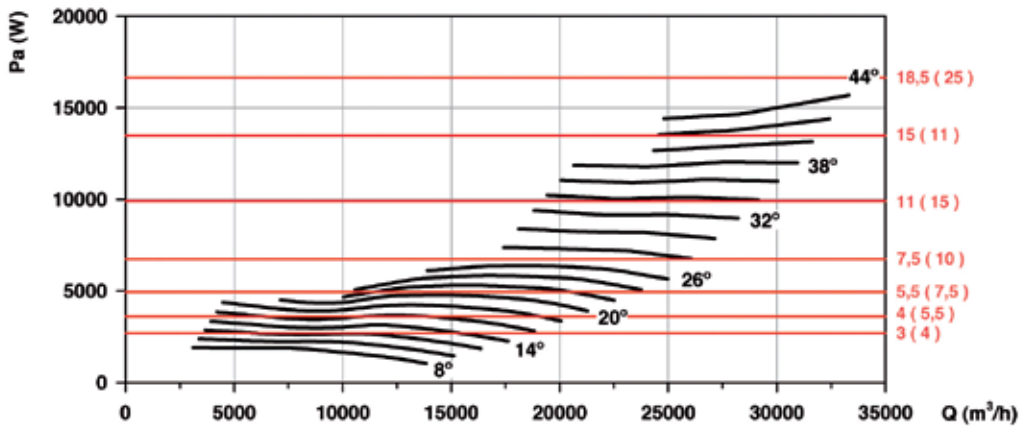

Available features best efficiency point (BEP) at the end of the series.

Characteristic Curves

Q = Airflow in m³/h, m³/s and cfm.

Pe = Static pressure in mmH₂O, Pa and inwg.

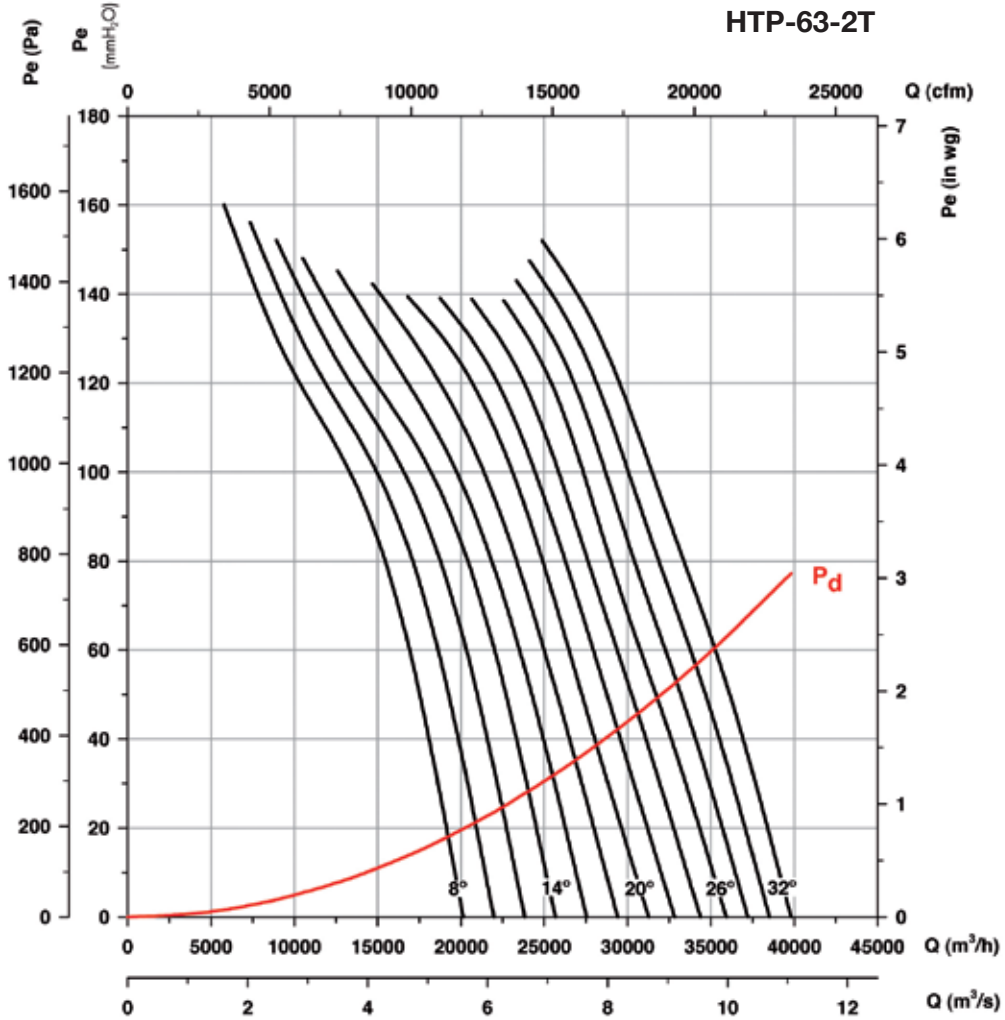

Absorbed power

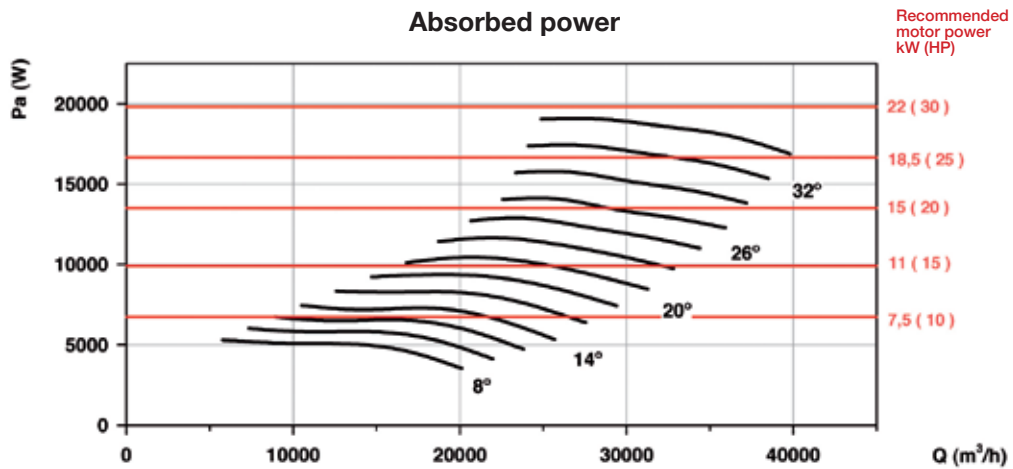

Available features best efficiency point (BEP) at the end of the series.

Characteristic Curves

Q = Airflow in m³/h, m³/s and cfm.

Pe = Static pressure in mmH₂O, Pa and inwg.

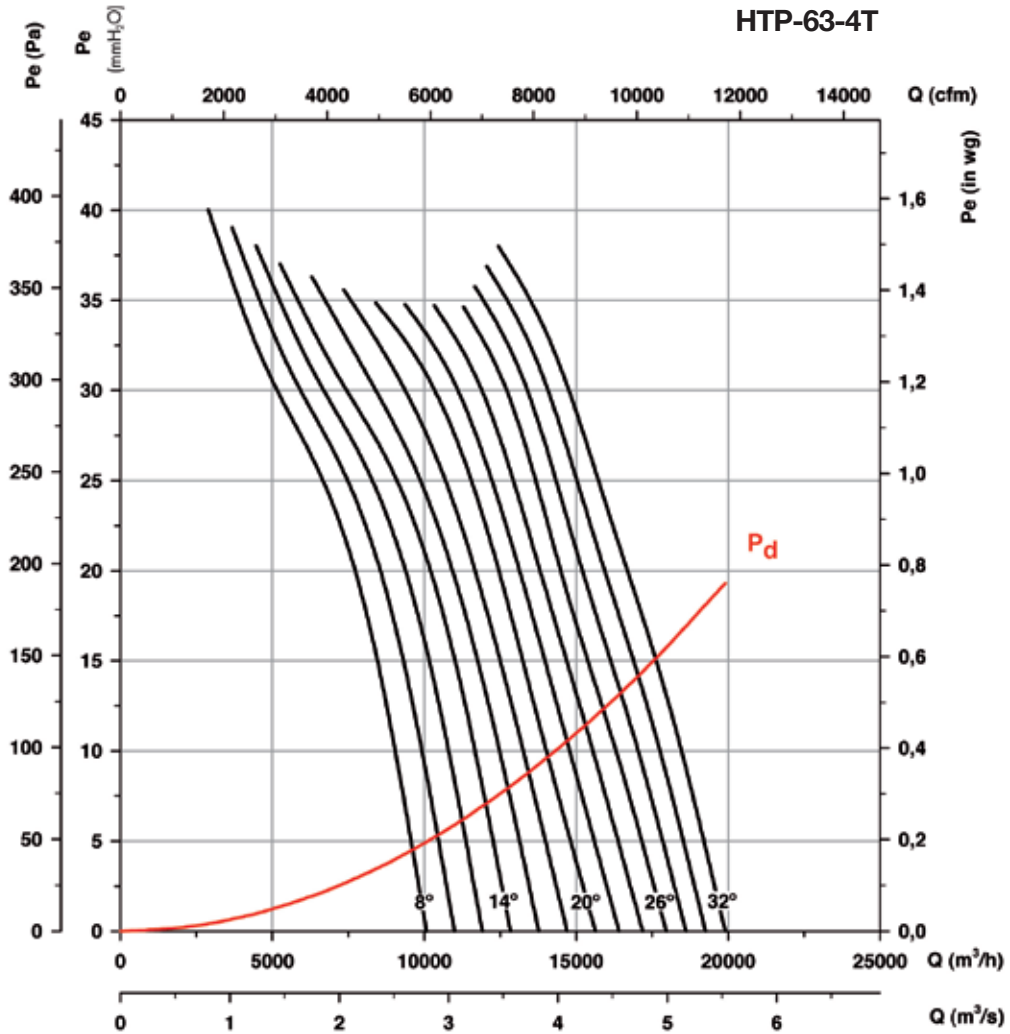

Absorbed power

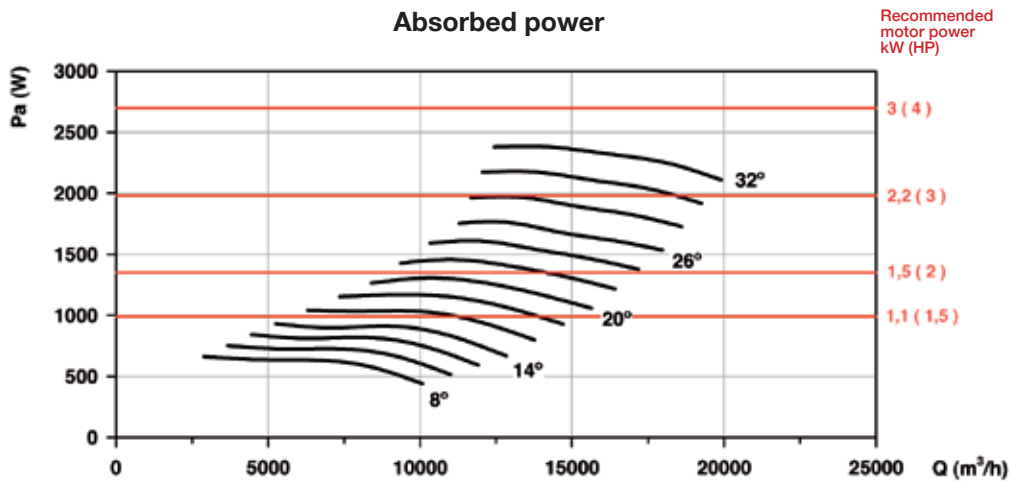

Available features best efficiency point (BEP) at the end of the series.

Characteristic Curves

Q = Airflow in m³/h, m³/s and cfm.

Pe = Static pressure in mmH₂O, Pa and inwg.

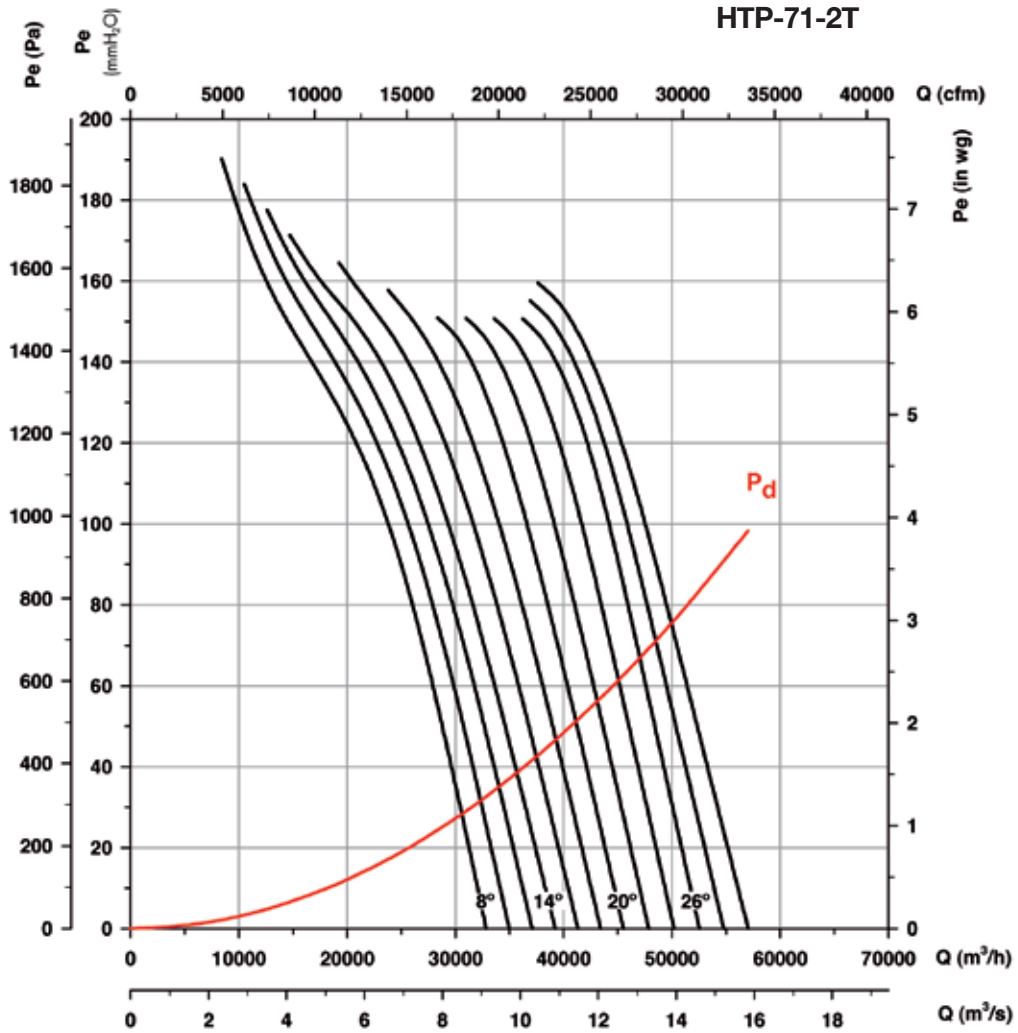

Absorbed power

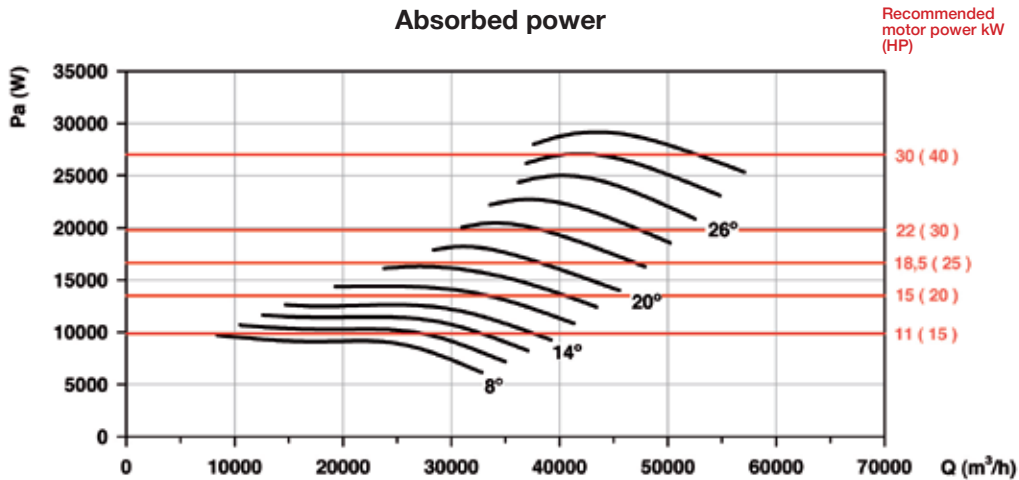

Available features best efficiency point (BEP) at the end of the series.

Characteristic Curves

Q = Airflow in m³/h, m³/s and cfm.

Pe = Static pressure in mmH₂O, Pa and inwg.

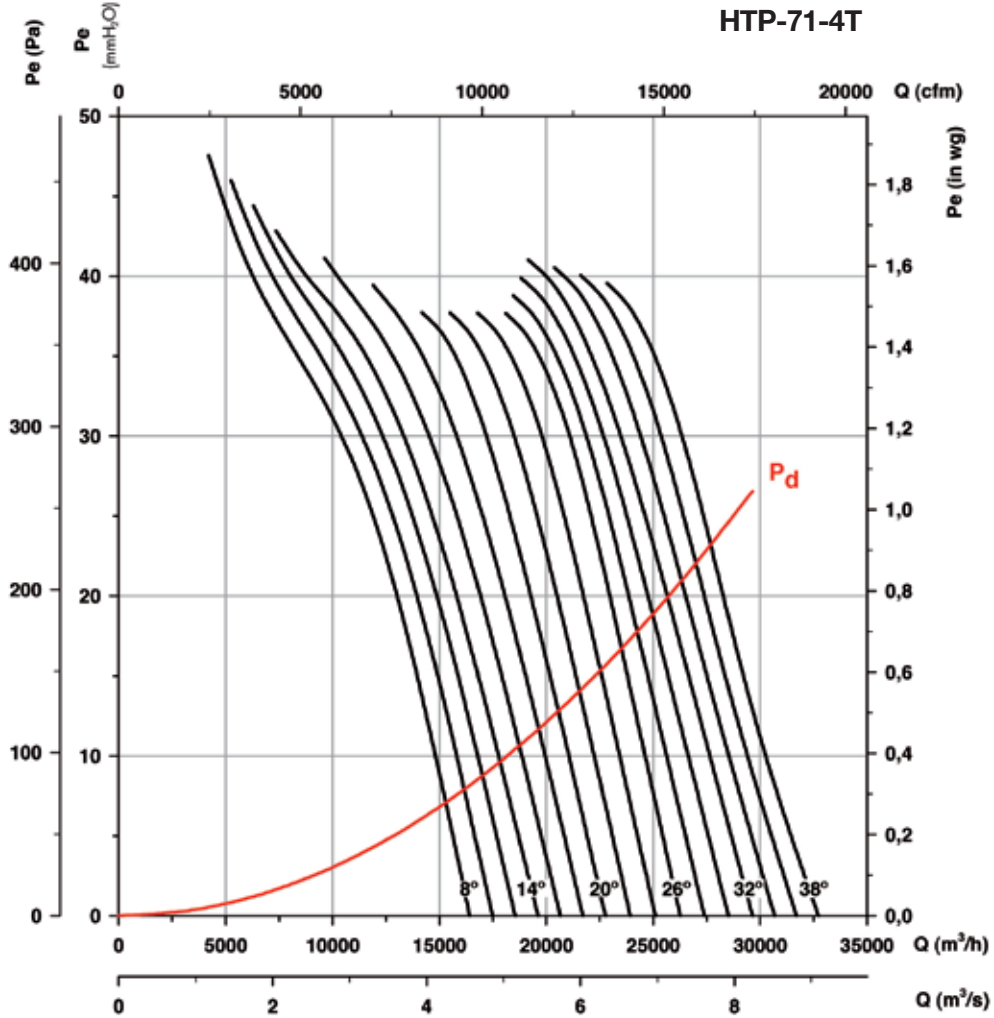

Absorbed power

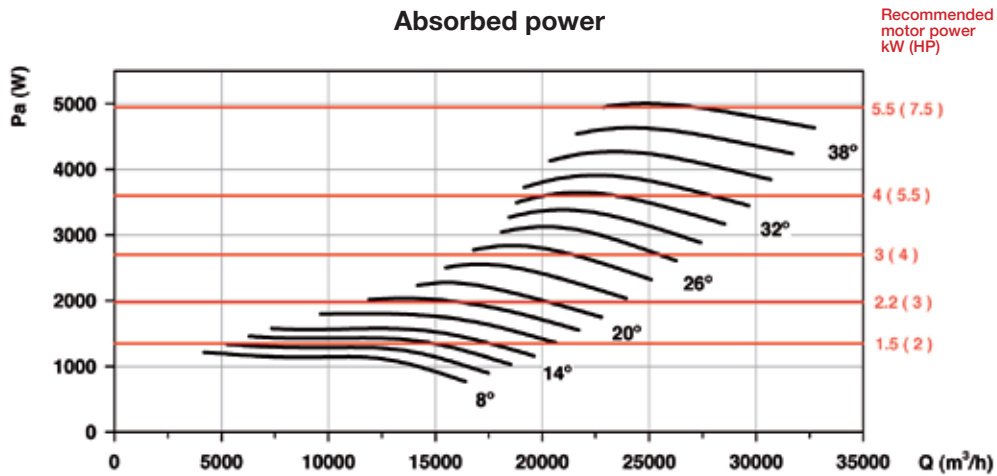

Recommended motor power
kW (HP)



Available features best efficiency point (BEP) at the end of the series.

Characteristic Curves

Q = Airflow in m³/h, m³/s and cfm.

Pe = Static pressure in mmH₂O, Pa and inwg.

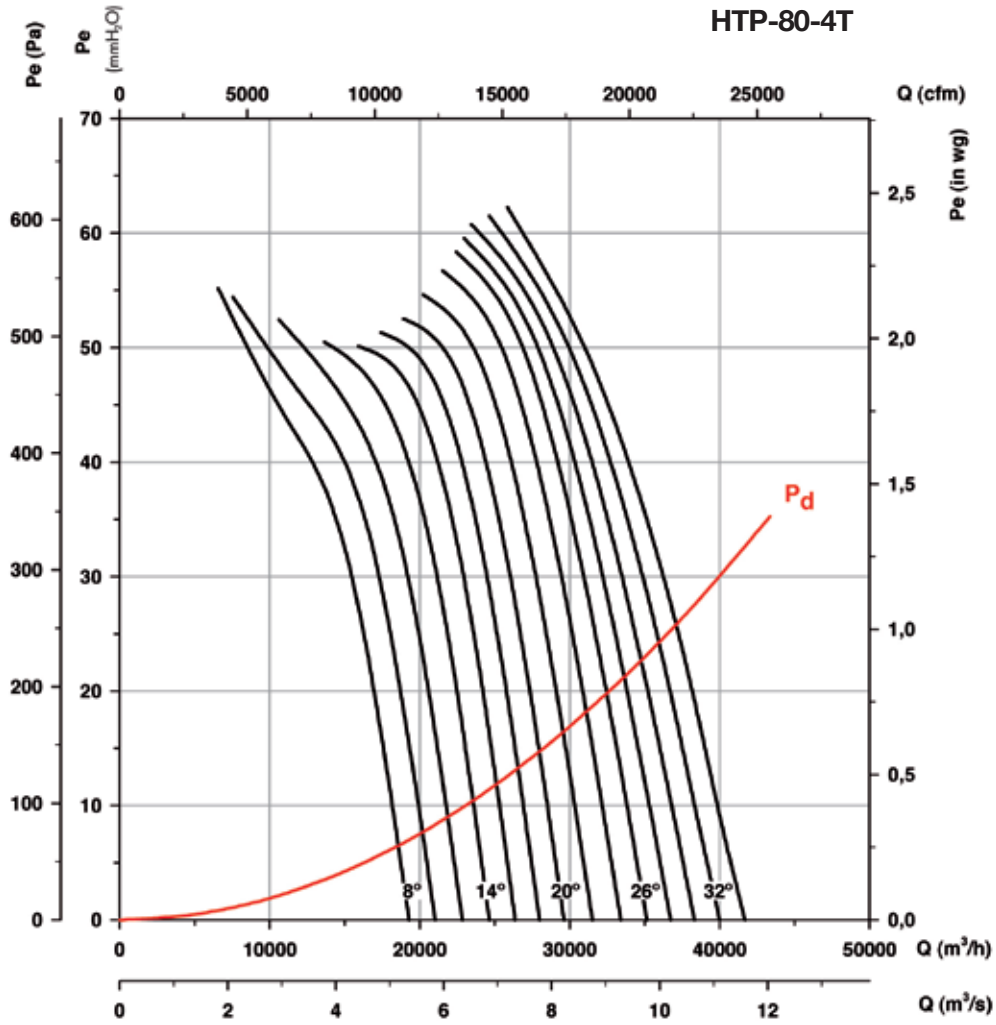

Absorbed power

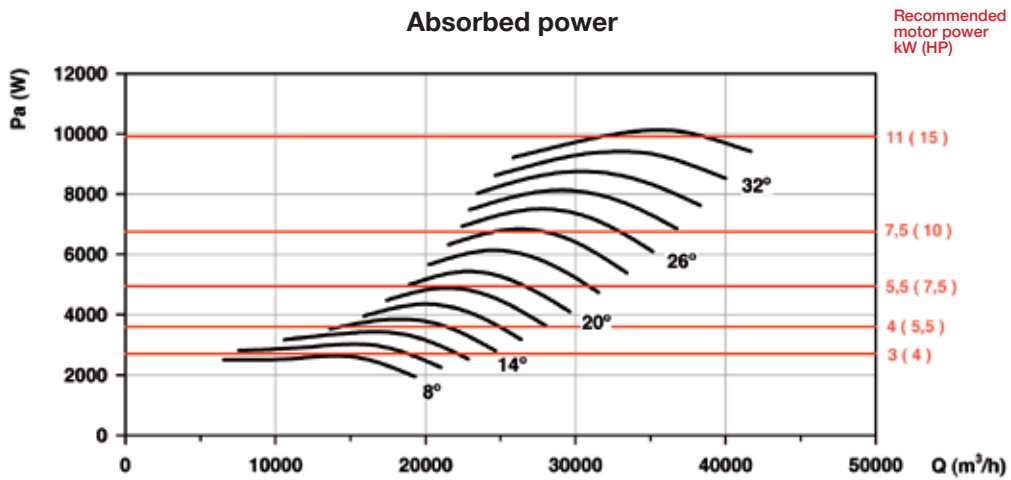

Recommended motor power kW (HP)



Available features best efficiency point (BEP) at the end of the series.

Characteristic Curves

Q = Airflow in m³/h, m³/s and cfm.

Pe = Static pressure in mmH₂O, Pa and inwg.

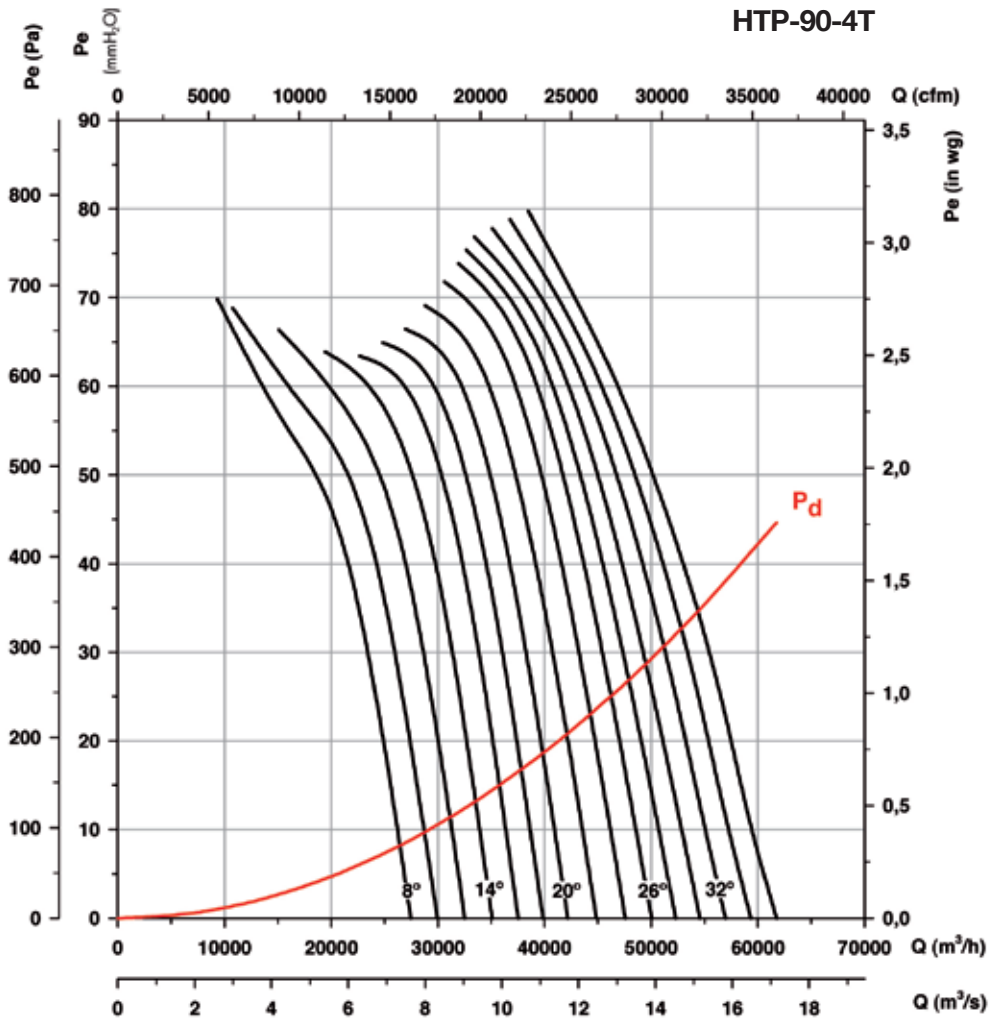

Absorbed power

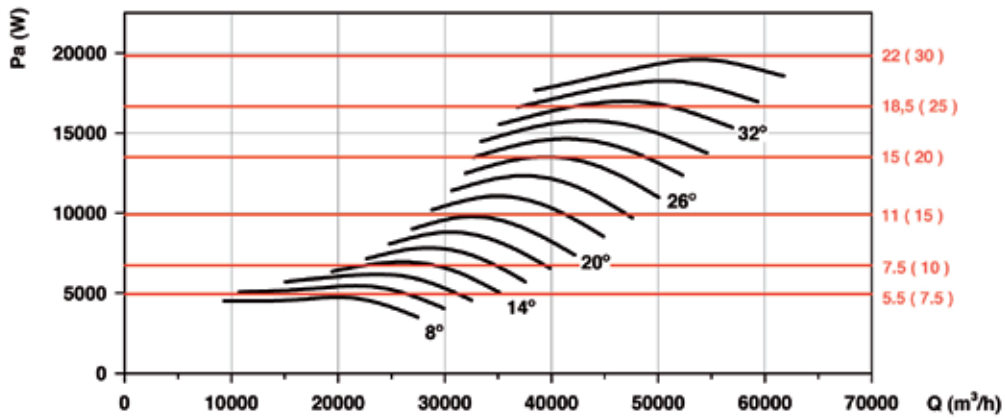

Recommended motor power kW (HP)



Available features best efficiency point (BEP) at the end of the series.

Characteristic Curves

Q = Airflow in m³/h, m³/s and cfm.

Pe = Static pressure in mmH₂O, Pa and inwg.

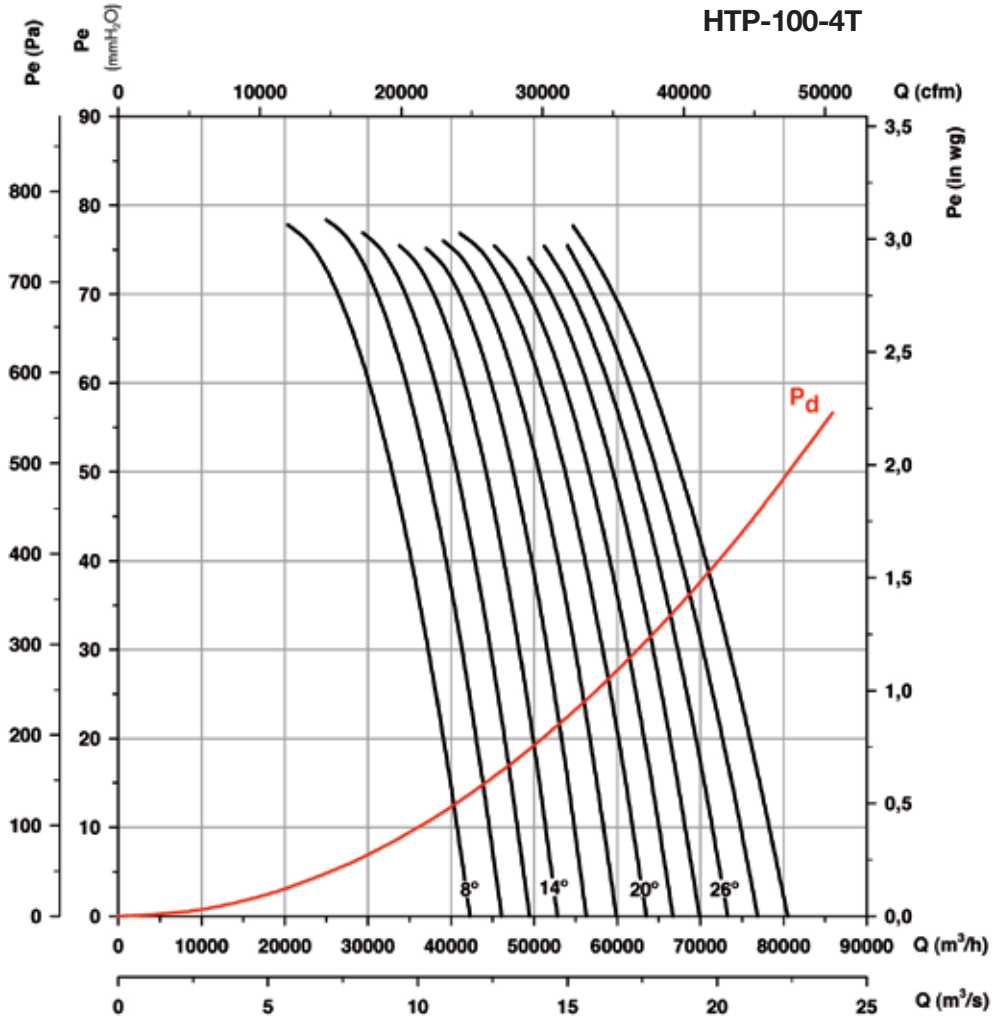

Absorbed power

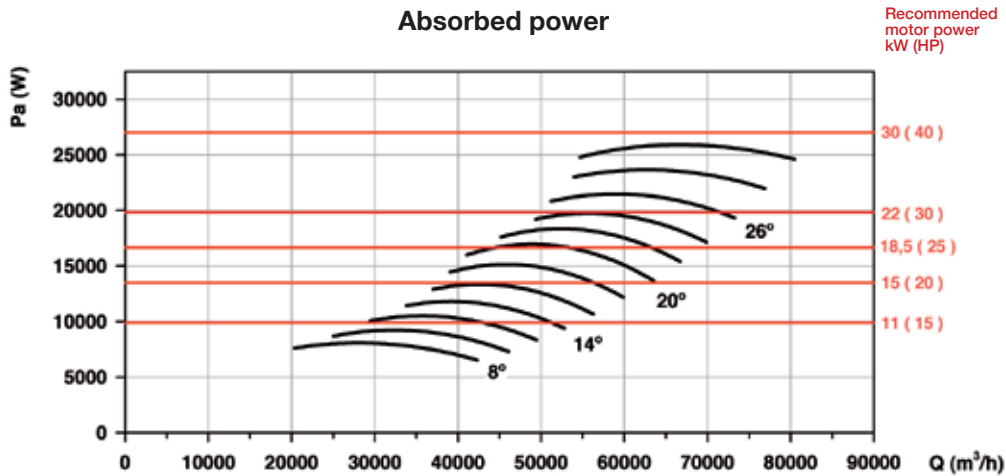

Available features best efficiency point (BEP) at the end of the series.

Characteristic Curves

Q = Airflow in m³/h, m³/s and cfm.

Pe = Static pressure in mmH₂O, Pa and inwg.

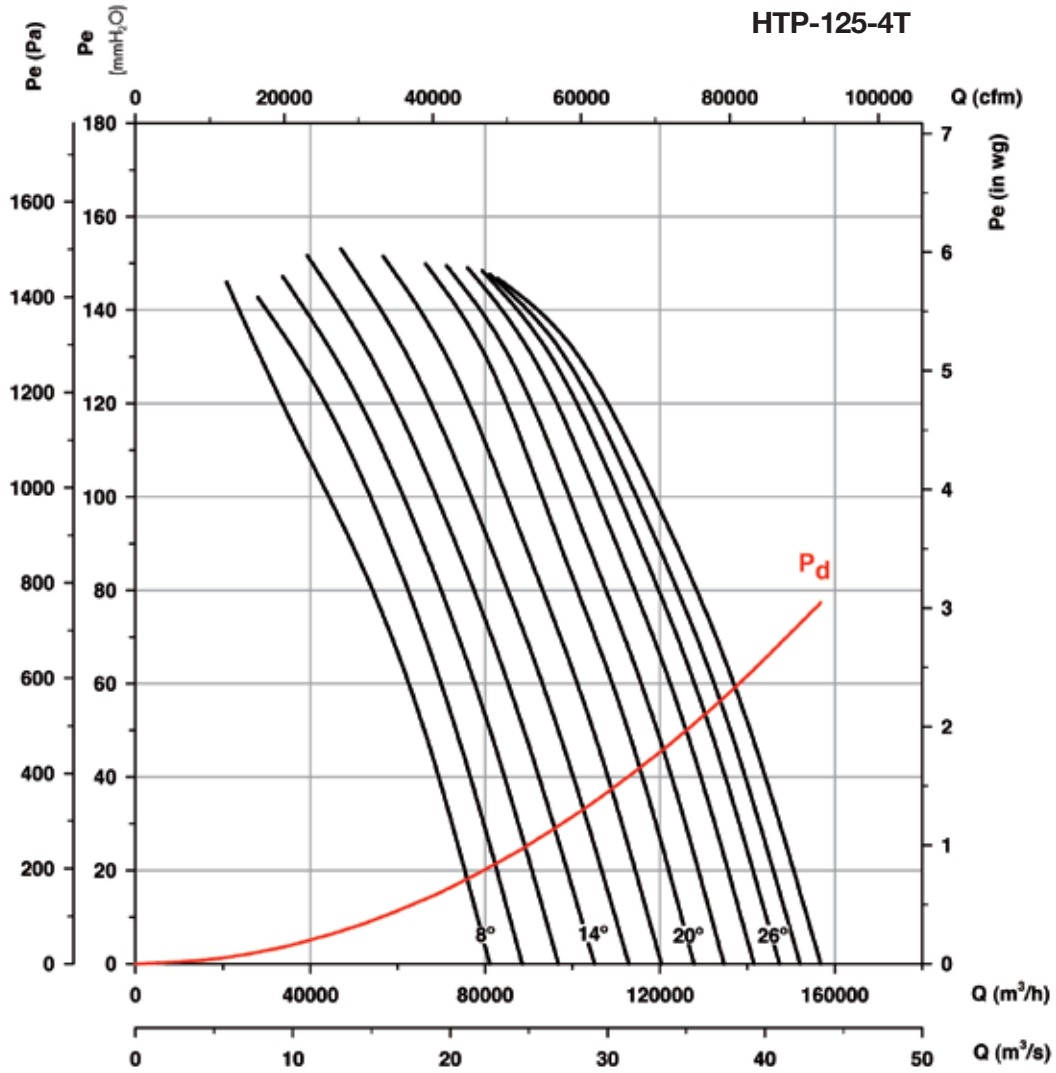

Absorbed power

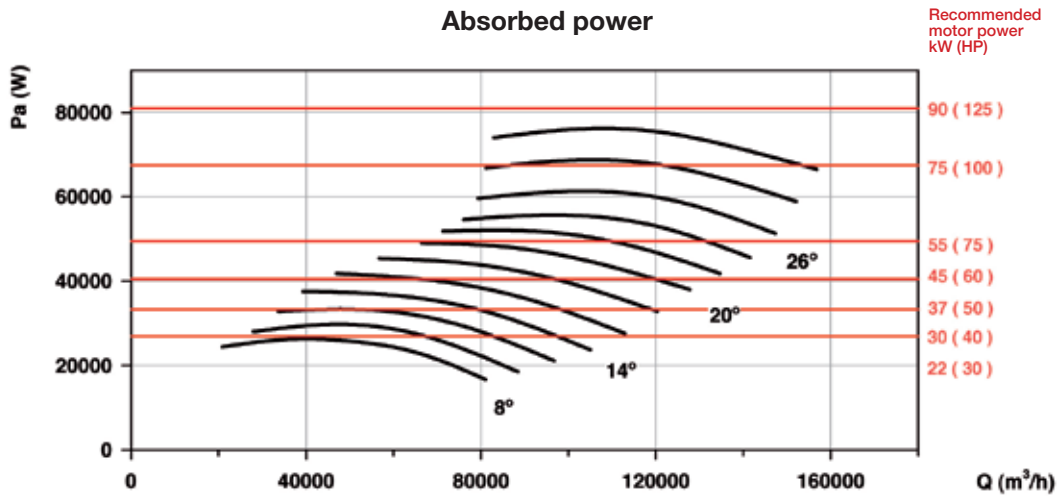

Available features best efficiency point (BEP) at the end of the series.



Erp. BEP (best efficiency point) characteristics

α [°]	Angle of inclination of the blades in degrees	SR	Specific relationship
PN	Motor's nominal power in kW	ηe [%]	Efficiency
MC	Measurement category	N	Degree of efficiency
EC	Efficiency category	[kW]	Electrical power
S	Static	[m³/h]	Airflow
T	Total	[mmH₂O]	Static or total pressure (According to EC)
VSD	Variable-speed drive	[RPM]	Speed

HTP-50-2T

α [°]	PN	MC	EC	VSD	SR	ηe [%]	N	[kW]	[m³/h]	[mmH ₂ O]	[RPM]
8	2.2	C	S	NO	1.00	40.3%	45.0	1.797	6731	39.48	2888
10	2.2	C	S	NO	1.00	39.0%	43.2	2.167	7180	43.23	2864
12	3	C	S	NO	1.01	38.3%	42.1	2.485	7884	44.29	2914
14	3	C	S	NO	1.01	37.3%	40.7	2.832	8541	45.39	2901

HTP-56-2T

α [°]	PN	MC	EC	VSD	SR	ηe [%]	N	[kW]	[m³/h]	[mmH ₂ O]	[RPM]
8	2.2	C	S	NO	1.00	60.5%	65.0	1.914	10060	42.26	2880
10	3	C	S	NO	1.01	54.8%	58.6	2.491	10410	48.18	2913
12	3	C	S	NO	1.01	50.9%	54.2	3.018	11389	49.56	2895
14	4	C	S	NO	1.01	49.1%	52.0	3.526	11508	55.31	2907
16	5.5	C	S	NO	1.01	48.1%	50.6	4.046	13418	53.26	2940
18	5.5	C	S	NO	1.01	45.8%	47.9	4.663	14275	54.95	2931
20	5.5	C	S	NO	1.01	44.5%	46.3	5.246	15266	56.14	2923
22	7.5	B	T	NO	1.01	62.3%	63.9	5.628	18179	70.82	2953
24	7.5	B	T	NO	1.01	61.7%	63.0	6.221	19341	72.87	2948
26	7.5	B	T	NO	1.01	61.5%	62.6	6.790	20914	73.33	2943
28	11	B	T	NO	1.01	58.3%	59.0	7.701	21588	76.35	2965

HTP-63-2T

α [°]	PN	MC	EC	VSD	SR	ηe [%]	N	[kW]	[m³/h]	[mmH ₂ O]	[RPM]
8	7.5	C	S	NO	1.01	64.5%	66.1	5.570	13562	97.33	2953
10	7.5	C	S	NO	1.01	63.1%	64.3	6.421	14654	101.55	2946
12	7.5	C	S	NO	1.01	62.2%	63.1	7.263	15642	106.10	2939
14	11	C	S	NO	1.01	63.0%	63.6	7.921	16570	110.56	2964
16	11	C	S	NO	1.01	62.3%	62.7	8.998	17063	120.77	2959
18	11	C	S	NO	1.01	60.7%	60.8	10.117	18242	123.71	2954
20	15	C	S	NO	1.01	60.8%	60.8	11.191	20352	122.82	2962
22	15	C	S	NO	1.02	59.8%	59.7	12.107	19247	138.18	2959
24	15	C	S	NO	1.02	59.1%	58.9	13.433	21081	138.33	2955
26	18.5	C	S	NO	1.02	58.4%	58.2	14.667	23032	136.65	2960
28	18.5	C	S	NO	1.02	55.8%	55.5	16.491	23740	142.38	2955
30	22	C	S	NO	1.02	53.5%	53.1	18.286	24546	146.29	2961
32	22	C	S	NO	1.02	51.6%	51.1	20.097	25369	150.12	2958

HTP-63-4T

α [°]	PN	MC	EC	VSD	SR	ηe [%]	N	[kW]	[m³/h]	[mmH ₂ O]	[RPM]
8	0.75	C	S	NO	1.00	56.9%	63.9	0.790	6781	24.33	1424
10	1.1	C	S	NO	1.00	57.0%	63.7	0.888	7327	25.39	1460
12	1.1	C	S	NO	1.00	56.2%	62.5	1.005	7821	26.53	1455
14	1.1	C	S	NO	1.00	55.8%	61.8	1.118	8285	27.64	1450
16	1.5	C	S	NO	1.00	56.1%	61.8	1.251	8532	30.19	1458
18	1.5	C	S	NO	1.00	54.6%	60.0	1.407	9121	30.93	1453
20	1.5	C	S	NO	1.00	54.3%	59.4	1.566	10176	30.70	1448
22	2.2	C	S	NO	1.00	54.4%	59.3	1.664	9623	34.55	1458
24	2.2	C	S	NO	1.00	53.7%	58.4	1.846	10541	34.58	1454
26	2.2	C	S	NO	1.00	52.8%	57.2	2.029	11516	34.16	1449
28	2.2	C	S	NO	1.00	50.4%	54.5	2.281	11870	35.60	1443
30	3	C	S	NO	1.00	48.9%	52.7	2.500	12273	36.57	1443
32	3	C	S	NO	1.00	47.2%	50.7	2.747	12685	37.53	1437
34	3	C	S	NO	1.00	43.9%	47.1	3.045	13549	36.21	1430
36	4	C	S	NO	1.00	41.3%	44.3	3.334	14297	35.38	1457
38	4	C	S	NO	1.00	38.2%	41.0	3.590	15407	32.71	1453



Erp. BEP (best efficiency point) characteristics

HTP-71-2T

α [°]	PN	MC	EC	VSD	SR	ηe [%]	N	[kW]	[m³/h]	[mmH₂O]	[RPM]
8	11	C	S	NO	1.01	67.3%	67.3	9.953	20358	120.78	2955
10	15	C	S	NO	1.01	66.2%	66.2	11.111	21567	125.28	2963
12	15	C	S	NO	1.01	65.0%	65.0	12.390	22971	128.86	2958
14	15	C	S	NO	1.01	64.7%	64.6	13.631	23869	135.83	2954
16	18.5	C	S	NO	1.02	63.7%	63.5	15.300	26171	136.80	2958
18	18.5	C	S	NO	1.02	62.5%	62.1	17.059	29550	132.46	2953
20	22	C	S	NO	1.02	63.9%	63.5	18.637	28934	151.17	2961
22	22	C	S	NO	1.02	61.8%	61.3	21.024	31510	151.41	2956
24	30	C	S	NO	1.02	58.8%	58.2	23.898	34832	148.18	2970
26	30	C	S	NO	1.02	57.6%	57.0	26.188	37324	148.58	2967
28	30	C	S	NO	1.02	56.9%	56.2	27.718	37671	153.78	2966
30	30	C	S	NO	1.02	55.1%	54.3	30.068	38513	157.94	2963

HTP-71-4T

α [°]	PN	MC	EC	VSD	SR	ηe [%]	N	[kW]	[m³/h]	[mmH₂O]	[RPM]
8	1.5	C	S	NO	1.00	60.5%	65.9	1.384	10179	30.19	1454
10	1.5	C	S	NO	1.00	59.1%	64.2	1.555	10783	31.32	1448
12	2.2	C	S	NO	1.00	59.1%	64.0	1.703	11486	32.22	1457
14	2.2	C	S	NO	1.00	58.9%	63.5	1.874	11935	33.96	1453
16	2.2	C	S	NO	1.00	57.6%	61.8	2.117	13085	34.20	1447
18	3	C	S	NO	1.00	57.2%	61.2	2.330	14775	33.11	1447
20	3	C	S	NO	1.00	58.4%	62.2	2.548	14467	37.79	1442
22	3	C	S	NO	1.00	56.5%	59.9	2.874	15755	37.85	1434
24	4	C	S	NO	1.00	54.1%	57.2	3.246	17416	37.04	1458
26	4	C	S	NO	1.00	53.0%	55.9	3.557	18662	37.15	1454
28	4	C	S	NO	1.00	52.4%	55.1	3.765	18836	38.44	1451
30	4	C	S	NO	1.00	50.7%	53.2	4.084	19256	39.49	1447
32	5.5	C	S	NO	1.01	50.6%	53.0	4.276	19555	40.65	1473
34	5.5	C	S	NO	1.01	48.4%	50.5	4.696	20811	40.15	1470
36	5.5	C	S	NO	1.01	45.9%	47.7	5.196	22143	39.56	1467
38	5.5	C	S	NO	1.01	44.0%	45.6	5.649	23383	39.07	1464

HTP-80-4T

α [°]	PN	MC	EC	VSD	SR	ηe [%]	N	[kW]	[m³/h]	[mmH₂O]	[RPM]
8	3	C	S	NO	1.00	45.9%	49.1	3.042	12859	39.86	1431
10	4	C	S	NO	1.00	46.8%	49.7	3.466	14380	41.40	1455
12	4	C	S	NO	1.00	47.5%	50.1	3.949	15604	44.16	1449
14	4	C	S	NO	1.01	49.1%	51.3	4.404	16927	46.89	1443
16	5.5	C	S	NO	1.01	50.3%	52.3	4.871	18604	48.40	1469
18	5.5	C	S	NO	1.01	49.3%	51.0	5.411	19531	50.19	1465
20	7.5	C	S	NO	1.01	50.1%	51.6	5.798	20646	51.65	1476
22	7.5	C	S	NO	1.01	48.8%	50.0	6.481	21619	53.75	1473
24	7.5	C	S	NO	1.01	48.1%	49.0	7.157	22603	55.93	1470
26	11	C	S	NO	1.01	47.5%	48.3	7.708	23377	57.56	1481
28	11	C	S	NO	1.01	45.9%	46.4	8.313	23934	58.57	1479
30	11	C	S	NO	1.01	44.6%	44.9	8.948	24700	59.31	1478
32	11	C	S	NO	1.01	43.8%	44.0	9.386	24657	61.26	1477
34	11	C	S	NO	1.01	43.4%	43.5	10.030	25847	61.88	1475



Erp. BEP (best efficiency point) characteristics

HTP-90-4T

α [°]	PN	MC	EC	VSD	SR	ηe [%]	N	[kW]	[m³/h]	[mmH₂O]	[RPM]
8	5.5	C	S	NO	1.01	47.2%	49.0	5.326	18308	50.44	1466
10	7.5	C	S	NO	1.01	48.9%	50.4	5.970	20475	52.40	1475
12	7.5	C	S	NO	1.01	49.7%	50.8	6.802	22217	55.88	1471
14	7.5	C	S	NO	1.01	51.3%	52.1	7.586	24102	59.35	1468
16	11	C	S	NO	1.01	52.4%	52.9	8.424	26488	61.25	1479
18	11	C	S	NO	1.01	51.4%	51.6	9.357	27809	63.53	1477
20	11	C	S	NO	1.01	50.7%	50.7	10.322	29396	65.37	1474
22	15	C	S	NO	1.01	49.8%	49.8	11.451	30782	68.03	1475
24	15	C	S	NO	1.01	49.0%	48.9	12.647	32182	70.79	1473
26	15	C	S	NO	1.01	47.9%	47.7	13.785	33285	72.85	1470
28	15	C	S	NO	1.01	46.3%	46.0	14.867	34077	74.13	1468
30	18.5	C	S	NO	1.01	45.1%	44.9	15.918	35169	75.07	1476
32	18.5	C	S	NO	1.01	44.4%	44.1	16.696	35107	77.54	1475
34	18.5	C	S	NO	1.01	44.0%	43.6	17.841	36802	78.32	1473
36	22	C	S	NO	1.01	44.0%	43.6	18.844	38497	79.11	1476

HTP-100-4T

α [°]	PN	MC	EC	VSD	SR	ηe [%]	N	[kW]	[m³/h]	[mmH₂O]	[RPM]
8	11	C	S	NO	1.01	57.7%	58.1	8.762	27276	68.06	1478
10	11	C	S	NO	1.01	59.3%	59.3	9.987	30265	71.90	1475
12	15	C	S	NO	1.01	58.3%	58.3	11.273	33345	72.39	1476
14	15	C	S	NO	1.01	57.0%	56.9	12.676	37128	71.54	1473
16	15	C	S	NO	1.01	54.7%	54.5	14.268	39472	72.67	1469
18	18.5	C	S	NO	1.01	52.3%	52.0	15.886	41007	74.43	1476
20	18.5	C	S	NO	1.01	50.1%	49.8	17.614	42917	75.60	1474
22	22	C	S	NO	1.01	49.5%	49.1	18.804	45347	75.35	1476
24	22	C	S	NO	1.01	48.6%	48.1	20.483	49344	74.08	1474
26	30	C	S	NO	1.01	47.6%	47.0	22.122	51228	75.43	1486
28	30	C	S	NO	1.01	45.4%	44.8	24.441	54000	75.47	1485
30	30	C	S	NO	1.01	44.0%	43.3	26.349	54700	77.79	1484

HTP-125-4T

α [°]	PN	MC	EC	VSD	SR	ηe [%]	N	[kW]	[m³/h]	[mmH₂O]	[RPM]
8	30	C	S	NO	1.01	44.0%	43.3	27.375	50255	88.10	1483
10	37	C	S	NO	1.01	47.0%	46.2	31.153	53478	100.67	1484
12	37	C	S	NO	1.01	49.1%	48.2	34.444	58117	106.95	1483
14	45	C	S	NO	1.01	51.4%	50.5	37.559	62762	113.08	1480
16	45	C	S	NO	1.01	52.9%	51.9	41.397	69294	116.17	1478
18	55	C	S	NO	1.01	54.2%	53.1	45.643	76423	118.93	1484
20	55	C	S	NO	1.01	55.2%	54.1	50.157	83496	121.90	1483
22	75	C	S	NO	1.01	55.2%	53.9	54.468	83497	132.17	1490
24	75	C	S	NO	1.02	55.3%	54.0	57.842	85592	137.26	1489
26	75	C	S	NO	1.02	52.7%	51.3	63.469	89569	137.11	1488
28	75	C	S	NO	1.02	48.3%	46.9	71.440	94123	134.68	1486
30	90	C	S	NO	1.02	45.0%	43.5	79.160	98798	132.55	1487

Accessories

See accessories section.



INT

AR

VSD3/A-RFT
VSD1/A-RFM

CUADROS

PL

P

PT/H

RT

BTUB

BAC

PS

S

SI

PV

HGT HGTX

HGT: Large diameter long cased axial fans with direct drive motor

HGTX: Large diameter long cased axial fans with external motor

Long cased axial fans, supplied with 3, 6 or 9 blade aluminium impellers with different slope angles.



HGT



HGTX

Fan:

- Airflow direction from motor to impeller
- Impellers made from cast aluminium supplied with 3, 6 or 9 blades with adjustable slope angles.
- Sheet steel cased casing
- HGT: The standard version is short casing. The long-casing version is equipped with an inspection hatch.
- HGTX: Standard version in long casing, equipped with an inspection hatch.

Motor:

- IE3 efficiency motors for capacities equal to or over 7.5kW, except single-phase, 2 speed and 8 pole motors
- IE2 efficiency motors for capacities equal to or over 0.75kW and below 7.5kW, except single-phase, 2 speed and 8 pole motors.
- Class F motors, with ball bearings, IP55 protection
- Three-phase 230/400V-50Hz. (up to 4kW) and 400/690V-50Hz. (power over 4kW)
- Fan working temperature:
HGT: -25°C +50°C
HGTX: -25°C +120°C

Finish:

- Anticorrosive finish in polyester resin polymerised at 190°C, after degreasing with phosphate-free nanotechnology treatment.

On request:

- Airflow direction from impeller to motor.
- 100% reversible impellers.
- Special windings for different voltages.
- ATEX certification, Category 2
- HGT: Long-casing fans with inspection hatch
- Two-speed motors
- IE2 and IE3 efficiency motors for any power

Order code



HGT: Large diameter long cased axial fans with direct drive motor
HGTX: Large diameter long cased axial fans with external motor

Impeller diameter in cm.

Number of motor poles
4=1400 r/min. 50 Hz
6=900 r/min. 50 Hz
8=750 r/min. 50 Hz

T=Three-phase

Number of blades:
3 blades
6 blades
9 blades

Motor power (HP)

Angle of inclination of the blades

PV=Distributor



Technical characteristics

Model	Speed (r/min)	Max. current admissible (A)			Installed capacity (kW)	Maximum airflow (m³/h)	Sound pressure level dB(A)	Approx. weight (Kg)		
		230V	400V	690V				HGT Long	HGTX Short	
HGT-125-4T/3-10 IE3	HGTX-125-4T/3-10 IE3	1465	13.90	8.06	7.50	58150	88	227	194	358
HGT-125-4T/3-15 IE3	HGTX-125-4T/3-15 IE3	1470	20.90	12.10	11.00	77450	89	274	246	394
HGT-125-4T/3-20 IE3	HGTX-125-4T/3-20 IE3	1465	27.90	16.20	15.00	91400	91	285	257	405
HGT-125-4T/3-25 IE3	HGTX-125-4T/3-25 IE3	1470	35.10	20.30	18.50	98350	91	363	320	450
HGT-125-4T/3-30 IE3	HGTX-125-4T/3-30 IE3	1470	41.00	23.80	22.00	110500	92	363	320	450
HGT-125-4T/3-40 IE3	HGTX-125-4T/3-40 IE3	1480	57.10	33.10	30.00	120850	93	468	425	557
HGT-125-4T/3-50 IE3	HGTX-125-4T/3-50 IE3	1480	69.20	40.10	37.00	129000	94	551	495	622
HGT-125-4T/3-60 IE3	HGTX-125-4T/3-60 IE3	1475	80.90	46.90	45.00	140000	95	589	533	660
HGT-125-4T/6-20 IE3	HGTX-125-4T/6-20 IE3	1465	27.90	16.20	15.00	78300	89	294	266	414
HGT-125-4T/6-25 IE3	HGTX-125-4T/6-25 IE3	1470	35.10	20.30	18.50	92000	90	372	329	459
HGT-125-4T/6-30 IE3	HGTX-125-4T/6-30 IE3	1470	41.00	23.80	22.00	98100	90	372	329	459
HGT-125-4T/6-40 IE3	HGTX-125-4T/6-40 IE3	1480	57.10	33.10	30.00	117000	92	477	433	566
HGT-125-4T/6-50 IE3	HGTX-125-4T/6-50 IE3	1480	69.20	40.10	37.00	123700	93	560	504	631
HGT-125-4T/6-60 IE3	HGTX-125-4T/6-60 IE3	1475	80.90	46.90	45.00	136000	94	598	542	669
HGT-125-4T/6-75 IE3	HGTX-125-4T/6-75 IE3	1480	98.60	57.20	55.00	148000	95	614	564	700
HGT-125-4T/6-100 IE3	HGTX-125-4T/6-100 IE3	1485	134.00	77.70	75.00	161000	96	708	658	794
HGT-125-4T/9-25 IE3	HGTX-125-4T/9-25 IE3	1470	35.10	20.30	18.50	79750	88	381	338	468

Technical characteristics

Model	Speed (r/min)	Max. current admissible (A)			Installed capacity (kW)	Maximum airflow (m³/h)	Sound pres- sure level dB(A)	Approx. weight (Kg)		
		230V	400V	690V				HGT Long	HGT Short	HGTX
HGT-125-4T/9-30 IE3	HGTX-125-4T/9-30 IE3	1470	41.00	23.80	22.00	97000	89	381	338	468
HGT-125-4T/9-40 IE3	HGTX-125-4T/9-40 IE3	1480	57.10	33.10	30.00	111200	91	486	442	575
HGT-125-4T/9-50 IE3	HGTX-125-4T/9-50 IE3	1480	69.20	40.10	37.00	118350	93	569	513	640
HGT-125-4T/9-60 IE3	HGTX-125-4T/9-60 IE3	1475	80.90	46.90	45.00	127000	94	607	551	678
HGT-125-4T/9-75 IE3	HGTX-125-4T/9-75 IE3	1480	98.60	57.20	55.00	142000	95	623	573	709
HGT-125-4T/9-100 IE3	HGTX-125-4T/9-100 IE3	1485	134.00	77.70	75.00	155000	99	717	667	803
HGT-125-6T/3-4	HGTX-125-6T/3-4	960	12.70	7.33	3.00	46550	79	204	171	335
HGT-125-6T/3-5.5	HGTX-125-6T/3-5.5	960	16.50	9.53	4.00	55300	80	209	176	340
HGT-125-6T/3-7.5	HGTX-125-6T/3-7.5	975	11.50	6.64	5.50	64450	81	217	184	348
HGT-125-6T/3-10 IE3	HGTX-125-6T/3-10 IE3	975	14.80	8.58	7.50	76400	83	297	269	417
HGT-125-6T/3-15 IE3	HGTX-125-6T/3-15 IE3	975	21.90	12.70	11.00	87050	84	298	270	418
HGT-125-6T/3-20 IE3	HGTX-125-6T/3-20 IE3	975	28.20	16.30	15.00	91700	85	407	364	494
HGT-125-6T/6-5.5	HGTX-125-6T/6-5.5	960	16.50	9.53	4.00	51300	77	218	185	349
HGT-125-6T/6-7.5	HGTX-125-6T/6-7.5	975	11.50	6.64	5.50	60300	77	226	193	357
HGT-125-6T/6-10 IE3	HGTX-125-6T/6-10 IE3	975	14.80	8.58	7.50	72250	79	306	278	426
HGT-125-6T/6-15 IE3	HGTX-125-6T/6-15 IE3	975	21.90	12.70	11.00	85450	81	307	279	427
HGT-125-6T/6-20 IE3	HGTX-125-6T/6-20 IE3	975	28.20	16.30	15.00	92850	82	416	373	503
HGT-125-6T/6-25 IE3	HGTX-125-6T/6-25 IE3	980	35.90	20.80	18.50	103000	84	449	405	538
HGT-125-6T/9-10 IE3	HGTX-125-6T/9-10 IE3	975	14.80	8.58	7.50	68200	78	315	287	435
HGT-125-6T/9-15 IE3	HGTX-125-6T/9-15 IE3	975	21.90	12.70	11.00	77550	81	316	288	436
HGT-125-6T/9-20 IE3	HGTX-125-6T/9-20 IE3	975	28.20	16.30	15.00	92900	84	425	382	512
HGT-125-6T/9-25 IE3	HGTX-125-6T/9-25 IE3	980	35.90	20.80	18.50	98700	85	458	414	547
HGT-125-6T/9-30 IE3	HGTX-125-6T/9-30 IE3	980	42.40	24.60	22.00	104000	87	463	419	552
HGT-125-8T/3-3	HGTX-125-8T/3-3	705	9.53	5.50	2.20	48800	71	209	176	340
HGT-125-8T/3-4	HGTX-125-8T/3-4	705	12.82	7.40	3.00	54900	71	216	183	347
HGT-125-8T/3-5.5	HGTX-125-8T/3-5.5	710	16.11	9.30	4.00	62100	73	249	221	369
HGT-125-8T/3-7.5	HGTX-125-8T/3-7.5	725	12.70	7.33	5.50	69500	75	262	234	382
HGT-125-8T/6-3	HGTX-125-8T/6-3	705	9.53	5.50	2.20	45700	69	218	185	349
HGT-125-8T/6-4	HGTX-125-8T/6-4	705	12.82	7.40	3.00	51800	71	225	192	356
HGT-125-8T/6-5.5	HGTX-125-8T/6-5.5	710	16.11	9.30	4.00	61500	72	258	230	378
HGT-125-8T/6-7.5	HGTX-125-8T/6-7.5	725	12.70	7.33	5.50	67500	73	271	243	391
HGT-125-8T/6-10	HGTX-125-8T/6-10	725	17.00	9.81	7.50	75500	75	301	273	421
HGT-125-8T/9-4	HGTX-125-8T/9-4	705	12.82	7.40	3.00	48200	70	234	201	365
HGT-125-8T/9-5.5	HGTX-125-8T/9-5.5	710	16.11	9.30	4.00	55200	73	267	239	387
HGT-125-8T/9-7.5	HGTX-125-8T/9-7.5	725	12.70	7.33	5.50	67000	75	280	252	400
HGT-125-8T/9-10	HGTX-125-8T/9-10	725	17.00	9.81	7.50	74750	76	310	282	430
HGT-125-8T/9-15	HGTX-125-8T/9-15	725	21.70	12.53	11.00	80800	79	372	329	459
HGT-140-6T/3-4		960	12.70	7.33	3.00	51000	82	251	214	
HGT-140-6T/3-5.5		960	16.50	9.53	4.00	56700	83	258	221	
HGT-140-6T/3-7.5		975	11.50	6.64	5.50	67900	84	266	229	
HGT-140-6T/3-10 IE3		975	14.80	8.58	7.50	80100	85	355	316	
HGT-140-6T/3-15 IE3		975	21.90	12.70	11.00	96900	86	356	317	
HGT-140-6T/3-20 IE3		975	28.20	16.30	15.00	106000	88	463	413	
HGT-140-6T/6-5.5		960	16.50	9.53	4.00	58000	82	268	231	
HGT-140-6T/6-7.5		975	11.50	6.64	5.50	66000	84	276	239	
HGT-140-6T/6-10 IE3		975	14.80	8.58	7.50	80700	85	365	326	
HGT-140-6T/6-15 IE3		975	21.90	12.70	11.00	96700	86	366	327	
HGT-140-6T/6-20 IE3		975	28.20	16.30	15.00	104000	87	472	423	
HGT-140-6T/6-25 IE3		980	35.90	20.80	18.50	115000	88	506	457	
HGT-140-6T/6-30 IE3		980	42.40	24.60	22.00	119000	89	511	462	
HGT-140-6T/9-10 IE3		975	14.80	8.58	7.50	70000	84	374	335	
HGT-140-6T/9-15 IE3		975	21.90	12.70	11.00	86000	86	375	336	
HGT-140-6T/9-20 IE3		975	28.20	16.30	15.00	97500	87	482	432	
HGT-140-6T/9-25 IE3		980	35.90	20.80	18.50	111000	88	515	467	
HGT-140-6T/9-30 IE3		980	42.40	24.60	22.00	118500	89	520	472	
HGT-140-6T/9-40 IE3		985	55.40	32.10	30.00	132000	91	676	614	
HGT-140-6T/9-50 IE3		985	67.20	39.00	37.00	139000	92	693	638	
HGT-140-8T/3-3		705	9.53	5.50	2.20	50000	78	258	221	
HGT-140-8T/3-4		705	12.82	7.40	3.00	57000	78	265	228	
HGT-140-8T/3-5.5		710	16.11	9.30	4.00	65400	79	307	268	
HGT-140-8T/3-7.5		725	12.70	7.33	5.50	77500	81	320	281	
HGT-140-8T/3-10		725	17.00	9.81	7.50	86000	82	350	311	
HGT-140-8T/6-3		705	9.53	5.50	2.20	47500	78	268	231	
HGT-140-8T/6-4		705	12.82	7.40	3.00	57600	79	275	238	

Technical characteristics

Model	Speed (r/min)	Max. current admissible (A)			Installed capacity (kW)	Maximum airflow (m³/h)	Sound pres- sure level dB(A)	Approx. weight (Kg)		
		230V	400V	690V				HGT		HGTX
								Long	Short	
HGT-140-8T/6-5.5	710	16.11	9.30		4.00	65200	80	317	278	
HGT-140-8T/6-7.5	725		12.70	7.33	5.50	73300	81	330	291	
HGT-140-8T/6-10	725		17.00	9.81	7.50	82200	82	360	321	
HGT-140-8T/6-15	725		21.70	12.53	11.00	94200	83	419	370	
HGT-140-8T/9-4	705	12.82	7.40		3.00	47200	79	284	247	
HGT-140-8T/9-5.5	710	16.11	9.30		4.00	64400	79	326	287	
HGT-140-8T/9-7.5	725		12.70	7.33	5.50	69200	81	339	300	
HGT-140-8T/9-10	725		17.00	9.81	7.50	78700	82	369	330	
HGT-140-8T/9-15	725		21.70	12.53	11.00	94300	83	429	379	
HGT-140-8T/9-20	725		31.70	18.30	15.00	103000	86	485	437	
HGT-160-6T/3-5.5	960	16.50	9.53		4.00	66000	81	327	275	
HGT-160-6T/3-7.5	975		11.50	6.64	5.50	76100	82	335	283	
HGT-160-6T/3-10 IE3	975		14.80	8.58	7.50	84000	83	428	374	
HGT-160-6T/3-15 IE3	975		21.90	12.70	11.00	102000	85	429	375	
HGT-160-6T/3-20 IE3	975		28.20	16.30	15.00	127000	86	549	480	
HGT-160-6T/3-25 IE3	980		35.90	20.80	18.50	136700	87	583	513	
HGT-160-6T/3-30 IE3	980		42.40	24.60	22.00	145000	89	588	518	
HGT-160-6T/6-10 IE3	975		14.80	8.58	7.50	75000	83	439	385	
HGT-160-6T/6-15 IE3	975		21.90	12.70	11.00	93500	85	440	386	
HGT-160-6T/6-20 IE3	975		28.20	16.30	15.00	120500	86	559	490	
HGT-160-6T/6-25 IE3	980		35.90	20.80	18.50	130000	87	593	524	
HGT-160-6T/6-30 IE3	980		42.40	24.60	22.00	140000	88	598	529	
HGT-160-6T/6-40 IE3	985		55.40	32.10	30.00	158000	89	771	672	
HGT-160-6T/6-50 IE3	985		67.20	39.00	37.00	171000	91	784	699	
HGT-160-6T/9-15 IE3	975		21.90	12.70	11.00	87000	85	450	396	
HGT-160-6T/9-20 IE3	975		28.20	16.30	15.00	104000	86	569	500	
HGT-160-6T/9-25 IE3	980		35.90	20.80	18.50	127000	87	603	534	
HGT-160-6T/9-30 IE3	980		42.40	24.60	22.00	135000	88	608	539	
HGT-160-6T/9-40 IE3	985		55.40	32.10	30.00	147000	89	781	682	
HGT-160-6T/9-50 IE3	985		67.20	39.00	37.00	165000	90	794	710	
HGT-160-6T/9-60 IE3	985		84.40	48.90	45.00	177000	91	1019	920	
HGT-160-6T/9-75 IE3	985		103.00	59.70	55.00	193000	92	1077	978	
HGT-160-6T/9-100 IE3	990		139.00	80.60	75.00	207500	93	1232	1133	
HGT-160-8T/3-3	705	9.53	5.50		2.20	54000	76	327	275	
HGT-160-8T/3-4	705	12.82	7.40		3.00	57500	77	334	282	
HGT-160-8T/3-5.5	710	16.11	9.30		4.00	74000	79	380	326	
HGT-160-8T/3-7.5	725		12.70	7.33	5.50	83500	80	393	339	
HGT-160-8T/3-10	725		17.00	9.81	7.50	97500	81	423	369	
HGT-160-8T/3-15	725		21.70	12.53	11.00	115000	83	496	427	
HGT-160-8T/6-4	705	12.82	7.40		3.00	70900	76	344	292	
HGT-160-8T/6-5.5	710	16.11	9.30		4.00	84500	77	391	337	
HGT-160-8T/6-7.5	725		12.70	7.33	5.50	77000	79	404	350	
HGT-160-8T/6-10	725		17.00	9.81	7.50	95000	80	434	380	
HGT-160-8T/6-15	725		21.70	12.53	11.00	109000	82	506	437	
HGT-160-8T/6-20	725		31.70	18.30	15.00	123000	83	563	494	
HGT-160-8T/6-25	725		35.85	20.70	18.50	130000	84	641	542	
HGT-160-8T/9-7.5	725		12.70	7.33	5.50	70000	79	414	360	
HGT-160-8T/9-10	725		17.00	9.81	7.50	87000	80	444	390	
HGT-160-8T/9-15	725		21.70	12.53	11.00	103000	82	516	447	
HGT-160-8T/9-20	725		31.70	18.30	15.00	117000	83	573	504	
HGT-160-8T/9-25	725		35.85	20.70	18.50	133000	84	651	552	
HGT-160-8T/9-30	725		41.60	24.02	22.00	140000	85	666	567	
HGT-160-8T/9-40	730		60.79	35.10	30.00	151000	86	724	640	

Acoustic features

The specified values are determined according to free field measurements of pressure and sound levels in dB(A) at an equivalent distance of twice the fan's span plus the impeller's diameter, with a minimum of 1.5 m.

Sound power Lw(A) spectrum in dB(A) via frequency band in Hz.

Model	63	125	250	500	1000	2000	4000	8000	Model	63	125	250	500	1000	2000	4000	8000
125-4T/3-10	70	76	88	98	98	94	86	82	140-6T/9-10	66	84	93	92	91	87	78	73
125-4T/3-15	71	77	89	99	99	95	87	83	140-6T/9-15	67	85	94	93	92	88	79	74
125-4T/3-20	72	78	90	100	100	96	88	84	140-6T/9-20	69	87	96	95	94	90	81	76
125-4T/3-25	73	79	91	101	101	97	89	85	140-6T/9-25	70	88	97	96	95	91	82	77
125-4T/3-30	74	80	92	102	102	98	90	86	140-6T/9-30	70	88	97	96	95	91	82	77
125-4T/3-40	75	81	93	103	103	99	91	87	140-6T/9-40	71	89	98	97	96	92	83	78
125-4T/3-50	76	82	94	104	104	100	92	88	140-6T/9-50	74	92	101	100	99	95	86	81
125-4T/3-60	77	83	95	105	105	101	93	89	140-8T/3-3	60	70	78	83	82	81	68	63
125-4T/6-20	66	74	90	97	99	94	88	84	140-8T/3-4	64	74	82	87	86	85	72	67
125-4T/6-25	67	75	91	98	100	95	89	85	140-8T/3-5.5	65	75	83	88	87	86	73	68
125-4T/6-30	68	76	92	99	101	96	90	86	140-8T/3-7.5	66	76	84	89	88	87	74	69
125-4T/6-40	69	77	93	100	102	97	91	87	140-8T/3-10	68	78	86	91	90	89	76	71
125-4T/6-50	71	79	95	102	104	99	93	89	140-8T/6-3	61	73	82	86	84	78	68	65
125-4T/6-60	72	80	96	103	105	100	94	90	140-8T/6-4	63	75	84	88	86	80	70	67
125-4T/6-75	72	80	96	103	105	100	94	90	140-8T/6-5.5	64	76	85	89	87	81	71	68
125-4T/6-100	74	82	98	105	107	102	96	92	140-8T/6-7.5	65	77	86	90	88	82	72	69
125-4T/9-25	66	74	91	97	98	93	88	84	140-8T/6-10	66	78	87	91	89	83	73	70
125-4T/9-30	67	75	92	98	99	94	89	85	140-8T/6-15	68	80	89	93	91	85	75	72
125-4T/9-40	68	76	93	99	100	95	90	86	140-8T/9-4	61	72	83	88	86	82	72	67
125-4T/9-50	70	78	95	101	102	97	92	88	140-8T/9-5.5	62	73	84	89	87	83	73	68
125-4T/9-60	72	80	97	103	104	99	94	90	140-8T/9-7.5	63	74	85	90	88	84	74	69
125-4T/9-75	72	80	97	103	104	99	94	90	140-8T/9-10	64	75	86	91	89	85	75	70
125-4T/9-100	74	82	99	105	106	101	96	92	140-8T/9-15	65	76	87	92	90	86	76	71
125-6T/3-4	64	72	84	88	86	81	72	68	140-8T/9-20	67	78	89	94	92	88	78	73
125-6T/3-5.5	66	74	86	90	88	83	74	70	160-6T/3-5.5	67	77	85	90	89	88	75	70
125-6T/3-7.5	67	75	87	91	89	84	75	71	160-6T/3-7.5	68	78	86	91	90	89	76	71
125-6T/3-10	68	76	88	92	90	85	76	72	160-6T/3-10	69	79	87	92	91	90	77	72
125-6T/3-15	69	77	89	93	91	86	77	73	160-6T/3-15	70	80	88	93	92	91	78	73
125-6T/3-20	71	79	91	95	93	88	79	75	160-6T/3-20	72	82	90	95	94	93	80	75
125-6T/6-5.5	59	68	81	84	85	82	71	67	160-6T/3-25	73	83	91	96	95	94	81	76
125-6T/6-7.5	60	69	82	85	86	83	72	68	160-6T/3-30	74	84	92	97	96	95	82	77
125-6T/6-10	61	70	83	86	87	84	73	69	160-6T/6-10	67	82	91	93	90	84	76	72
125-6T/6-15	63	72	85	88	89	86	75	71	160-6T/6-15	68	83	92	94	91	85	77	73
125-6T/6-20	65	74	87	90	91	88	77	73	160-6T/6-20	70	85	94	96	93	87	79	75
125-6T/6-25	66	75	88	91	92	89	78	74	160-6T/6-25	71	86	95	97	94	88	80	76
125-6T/9-10	57	67	82	86	85	84	73	69	160-6T/6-30	71	86	95	97	94	88	80	76
125-6T/9-15	59	69	84	88	87	86	75	71	160-6T/6-40	72	87	96	98	95	89	81	77
125-6T/9-20	62	72	87	91	90	89	78	74	160-6T/6-50	74	89	98	100	97	91	83	79
125-6T/9-25	64	74	89	93	92	91	80	76	160-6T/9-15	67	85	94	93	92	88	79	74
125-6T/9-30	66	76	91	95	94	93	82	78	160-6T/9-20	68	86	95	94	93	89	80	75
125-8T/3-3	56	63	74	78	77	70	61	57	160-6T/9-25	69	87	96	95	94	90	81	76
125-8T/3-4	59	66	77	81	80	73	64	60	160-6T/9-30	70	88	97	96	95	91	82	77
125-8T/3-5.5	60	67	78	82	81	74	65	61	160-6T/9-40	71	89	98	97	96	92	83	78
125-8T/3-7.5	62	69	80	84	83	76	67	63	160-6T/9-50	72	90	99	98	97	93	84	79
125-8T/6-3	53	61	73	78	77	72	61	57	160-6T/9-60	72	90	99	98	97	93	84	79
125-8T/6-4	54	62	74	79	78	73	62	58	160-6T/9-75	73	91	100	99	98	94	85	80
125-8T/6-5.5	56	64	76	81	80	75	64	60	160-6T/9-100	75	93	102	101	100	96	87	82
125-8T/6-7.5	58	66	78	83	82	77	66	62	160-8T/3-3	61	71	79	84	83	82	69	64
125-8T/6-10	59	67	79	84	83	78	67	63	160-8T/3-4	63	73	81	86	85	84	71	66
125-8T/9-4	51	62	72	78	79	74	63	59	160-8T/3-5.5	64	74	82	87	86	85	72	67
125-8T/9-5.5	53	64	74	80	81	76	65	61	160-8T/3-7.5	65	75	83	88	87	86	73	68
125-8T/9-7.5	56	67	77	83	84	79	68	64	160-8T/3-10	66	76	84	89	88	87	74	69
125-8T/9-10	58	69	79	85	86	81	70	66	160-8T/3-15	68	78	86	91	90	89	76	71
125-8T/9-15	59	70	80	86	87	82	71	67	160-8T/6-4	60	75	84	86	83	77	69	65
140-6T/3-4	66	76	84	89	88	87	74	74	160-8T/6-5.5	61	76	85	87	84	78	70	66
140-6T/3-5.5	69	79	87	92	91	90	77	77	160-8T/6-7.5	62	77	86	88	85	79	71	67
140-6T/3-7.5	69	79	87	92	91	90	77	77	160-8T/6-10	63	78	87	89	86	80	72	68
140-6T/3-10	70	80	88	93	92	91	78	78	160-8T/6-15	65	80	89	91	88	82	74	70
140-6T/3-15	71	81	89	94	93	92	79	79	160-8T/6-20	66	81	90	92	89	83	75	71
140-6T/3-20	73	83	91	96	95	94	81	81	160-8T/6-25	68	83	92	94	91	85	77	73
140-6T/6-5.5	66	81	90	92	89	83	75	71	160-8T/9-7.5	60	78	87	86	85	81	72	67
140-6T/6-7.5	67	82	91	93	90	84	76	72	160-8T/9-10	62	80	89	88	87	83	74	69
140-6T/6-10	68	83	92	94	91	85	77	73	160-8T/9-15	63	81	90	89	88	84	75	70
140-6T/6-15	69	84	93	95	92	86	78	74	160-8T/9-20	64	82	91	90	89	85	76	71
140-6T/6-20	71	86	95	97	94	88	80	76	160-8T/9-25	65	83	92	91	90	86	77	72
140-6T/6-25	72	87	96	98	95	89	81	77	160-8T/9-30	66	84	93	92	91	87	78	73
140-6T/6-30	73	88	97	99	96	90	82	78	160-8T/9-40	68	86	95	94	93	89	80	75

Dimensions in mm

HGT

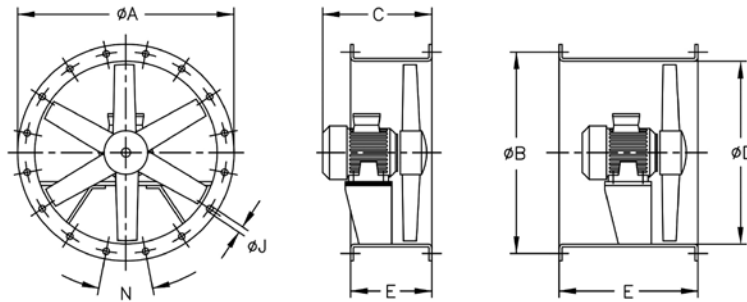

Model	ØA	ØB	C (Consult motor build sizes)							ØD	E*		ØJ	N
			132	160	180	200	225	250	280		short (Std)	long		
HGT-125	1365	1320	586	-	-	-	-	-	-	1250	500	700	15	20x18°
HGT-125	1365	1320	-	700	-	-	-	-	-	1250	500	700	15	20x18°
HGT-125	1365	1320	-	-	765	825	-	-	-	1250	700	900	15	20x18°
HGT-125	1365	1320	-	-	-	-	910	-	-	1250	700	1000	15	20x18°
HGT-125	1365	1320	-	-	-	-	-	985	-	1250	700	1000	15	20x18°
HGT-125	1365	1320	-	-	-	-	-	-	1190	1250	700	1200	15	20x18°
HGT-140	1515	1470	586	-	-	-	-	-	-	1400	400	650	15	20x18°
HGT-140	1515	1470	-	700	-	-	-	-	-	1400	450	700	15	20x18°
HGT-140	1515	1470	-	-	765	825	-	-	-	1400	550	900	15	20x18°
HGT-140	1515	1470	-	-	-	-	910	-	-	1400	550	1000	15	20x18°
HGT-140	1515	1470	-	-	-	-	-	985	-	1400	600	1000	15	20x18°
HGT-160	1735	1680	586	-	-	-	-	-	-	1600	400	650	19	24x15°
HGT-160	1735	1680	-	700	-	-	-	-	-	1600	450	700	19	24x15°
HGT-160	1735	1680	-	-	765	825	-	-	-	1600	550	900	19	24x15°
HGT-160	1735	1680	-	-	-	-	910	-	-	1600	550	1000	19	24x15°
HGT-160	1735	1680	-	-	-	-	-	985	-	1600	600	1000	19	24x15°
HGT-160	1735	1680	-	-	-	-	-	-	1190	1600	700	1200	19	24x15°

* The standard version is short casing. On request, long-casing with an inspection hatch.

Motor build sizes depending on power

Poles	r/min	CV	3	4	5.5	7.5	10	15	20	25	30	40	50	60	75	100
4T	1500	-	-	-	-	-	132	160	160	180	180	200	225	225	250	280
6T	1000	-	132	132	132	160	160	160	180	200	200	225	250	280	280	280
8T	750	-	132	132	160	160	160	180	200	225	225	250	-	-	-	-

HGTX

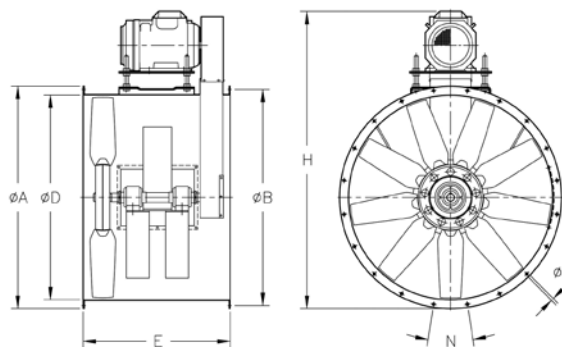

Model	ØA	ØB	ØD	E	H (Consult motor build sizes)							ØJ	N	
					132	160	180	200	225	250	280			
HGT-X 125	1365	1320	1250	900	1743	1815	1850	-	-	-	-	-	15	20x18°
HGT-X 125	1365	1320	1250	960	-	-	-	1930	1995	-	-	-	15	20x18°
HGT-X 125	1365	1320	1250	1100	-	-	-	-	-	2060	-	-	15	20x18°
HGT-X 125	1365	1320	1250	1100	-	-	-	-	-	-	2090	-	15	20x18°

Motor build sizes depending on power

Poles	r/min	CV	3	4	5.5	7.5	10	15	20	25	30	40	50	60	75	100
4T	1500	-	-	-	-	-	132	160	160	180	180	200	225	225	250	280
6T	1000	-	132	132	132	160	160	160	180	200	200	225	250	280	280	280
8T	750	-	132	132	160	160	160	180	200	225	225	250	-	-	-	-

EXAMPLE OF SELECTION

Characteristic Curves

Q = Airflow in m³/h, m³/s and cfm.

Pe = Static pressure in mm H₂O, Pa and inwg.

Impeller diameter (cm): 125 Number of poles: 8 Number of blades: 3

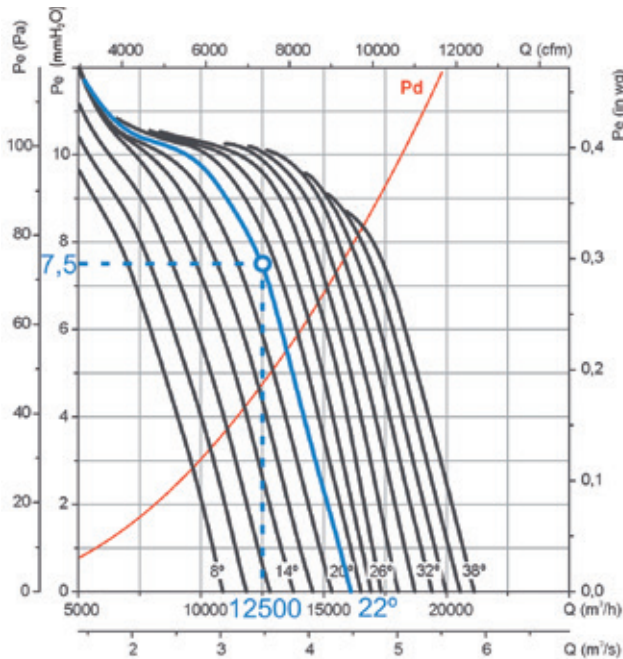

Initial data

- Working point:
- Airflow: 12,500 m³/h
- Load loss: 7.5 mmH₂O

Steps for selecting equipment

On the pressure graph:

- 1 Mark the working point, defined by the airflow (12,500 m³/h) and the load loss (7.5 mmH₂O).
- 2 Select the curve of the equipment which is closest above the working point. In our case, a curve with a blade angle of 22° is obtained.

On the power graph:

- 3 Mark the working point, defined by the airflow (12,500 m³/h) and the selected blade angle (22°).
- 4 Read the absorbed power on the power axis on the left. Pa = 560 W at the working point.
- 5 Look for the straight red line which is closest to the working point above. On the right-hand side of the graph, the value of the installed motor power is obtained. In our case, this is 0.75 kW or 1 HP

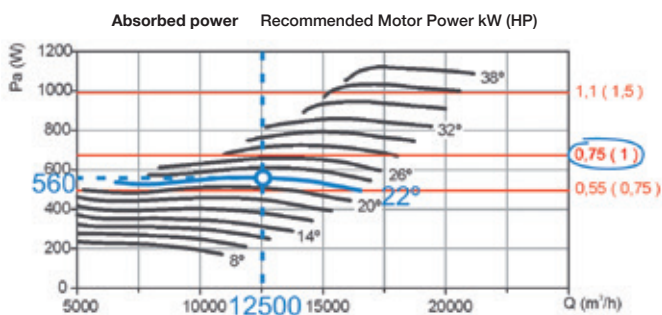

EXAMPLE OF ORDER CODE

HGT — 125 — 8T — 3 — 1 — 22

HGT: Large diameter long cased axial fans with direct drive motor
 HGTX: Large diameter long cased axial fans with external motor

Impeller diameter in cm.

Number of motor poles
 4=1400 r/min. 50 Hz
 6=900 r/min. 50 Hz
 8=750 r/min. 50 Hz

T=Three-phase
 M=Single-phase

Number of blades:
 3 blades
 6 blades
 9 blades

Motor power (HP)

Angle of inclination of the blades

Characteristic Curves

Q = Airflow in m³/h, m³/s and cfm.

Pe = Static pressure in mmH₂O, Pa and inwg.

Impeller diameter (cm): 125

Number of poles: 4

Number of blades: 3

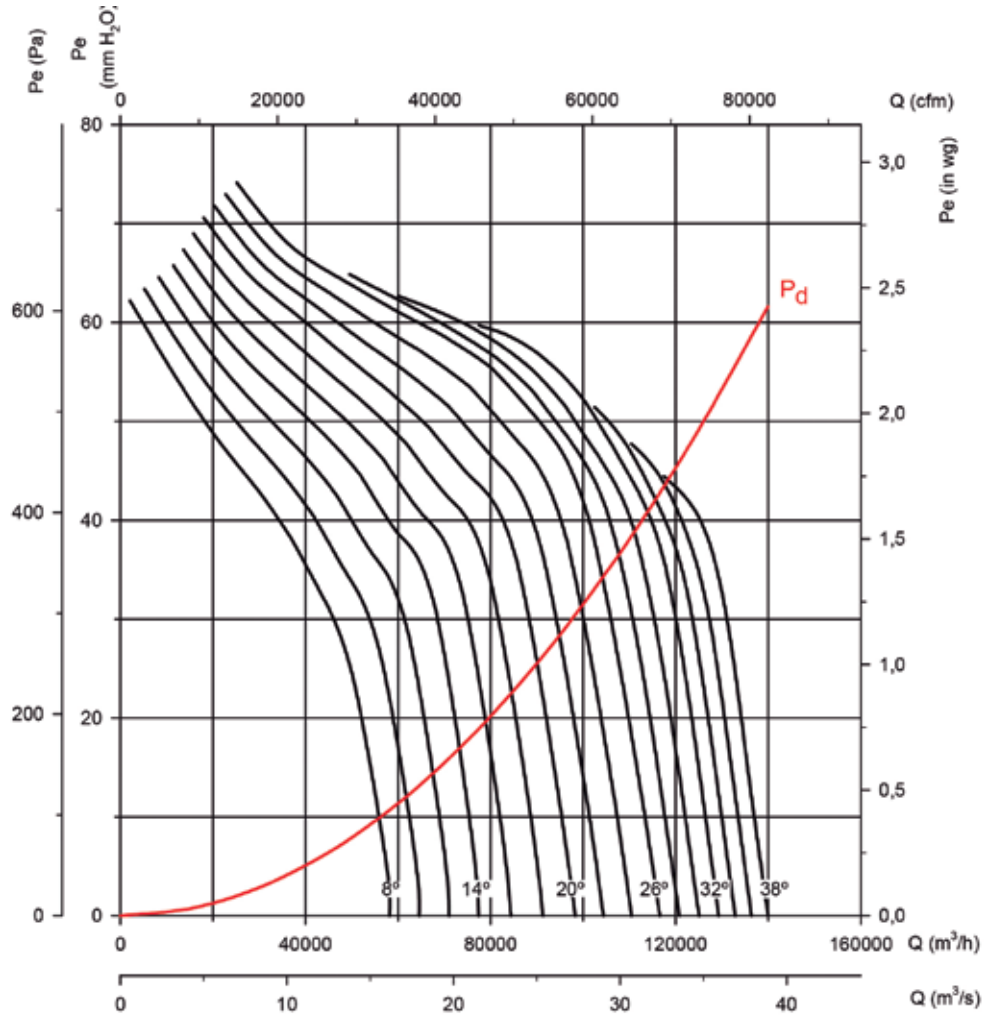

Absorbed power

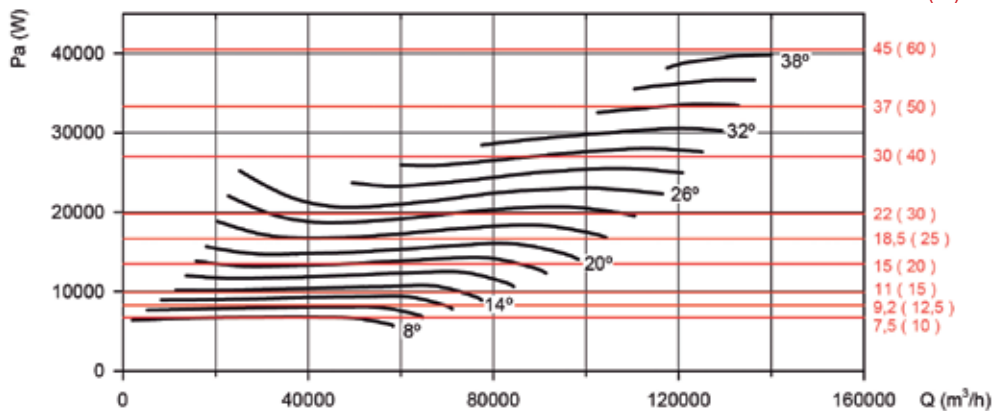

Recommended motor power kW (HP)



Available features best efficiency point (BEP) at the end of the series.

Characteristic Curves

Q = Airflow in m³/h, m³/s and cfm.

Pe = Static pressure in mmH₂O, Pa and inwg.

Impeller diameter (cm): 125

Number of poles: 4

Number of blades: 6

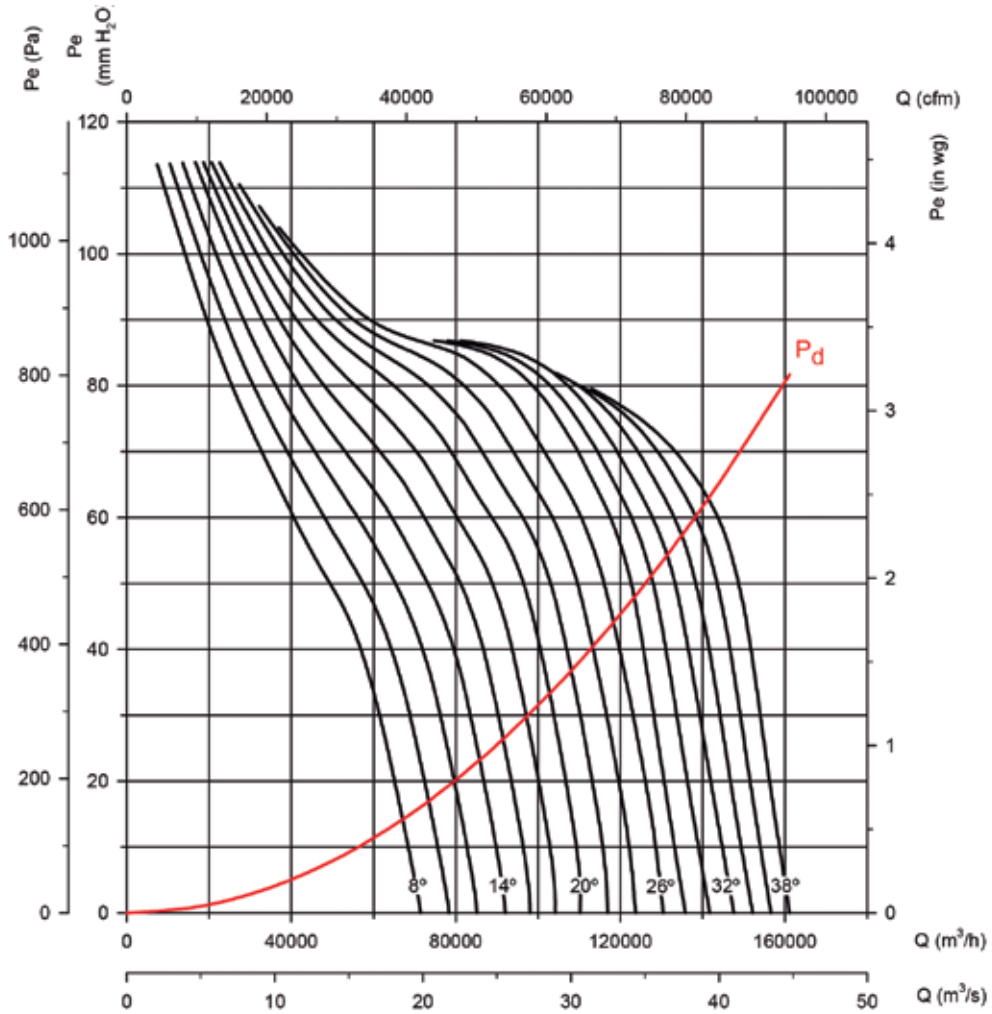

Absorbed power

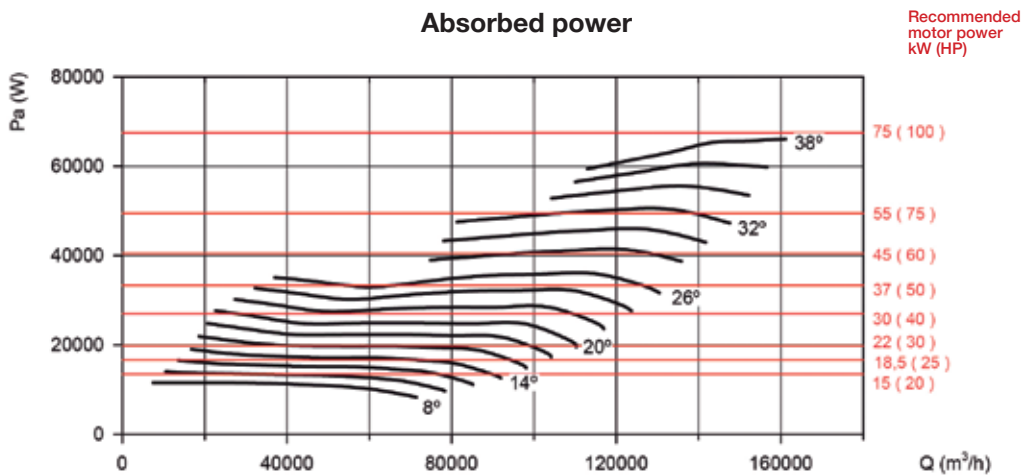

Available features best efficiency point (BEP) at the end of the series.

Characteristic Curves

Q = Airflow in m³/h, m³/s and cfm.

Pe = Static pressure in mmH₂O, Pa and inwg.

Impeller diameter (cm): 125

Number of poles: 4

Number of blades: 9

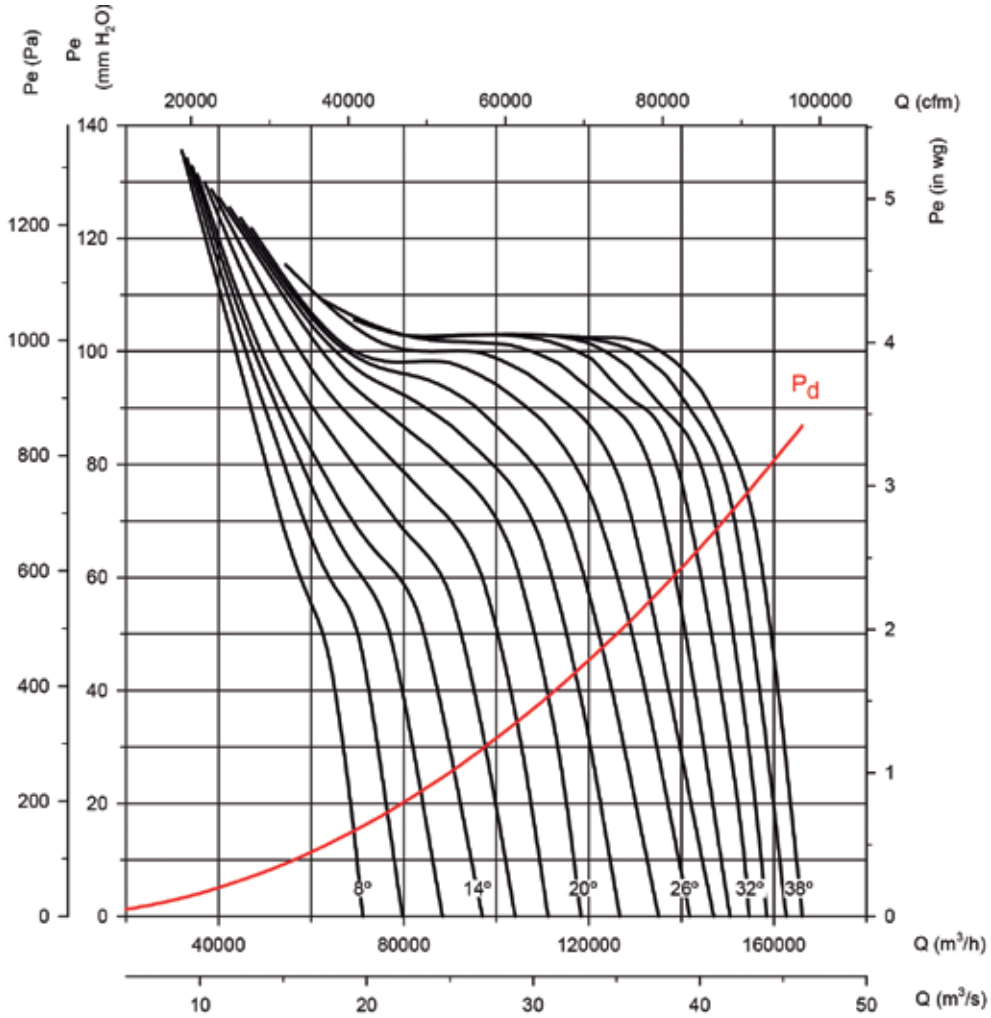

Absorbed power

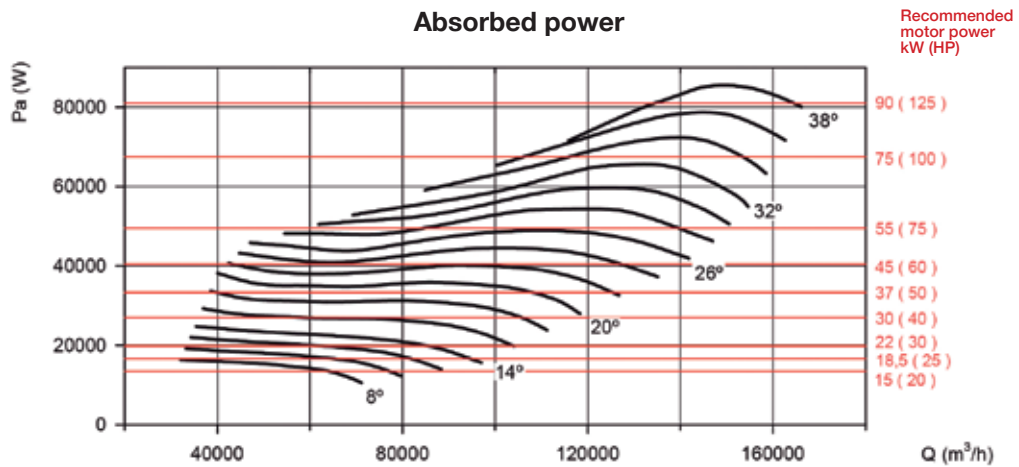

Available features best efficiency point (BEP) at the end of the series.

Characteristic Curves

Q = Airflow in m³/h, m³/s and cfm.

Pe = Static pressure in mmH₂O, Pa and inwg.

Impeller diameter (cm): 125

Number of poles: 6

Number of blades: 3

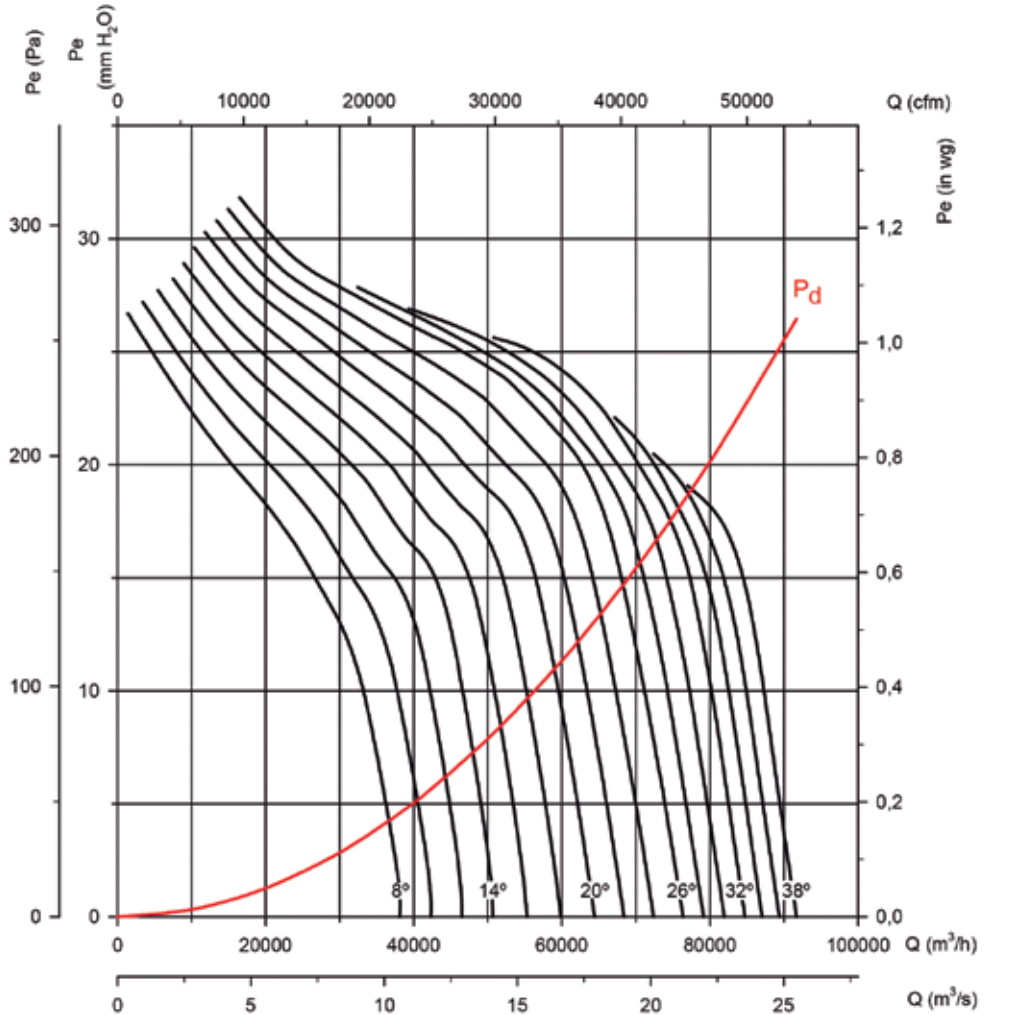

Absorbed power

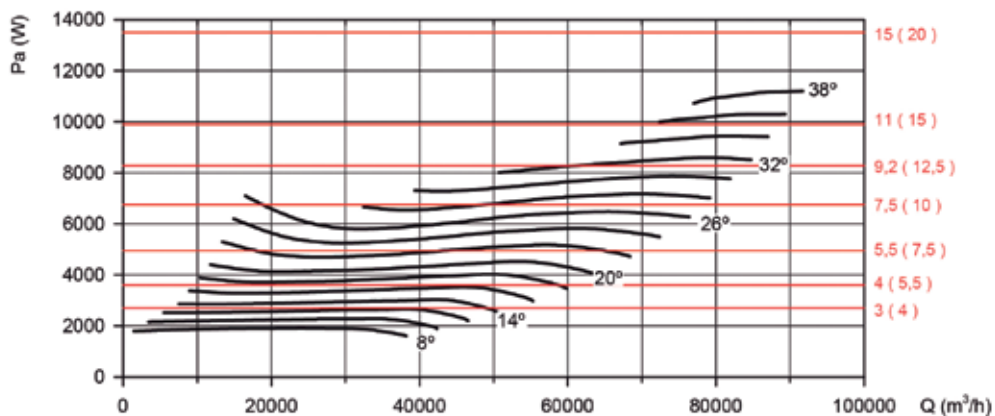

Available features best efficiency point (BEP) at the end of the series.

Characteristic Curves

Q = Airflow in m³/h, m³/s and cfm.

Pe = Static pressure in mmH₂O, Pa and inwg.

Impeller diameter (cm): 125

Number of poles: 6

Number of blades: 6

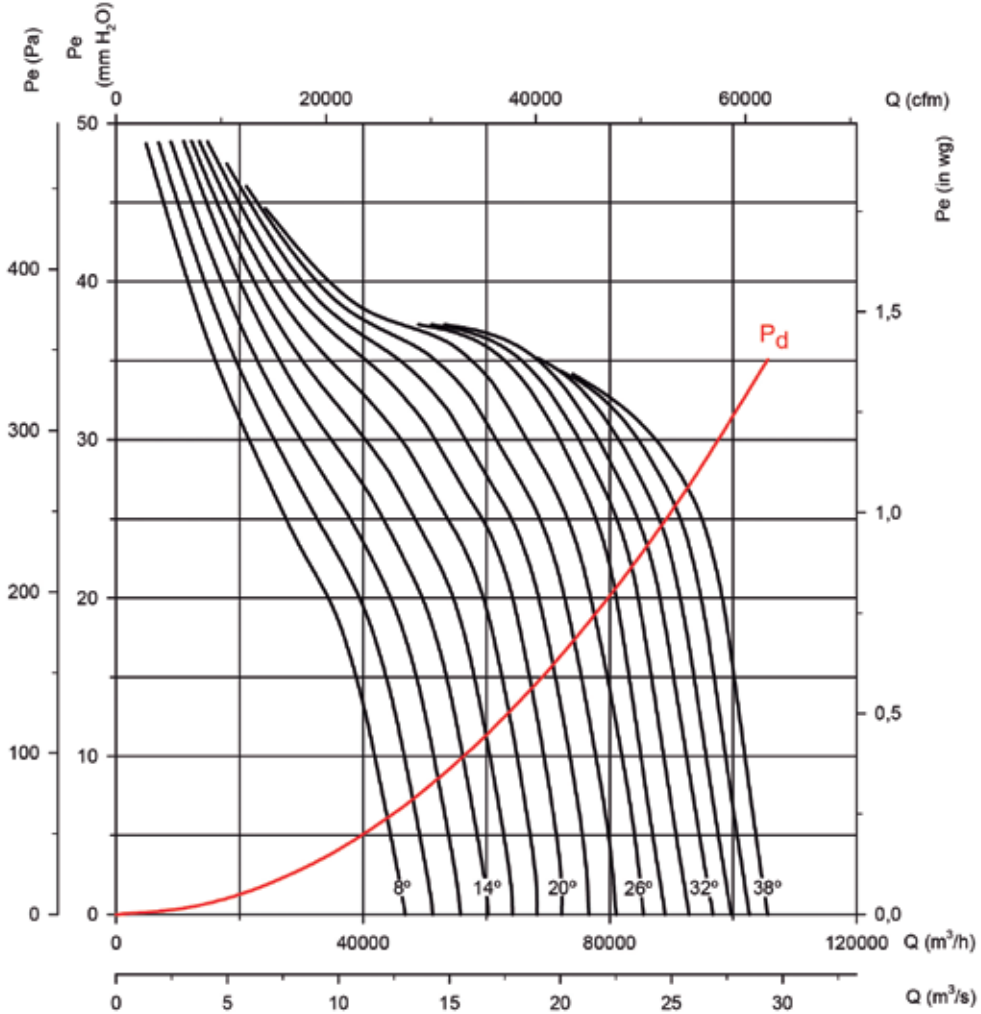

Absorbed power

Recommended motor power
kW (HP)

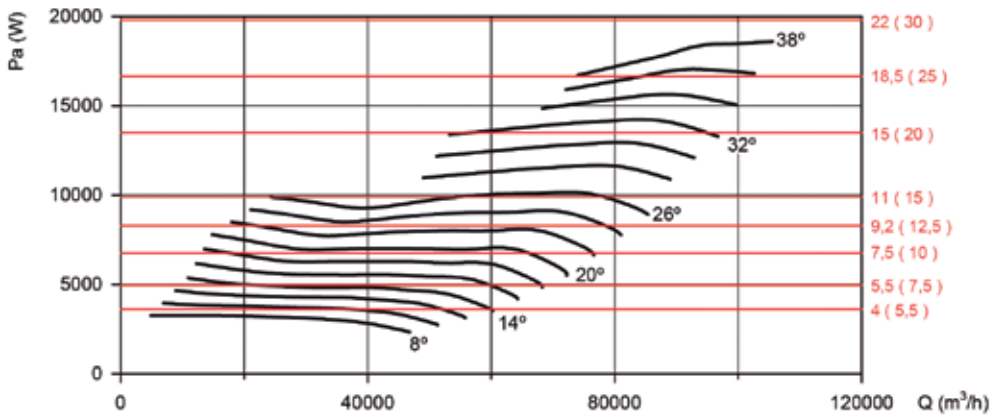

Available features best efficiency point (BEP) at the end of the series.

Characteristic Curves

Q = Airflow in m³/h, m³/s and cfm.

Pe = Static pressure in mmH₂O, Pa and inwg.

Impeller diameter (cm): 125

Number of poles: 6

Number of blades: 9

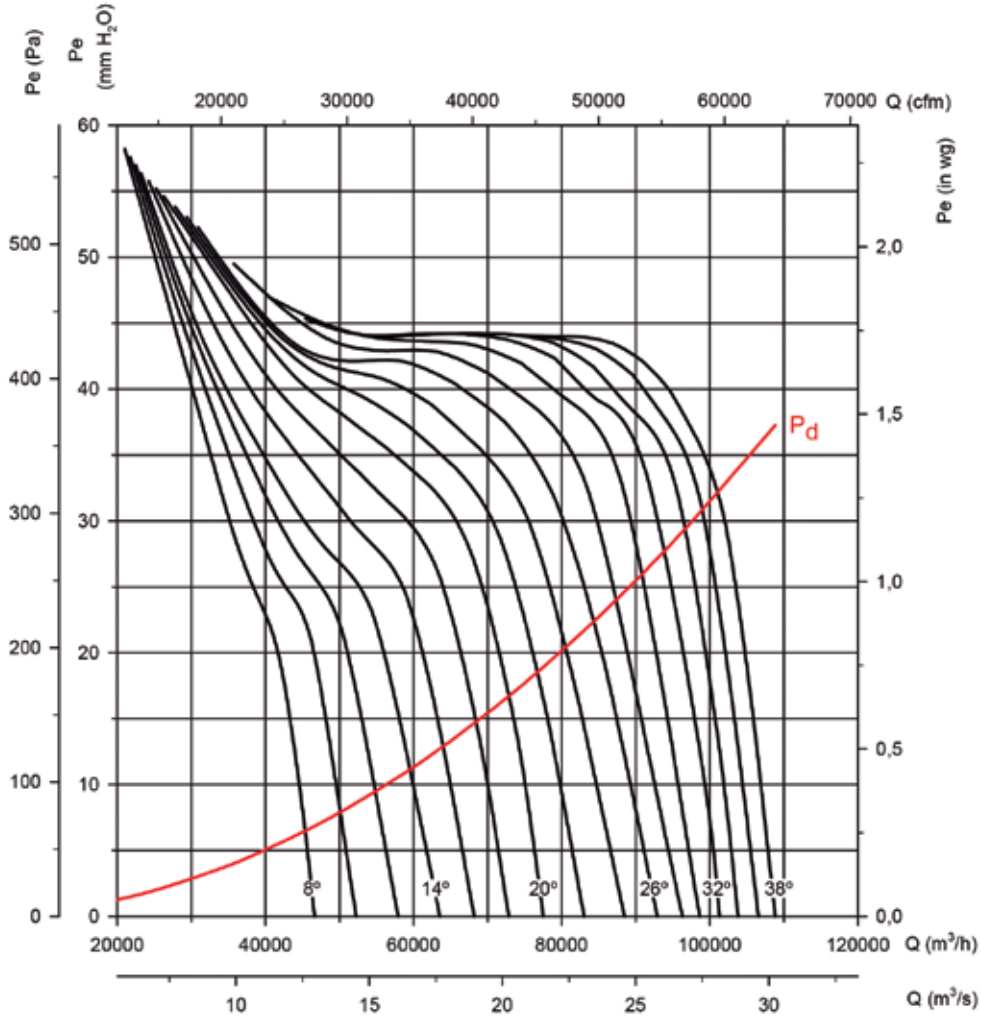

Absorbed power

Recommended motor power kW (HP)

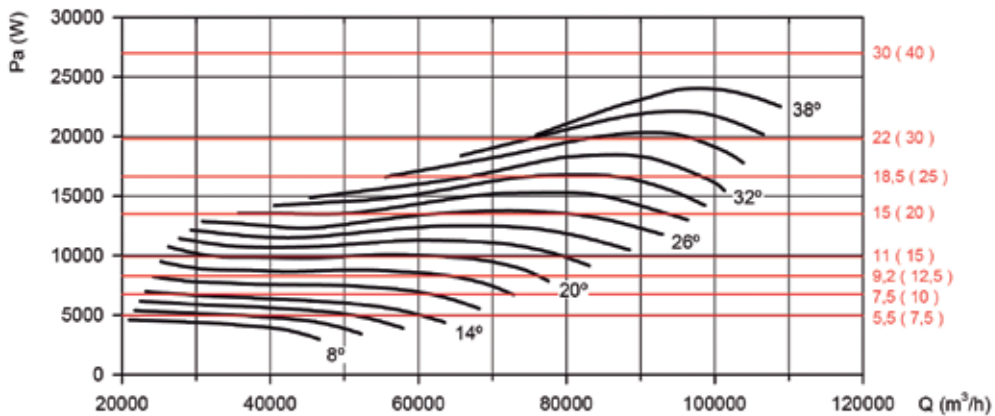

Available features best efficiency point (BEP) at the end of the series.

Characteristic Curves

Q = Airflow in m³/h, m³/s and cfm.

Pe = Static pressure in mmH₂O, Pa and inwg.

Impeller diameter (cm): 125

Number of poles: 8

Number of blades: 3

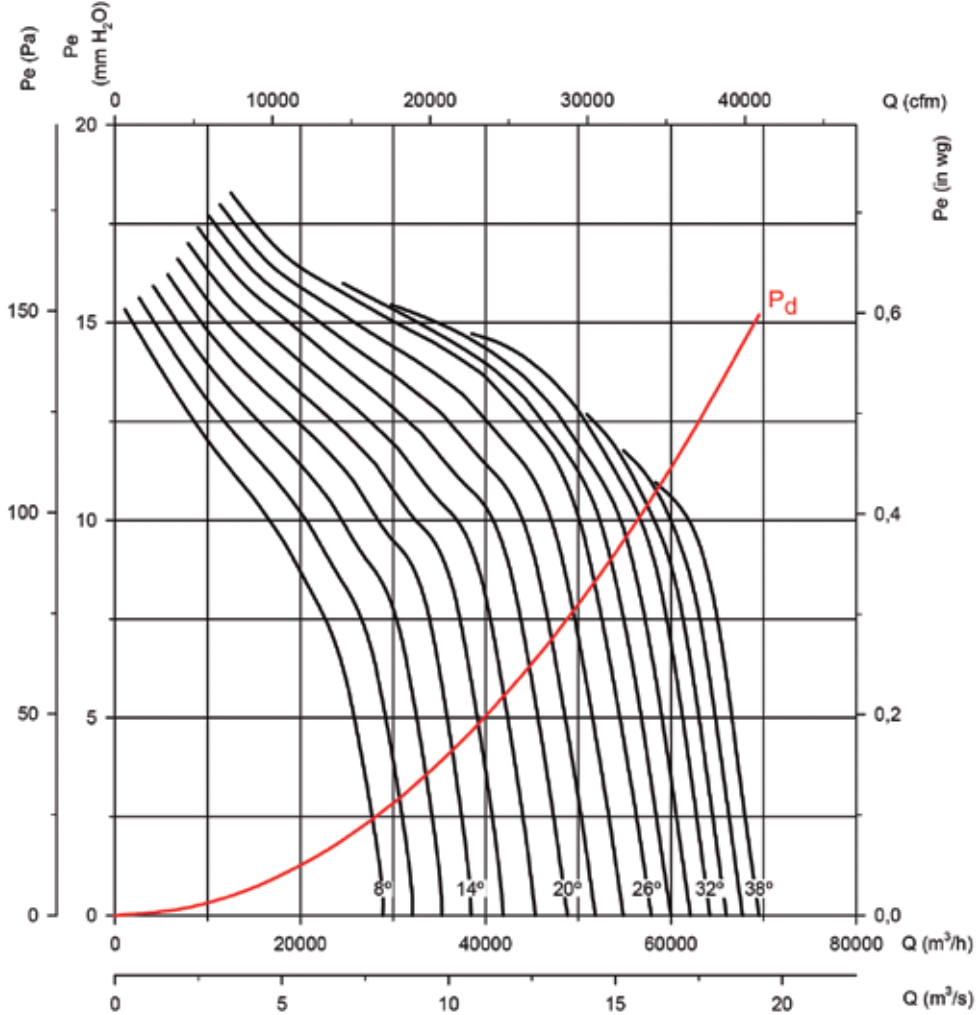

Absorbed power

Recommended motor power kW (HP)

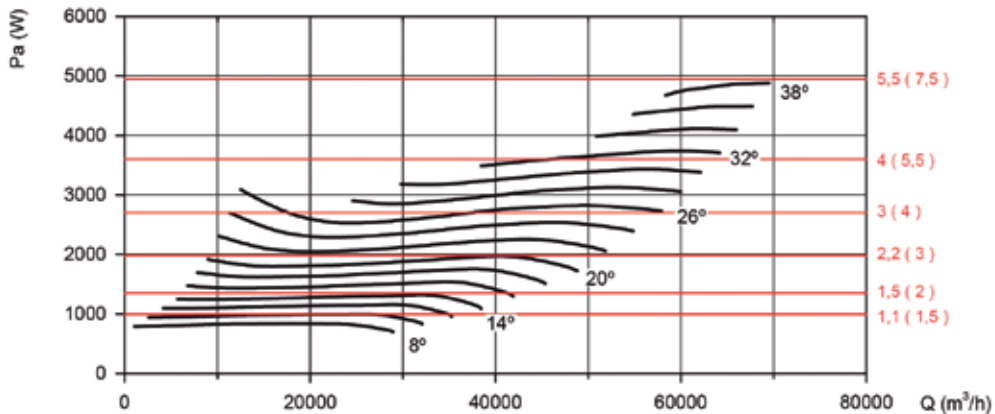

Available features best efficiency point (BEP) at the end of the series.

Characteristic Curves

Q = Airflow in m³/h, m³/s and cfm.

Pe = Static pressure in mmH₂O, Pa and inwg.

Impeller diameter (cm): 125

Number of poles: 8

Number of blades: 6

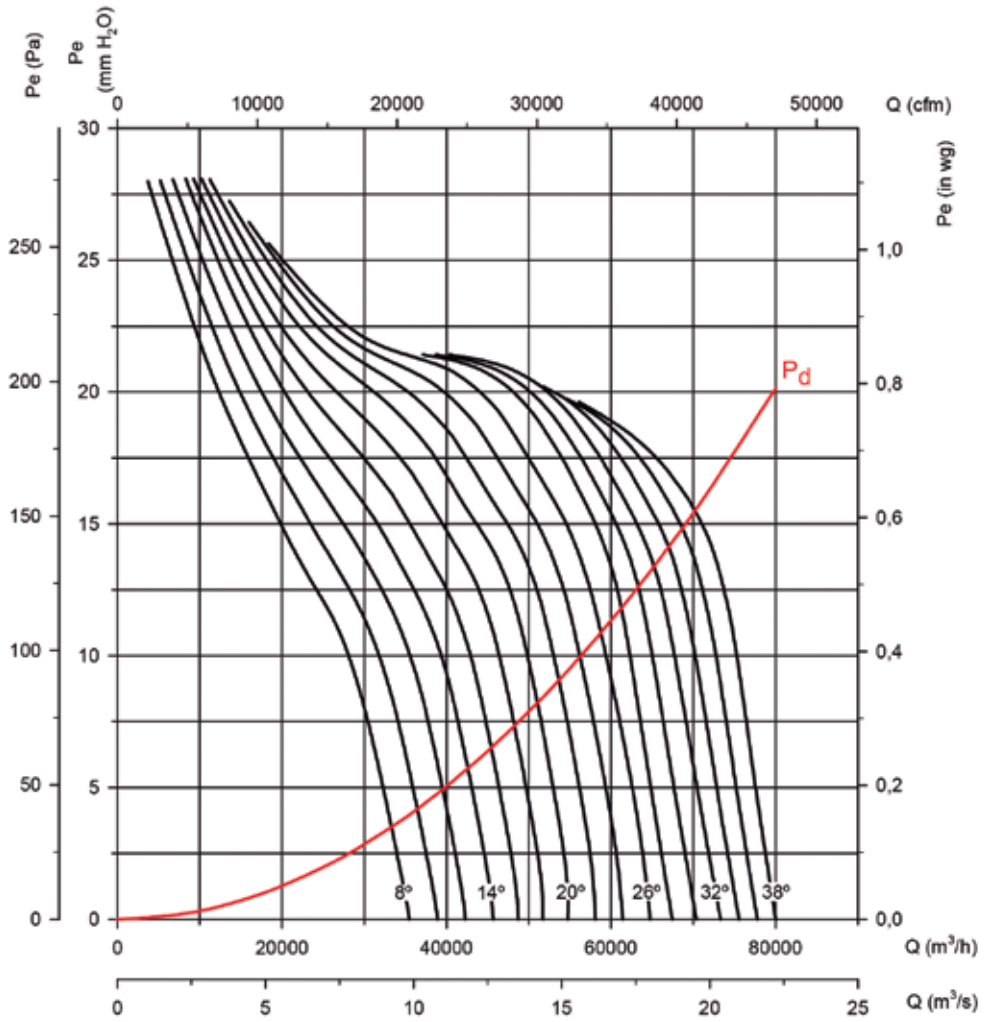

Absorbed power

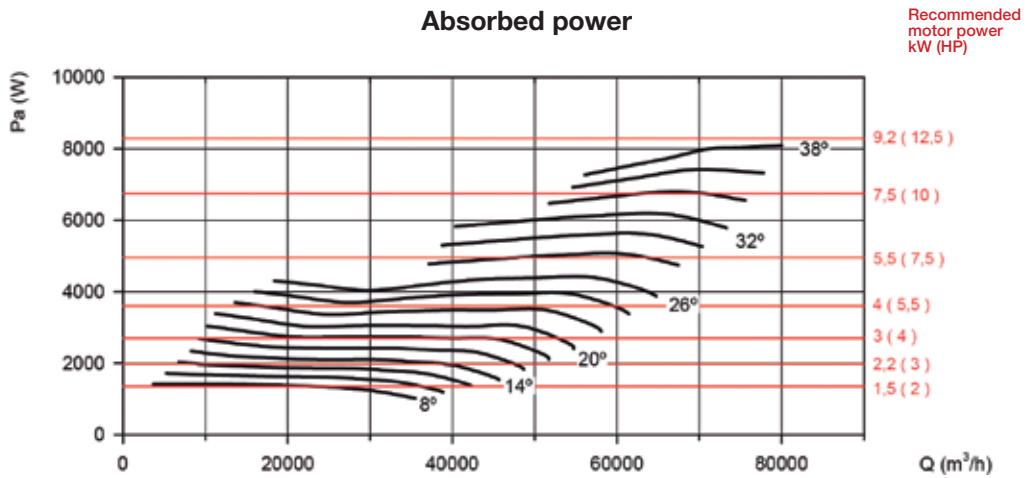

Recommended motor power kW (HP)



Available features best efficiency point (BEP) at the end of the series.

Characteristic Curves

Q = Airflow in m³/h, m³/s and cfm.

Pe = Static pressure in mmH₂O, Pa and inwg.

Impeller diameter (cm): 125

Number of poles: 8

Number of blades: 9

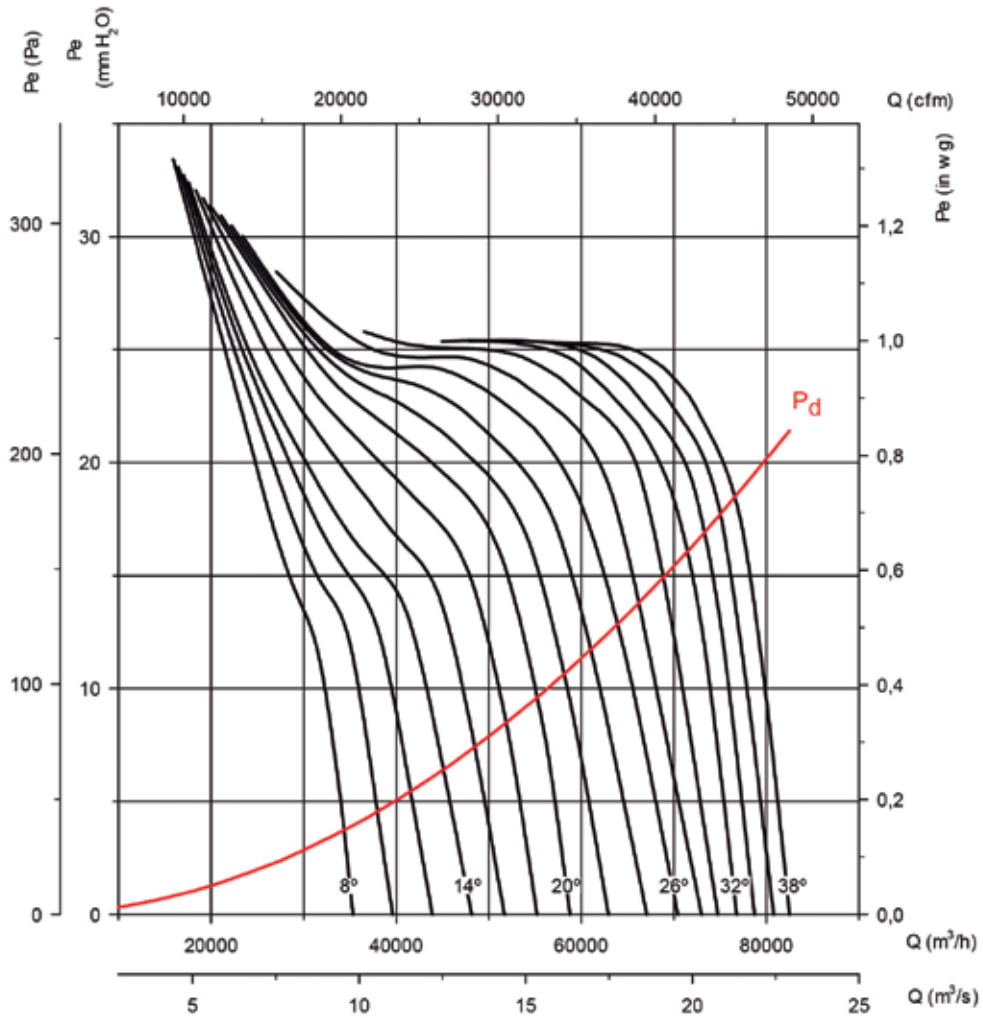

Absorbed power

Recommended motor power kW (HP)

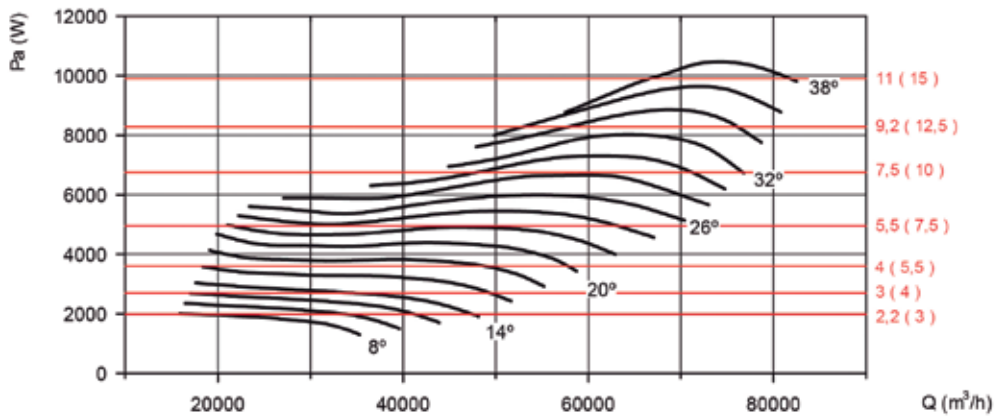

Available features best efficiency point (BEP) at the end of the series.

Characteristic Curves

Q = Airflow in m³/h, m³/s and cfm.

Pe = Static pressure in mmH₂O, Pa and inwg.

Impeller diameter (cm): 140

Number of poles: 6

Number of blades: 3

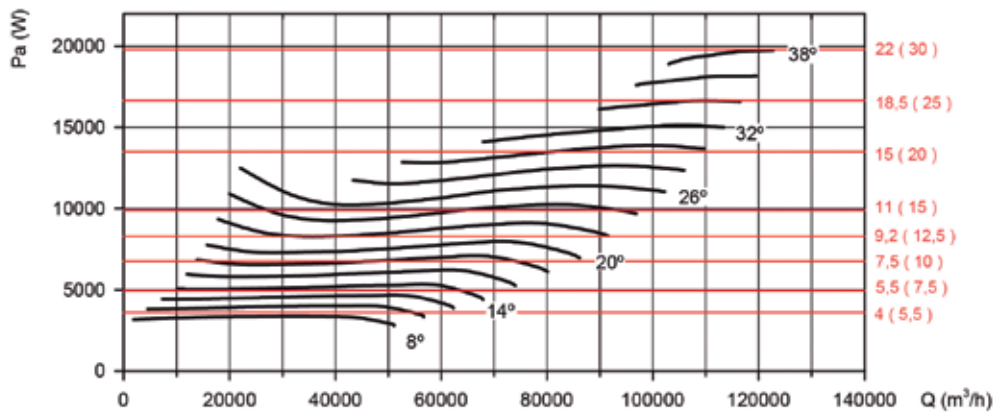
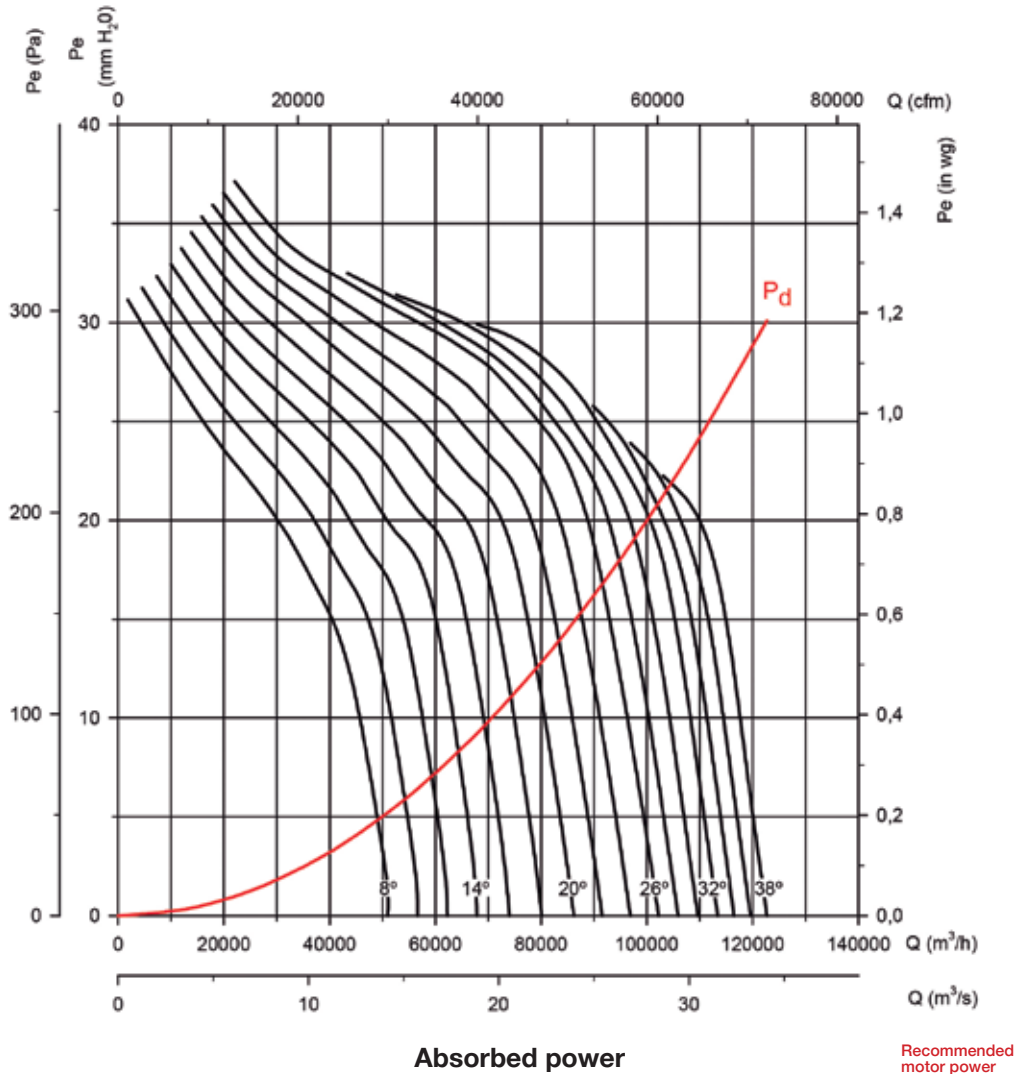

Available features best efficiency point (BEP) at the end of the series.

Characteristic Curves

Q = Airflow in m³/h, m³/s and cfm.

Pe = Static pressure in mmH₂O, Pa and inwg.

Impeller diameter (cm): 140

Number of poles: 6

Number of blades: 6

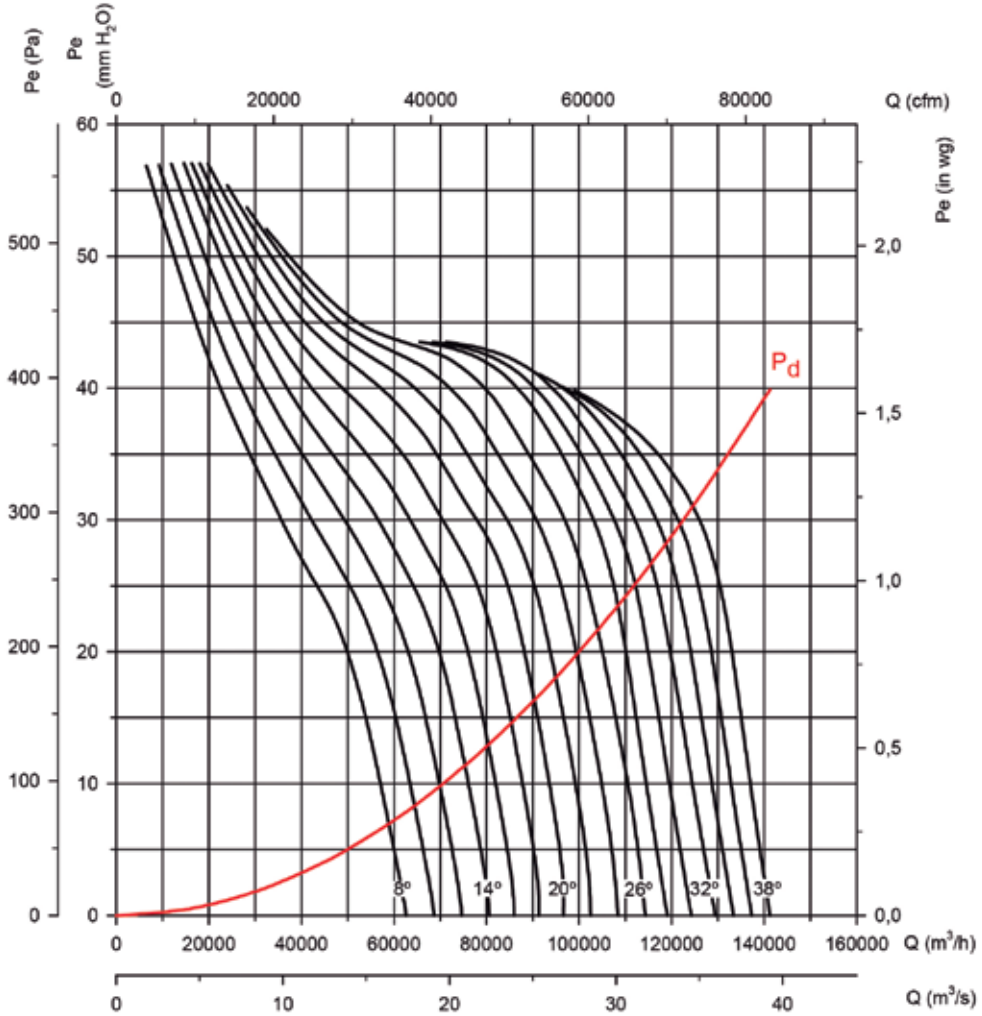

Absorbed power

Recommended motor power kW (HP)

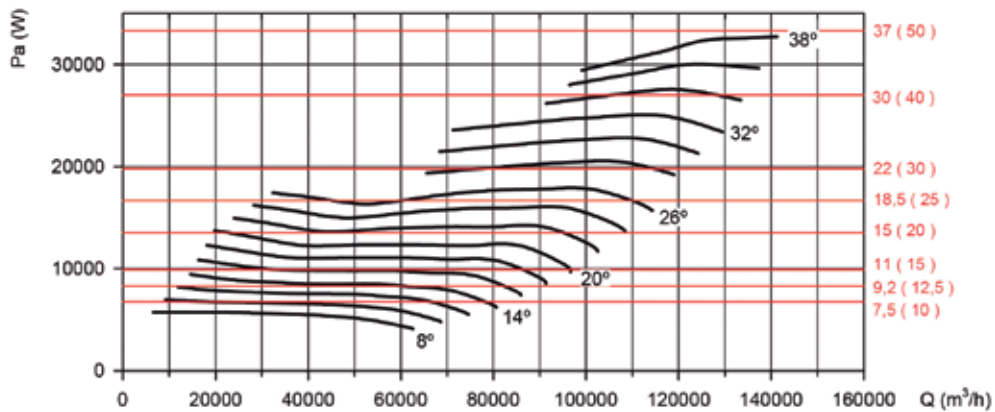

Available features best efficiency point (BEP) at the end of the series.

Characteristic Curves

Q = Airflow in m³/h, m³/s and cfm.

Pe = Static pressure in mmH₂O, Pa and inwg.

Impeller diameter (cm): 140

Number of poles: 6

Number of blades: 9

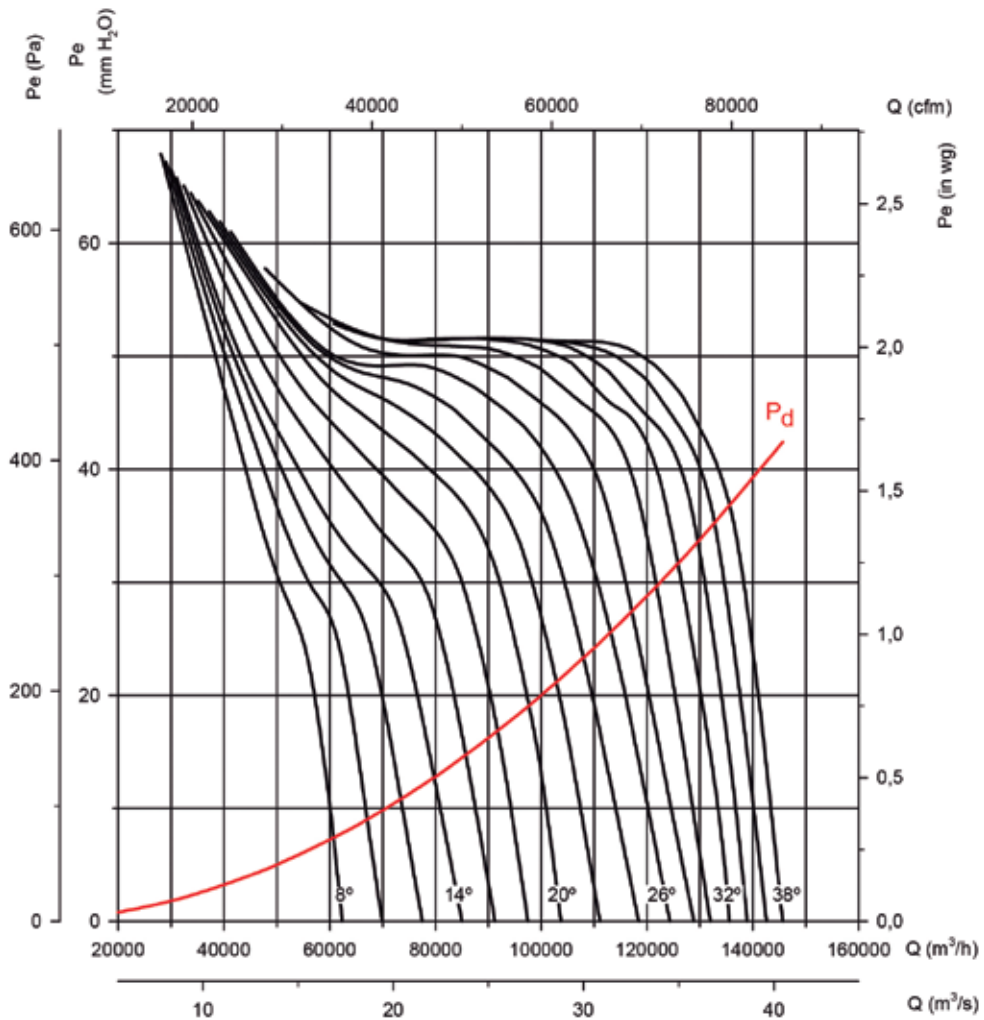

Absorbed power

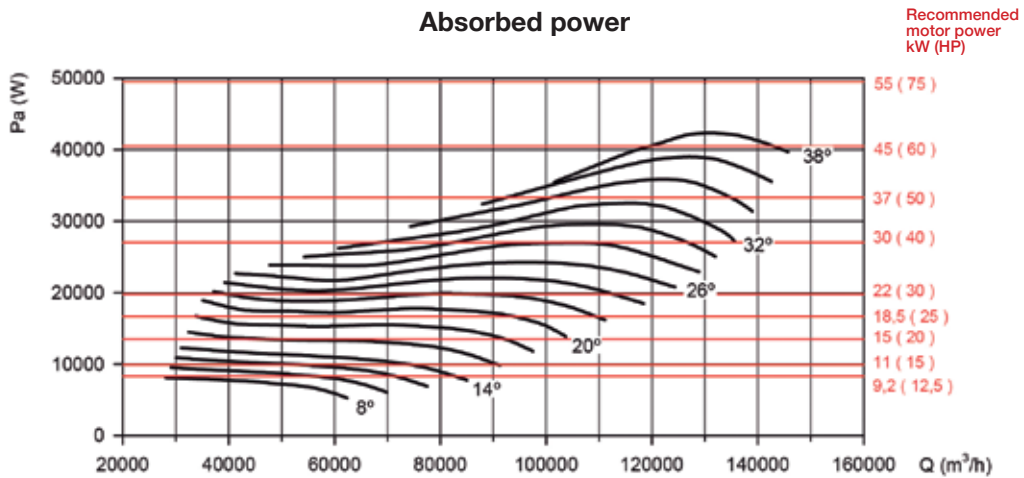

Recommended motor power kW (HP)



Available features best efficiency point (BEP) at the end of the series.

Characteristic Curves

Q = Airflow in m³/h, m³/s and cfm.

Pe= Static pressure in mmH₂O, Pa and inwg.

Impeller diameter (cm): 140

Number of poles: 8

Number of blades: 3

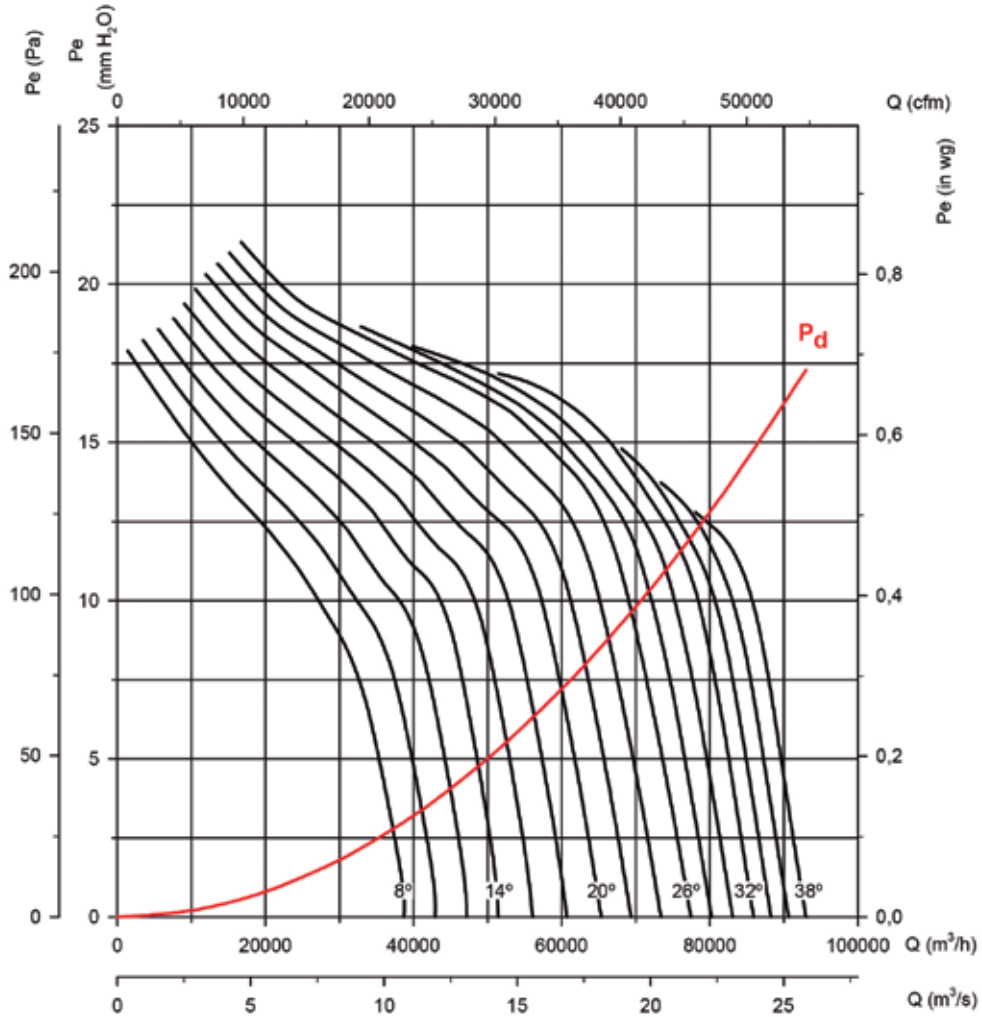

Absorbed power

Recommended motor power kW (HP)

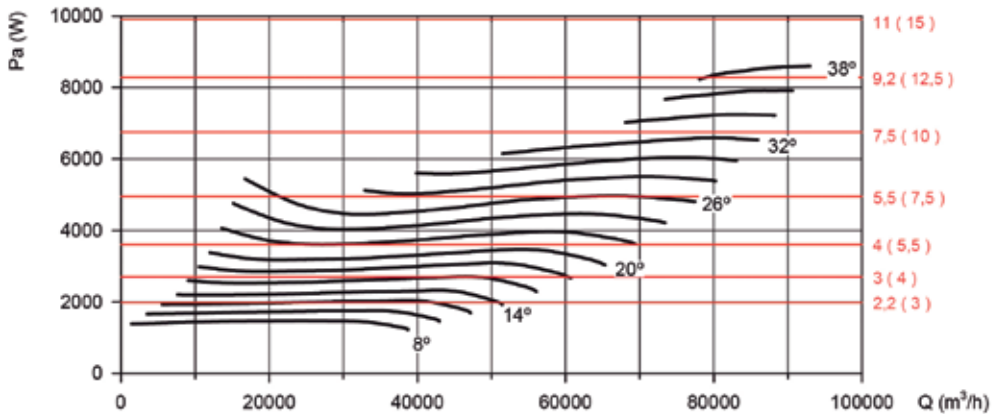

Available features best efficiency point (BEP) at the end of the series.

Characteristic Curves

Q = Airflow in m³/h, m³/s and cfm.

Pe = Static pressure in mmH₂O, Pa and inwg.

Impeller diameter (cm): 140

Number of poles: 8

Number of blades: 6

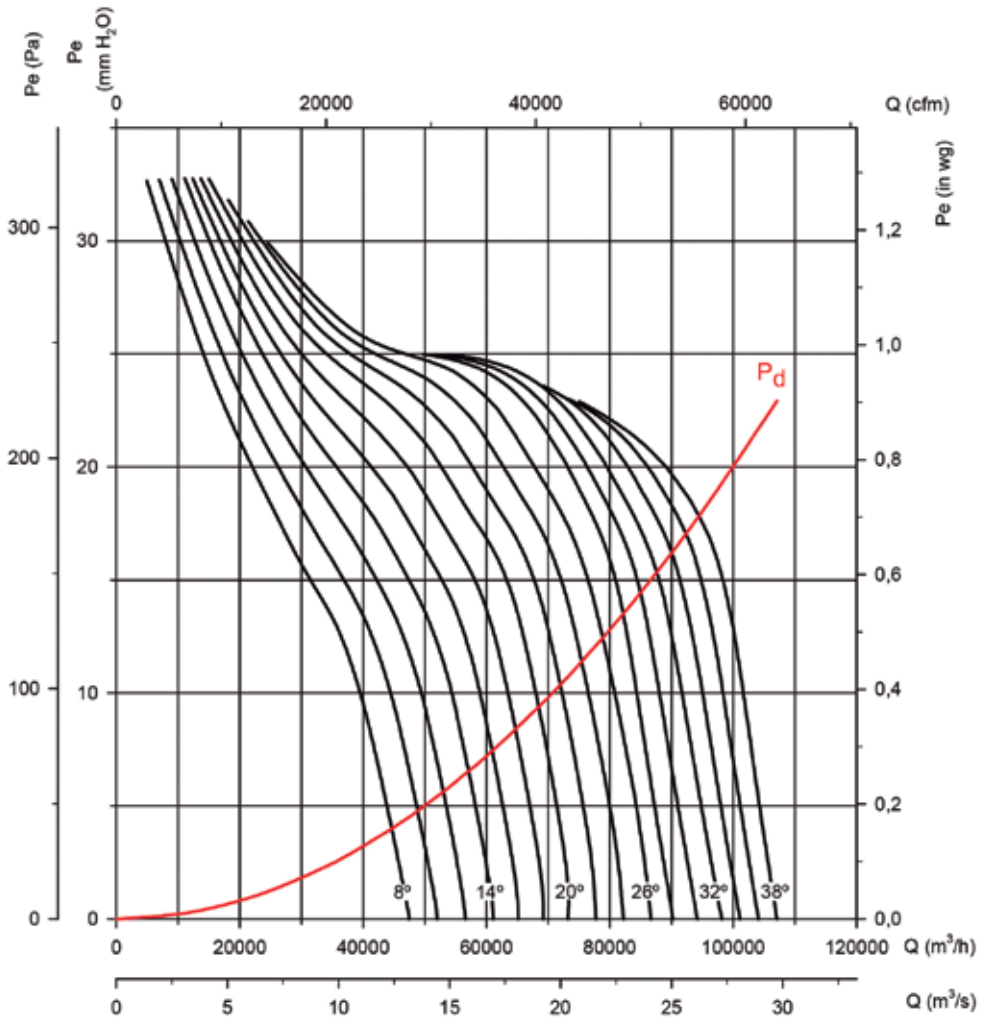

Absorbed power

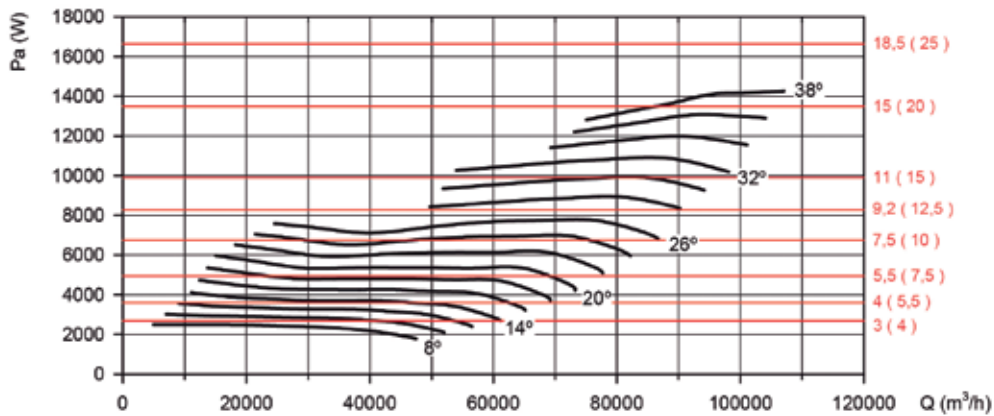

Recommended motor power kW (HP)



Available features best efficiency point (BEP) at the end of the series.

Characteristic Curves

Q = Airflow in m³/h, m³/s and cfm.

Pe = Static pressure in mmH₂O, Pa and inwg.

Impeller diameter (cm): 140

Number of poles: 8

Number of blades: 9

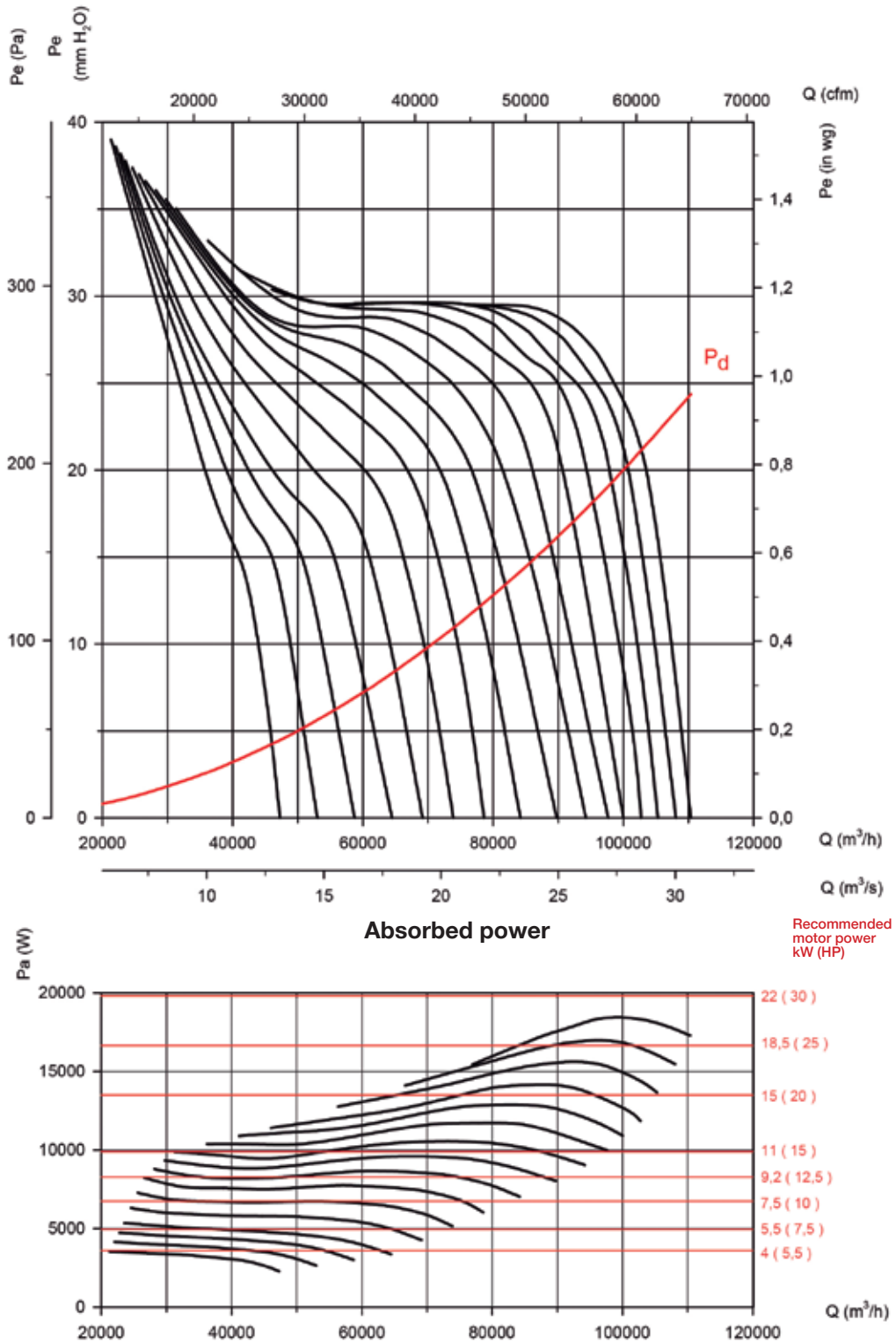

Available features best efficiency point (BEP) at the end of the series.

Characteristic Curves

Q = Airflow in m³/h, m³/s and cfm.

Pe = Static pressure in mmH₂O, Pa and inwg.

Impeller diameter (cm): 140

Number of poles: 6

Number of blades: 3

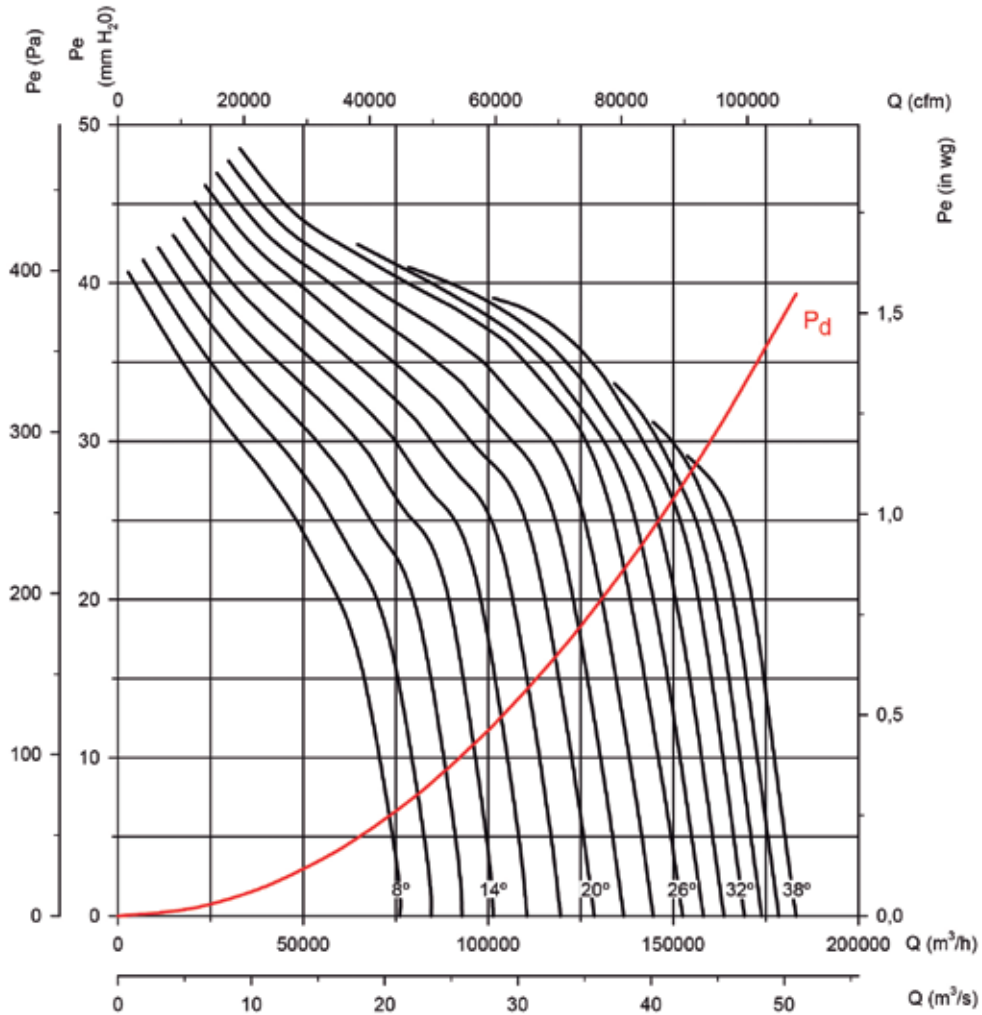

Absorbed power

Recommended motor power kW (HP)

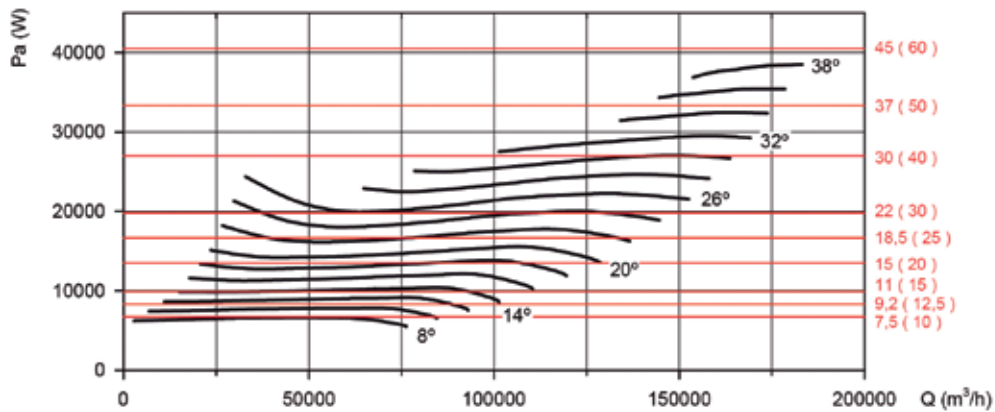

Available features best efficiency point (BEP) at the end of the series.

Characteristic Curves

Q = Airflow in m³/h, m³/s and cfm.

Pe = Static pressure in mmH₂O, Pa and inwg.

Impeller diameter (cm): 160

Number of poles: 6

Number of blades: 6

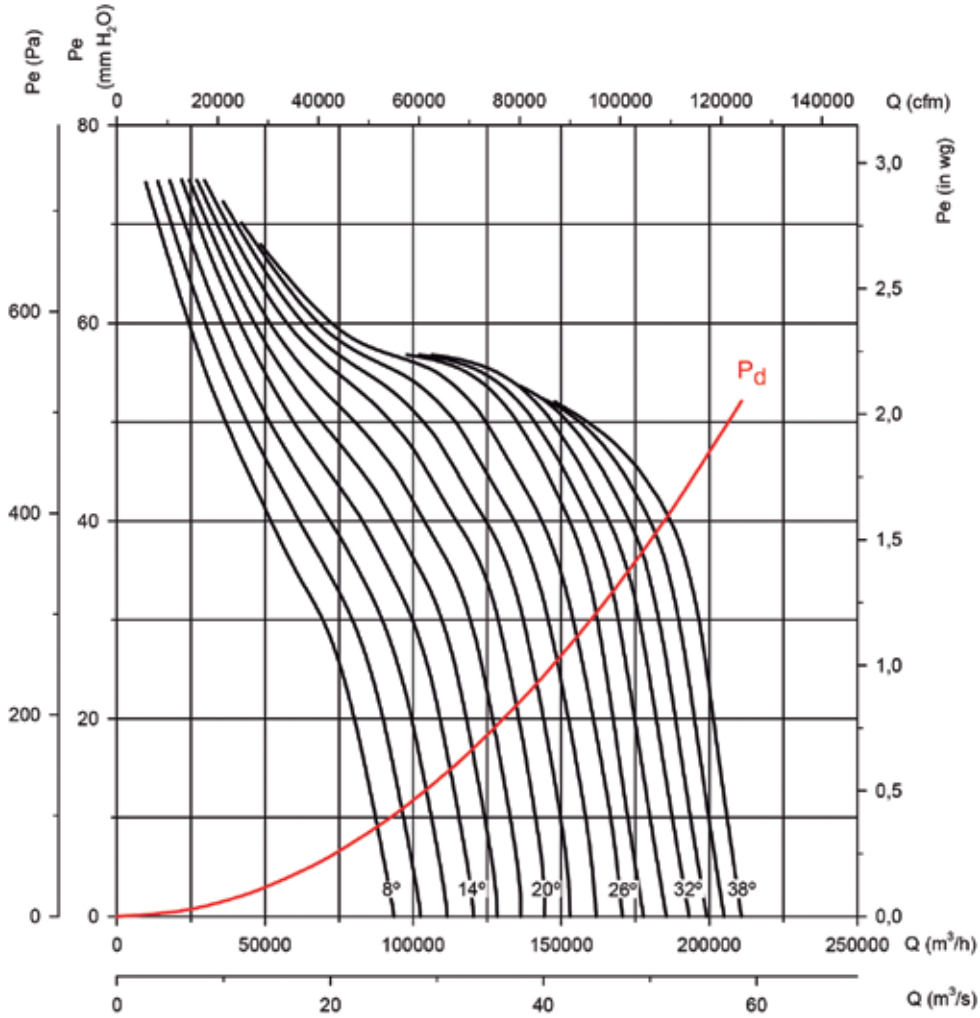

Absorbed power

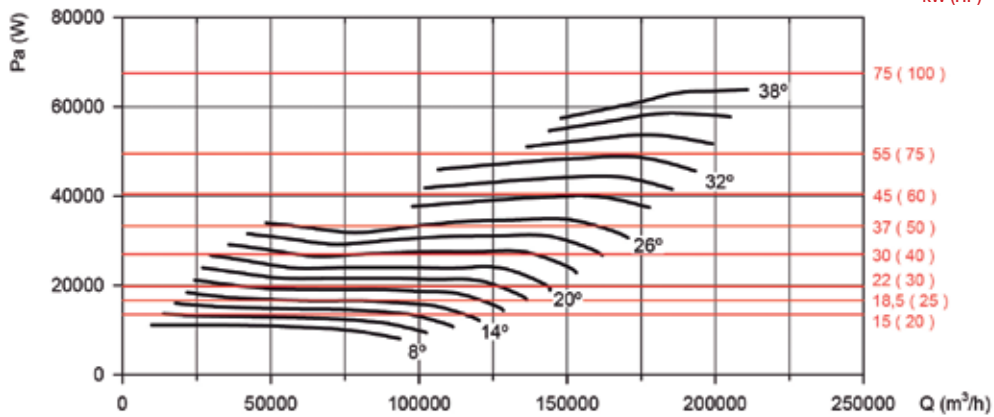

Available features best efficiency point (BEP) at the end of the series.

Characteristic Curves

Q = Airflow in m³/h, m³/s and cfm.

Pe = Static pressure in mmH₂O, Pa and inwg.

Impeller diameter (cm): 160

Number of poles: 6

Number of blades: 9

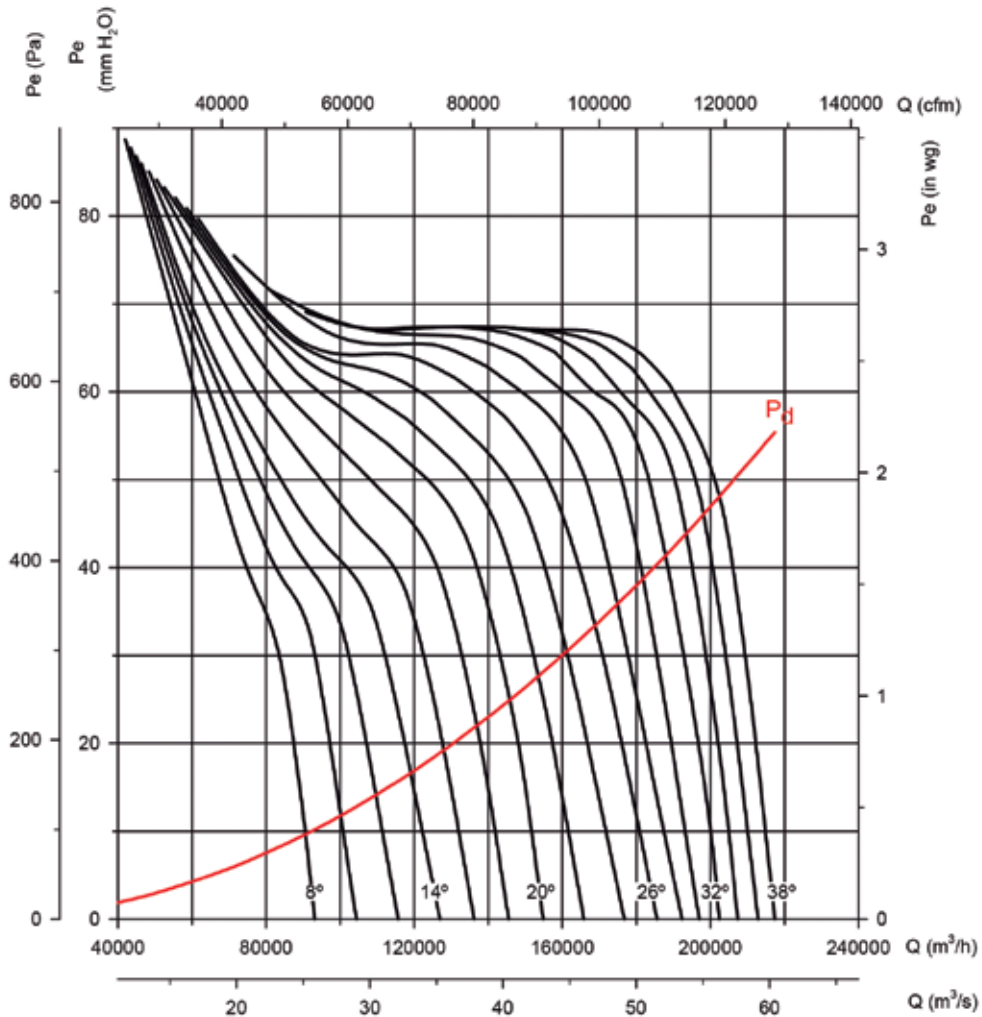

Absorbed power

Recommended motor power kW (HP)

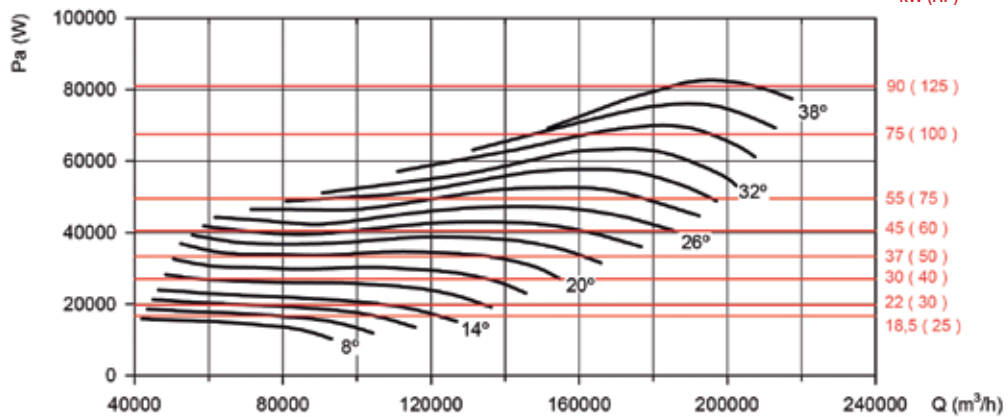

Available features best efficiency point (BEP) at the end of the series.

Characteristic Curves

Q = Airflow in m³/h, m³/s and cfm.

Pe = Static pressure in mmH₂O, Pa and inwg.

Impeller diameter (cm): 160

Number of poles: 8

Number of blades: 3

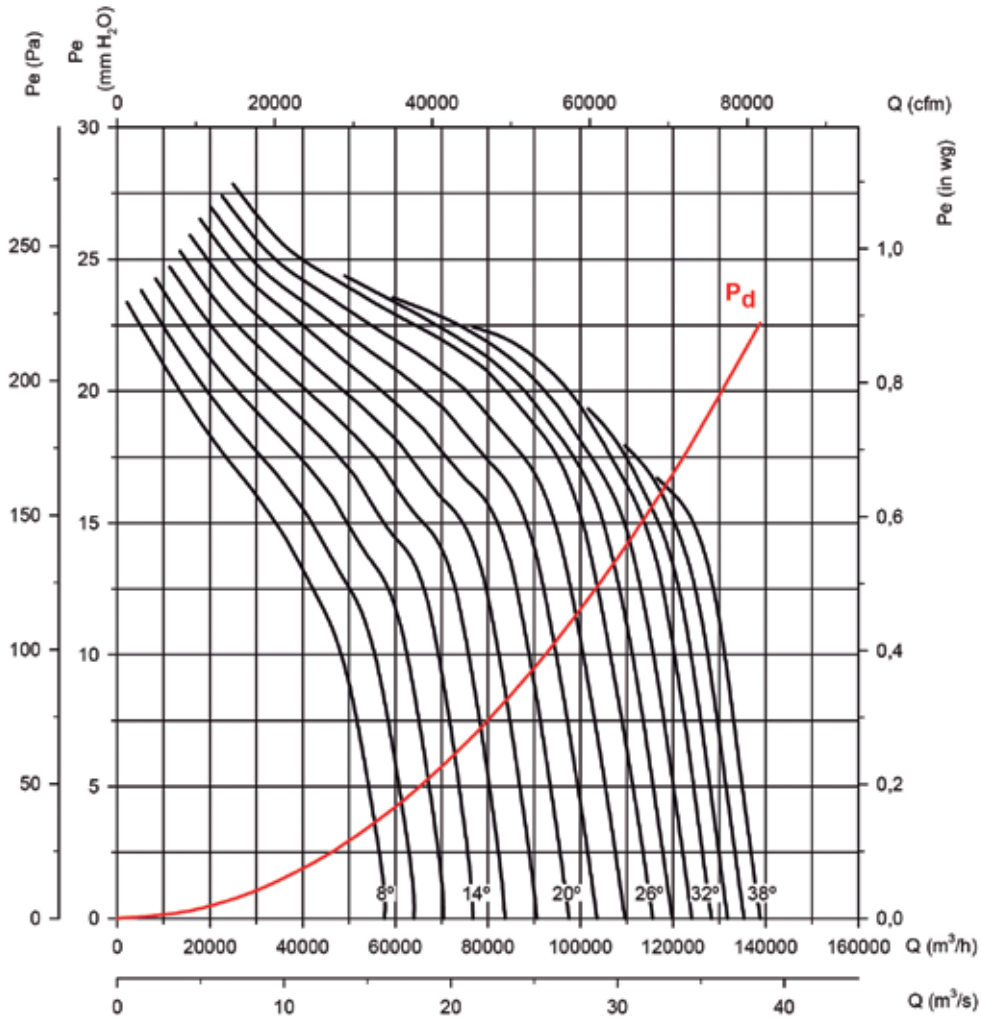

Absorbed power

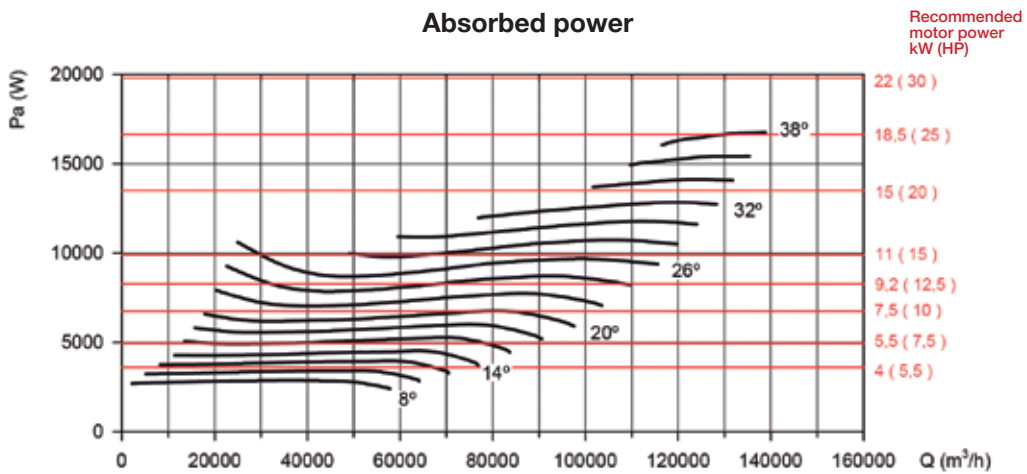

Available features best efficiency point (BEP) at the end of the series.

Characteristic Curves

Q = Airflow in m³/h, m³/s and cfm.

Pe = Static pressure in mmH₂O, Pa and inwg.

Impeller diameter (cm): 160

Number of poles: 8

Number of blades: 6

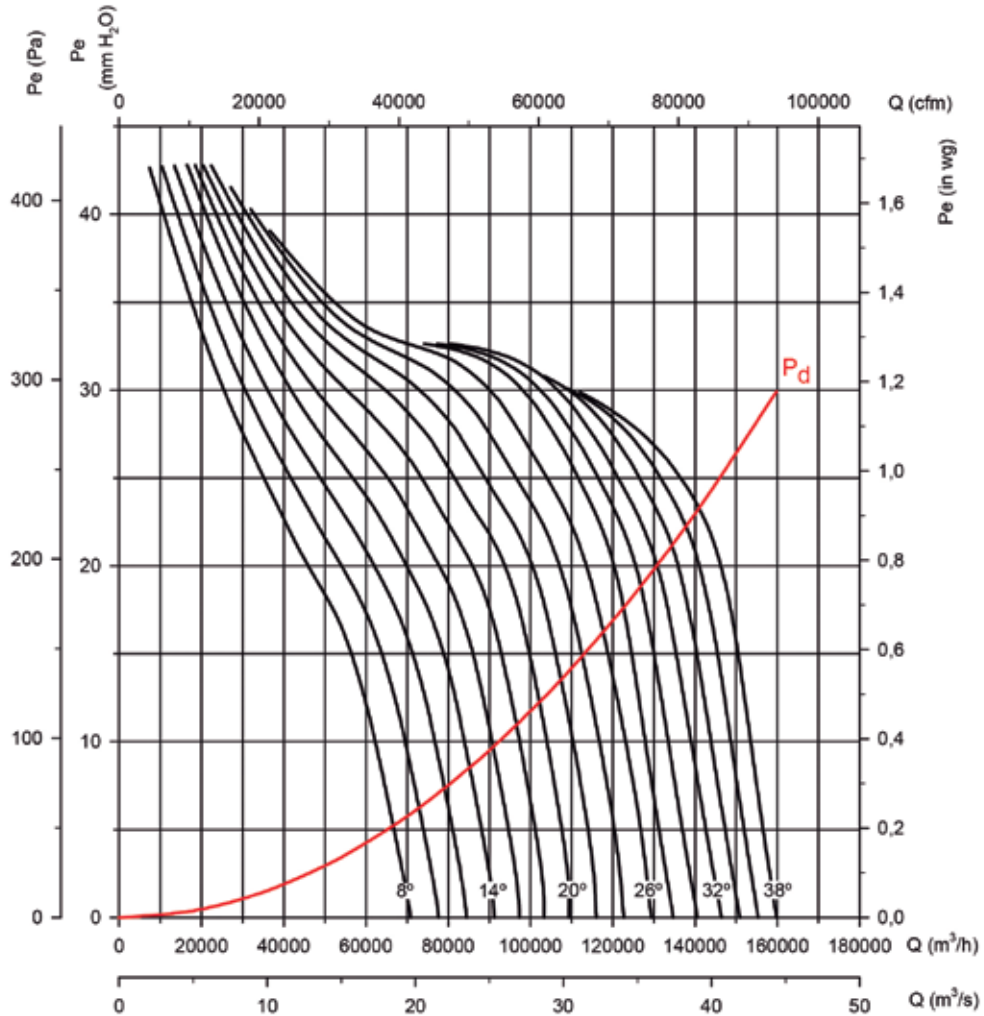

Absorbed power

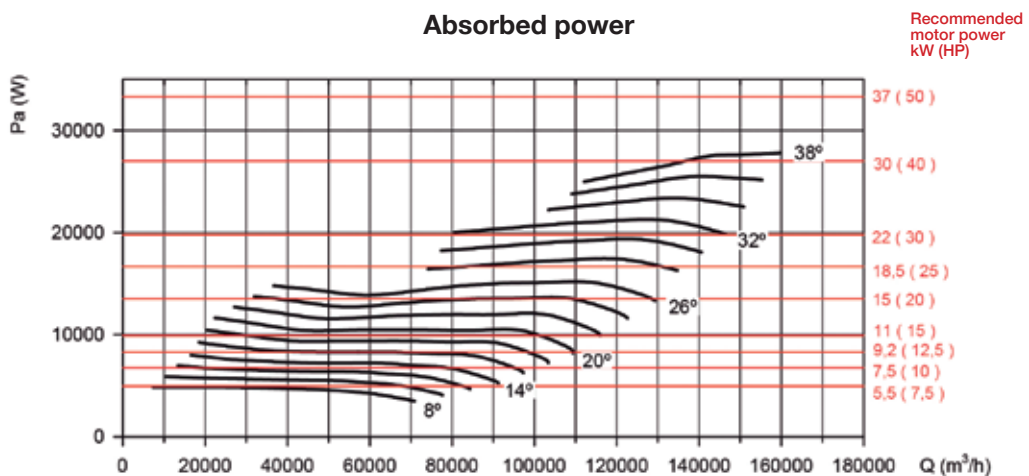

Available features best efficiency point (BEP) at the end of the series.

Characteristic Curves

Q = Airflow in m³/h, m³/s and cfm.

Pe = Static pressure in mmH₂O, Pa and inwg.

Impeller diameter (cm): 160

Number of poles: 8

Number of blades: 9

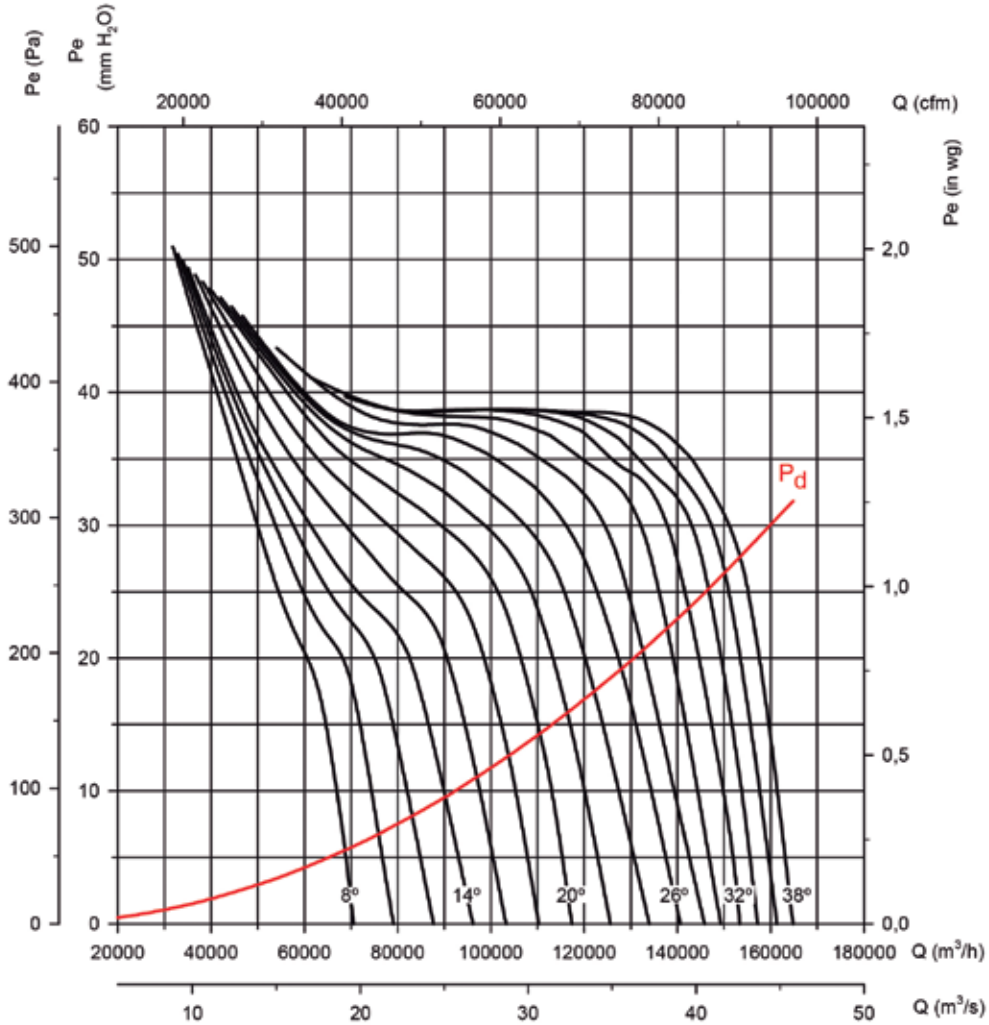

Absorbed power

Recommended motor power kW (HP)

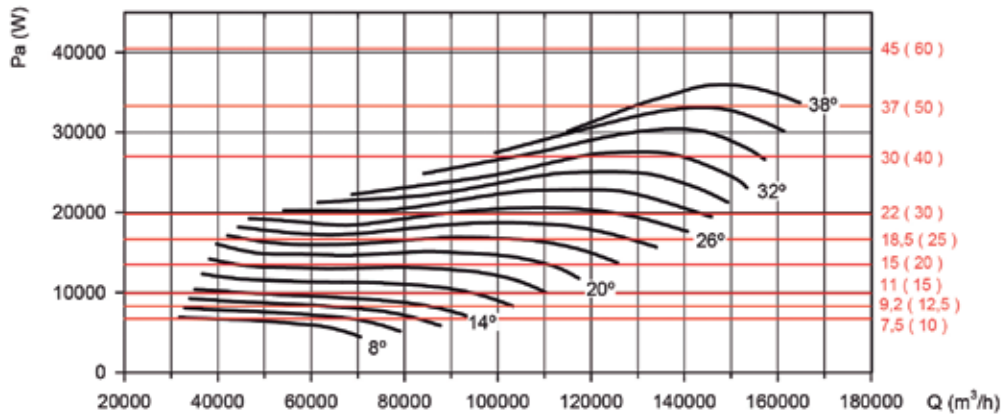

Available features best efficiency point (BEP) at the end of the series.



Erp. BEP (best efficiency point) characteristics

α [°]	Angle of inclination of the blades in degrees	SR	Specific relationship
PN	Motor's nominal power in kW	ηe[%]	Efficiency
MC	Measurement category	N	Degree of efficiency
EC	Efficiency category	[kW]	Electrical power
S	Static	[m³/h]	Airflow
T	Total	[mmH₂O]	Static or total pressure (According to EC)
VSD	Variable-speed drive	[RPM]	Speed

HGT-125-4T/3

α [°]	PN	MC	EC	VSD	SR	ηe [%]	N	[kW]	[m³/h]	[mmH₂O]	[RPM]
8	7.5	C	S	NO	1.00	52.5%	53.3	7.557	41511	35.13	1468
10	11	C	S	NO	1.00	53.7%	54.0	8.917	46792	37.56	1478
12	11	C	S	NO	1.00	54.8%	54.8	10.351	52185	39.90	1474
14	15	C	S	NO	1.01	56.7%	56.7	11.671	57655	42.19	1475
16	15	C	S	NO	1.01	56.1%	55.9	13.387	62205	44.33	1471
18	15	C	S	NO	1.01	55.4%	55.2	15.230	67316	46.06	1467
20	18.5	C	S	NO	1.01	55.1%	54.8	17.092	72427	47.79	1474
22	18.5	C	S	NO	1.01	52.9%	52.4	19.727	77315	49.54	1470
24	22	C	S	NO	1.01	51.6%	51.1	21.959	82218	50.63	1472
26	30	C	S	NO	1.01	52.2%	51.6	24.002	84773	54.27	1485
28	30	C	S	NO	1.01	48.9%	48.3	26.507	90252	52.81	1483
30	30	C	S	NO	1.01	47.0%	46.2	29.132	94744	53.05	1482
32	37	C	S	NO	1.01	45.2%	44.4	31.679	99128	53.03	1484
34	37	B	T	NO	1.01	75.3%	74.4	35.348	116210	84.11	1482
36	37	B	T	NO	1.01	73.7%	72.7	38.587	121252	86.13	1480
38	45	B	T	NO	1.01	73.0%	72.0	41.710	125686	89.03	1478

HGT-125-4T/6

α [°]	PN	MC	EC	VSD	SR	ηe [%]	N	[kW]	[m³/h]	[mmH₂O]	[RPM]
8	15	C	S	NO	1.01	58.5%	58.5	11.665	48508	51.71	1475
10	15	C	S	NO	1.01	57.2%	57.0	14.131	52757	56.25	1470
12	18.5	C	S	NO	1.01	57.3%	57.0	16.358	58230	59.12	1475
14	18.5	C	S	NO	1.01	57.9%	57.5	18.563	63848	61.84	1472
16	22	C	S	NO	1.01	57.5%	57.0	21.282	68837	65.30	1473
18	30	C	S	NO	1.01	57.3%	56.7	23.851	77896	64.43	1485
20	30	C	S	NO	1.01	57.5%	56.8	26.765	80997	69.77	1483
22	37	C	S	NO	1.01	55.6%	54.8	30.364	85910	72.17	1485
24	37	C	S	NO	1.01	54.5%	53.6	34.129	88480	77.19	1483
26	37	C	S	NO	1.01	52.9%	51.9	38.194	93638	79.23	1481
28	45	C	S	NO	1.01	50.1%	49.0	43.550	102038	78.56	1477
30	55	C	S	NO	1.01	47.4%	46.2	48.074	106474	78.56	1483
32	55	C	S	NO	1.01	44.9%	43.7	52.829	110911	78.56	1482
34	75	B	T	NO	1.01	71.5%	70.2	58.224	131496	116.23	1489
36	75	B	T	NO	1.01	71.0%	69.6	63.318	136742	120.78	1488
38	75	B	T	NO	1.01	71.1%	69.7	68.226	142272	125.19	1487

HGT-125-4T/9

α [°]	PN	MC	EC	VSD	SR	ηe [%]	N	[kW]	[m³/h]	[mmH₂O]	[RPM]
8	18.5	C	S	NO	1.01	70.2%	69.9	17.484	37304	120.90	1474
10	18.5	C	S	NO	1.01	62.1%	61.7	20.303	41359	112.05	1470
12	22	C	S	NO	1.01	58.6%	58.0	21.967	50452	93.68	1472
14	22	C	S	NO	1.01	56.8%	56.2	23.247	73859	65.67	1471
16	30	C	S	NO	1.01	54.3%	53.6	27.953	80439	69.38	1483
18	37	C	S	NO	1.01	53.0%	52.2	32.923	87528	73.29	1483
20	37	C	S	NO	1.01	52.5%	51.6	37.906	94456	77.46	1481
22	45	C	S	NO	1.01	51.2%	50.1	42.697	97688	82.16	1478
24	45	C	S	NO	1.01	50.6%	49.5	47.300	101406	86.68	1475
26	55	C	S	NO	1.01	51.3%	50.1	51.728	106241	91.67	1482
28	55	C	S	NO	1.01	49.9%	48.7	57.471	112236	93.94	1480
30	75	C	S	NO	1.01	49.8%	48.5	62.909	120361	95.67	1488
32	75	C	S	NO	1.01	48.8%	47.3	68.406	125253	97.81	1487
34	75	B	T	NO	1.01	75.0%	73.5	75.659	140724	148.06	1486
36	90	B	T	NO	1.01	73.4%	71.8	81.920	145177	152.12	1487
38	90	B	T	NO	1.02	71.2%	69.6	89.259	149120	156.66	1486



Erp. BEP (best efficiency point) characteristics

HGT-125-6T/3

Δ [°]	PN	MC	EC	VSD	SR	ηe [%]	N	[kW]	[m³/h]	[mmH₂O]	[RPM]
8	2.2	C	S	NO	1.00	48.6%	52.7	2.295	27197	15.08	961
10	3	C	S	NO	1.00	49.2%	52.8	2.735	30657	16.12	969
12	3	C	S	NO	1.00	50.2%	53.4	3.175	34190	17.13	964
14	3	C	S	NO	1.00	51.5%	54.3	3.615	37774	18.11	960
16	4	C	S	NO	1.00	51.5%	54.0	4.097	40755	19.03	965
18	4	C	S	NO	1.00	50.9%	53.0	4.661	44104	19.77	960
20	5.5	C	S	NO	1.00	51.9%	53.8	5.105	47452	20.51	980
22	5.5	C	S	NO	1.00	49.8%	51.2	5.892	50654	21.27	977
24	7.5	C	S	NO	1.00	50.4%	51.6	6.394	53010	22.32	981
26	7.5	C	S	NO	1.00	49.6%	50.6	7.121	56526	22.97	979
28	7.5	C	S	NO	1.00	46.9%	47.6	7.859	59317	22.84	977
30	11	C	S	NO	1.00	45.1%	45.6	8.528	62074	22.77	982
32	11	C	S	NO	1.00	43.4%	43.7	9.263	64946	22.76	981
34	11	B	T	NO	1.00	72.4%	72.5	10.336	76138	36.11	979
36	11	B	T	NO	1.00	70.9%	70.9	11.283	79441	36.97	977
38	15	B	T	NO	1.00	70.2%	70.2	12.198	82346	38.21	981

HGT-125-6T/6

Δ [°]	PN	MC	EC	VSD	SR	ηe [%]	N	[kW]	[m³/h]	[mmH₂O]	[RPM]
8	4	C	S	NO	1.00	53.8%	56.6	3.570	31781	22.20	970
10	4	C	S	NO	1.00	52.5%	54.8	4.325	34565	24.14	963
12	5.5	C	S	NO	1.00	53.9%	55.9	4.886	38151	25.38	981
14	5.5	C	S	NO	1.00	54.5%	56.2	5.544	41832	26.55	978
16	7.5	C	S	NO	1.00	55.4%	56.7	6.217	45100	28.03	982
18	7.5	C	S	NO	1.00	54.6%	55.6	7.035	51036	27.66	979
20	7.5	C	S	NO	1.00	54.8%	55.5	7.895	53067	29.95	977
22	11	C	S	NO	1.00	53.5%	53.8	8.879	56286	30.98	982
24	11	C	S	NO	1.00	52.0%	52.1	10.043	57719	33.26	979
26	11	C	S	NO	1.00	50.9%	50.9	11.168	61349	34.01	977
28	15	C	S	NO	1.00	48.2%	48.1	12.737	66852	33.72	981
30	15	C	S	NO	1.00	45.3%	45.1	14.134	69759	33.72	979
32	15	C	S	NO	1.00	42.9%	42.7	15.532	72666	33.72	976
34	18.5	B	T	NO	1.00	67.1%	66.8	17.425	86152	49.89	983
36	18.5	B	T	NO	1.01	66.7%	66.3	18.950	89589	51.84	981
38	18.5	B	T	NO	1.01	66.8%	66.3	20.418	93213	53.74	980

HGT-125-6T/9

Δ [°]	PN	MC	EC	VSD	SR	ηe [%]	N	[kW]	[m³/h]	[mmH₂O]	[RPM]
8	5.5	C	S	NO	1.01	66.1%	67.9	5.222	24441	51.89	979
10	7.5	C	S	NO	1.00	60.5%	61.9	5.867	27097	48.10	983
12	7.5	C	S	NO	1.00	56.4%	57.6	6.417	33055	40.21	981
14	7.5	C	S	NO	1.00	54.7%	55.8	6.791	48390	28.19	980
16	7.5	C	S	NO	1.00	51.8%	52.4	8.245	52702	29.78	976
18	11	C	S	NO	1.00	51.0%	51.1	9.627	57346	31.46	980
20	11	C	S	NO	1.00	50.5%	50.5	11.084	61885	33.25	977
22	15	C	S	NO	1.00	49.2%	49.1	12.487	64003	35.27	981
24	15	C	S	NO	1.00	49.0%	48.8	13.824	65542	37.94	979
26	15	C	S	NO	1.01	49.0%	48.8	15.209	69606	39.35	977
28	18.5	C	S	NO	1.01	47.2%	46.8	17.109	73534	40.32	983
30	18.5	C	S	NO	1.01	46.8%	46.4	18.827	78857	41.07	981
32	18.5	C	S	NO	1.01	45.8%	45.3	20.472	82062	41.98	980
34	22	B	T	NO	1.01	71.0%	70.5	22.466	92199	63.56	981
36	22	B	T	NO	1.01	69.1%	68.5	24.454	95116	65.30	980
38	30	B	T	NO	1.01	68.3%	67.6	26.205	97699	67.25	988



Erp. BEP (best efficiency point) characteristics

HGT-125-8T/3

α [°]	PN	MC	EC	VSD	SR	ηe [%]	N	[kW]	[m³/h]	[mmH₂O]	[RPM]
8	1.1	C	S	NO	1.00	42.3%	48.2	1.150	20612	8.66	716
10	1.5	C	S	NO	1.00	44.2%	49.8	1.325	23235	9.26	720
12	1.5	C	S	NO	1.00	45.1%	50.3	1.538	25912	9.84	715
14	1.5	C	S	NO	1.00	46.3%	51.1	1.751	28629	10.40	710
16	2.2	C	S	NO	1.00	45.8%	50.2	2.008	30888	10.93	719
18	2.2	C	S	NO	1.00	45.2%	49.3	2.285	33426	11.36	715
20	2.2	C	S	NO	1.00	45.0%	48.8	2.561	35964	11.78	710
22	2.2	C	S	NO	1.00	43.2%	46.6	2.955	38311	12.24	704
24	3	C	S	NO	1.00	44.3%	47.5	3.175	38268	13.50	713
26	3	C	S	NO	1.00	43.2%	46.0	3.553	42094	13.38	708
28	4	C	S	NO	1.00	41.5%	44.2	3.859	44508	13.23	719
30	4	C	S	NO	1.00	39.6%	42.0	4.229	46875	13.12	716
32	4	C	S	NO	1.00	38.0%	40.2	4.607	49222	13.07	713
34	4	B	T	NO	1.00	63.4%	65.2	5.141	57704	20.74	709
36	5.5	B	T	NO	1.00	66.9%	68.7	5.205	60208	21.24	730
38	5.5	B	T	NO	1.00	66.4%	68.0	5.620	62409	21.95	728

HGT-125-8T/6

α [°]	PN	MC	EC	VSD	SR	ηe [%]	N	[kW]	[m³/h]	[mmH₂O]	[RPM]
8	1.5	C	S	NO	1.00	47.8%	52.6	1.750	24087	12.75	710
10	2.2	C	S	NO	1.00	46.7%	50.9	2.120	26197	13.87	717
12	2.2	C	S	NO	1.00	46.8%	50.7	2.451	28914	14.58	712
14	3	C	S	NO	1.00	48.9%	52.5	2.692	31704	15.25	719
16	3	C	S	NO	1.00	48.0%	51.2	3.120	34181	16.10	713
18	3	C	S	NO	1.00	47.4%	50.3	3.531	38680	15.89	709
20	4	C	S	NO	1.00	48.3%	50.9	3.897	40219	17.20	719
22	4	C	S	NO	1.00	46.8%	49.1	4.416	42659	17.80	715
24	5.5	C	S	NO	1.00	48.4%	50.5	4.664	45625	18.18	732
26	5.5	C	S	NO	1.00	48.0%	49.8	5.152	46496	19.54	730
28	5.5	C	S	NO	1.00	45.5%	47.0	5.868	50667	19.37	727
30	7.5	C	S	NO	1.00	43.6%	44.8	6.400	52870	19.37	731
32	7.5	C	S	NO	1.00	41.3%	42.3	7.033	55073	19.37	730
34	7.5	B	T	NO	1.00	65.4%	66.1	7.792	65294	28.66	727
36	11	B	T	NO	1.00	65.7%	66.2	8.378	67899	29.78	733
38	11	B	T	NO	1.00	65.8%	66.1	9.027	70645	30.87	732

HGT-125-8T/9

α [°]	PN	MC	EC	VSD	SR	ηe [%]	N	[kW]	[m³/h]	[mmH₂O]	[RPM]
8	2.2	C	S	NO	1.00	57.4%	61.1	2.620	18524	29.81	710
10	3	C	S	NO	1.00	52.5%	55.8	2.945	20537	27.63	716
12	3	C	S	NO	1.00	48.9%	52.0	3.221	25052	23.10	712
14	3	C	S	NO	1.00	47.4%	50.4	3.408	36675	16.19	710
16	4	C	S	NO	1.00	45.7%	48.2	4.070	39942	17.11	718
18	4	C	S	NO	1.00	44.6%	46.7	4.788	43462	18.07	712
20	5.5	C	S	NO	1.00	47.7%	49.5	5.113	46902	19.10	730
22	5.5	C	S	NO	1.00	46.5%	48.0	5.753	48507	20.26	728
24	7.5	C	S	NO	1.00	47.1%	48.4	6.259	49674	21.79	732
26	7.5	C	S	NO	1.00	47.1%	48.2	6.886	52754	22.60	730
28	7.5	C	S	NO	1.00	45.9%	46.7	7.651	55731	23.16	728
30	11	C	S	NO	1.00	46.0%	46.5	8.324	59770	23.52	733
32	11	C	S	NO	1.00	45.1%	45.4	9.051	62194	24.12	732
34	11	B	T	NO	1.00	69.4%	69.5	10.011	69877	36.51	730
36	11	B	T	NO	1.00	67.6%	67.6	10.896	72088	37.51	728
38	15	B	T	NO	1.00	67.1%	67.0	11.609	74046	38.63	733

Erp. BEP (best efficiency point) characteristics
HGT-140-6T/3

α [°]	PN	MC	EC	VSD	SR	ηe [%]	N	[kW]	[m³/h]	[mmH₂O]	[RPM]
8	4	C	S	NO	1.00	43.6%	46.1	3.997	36390	17.60	966
10	5.5	C	S	NO	1.00	45.1%	47.3	4.654	41020	18.81	982
12	5.5	C	S	NO	1.00	46.1%	47.8	5.402	45747	19.99	979
14	5.5	C	S	NO	1.00	47.3%	48.6	6.151	50542	21.13	976
16	7.5	C	S	NO	1.00	48.3%	49.4	6.826	54531	22.20	980
18	7.5	C	S	NO	1.00	47.7%	48.4	7.766	59012	23.07	977
20	11	C	S	NO	1.00	47.9%	48.3	8.639	63492	23.94	982
22	11	C	S	NO	1.00	45.2%	45.2	9.978	68187	24.30	980
24	11	C	S	NO	1.00	44.4%	44.4	11.188	71105	25.65	977
26	15	C	S	NO	1.00	43.9%	43.8	12.396	74264	26.91	981
28	15	C	S	NO	1.00	41.6%	41.4	13.667	77986	26.76	979
30	15	B	T	NO	1.00	65.7%	65.5	15.313	94783	39.00	977
32	15	B	T	NO	1.00	65.9%	65.6	16.576	99158	40.47	975
34	18.5	B	T	NO	1.00	62.5%	62.1	18.463	101655	41.68	982
36	22	B	T	NO	1.00	61.6%	61.1	19.997	106107	42.63	983
38	22	B	T	NO	1.00	61.1%	60.6	21.591	110043	44.01	982

HGT-140-6T/6

α [°]	PN	MC	EC	VSD	SR	ηe [%]	N	[kW]	[m³/h]	[mmH₂O]	[RPM]
8	5.5	C	S	NO	1.00	48.8%	50.1	6.147	42524	25.90	976
10	7.5	C	S	NO	1.00	49.2%	50.1	7.205	46249	28.17	979
12	7.5	C	S	NO	1.00	49.4%	49.9	8.331	51047	29.61	975
14	11	C	S	NO	1.00	50.3%	50.5	9.382	55972	30.98	981
16	11	C	S	NO	1.00	49.4%	49.4	10.874	60345	32.71	978
18	15	C	S	NO	1.00	48.7%	48.6	12.321	68287	32.27	981
20	15	C	S	NO	1.00	48.9%	48.7	13.826	71005	34.95	979
22	15	C	S	NO	1.00	47.3%	47.0	15.667	75312	36.15	976
24	18.5	C	S	NO	1.00	44.8%	44.5	18.064	80549	36.94	982
26	18.5	C	S	NO	1.01	44.0%	43.5	20.023	84172	38.41	980
28	22	C	S	NO	1.01	42.5%	41.9	22.550	89450	39.35	981
30	30	B	T	NO	1.01	62.3%	61.6	24.853	105037	54.13	988
32	30	B	T	NO	1.01	61.1%	60.4	27.311	110368	55.55	987
34	37	B	T	NO	1.01	60.6%	59.8	29.798	114996	57.67	989
36	37	B	T	NO	1.01	60.2%	59.3	32.399	119625	59.87	988
38	37	B	T	NO	1.01	60.2%	59.3	34.907	124508	61.99	987

HGT-140-6T/9

α [°]	PN	MC	EC	VSD	SR	ηe [%]	N	[kW]	[m³/h]	[mmH₂O]	[RPM]
8	11	C	S	NO	1.01	61.0%	61.4	8.837	32703	60.56	982
10	11	C	S	NO	1.01	54.0%	54.0	10.262	36257	56.12	979
12	11	C	S	NO	1.00	50.3%	50.3	11.224	44228	46.93	977
14	11	C	S	NO	1.00	48.8%	48.8	11.878	64747	32.90	976
16	15	C	S	NO	1.00	46.2%	46.0	14.439	70516	34.75	978
18	18.5	C	S	NO	1.00	44.6%	44.2	17.201	76730	36.71	983
20	18.5	C	S	NO	1.01	44.2%	43.7	19.804	82804	38.80	980
22	22	C	S	NO	1.01	43.4%	42.9	22.108	85637	41.15	981
24	22	C	S	NO	1.01	42.9%	42.3	24.492	88897	43.42	979
26	30	C	S	NO	1.01	44.0%	43.3	26.483	93135	45.91	988
28	30	C	S	NO	1.01	43.4%	42.6	29.465	100645	46.65	986
30	30	B	T	NO	1.01	65.7%	64.9	31.785	116137	66.06	985
32	37	B	T	NO	1.01	65.3%	64.4	35.070	119380	70.46	987
34	37	B	T	NO	1.01	63.6%	62.7	38.731	123186	73.50	985
36	45	B	T	NO	1.01	62.6%	61.5	41.746	127100	75.48	987
38	55	B	T	NO	1.01	61.0%	59.9	45.235	130545	77.70	988



Erp. BEP (best efficiency point) characteristics

HGT-140-8T/3

α [°]	PN	MC	EC	VSD	SR	ηe [%]	N	[kW]	[m³/h]	[mmH₂O]	[RPM]
8	2.2	C	S	NO	1.00	38.7%	43.2	1.959	27580	10.11	720
10	2.2	C	S	NO	1.00	39.2%	43.2	2.334	31089	10.81	714
12	2.2	C	S	NO	1.00	40.0%	43.6	2.710	34671	11.48	708
14	3	C	S	NO	1.00	42.4%	45.7	2.987	38306	12.14	715
16	3	C	S	NO	1.00	41.9%	44.8	3.426	41329	12.75	710
18	4	C	S	NO	1.00	42.1%	44.7	3.833	44725	13.25	720
20	4	C	S	NO	1.00	41.9%	44.2	4.297	48120	13.75	716
22	4	C	S	NO	1.00	40.2%	42.1	4.958	51261	14.28	711
24	5.5	C	S	NO	1.00	42.4%	44.3	5.159	53756	14.96	730
26	5.5	C	S	NO	1.00	41.9%	43.5	5.712	56323	15.62	728
28	5.5	C	S	NO	1.00	39.7%	40.9	6.308	59552	15.43	725
30	7.5	B	T	NO	1.00	63.2%	64.2	6.934	71836	22.40	730
32	7.5	B	T	NO	1.00	63.4%	64.2	7.505	75151	23.24	728
34	11	B	T	NO	1.00	61.5%	62.1	8.163	77044	23.94	734
36	11	B	T	NO	1.00	60.2%	60.5	8.910	80418	24.49	732
38	11	B	T	NO	1.00	59.7%	59.8	9.620	83401	25.28	731

HGT-140-8T/6

α [°]	PN	MC	EC	VSD	SR	ηe [%]	N	[kW]	[m³/h]	[mmH₂O]	[RPM]
8	3	C	S	NO	1.00	43.7%	47.1	2.985	32229	14.88	715
10	3	C	S	NO	1.00	42.7%	45.5	3.616	35052	16.18	708
12	4	C	S	NO	1.00	43.6%	46.0	4.112	38688	17.01	717
14	5.5	C	S	NO	1.00	47.5%	49.8	4.328	42421	17.79	733
16	5.5	C	S	NO	1.00	46.6%	48.5	5.017	45735	18.79	731
18	5.5	C	S	NO	1.00	46.0%	47.6	5.677	51754	18.54	728
20	5.5	C	S	NO	1.00	46.2%	47.4	6.370	53815	20.07	725
22	7.5	C	S	NO	1.00	45.5%	46.4	7.094	57078	20.77	729
24	7.5	C	S	NO	1.00	44.1%	44.7	8.060	58997	22.14	727
26	11	C	S	NO	1.00	43.8%	44.1	8.822	62213	22.80	732
28	11	C	S	NO	1.00	41.5%	41.6	10.048	67794	22.60	730
30	11	B	T	NO	1.00	59.8%	59.8	11.260	79607	31.09	727
32	11	B	T	NO	1.00	58.7%	58.6	12.374	83648	31.91	725
34	15	B	T	NO	1.00	59.2%	59.1	13.273	87155	33.13	730
36	15	B	T	NO	1.00	58.8%	58.6	14.432	90663	34.39	728
38	18.5	B	T	NO	1.00	58.3%	58.0	15.688	94364	35.61	731

HGT-140-8T/9

α [°]	PN	MC	EC	VSD	SR	ηe [%]	N	[kW]	[m³/h]	[mmH₂O]	[RPM]
8	4	C	S	NO	1.00	53.4%	55.7	4.396	24785	34.78	715
10	4	C	S	NO	1.00	47.2%	49.1	5.104	27479	32.24	710
12	5.5	C	S	NO	1.00	47.5%	49.3	5.178	33520	26.95	730
14	5.5	C	S	NO	1.00	46.1%	47.7	5.480	49072	18.90	729
16	7.5	C	S	NO	1.00	44.4%	45.6	6.538	53444	19.96	731
18	7.5	C	S	NO	1.00	43.4%	44.1	7.692	58154	21.09	728
20	11	C	S	NO	1.00	43.5%	43.9	8.755	62756	22.29	732
22	11	C	S	NO	1.00	42.4%	42.5	9.851	64904	23.64	730
24	11	C	S	NO	1.00	42.2%	42.2	10.906	66465	25.43	728
26	11	C	S	NO	1.00	42.2%	42.2	11.998	70586	26.37	726
28	15	C	S	NO	1.00	42.1%	42.0	13.034	74569	27.03	730
30	15	B	T	NO	1.00	64.6%	64.4	14.095	87828	38.06	729
32	15	B	T	NO	1.00	63.8%	63.6	15.621	90477	40.47	727
34	18.5	B	T	NO	1.00	61.6%	61.3	17.406	93362	42.22	729
36	22	B	T	NO	1.00	61.9%	61.5	18.369	96329	43.35	738
38	22	B	T	NO	1.00	60.1%	59.6	20.012	98939	44.63	737



Erp. BEP (best efficiency point) characteristics

HGT-160-6T/3

α [°]	PN	MC	EC	VSD	SR	ηe [%]	N	[kW]	[m³/h]	[mmH₂O]	[RPM]
8	7.5	C	S	NO	1.00	46.1%	47.0	7.367	54320	22.98	978
10	11	C	S	NO	1.00	47.0%	47.4	8.712	61231	24.57	982
12	11	C	S	NO	1.00	48.0%	48.1	10.113	68287	26.10	979
14	11	C	S	NO	1.00	49.2%	49.2	11.514	75445	27.60	976
16	15	C	S	NO	1.00	48.6%	48.5	13.224	81399	29.00	980
18	15	C	S	NO	1.00	48.0%	47.8	15.045	88088	30.14	977
20	18.5	C	S	NO	1.00	47.2%	46.9	17.077	94775	31.26	983
22	18.5	C	S	NO	1.00	45.3%	44.9	19.703	100960	32.47	980
24	22	C	S	NO	1.00	44.7%	44.2	21.931	105875	34.02	982
26	22	C	S	NO	1.00	44.2%	43.5	24.285	110931	35.51	980
28	30	C	S	NO	1.00	42.5%	41.8	26.373	117291	35.09	988
30	37	B	T	NO	1.00	66.9%	66.1	29.338	141484	50.94	989
32	37	B	T	NO	1.01	67.1%	66.2	31.756	148014	52.85	988
34	37	B	T	NO	1.01	64.4%	63.5	34.934	151742	54.44	987
36	45	B	T	NO	1.01	63.6%	62.6	37.762	158387	55.68	988
38	45	B	T	NO	1.01	63.0%	62.0	40.772	164263	57.49	987

HGT-160-6T/6

α [°]	PN	MC	EC	VSD	SR	ηe [%]	N	[kW]	[m³/h]	[mmH₂O]	[RPM]
8	11	C	S	NO	1.00	50.8%	50.8	11.508	63476	33.83	976
10	15	C	S	NO	1.00	49.5%	49.4	13.960	69036	36.80	979
12	15	C	S	NO	1.00	49.7%	49.4	16.140	76198	38.68	975
14	18.5	C	S	NO	1.00	49.6%	49.2	18.546	83550	40.46	982
16	22	C	S	NO	1.01	49.1%	48.6	21.327	90077	42.72	982
18	22	C	S	NO	1.01	48.5%	47.9	24.132	101933	42.15	980
20	30	C	S	NO	1.01	49.4%	48.8	26.633	105991	45.64	988
22	30	C	S	NO	1.01	47.9%	47.1	30.181	112419	47.22	986
24	37	C	S	NO	1.01	46.2%	45.3	34.179	120236	48.25	987
26	37	C	S	NO	1.01	44.8%	43.9	37.854	124823	49.92	986
28	45	C	S	NO	1.01	43.9%	42.8	42.584	133523	51.39	987
30	55	B	T	NO	1.01	63.6%	62.4	47.465	156789	70.70	988
32	55	B	T	NO	1.01	62.4%	61.2	52.160	164748	72.55	987
34	75	B	T	NO	1.01	62.2%	61.0	56.552	171656	75.33	993
36	75	B	T	NO	1.01	61.8%	60.5	61.489	178566	78.19	992
38	75	B	T	NO	1.01	61.8%	60.4	66.248	185855	80.97	992

HGT-160-6T/9

α [°]	PN	MC	EC	VSD	SR	ηe [%]	N	[kW]	[m³/h]	[mmH₂O]	[RPM]
8	18.5	C	S	NO	1.01	60.2%	59.8	17.468	48815	79.09	983
10	18.5	C	S	NO	1.01	53.2%	52.8	20.284	54121	73.30	980
12	22	C	S	NO	1.01	50.0%	49.5	22.013	66019	61.29	982
14	22	C	S	NO	1.01	48.5%	47.9	23.296	96649	42.97	980
16	30	C	S	NO	1.01	46.8%	46.0	27.815	105260	45.39	987
18	30	C	S	NO	1.01	45.7%	44.8	32.725	114536	47.95	985
20	37	C	S	NO	1.01	45.5%	44.6	37.471	123602	50.68	986
22	45	C	S	NO	1.01	44.8%	43.8	41.749	127831	53.75	987
24	45	C	S	NO	1.01	44.2%	43.1	46.259	136572	55.04	986
26	55	C	S	NO	1.01	44.9%	43.7	50.577	139024	59.97	987
28	55	C	S	NO	1.01	44.3%	43.0	56.273	150233	60.93	986
30	75	B	T	NO	1.01	67.9%	66.6	59.994	173360	86.28	992
32	75	B	T	NO	1.01	67.1%	65.7	66.557	178199	92.03	992
34	75	B	T	NO	1.01	65.4%	63.9	73.505	183881	96.00	991
36	75	B	T	NO	1.01	63.6%	62.1	80.007	189724	98.58	990
38	90	B	T	NO	1.01	62.2%	60.6	86.518	194865	101.48	991



Erp. BEP (best efficiency point) characteristics

HGT-160-8T/3

α [°]	PN	MC	EC	VSD	SR	ηe [%]	N	[kW]	[m³/h]	[mmH₂O]	[RPM]
8	3	C	S	NO	1.00	40.0%	42.8	3.697	41169	13.20	707
10	4	C	S	NO	1.00	41.2%	43.5	4.333	46407	14.12	716
12	4	C	S	NO	1.00	42.0%	43.9	5.030	51755	14.99	710
14	5.5	C	S	NO	1.00	46.5%	48.2	5.312	57179	15.86	729
16	5.5	C	S	NO	1.00	45.9%	47.3	6.093	61692	16.66	726
18	7.5	C	S	NO	1.00	46.2%	47.3	6.812	66761	17.31	730
20	7.5	C	S	NO	1.00	46.0%	46.7	7.636	71830	17.96	728
22	11	C	S	NO	1.00	44.6%	45.0	8.710	76517	18.65	733
24	11	C	S	NO	1.00	43.7%	43.8	9.772	80242	19.54	730
26	11	C	S	NO	1.00	43.0%	43.1	10.884	85565	20.11	728
28	11	C	S	NO	1.00	40.7%	40.6	12.012	89790	20.00	726
30	15	B	T	NO	1.00	65.5%	65.4	13.035	107486	29.19	730
32	15	B	T	NO	1.00	65.5%	65.4	14.145	112179	30.36	729
34	18.5	B	T	NO	1.00	62.4%	62.1	15.700	115004	31.27	731
36	18.5	B	T	NO	1.00	61.0%	60.6	17.138	120041	31.98	729
38	18.5	B	T	NO	1.00	60.5%	60.1	18.504	124494	33.02	728

HGT-160-8T/6

α [°]	PN	MC	EC	VSD	SR	ηe [%]	N	[kW]	[m³/h]	[mmH₂O]	[RPM]
8	5.5	C	S	NO	1.00	47.9%	49.7	5.309	48108	19.43	729
10	5.5	C	S	NO	1.00	46.8%	48.0	6.432	52322	21.14	725
12	7.5	C	S	NO	1.00	47.8%	48.7	7.308	57750	22.22	729
14	7.5	C	S	NO	1.00	48.3%	48.8	8.293	63322	23.24	726
16	11	C	S	NO	1.00	48.0%	48.2	9.503	68269	24.54	731
18	11	C	S	NO	1.00	47.4%	47.4	10.753	77254	24.21	728
20	11	C	S	NO	1.00	47.5%	47.5	12.067	80330	26.22	726
22	15	C	S	NO	1.00	47.1%	46.9	13.370	85202	27.12	730
24	15	C	S	NO	1.00	45.2%	45.0	15.185	90276	27.95	727
26	18.5	C	S	NO	1.00	44.6%	44.3	16.882	93251	29.67	730
28	18.5	C	S	NO	1.00	42.1%	41.6	19.327	101197	29.52	727
30	22	B	T	NO	1.00	62.6%	62.1	20.999	118830	40.61	737
32	30	B	T	NO	1.00	60.2%	59.6	23.536	124862	41.67	736
34	30	B	T	NO	1.00	59.3%	58.7	25.820	130097	43.27	734
36	30	B	T	NO	1.00	58.9%	58.2	28.074	135334	44.91	733
38	37	B	T	NO	1.00	59.5%	58.7	29.981	140858	46.51	739

HGT-160-8T/9

α [°]	PN	MC	EC	VSD	SR	ηe [%]	N	[kW]	[m³/h]	[mmH₂O]	[RPM]
8	7.5	C	S	NO	1.00	58.6%	59.3	7.811	36997	45.43	727
10	11	C	S	NO	1.00	52.4%	52.7	8.968	41018	42.11	732
12	11	C	S	NO	1.00	48.9%	49.0	9.808	50036	35.21	730
14	11	C	S	NO	1.00	47.4%	47.5	10.380	73250	24.68	729
16	15	C	S	NO	1.00	45.9%	45.9	12.322	79776	26.07	732
18	15	C	S	NO	1.00	44.9%	44.7	14.497	86806	27.54	728
20	15	C	S	NO	1.00	44.5%	44.2	16.691	93677	29.11	725
22	18.5	C	S	NO	1.00	43.0%	42.6	18.948	96883	30.88	727
24	22	C	S	NO	1.00	43.8%	43.3	20.352	100570	32.57	737
26	22	C	S	NO	1.00	44.2%	43.6	22.376	105365	34.45	736
28	30	C	S	NO	1.00	42.6%	42.0	25.367	111878	35.51	735
30	30	B	T	NO	1.00	64.7%	64.0	27.420	131101	49.71	734
32	30	B	T	NO	1.01	64.0%	63.2	30.388	135056	52.86	732
34	30	B	T	NO	1.01	62.3%	61.5	33.561	139362	55.14	730
36	37	B	T	NO	1.01	61.2%	60.3	36.208	143791	56.62	737
38	37	B	T	NO	1.01	59.4%	58.4	39.446	147687	58.29	735

Erp. BEP (best efficiency point) characteristics
HGTX-125-4T/3

α [°]	PN	MC	EC	VSD	SR	η_e [%]	N	[kW]	[m ³ /h]	[mmH ₂ O]	[RPM]
8	7.5	C	S	NO	1.00	51.5%	52.2	7.711	41511	35.13	1467
10	11	C	S	NO	1.00	52.6%	52.9	9.099	46792	37.56	1477
12	11	C	S	NO	1.00	53.7%	53.7	10.562	52185	39.90	1474
14	15	C	S	NO	1.01	55.6%	55.6	11.909	57655	42.19	1474
16	15	C	S	NO	1.01	55.0%	54.8	13.660	62205	44.33	1471
18	15	C	S	NO	1.01	54.3%	54.1	15.540	67316	46.06	1467
20	18.5	C	S	NO	1.01	54.0%	53.7	17.441	72427	47.79	1474
22	22	C	S	NO	1.01	52.4%	51.9	19.912	77315	49.54	1475
24	30	C	S	NO	1.01	51.1%	50.5	22.192	82218	50.63	1486
26	30	C	S	NO	1.01	51.1%	50.5	24.492	84773	54.27	1485
28	30	C	S	NO	1.01	48.0%	47.3	27.048	90252	52.81	1483
30	37	C	S	NO	1.01	46.0%	45.2	29.760	94744	53.05	1485
32	37	C	S	NO	1.01	44.3%	43.4	32.325	99128	53.03	1484
34	37	B	T	NO	1.01	73.8%	72.9	36.069	116210	84.11	1482
36	45	B	T	NO	1.01	72.1%	71.1	39.418	121252	86.13	1479
38	45	B	T	NO	1.01	71.6%	70.5	42.561	125686	89.03	1478

HGTX-125-4T/6

α [°]	PN	MC	EC	VSD	SR	η_e [%]	N	[kW]	[m ³ /h]	[mmH ₂ O]	[RPM]
8	15	C	S	NO	1.01	57.4%	57.3	11.903	48508	51.71	1474
10	15	C	S	NO	1.01	56.0%	55.8	14.419	52757	56.25	1469
12	18.5	C	S	NO	1.01	56.1%	55.8	16.692	58230	59.12	1475
14	22	C	S	NO	1.01	57.4%	57.0	18.738	63848	61.84	1476
16	30	C	S	NO	1.01	56.9%	56.4	21.508	68837	65.30	1487
18	30	C	S	NO	1.01	56.1%	55.5	24.338	77896	64.43	1485
20	30	C	S	NO	1.01	56.3%	55.6	27.311	80997	69.77	1483
22	37	C	S	NO	1.01	54.5%	53.7	30.984	85910	72.17	1484
24	37	C	S	NO	1.01	53.4%	52.5	34.825	88480	77.19	1482
26	45	C	S	NO	1.01	51.8%	50.8	39.017	93638	79.23	1480
28	45	C	S	NO	1.01	49.1%	48.0	44.439	102038	78.56	1477
30	55	C	S	NO	1.01	46.4%	45.3	49.055	106474	78.56	1483
32	55	C	S	NO	1.01	44.0%	42.8	53.907	110911	78.56	1481
34	75	B	T	NO	1.01	70.0%	68.7	59.412	131496	116.23	1489
36	75	B	T	NO	1.01	69.6%	68.2	64.610	136742	120.78	1488
38	75	B	T	NO	1.01	69.6%	68.2	69.618	142272	125.19	1487

HGTX-125-4T/9

α [°]	PN	MC	EC	VSD	SR	η_e [%]	N	[kW]	[m ³ /h]	[mmH ₂ O]	[RPM]
8	18.5	C	S	NO	1.01	68.8%	68.4	17.841	37304	120.90	1473
10	22	C	S	NO	1.01	61.6%	61.1	20.493	41359	112.05	1474
12	30	C	S	NO	1.01	58.0%	57.4	22.200	50452	93.68	1486
14	30	C	S	NO	1.01	56.2%	55.6	23.494	73859	65.67	1485
16	30	C	S	NO	1.01	53.3%	52.5	28.523	80439	69.38	1482
18	37	C	S	NO	1.01	52.0%	51.1	33.595	87528	73.29	1483
20	45	C	S	NO	1.01	51.4%	50.5	38.723	94456	77.46	1480
22	45	C	S	NO	1.01	50.2%	49.1	43.568	97688	82.16	1477
24	55	C	S	NO	1.01	49.8%	48.7	48.010	101406	86.68	1483
26	55	C	S	NO	1.01	50.2%	49.0	52.784	106241	91.67	1482
28	75	C	S	NO	1.01	49.2%	47.9	58.335	112236	93.94	1489
30	75	C	S	NO	1.01	48.8%	47.5	64.192	120361	95.67	1488
32	75	C	S	NO	1.01	47.8%	46.3	69.802	125253	97.81	1487
34	90	B	T	NO	1.01	73.9%	72.4	76.797	140724	148.06	1488
36	90	B	T	NO	1.01	71.9%	70.3	83.592	145177	152.12	1487
38	90	B	T	NO	1.02	69.8%	68.2	91.080	149120	156.66	1486



Erp. BEP (best efficiency point) characteristics

HGTX-125-6T/3

α [°]	PN	MC	EC	VSD	SR	ηe [%]	N	[kW]	[m³/h]	[mmH₂O]	[RPM]
8	3	C	S	NO	1.00	46.2%	50.1	2.418	27197	15.08	973
10	3	C	S	NO	1.00	46.9%	50.3	2.870	30657	16.12	968
12	3	C	S	NO	1.00	48.0%	51.1	3.318	34190	17.13	963
14	4	C	S	NO	1.00	50.1%	52.8	3.720	37774	18.11	968
16	4	C	S	NO	1.00	49.7%	52.1	4.247	40755	19.03	964
18	5.5	C	S	NO	1.00	50.5%	52.6	4.697	44104	19.77	981
20	5.5	C	S	NO	1.00	50.6%	52.4	5.239	47452	20.51	979
22	7.5	C	S	NO	1.00	50.4%	51.9	5.817	50654	21.27	983
24	7.5	C	S	NO	1.00	49.4%	50.6	6.524	53010	22.32	981
26	7.5	C	S	NO	1.00	48.6%	49.5	7.266	56526	22.97	978
28	11	C	S	NO	1.00	46.3%	47.0	7.959	59317	22.84	984
30	11	C	S	NO	1.00	44.2%	44.6	8.702	62074	22.77	982
32	11	C	S	NO	1.00	42.6%	42.8	9.452	64946	22.76	981
34	11	B	T	NO	1.00	71.0%	71.0	10.547	76138	36.11	978
36	15	B	T	NO	1.00	69.4%	69.3	11.528	79441	36.97	982
38	15	B	T	NO	1.00	68.8%	68.7	12.447	82346	38.21	981

HGTX-125-6T/6

α [°]	PN	MC	EC	VSD	SR	ηe [%]	N	[kW]	[m³/h]	[mmH₂O]	[RPM]
8	4	C	S	NO	1.00	51.7%	54.4	3.718	31781	22.20	968
10	5.5	C	S	NO	1.00	52.0%	54.3	4.371	34565	24.14	983
12	5.5	C	S	NO	1.00	52.5%	54.4	5.024	38151	25.38	980
14	5.5	C	S	NO	1.00	53.3%	54.9	5.668	41832	26.55	978
16	7.5	C	S	NO	1.00	54.2%	55.5	6.344	45100	28.03	981
18	7.5	C	S	NO	1.00	53.5%	54.5	7.179	51036	27.66	979
20	11	C	S	NO	1.00	54.1%	54.7	7.995	53067	29.95	984
22	11	C	S	NO	1.00	52.4%	52.7	9.060	56286	30.98	981
24	11	C	S	NO	1.00	51.0%	51.1	10.248	57719	33.26	979
26	11	C	S	NO	1.00	49.8%	49.8	11.396	61349	34.01	977
28	15	C	S	NO	1.00	47.2%	47.1	12.996	66852	33.72	980
30	15	C	S	NO	1.00	44.4%	44.2	14.423	69759	33.72	978
32	18.5	C	S	NO	1.00	41.6%	41.3	16.048	72666	33.72	984
34	18.5	B	T	NO	1.00	65.8%	65.4	17.781	86152	49.89	982
36	22	B	T	NO	1.01	65.9%	65.5	19.186	89589	51.84	984
38	22	B	T	NO	1.01	66.0%	65.5	20.673	93213	53.74	983

HGTX-125-6T/9

α [°]	PN	MC	EC	VSD	SR	ηe [%]	N	[kW]	[m³/h]	[mmH₂O]	[RPM]
8	5.5	C	S	NO	1.01	64.5%	66.2	5.354	24441	51.89	979
10	7.5	C	S	NO	1.00	59.3%	60.7	5.987	27097	48.10	982
12	7.5	C	S	NO	1.00	55.3%	56.4	6.548	33055	40.21	981
14	7.5	C	S	NO	1.00	53.6%	54.6	6.930	48390	28.19	979
16	11	C	S	NO	1.00	51.2%	51.7	8.350	52702	29.78	983
18	11	C	S	NO	1.00	50.0%	50.1	9.823	57346	31.46	980
20	15	C	S	NO	1.00	49.5%	49.4	11.325	61885	33.25	983
22	15	C	S	NO	1.00	48.2%	48.1	12.742	64003	35.27	981
24	15	C	S	NO	1.00	48.0%	47.8	14.106	65542	37.94	979
26	15	C	S	NO	1.01	48.0%	47.8	15.519	69606	39.35	976
28	18.5	C	S	NO	1.01	46.2%	45.9	17.458	73534	40.32	983
30	18.5	C	S	NO	1.01	45.9%	45.5	19.211	78857	41.07	981
32	22	C	S	NO	1.01	45.2%	44.8	20.727	82062	41.98	983
34	22	B	T	NO	1.01	69.6%	69.0	22.925	92199	63.56	981
36	30	B	T	NO	1.01	68.9%	68.3	24.541	95116	65.30	989
38	30	B	T	NO	1.01	66.9%	66.2	26.740	97699	67.25	988



Erp. BEP (best efficiency point) characteristics

HGTX-125-8T/3

α [°]	PN	MC	EC	VSD	SR	ηe [%]	N	[kW]	[m³/h]	[mmH₂O]	[RPM]
8	1.1	C	S	NO	1.00	39.7%	45.5	1.223	20612	8.66	713
10	1.5	C	S	NO	1.00	41.6%	47.0	1.409	23235	9.26	718
12	1.5	C	S	NO	1.00	42.5%	47.5	1.633	25912	9.84	713
14	2.2	C	S	NO	1.00	43.7%	48.3	1.856	28629	10.40	721
16	2.2	C	S	NO	1.00	43.3%	47.5	2.125	30888	10.93	717
18	2.2	C	S	NO	1.00	42.8%	46.8	2.412	33426	11.36	713
20	3	C	S	NO	1.00	44.2%	47.9	2.611	35964	11.78	719
22	3	C	S	NO	1.00	42.5%	45.8	3.003	38311	12.24	715
24	3	C	S	NO	1.00	42.3%	45.3	3.325	38268	13.50	711
26	4	C	S	NO	1.00	42.0%	44.8	3.649	42094	13.38	721
28	4	C	S	NO	1.00	39.9%	42.4	4.017	44508	13.23	718
30	4	C	S	NO	1.00	38.1%	40.4	4.390	46875	13.12	715
32	5.5	C	S	NO	1.00	39.6%	41.9	4.421	49222	13.07	733
34	5.5	B	T	NO	1.00	66.3%	68.3	4.912	57704	20.74	731
36	5.5	B	T	NO	1.00	65.2%	66.9	5.341	60208	21.24	729
38	5.5	B	T	NO	1.00	64.9%	66.4	5.746	62409	21.95	728

HGTX-125-8T/6

α [°]	PN	MC	EC	VSD	SR	ηe [%]	N	[kW]	[m³/h]	[mmH₂O]	[RPM]
8	2.2	C	S	NO	1.00	45.1%	49.7	1.855	24087	12.75	721
10	2.2	C	S	NO	1.00	44.1%	48.3	2.241	26197	13.87	715
12	2.2	C	S	NO	1.00	44.4%	48.1	2.584	28914	14.58	710
14	3	C	S	NO	1.00	46.5%	50.0	2.831	31704	15.25	717
16	3	C	S	NO	1.00	45.8%	48.9	3.270	34181	16.10	712
18	4	C	S	NO	1.00	46.1%	48.9	3.627	38680	15.89	721
20	4	C	S	NO	1.00	46.4%	48.9	4.056	40219	17.20	718
22	4	C	S	NO	1.00	45.2%	47.3	4.576	42659	17.80	714
24	5.5	C	S	NO	1.00	47.0%	49.0	4.809	45625	18.18	731
26	5.5	C	S	NO	1.00	46.7%	48.5	5.289	46496	19.54	729
28	5.5	C	S	NO	1.00	44.6%	46.0	5.988	50667	19.37	727
30	7.5	C	S	NO	1.00	42.7%	43.9	6.531	52870	19.37	731
32	7.5	C	S	NO	1.00	40.5%	41.4	7.176	55073	19.37	729
34	7.5	B	T	NO	1.00	64.1%	64.7	7.951	65294	28.66	727
36	11	B	T	NO	1.00	64.4%	64.8	8.549	67899	29.78	733
38	11	B	T	NO	1.00	64.4%	64.7	9.211	70645	30.87	732

HGTX-125-8T/9

α [°]	PN	MC	EC	VSD	SR	ηe [%]	N	[kW]	[m³/h]	[mmH₂O]	[RPM]
8	3	C	S	NO	1.00	56.3%	59.9	2.670	18524	29.81	719
10	3	C	S	NO	1.00	50.0%	53.2	3.090	20537	27.63	714
12	3	C	S	NO	1.00	46.7%	49.7	3.372	25052	23.10	711
14	4	C	S	NO	1.00	46.1%	49.0	3.505	36675	16.19	722
16	4	C	S	NO	1.00	44.0%	46.4	4.230	39942	17.11	716
18	5.5	C	S	NO	1.00	46.6%	48.8	4.588	43462	18.07	732
20	5.5	C	S	NO	1.00	46.4%	48.2	5.251	46902	19.10	730
22	5.5	C	S	NO	1.00	45.5%	47.0	5.875	48507	20.26	727
24	7.5	C	S	NO	1.00	46.1%	47.4	6.387	49674	21.79	731
26	7.5	C	S	NO	1.00	46.2%	47.2	7.027	52754	22.60	730
28	7.5	C	S	NO	1.00	45.0%	45.7	7.807	55731	23.16	727
30	11	C	S	NO	1.00	45.1%	45.5	8.493	59770	23.52	733
32	11	C	S	NO	1.00	44.2%	44.4	9.236	62194	24.12	732
34	11	B	T	NO	1.00	68.0%	68.0	10.215	69877	36.51	730
36	11	B	T	NO	1.00	66.2%	66.2	11.119	72088	37.51	728
38	15	B	T	NO	1.00	65.7%	65.7	11.845	74046	38.63	732

Accessories

See accessories section.



INT

AR

VSD3/A-RFT
VSD1/A-RFM

CUADROS

RT

PT/H

BTUB

BAC

PS

S

SI

PV

HTM



Mobile long-cased axial fans

Mobile fans with possibility of directing airflow.



Fan:

- Sheet steel cased casing
- Impeller in polyamide 6 reinforced with fibre glass
- Protection guard to prevent contacts according to standard UNE-EN ISO 12499:2010 on both sides
- Connection box with start-stop switch that can be rearmed manually to prevent the fan being switched on accidentally (EN ISO 12100:2012)
- Airflow direction from motor to impeller

Motor:

- IE2 efficiency motors for capacities equal to or over 0.75kW and below 7.5kW, except single-phase, 2 speed and 8 pole motors.
- Class F motors, with ball bearings and IP55 protection, except single-phase versions from size 35 to size 56, IP54 protection.
- Single-phase 230V.-50Hz., and three-phase 230/400V.-50Hz.
- Fan working temperature: -25°C + 50°C

Finish:

- Anticorrosive finish in polyester resin polymerised at 190°C, after degreasing with phosphate-free nanotechnology treatment.

On request:

- Airflow direction from impeller to motor
- 100% reversible impellers.
- Special windings for different voltages
- ATEX certification, Category 2

Order code

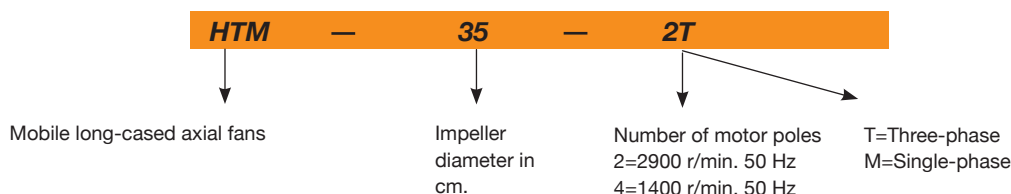

Technical characteristics

Model	Speed (r/min)	Max. current admissible (A)		Installed capacity (kW)	Maximum airflow (m³/h)	Sound pressure level dB(A)	Approx. weight (Kg)
		230V	400V				
HTM-35-2T	2710	1.92	1.11	0.37	5750	77	13
HTM-35-2M	2780	2.53		0.37	5750	77	13
HTM-35-4T	1320	0.65	0.38	0.09	3100	59	12
HTM-35-4M	1380	0.65		0.09	3100	59	12
HTM-40-4T	1350	1.66	0.96	0.25	5150	64	19
HTM-40-4M	1370	2		0.25	5150	64	19
HTM-45-4T	1370	2.02	1.17	0.37	7100	68	22
HTM-45-4M	1400	2.76		0.37	7100	68	22
HTM-56-4T	1380	2.92	1.69	0.55	11050	72	27
HTM-56-4M	1400	4.4		0.55	11050	72	27
HTM-63-4T	1400	4.03	2.32	1.1	17000	74	35



Erp. BEP (best efficiency point) characteristics

MC	Measurement category	ηe[%]	Efficiency
EC	Efficiency category	N	Degree of efficiency
S	Static	[kW]	Electrical power
T	Total	[m³/h]	Airflow
VSD	Variable-speed drive	[mmH₂O]	Static or total pressure (According to EC)
SR	Specific relationship	[RPM]	Speed

Model	MC	EC	VSD	SR	ηe [%]	N	[kW]	[m3/h]	[mmH₂O]	[RPM]
HTM-35-2T	A	S	NO	1.00	37.1%	45.2	0.515	2998	23.40	2737
HTM-35-2M	A	S	NO	1.00	36.5%	44.6	0.524	2983	23.52	2791
HTM-35-4T	A	S	NO	1.00	27.4%	39.3	0.128	1857	6.94	1400
HTM-35-4M	A	S	NO	1.00	25.6%	37.4	0.137	1851	6.96	1425
HTM-40-4T	A	S	NO	1.00	32.0%	41.7	0.289	3401	10.00	1396
HTM-40-4M	A	S	NO	1.00	28.2%	37.5	0.329	3332	10.23	1401
HTM-45-4T	A	S	NO	1.00	33.4%	41.8	0.475	4228	13.80	1392
HTM-45-4M	A	S	NO	1.00	29.6%	37.6	0.538	4257	13.73	1410
HTM-56-4T	A	S	NO	1.00	33.2%	40.6	0.660	6808	11.81	1405
HTM-56-4M	A	S	NO	1.00	32.7%	40.1	0.669	6622	12.13	1422
HTM-63-4T	C	S	NO	1.00	45.3%	51.1	1.179	10593	18.50	1412

Acoustic features

The specified values are determined according to free field measurements of pressure and sound levels in dB(A) at an equivalent distance of twice the fan's span plus the impeller's diameter, with a minimum of 1.5 m.

Sound power Lw(A) spectrum in dB(A) via frequency band in Hz.

Model	63	125	250	500	1000	2000	4000	8000	Model	63	125	250	500	1000	2000	4000	8000
35-2	42	59	71	79	84	84	80	73	45-4	33	50	62	70	75	75	71	64
35-4	24	41	53	61	66	66	62	55	56-4	39	56	69	76	81	82	77	70
40-4	29	46	58	66	71	71	67	60	63-4	43	60	73	80	85	86	81	74

Dimensions in mm

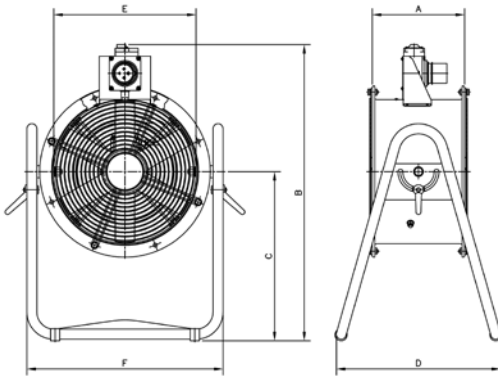

Model	A	B	C	D	E	F
HTM-35	280	736	420	415	355	489
HTM-40	320	775	481	450	410	596
HTM-45	360	795	481	453	460	596
HTM-56	400	945	594	522	560	726
HTM-63	430	978	594	522	640	805

Characteristics of jet with fan positioned 1 metre away from point 0

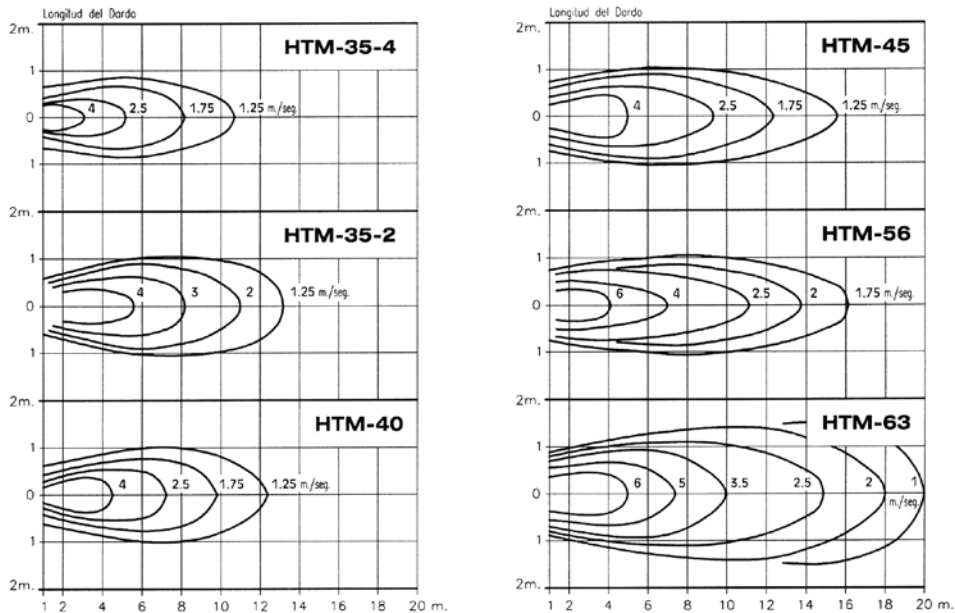

Accessories

See accessories section.



HPX



Long cased axial fans with external motor

Long cased belt-driven axial fans with casing opening up to 180°.



Fan:

- Long casing with sheet steel twist-lock cap.
- Impellers made from cast aluminium
- Sealed transmission unit (IP66) with double retention system
- Airflow direction from motor to impeller
- Temperature of the air to transport: -25°C +120°C

Motor:

- IE2 efficiency motors for capacities equal to or over 0.75kW and below 7.5kW, except single-phase, 2 speed and 8 pole motors.
- IE3 efficiency motors for capacities equal to or over 7.5kW, except single-phase, 2 speed and 8 pole motors.
- Class F motors, with ball bearings, IP55 protection.
- Single-phase 230V-50Hz and three-phase 230/400V-50Hz (up to 4kW) and 400/690V-50Hz (power over 4kW)

Finish:

- Anticorrosive finish in polyester resin polymerised at 190°C, after degreasing with phosphate-free nanotechnology treatment.

On request:

- IE2 and IE3 efficiency motors for any power.
- Airflow direction from impeller to motor
- 100% reversible impellers.
- Special windings for different voltages
- ATEX Certification, category 2 (see HPX/ATEX series)

Order code

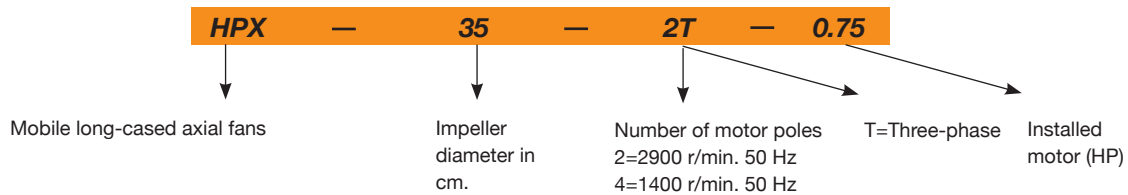

Technical characteristics

Model	Speed (r/min)	Max. current admissible (A)			Installed capacity (kW)	Maximum airflow (m³/h)	Sound pressure level dB(A)	Approx. weight (Kg)
		230V	400V	690V				
HPX-35-2T-0.75	2720	2.57	1.49		0.55	4750	77	22
HPX-35-4T-0.33	1420	1.66	0.96		0.25	2500	60	20
HPX-45-4T-0.33	1200	1.66	0.96		0.25	6300	69	32
HPX-45-4T-0.50	1420	2.02	1.17		0.37	6600	70	35.5
HPX-50-4T-0.75	1310	2.92	1.69		0.55	9000	70	32.5
HPX-50-4T-1	1500	3.10	1.79		0.75	10800	71	34
HPX-56-4T-0.75	1380	2.92	1.69		0.55	11300	72	35.5
HPX-56-4T-1	1420	3.10	1.79		0.75	12200	73	35.5
HPX-56-4T-1.5	1420	4.03	2.32		1.1	14500	75	39
HPX-63-4T-1.5	1300	4.03	2.32		1.1	16000	74	59
HPX-63-4T-2	1420	5.96	3.44		1.5	17500	78	63
HPX-71-4T-1.5	1200	4.03	2.32		1.1	20300	78	73.5
HPX-71-4T-2	1350	5.96	3.44		1.5	22500	79	76.8
HPX-71-4T-3	1450	8.36	4.83		2.2	24000	81	85.2
HPX-80-4T-3	1200	8.36	4.83		2.2	29000	83	95
HPX-80-4T-4	1350	10.96	6.33		3	32000	84	100
HPX-80-4T-5.5	1450	14.10	8.12		4	40500	84	106
HPX-90-4T-5.5	1280	14.10	8.12		4	44000	89	118
HPX-90-4T-7.5	1400		11.60	6.72	5.5	51000	91	132
HPX-100-4T-10 IE3	1450		13.90	8.06	7.5	63000	93	175
HPX-100-4T-15 IE3	1450		20.90	12.10	11	68000	94	206

Acoustic features

The specified values are determined according to free field measurements of pressure and sound levels in dB(A) at an equivalent distance of twice the fan's span plus the impeller's diameter, with a minimum of 1.5 m.

Sound power Lw(A) spectrum in dB(A) via frequency band in Hz.

Model	63	125	250	500	1000	2000	4000	8000	Model	63	125	250	500	1000	2000	4000	8000
35-2-0.75	48	63	82	81	82	81	76	67	71-4-1.5	55	75	83	88	90	87	80	69
35-4-0.33	31	46	65	64	65	64	59	50	74-4-2	56	76	84	89	91	88	81	70
45-4-0.33	40	55	74	73	74	73	68	59	71-4-3	65	76	86	92	93	88	77	73
45-4-0.50	41	56	75	74	75	74	69	60	80-4-3	60	80	88	93	95	92	85	74
50-4-0.75	44	58	77	77	78	76	72	63	80-4-4	61	81	89	94	96	93	86	75
50-4-1	45	59	78	78	79	77	73	64	80-4-5.5	68	79	89	95	96	91	80	76
56-4-0.75	47	67	75	80	82	79	72	61	90-4-5.5	67	88	95	100	103	99	92	81
56-4-1	48	68	76	81	83	80	73	62	90-4-7.5	69	90	97	102	105	101	94	83
56-4-1.5	57	68	78	84	85	80	69	65	100-4-10	73	93	101	106	108	105	98	87
63-4-1.5	51	71	79	84	86	83	76	65	100-4-15	74	94	102	107	109	106	99	88
63-4-2	62	73	83	89	90	85	74	70									

Dimensions in mm

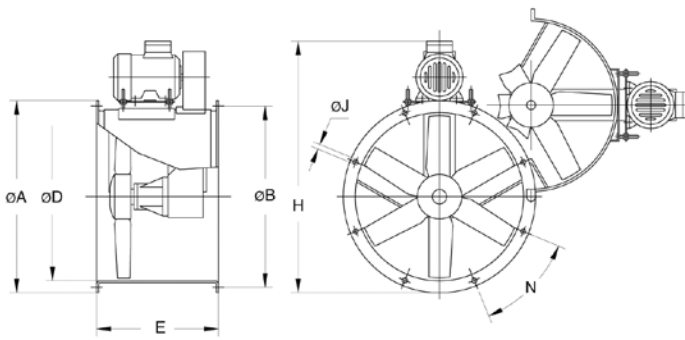

Model	ØA	ØB	ØD	E	H	ØJ	N
HPX-35-2T-0.75	425	395	355	380	606	10	8x45°
HPX-35-4T-0.33	425	395	355	380	609	10	8x45°
HPX-45-4T-0.33	540	500	460	420	740	12	8x45°
HPX-45-4T-0.50	540	500	460	420	728	12	8x45°
HPX-50-4T-0.75	600	560	512	420	803	12	12x30°
HPX-50-4T-1	600	560	512	420	803	12	12x30°
HPX-56-4T-0.75	660	620	560	450	848	12	12x30°
HPX-56-4T-1	660	620	560	450	848	12	12x30°
HPX-56-4T-1.5	660	620	560	450	870	12	12x30°
HPX-63-4T-1.5	730	690	640	500	950	12	12x30°
HPX-63-4T-2	730	690	640	500	950	12	12x30°
HPX-71-4T-1.5	810	770	710	550	1017	12	16x22°30'
HPX-71-4T-2	810	770	710	550	1017	12	16x22°30'
HPX-71-4T-3	810	770	710	550	1035	12	16x22°30'
HPX-80-4T-3	900	860	800	600	1173	12	16x22°30'
HPX-80-4T-4	900	860	800	600	1173	12	16x22°30'
HPX-80-4T-5.5	900	860	800	600	1200	12	16x22°30'
HPX-90-4T-5.5	1015	970	900	650	1320	15	16x22°30'
HPX-90-4T-7.5	1015	970	900	650	1320	15	16x22°30'
HPX-100-4T-10	1115	1070	1000	750	1483	15	16x22°30'
HPX-100-4T-15	1115	1070	1000	750	1513	15	16x22°30'

Characteristic Curves

Q = Airflow in m³/h, m³/s and cfm.

Pe = Static pressure in mmH₂O, Pa and inwg.

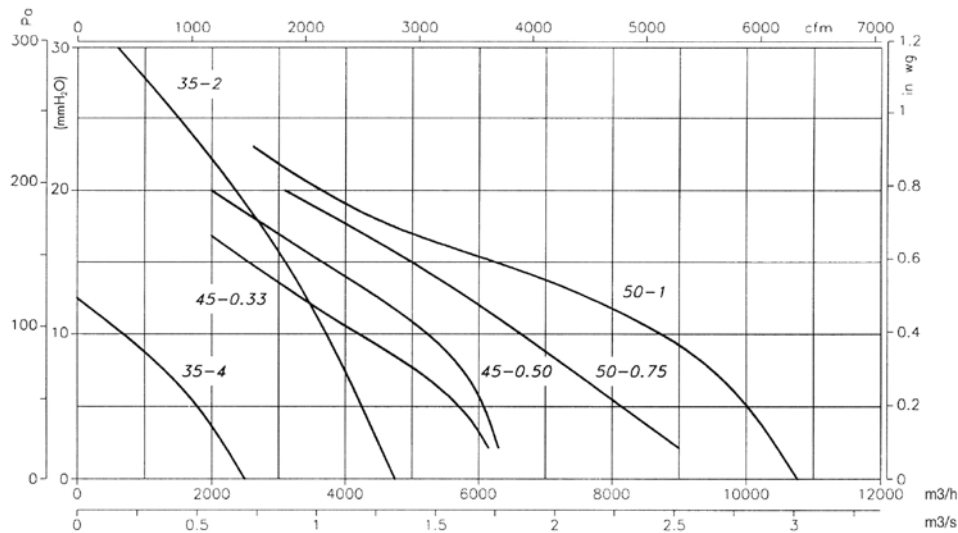

Characteristic Curves

Q = Airflow in m³/h, m³/s and cfm.

Pe= Static pressure in mmH₂O, Pa and inwg.

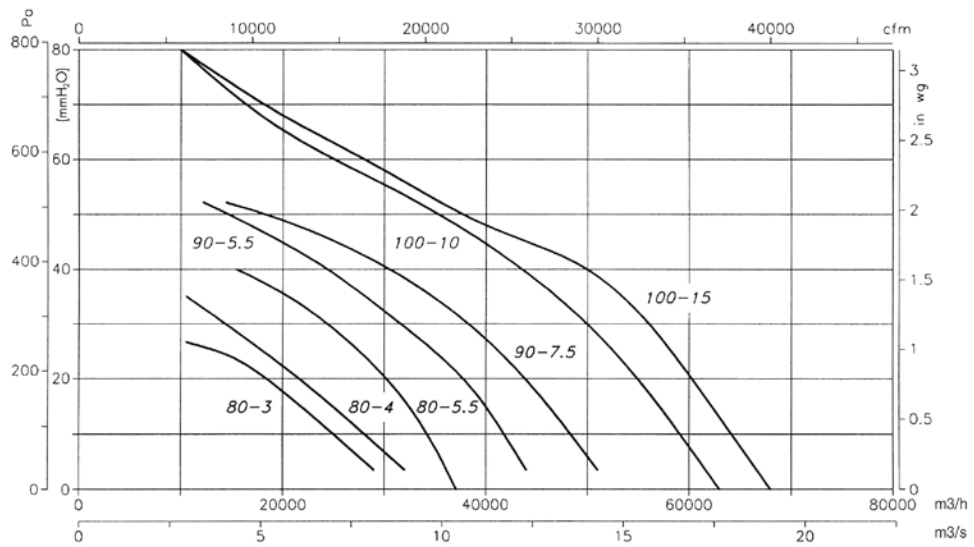
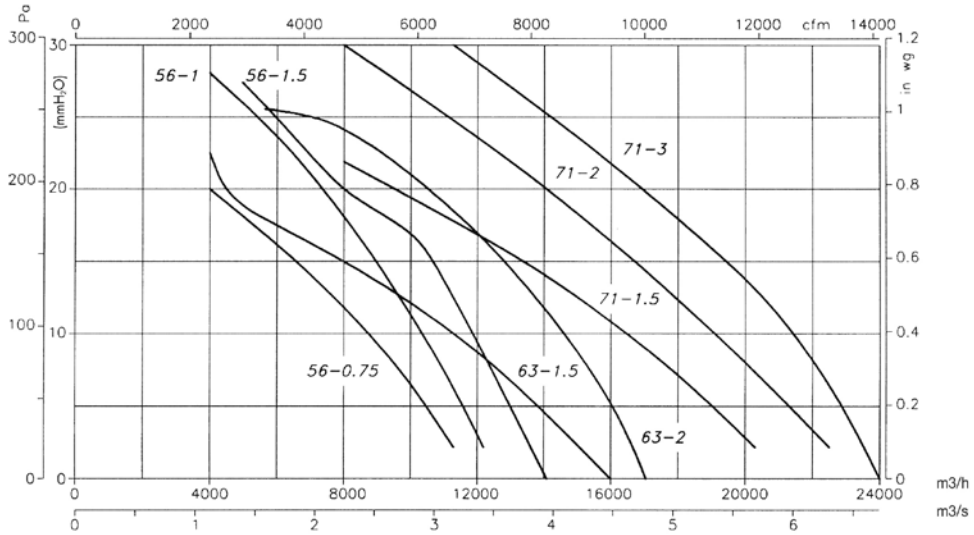

Accessories

See accessories section.

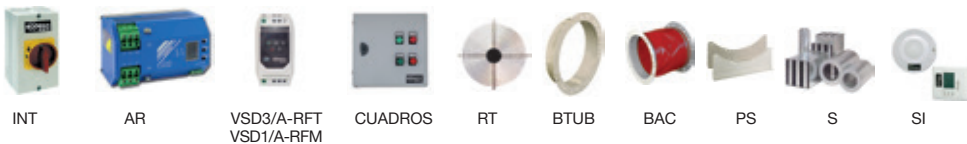

HBA

Forked cased axial fans with motor outside the air flow



Forked cased fans for moving air of up to 150°C continuously and up to 200°C sporadically.

Fan:

- Sheet steel cased casing
- Impeller made from cast aluminium
- Airflow direction from impeller to motor

Motor:

- IE2 efficiency motors for capacities equal to or over 0.75kW and below 7.5kW, except single-phase, 2 speed and 8 pole motors.
- Class F motors, with ball bearings, IP-55 protection
- Three-phase 230/400V-50Hz. (up to 4kW) and 400/690V-50Hz. (power over 4kW)
- Fan working temperature: -25°C + 150°C

Finish:

- Anticorrosive with heat-protection paint for working in hot environments.

On request:

- Casing made from stainless steel
- Hot galvanised finish
- Special windings for different voltages and motors with PTC

Order code

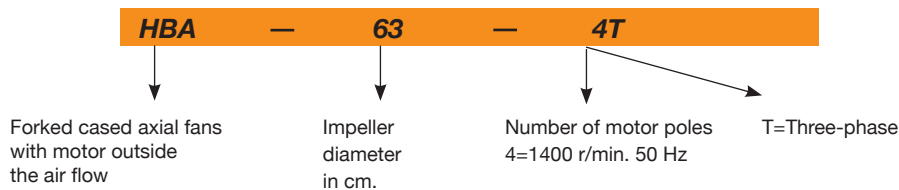

Technical characteristics

Model	Speed (r/min)	Max. current admissible (A)		Installed capacity (kW)	Maximum airflow (m³/h)	Sound pressure level dB(A)	Approx. weight (Kg)
		230V	400V				
HBA-31-2T	2760	2.57	1.49	0.55	2900	77	25
HBA-31-2M	2810	3.49	-	0.55	2900	77	26
HBA-31-4T	1350	1.66	0.96	0.25	1600	66	24
HBA-31-4M	1370	2.00	-	0.25	1600	66	25
HBA-40-2T	2860	4.20	2.40	1.10	6200	82	45
HBA-40-2M	2820	6.51	-	1.10	6200	82	46
HBA-40-4T	1370	2.02	1.17	0.37	3200	75	40
HBA-45-2T	2900	10.18	5.88	3.00	8550	84	57
HBA-50-4T	1410	3.10	1.79	0.75	6750	76	73
HBA-63-4T	1400	4.03	2.32	1.10	11150	77	91
HBA-71-4T	1440	14.10	8.12	4.00	15850	79	164
HBA-71-6T	900	2.99	1.73	0.55	11200	74	140
HBA-80-6T	945	4.88	2.82	1.10	14900	77	190
HBA-100-6T	945	4.88	2.82	1.10	21700	80	260

Accessories

See accessories section.

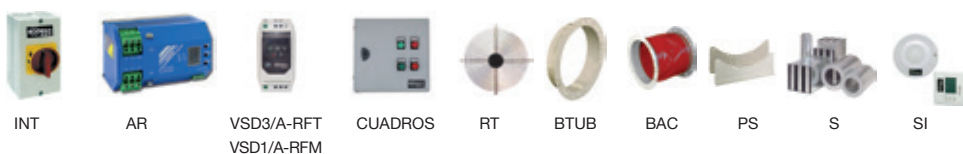

Dimensions in mm

HBA-31...50

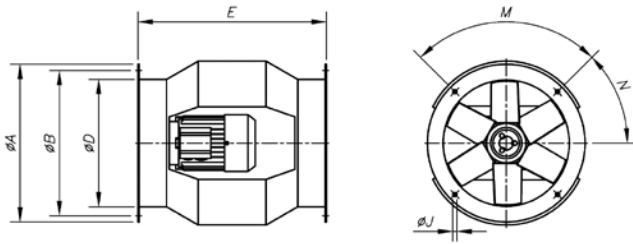

HBA-63...100

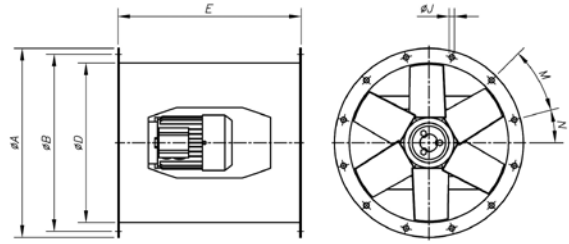

Model	ØA	ØB	ØD	E	ØJ	M	N
HBA-31	385	355	308	460	10	4x90°	45°
HBA-40	490	450	410	580	12	8x45°	22.5°
HBA-45	540	500	460	640	12	8x45°	22.5°
HBA-50	600	560	514	730	12	12x30°	15°
HBA-63	730	690	640	730	12	12x30°	15°
HBA-71	810	770	710	770	12	16x22.5°	11.25°
HBA-80	900	860	800	830	12	16x22.5°	11.25°
HBA-100	1115	1070	1000	1270	15	16x22.5°	11.25°

Characteristic Curves

Q = Airflow in m³/h, m³/s and cfm.

Pe = Static pressure in mmH₂O, Pa and inwg.

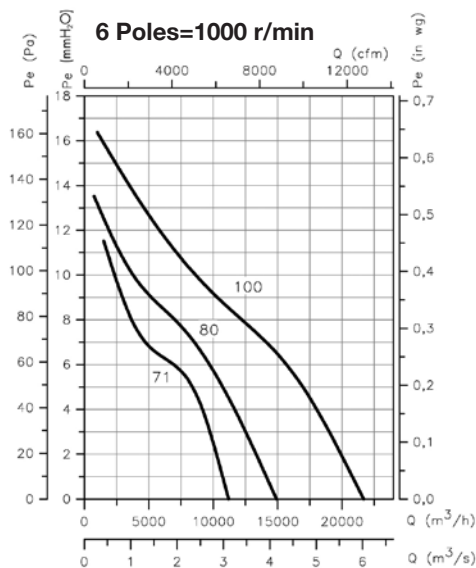
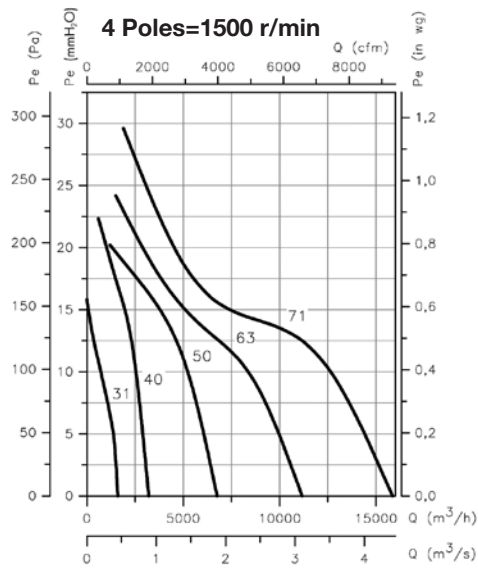
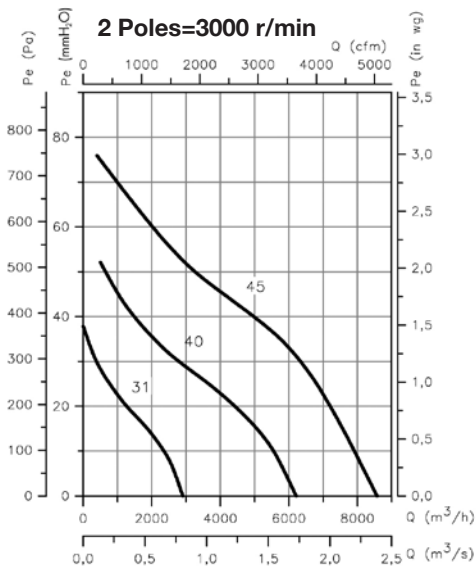

HPX/SEC

Fans designed with the most advanced technology and experience to withstand extreme working conditions in ovens, driers and other applications with temperature and humidity



Fan:

- Thick sheet steel long casing with twist-lock cap.
- Impellers made from cast aluminium
- High-quality bearings with grease for high temperatures
- Bearing support with grease cups
- External grease cups in fan casing
- Airflow direction from motor to impeller

Motor:

- IE2 efficiency motors for capacities equal to or over 0.75kW and below 7.5kW, except single-phase, 2 speed and 8 pole motors.
- IE3 efficiency motors for capacities equal to or over 7.5kW, except single-phase, 2 speed and 8 pole motors
- Class F motors, with ball bearings, IP55 protection
- Single-phase 230V-50Hz and three-phase 230/400V-50Hz (up to 4kW) and 400/690V-50Hz (power over 4kW)
- Fan working temperature: -25°C +150°C

Finish:

- Anticorrosive in heat-resistant paint

On request:

- Airflow direction from impeller to motor
- 100% reversible impellers.
- Special windings for different voltages
- ATEX certification, Category 2 (HPX/ATEX)
- IE2 and IE3 efficiency motors for any power

Order code

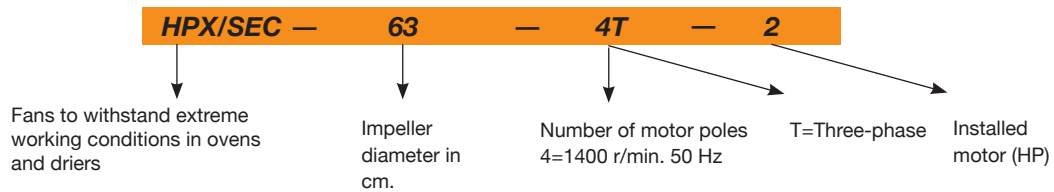

Technical characteristics

Model	Speed (r/min)	Maximum admissible current (A)			Installed capacity (kW)	Maximum airflow (m³/h)	Sound pressure level dB(A)	Approx. weight (Kg)
		230V	400V	690V				
HPX/SEC-63-4T-2	1450	5.96	3.44		1.50	17500	78	68.1
HPX/SEC-71-4T-2	1350	5.96	3.44		1.50	22500	79	84.5
HPX/SEC-71-4T-3	1450	8.36	4.83		2.20	24000	81	91.5
HPX/SEC-80-4T-4	1350	10.96	6.33		3.00	32000	84	107.0
HPX/SEC-80-4T-5.5	1450	14.10	8.12		4.00	40500	84	116.0
HPX/SEC-90-4T-7.5	1400		11.60	6.72	5.50	51000	91	132.5
HPX/SEC-90-4T-10 IE3	1400		14.20	8.20	7.50	54700	92	145.5
HPX/SEC-100-4T-10 IE3	1450		14.20	8.20	7.50	63000	93	148.5
HPX/SEC-100-4T-15 IE3	1450		20.20	11.60	11.00	68000	94	191.5

Acoustic features

The specified values are determined according to free field measurements of pressure and sound levels in dB(A) at an equivalent distance of twice the fan's span plus the impeller's diameter, with a minimum of 1.5 m.

Sound power Lw(A) spectrum in dB(A) via frequency band in Hz.

Model	63	125	250	500	1000	2000	4000	8000	Model	63	125	250	500	1000	2000	4000	8000
HPX/SEC-63-4T-2	62	73	83	89	90	85	74	70	HPX/SEC-90-4T-7.5	69	90	97	102	105	101	94	83
HPX/SEC-71-4T-2	56	76	84	89	91	88	81	70	HPX/SEC-90-4T-10	70	91	98	103	106	102	95	84
HPX/SEC-71-4T-3	65	76	86	92	93	88	77	73	HPX/SEC-100-4T-10	73	93	100	106	108	105	98	87
HPX/SEC-80-4T-4	61	81	89	94	96	93	86	75	HPX/SEC-100-4T-15	74	94	101	107	109	106	99	88
HPX/SEC-80-4T-5.5	68	79	89	95	96	91	80	76									

Dimensions in mm

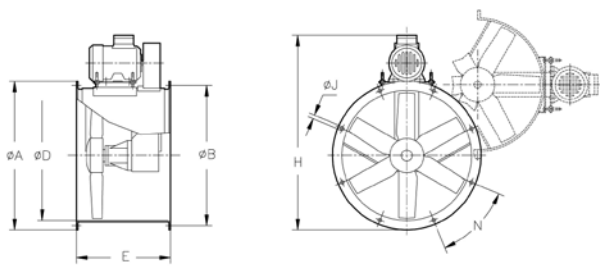

Model	ØA	ØB	ØD	E	H	ØJ	N
HPX/SEC-63-4T-2	730	690	640	500	943	12	12x30°
HPX/SEC-71-4T-2	810	770	710	550	1022	12	16x22°30'
HPX/SEC-71-4T-3	810	770	710	550	1048	12	16x22°30'
HPX/SEC-80-4T-4	900	860	800	600	1164.5	12	16x22°30'
HPX/SEC-80-4T-5.5	900	860	800	600	1185.5	13	16x22°30'
HPX/SEC-90-4T-7.5	1015	970	900	650	1338	15	16x22°30'
HPX/SEC-90-4T-10	1015	970	900	650	1338	15	16x22°30'
HPX/SEC-100-4T-10	1115	1070	1000	750	1453	15	16x22°30'
HPX/SEC-100-4T-15	1115	1070	1000	750	1525	15	16x22°30'

Characteristic Curves

Q = Airflow in m³/h, m³/s and cfm.

Pe = Static pressure in mmH₂O, Pa and inwg.

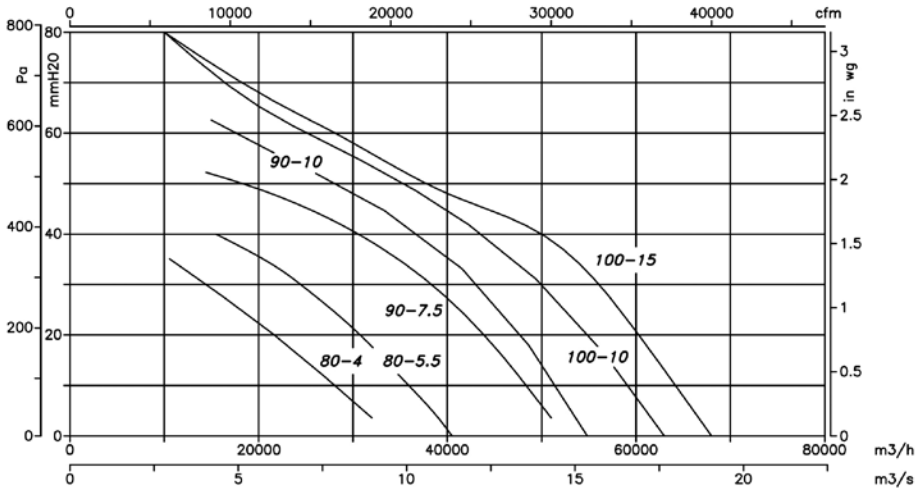
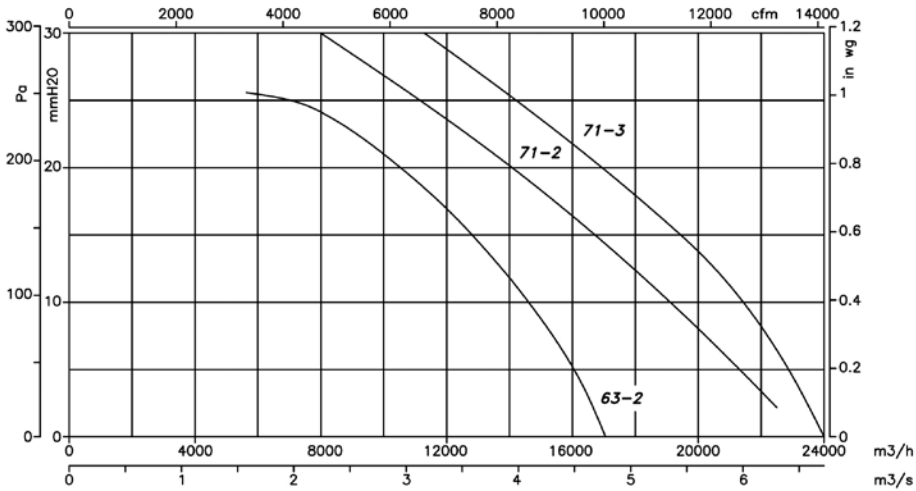

Accessories

See accessories section.

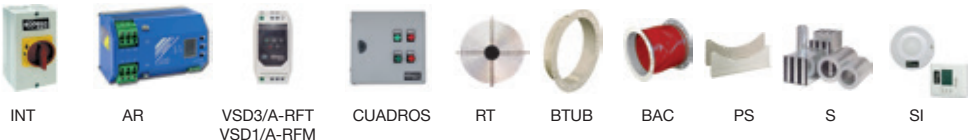

HCH/SEC

65°C
90°C
135°C



Fans designed with the most advanced technology and experience to withstand extreme working conditions in wood and ceramic driers



Fan:

- Sheet steel bracket or stainless steel AISI304 depending on the version
- Impeller made from cast aluminium
- Airflow direction from motor to impeller

Motor version 65°C. 100% RH:

- Class F motors with ball bearings, especially designed for temperature, IP-55 protection
- Motors with forced ventilation
- Three-phase 230/400V50Hz. (up to 4kW) and 400/690V-50Hz. (power over 4kW)
- Fan working temperature: -10°C.+ 65°C. and 100%

Closed motors, without ventilation

- Three-phase 230/400V50Hz. (up to 4kW) and 400/690V-50Hz. (power over 4kW)
- Fan working temperature: -10°C.+ 135°C. and 100% relative humidity

Finish:

- Anticorrosive finish in polyester resin polymerised at 190°C, after degreasing with phosphate-free nanotechnology treatment.
- STAINLESS STEEL version with blast finish

Motor version 90°C. 100% RH:

- Class H motors with ball bearings, especially designed for high temperature, IP-55 protection
- Closed motors, without ventilation
- Three-phase 230/400V50Hz. (up to 3kW) and 400/690V-50Hz. (power over 3kW)
- Fan working temperature: -10°C.+ 90°C. and 100% relative humidity

On request:

- Any HCH Series model may be converted into HCH/SEC
- Airflow direction from impeller to motor
- 100% reversible impellers.
- Special windings for different voltages
- Support ring in AISI-316

Motor version 135°C. 100% RH:

- Class H motors with ball bearings, especially designed for very high temperatures, IP-55 protection
- Cast iron motor support shields
- Axle and screws in STAINLESS STEEL

Order code

HCH/SEC — 63 — 4T — 1.5 — 65° — INOX

Fans designed to withstand extreme working conditions in wood and ceramic driers

Impeller diameter in cm.

Number of motor poles
4=1400 r/min. 50 Hz

T=Three-phase

Installed motor (HP)

Max. working temperature
65°C
90°C
135°C

Made from in stainless version

Technical characteristics

Model	Speed (r/min)	Maximum admissible current (A)		Installed capacity (kW)	Maximum airflow (m³/h)	Sound pressure level dB(A)	Approx. weight (Kg)		
		230V	400V				65°	90°	135°
HCH/SEC-63-4T-1.5	1450	5.2	3	1.1	17000	74	33	39	29
HCH/SEC-63-4T-2	1450	6.41	3.7	1.5	18900	75	36	42	32
HCH/SEC-63-4T-3	1450	8.49	4.9	2.2	22100	76	44	50	36
HCH/SEC-63-4T-4	1450	11.78	6.8	3	25400	77	46	52	39
HCH/SEC-71-4T-1.5	1450	5.2	3	1.1	19750	78	37	45	32
HCH/SEC-71-4T-2	1450	6.41	3.7	1.5	21100	79	40	47	35
HCH/SEC-71-4T-3	1450	8.49	4.9	2.2	23950	81	49	56	40
HCH/SEC-71-4T-4	1450	11.78	6.8	3	29400	82	51	58	43
HCH/SEC-80-4T-3	1450	8.49	4.9	2.2	28000	82	60	73	50
HCH/SEC-80-4T-4	1450	11.78	6.8	3	32700	83	62	75	53
HCH/SEC-80-4T-5.5	1450	15.24	8.8	4	37200	84	67	80	56

Acoustic features

The specified values are determined according to free field measurements of pressure and sound levels in dB(A) at an equivalent distance of twice the fan's span plus the impeller's diameter, with a minimum of 1.5 m.

Sound power Lw(A) spectrum in dB(A) via frequency band in Hz.

Model	63	125	250	500	1000	2000	4000	8000	Model	63	125	250	500	1000	2000	4000	8000
HCH/SEC-63-4T-1.5	51	71	79	84	86	83	76	65	HCH/SEC-71-4T-3	58	78	86	91	93	90	83	72
HCH/SEC-63-4T-2	52	72	80	85	87	84	77	66	HCH/SEC-71-4T-4	59	79	87	92	94	91	84	73
HCH/SEC-63-4T-3	53	73	81	86	88	85	78	67	HCH/SEC-80-4T-3	59	79	87	92	94	91	84	73
HCH/SEC-63-4T-4	54	74	82	87	89	86	79	68	HCH/SEC-80-4T-4	60	80	88	93	95	92	85	74
HCH/SEC-71-4T-1.5	55	75	83	88	90	87	80	69	HCH/SEC-80-4T-5.5	61	81	89	94	96	93	86	75
HCH/SEC-71-4T-2	56	76	84	89	91	88	81	70									

Dimensions in mm

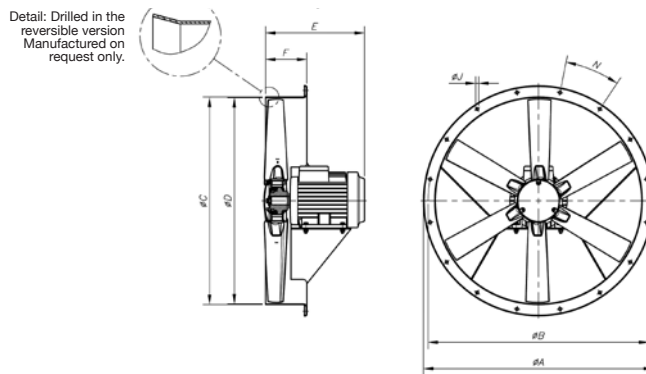

Model	ØA	ØB	ØC	ØD	E					F	ØJ	N
					1.5	2	3	4	5.5			
HCH/SEC-63-4-65°	730	690	645	640	325	355	405	405	-	150	12	12 X 30°
HCH/SEC-63-4-90°	730	690	645	640	305	330	360	360	-	150	12	12 X 30°
HCH/SEC-63-4-135°	730	690	645	640	343	343	370	370	-	150	12	12 X 30°
HCH/SEC-71-4-65°	810	770	715	710	330	350	415	415	-	150	12	16 X 22°30'
HCH/SEC-71-4-90°	810	770	715	710	302	322	367	367	-	150	12	16 X 22°30'
HCH/SEC-71-4-135°	810	770	715	710	358	358	370	370	-	150	12	16 X 22°30'
HCH/SEC-80-4-65°	900	860	805	800	-	-	425	425	445	180	12	16 X 22°30'
HCH/SEC-80-4-90°	900	860	805	800	-	-	375	375	390	180	12	16 X 22°30'
HCH/SEC-80-4-135°	900	860	805	800	-	-	390	390	390	180	12	16 X 22°30'

Characteristic Curves

See HCH series characteristic curves

Accessories

See accessories section.



VAM VAC

VAM: Axial fans with galvanised frame and IP65 motor
VAC: Axial fans for ducts with IP65 motor

Wall-mounted axial fans specially designed for use in farms and corrosive environments.

Fan:

- Airflow direction from motor to impeller
- Impeller in polyamide 6 reinforced with fibre glass
- VAM: Support frame in hot galvanised sheet steel
- VAM: Protection guard to prevent contacts according to standard UNE-EN ISO 12499:2010
- VAC: Hot-rolled galvanised steel construction



VAM

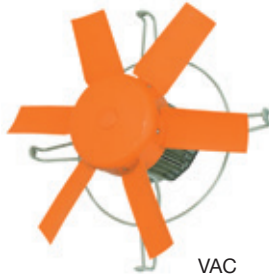

VAC

Motor:

- Class F motors with built-in thermal protector, ball bearings and IP65 protection
- Single-phase 220-240V.-50Hz. and three-phase 220-240/380-415V.-50Hz.
- Fan working temperature: -25°C+ 60°C, 4-6 pole motors

Finish:

- Hot galvanised anticorrosive

Order code



VAM: Galvanised axial fans
 VAC: Axial fans for ducts

Impeller diameter in cm.

Number of motor poles
 2=2900 r/min. 50 Hz
 4=1400 r/min. 50 Hz
 6=750 r/min. 50 Hz

M=Single-phase
 T=Three-phase

Technical characteristics

Model	Speed (r/min)	Current at free airflow (A)		Installed free airflow (W)	Maximum airflow (m³/h)	Sound pressure level dB(A)	Approx. weight (Kg)		
		220V- 240V	380V-415V				VAM	VAC	
VAM-35 T4	VAC-35 T4	1340	0.74	0.43	155	3500	58	7.1	4.2
VAM-35 M4	VAC-35 M4	1340	0.98		160	3500	58	7.1	4.2
VAM-40 T4	VAC-40 T4	1450	2.10	1.20	185	4000	60	10.6	8.5
VAM-40 M4	VAC-40 M4	1420	1.55		260	4000	60	10.6	8.5
VAM-45 T4	VAC-45 T4	1440	2.10	1.20	300	5810	64	11	9
VAM-45 M4	VAC-45 M4	1360	1.85		315	5810	64	11	9
VAM-50 T4	VAC-50 T4	1400	2.15	1.25	390	7300	69	13	11
VAM-50 M4	VAC-50 M4	1370	2.30		430	7300	69	13	11
VAM-56 T6	VAC-56 T6	915	1.73	1.00	325	8250	62	17	15
VAM-56 M6	VAC-56 M6	915	2.12		450	8250	62	17	15
VAM-63 T6	VAC-63 T6	905	2.06	1.19	405	12050	65	20	18
VAM-63 M6	VAC-63 M6	905	2.70		540	12050	65	20	18



Erp. BEP (best efficiency point) characteristics

MC	Measurement category	ηe[%]	Efficiency
EC	Efficiency category	N	Degree of efficiency
S	Static	[kW]	Electrical power
T	Total	[m³/h]	Airflow
VSD	Variable-speed drive	[mmH₂O]	Static or total pressure (According to EC)
SR	Specific relationship	[RPM]	Speed

Model	MC	EC	VSD	SR	ηe [%]	N	[kW]	[m3/h]	[mmH₂O]	[RPM]
35 T4	A	S	NO	1.00	28.3%	39.9	0.145	2167	6.95	1418
35 M4	A	S	NO	1.00	26.1%	37.4	0.158	2191	6.89	1430
40 T4	A	S	NO	1.00	26.3%	37.5	0.172	2248	7.41	1476
45 T4	A	S	NO	1.00	33.0%	42.7	0.292	3719	9.53	1467
45 M4	A	S	NO	1.00	30.9%	40.4	0.314	3805	9.36	1439
50 T4	A	S	NO	1.00	32.9%	41.8	0.387	4894	9.54	1446
50 M4	A	S	NO	1.00	29.0%	37.6	0.438	4853	9.61	1434
56 T6	A	S	NO	1.00	27.7%	37.5	0.283	4469	6.46	964
63 T6	C	S	NO	1.00	28.5%	37.6	0.373	6577	5.95	957

Dimensions in mm

VAM

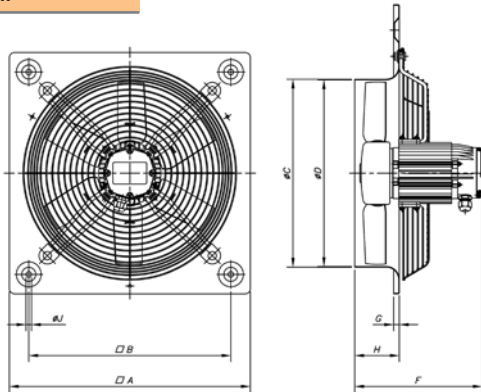

Model	∇A	∇B	∅C	∅D	F		G	H	∅J
					Single-phase	Three-phase			
VAM-35	465	390	363	360	209	209	11	86	10.5
VAM-40	532	452	413	410	235	210	11	105	10.5
VAM-45	596	504	463	460	235	210	11	105	10.5
VAM-50	665	562	517	514	255	215	11	115	10.5
VAM-56	710	630	563	560	261	241	11	115	10.5
VAM-63	800	710	638	635	261	251	11	140	10.5

VAC

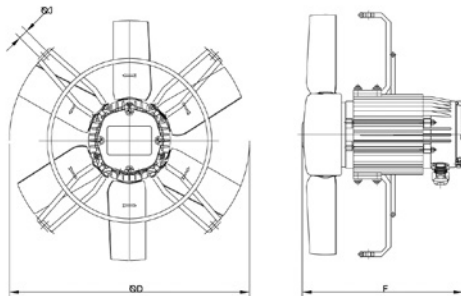

Model	∅D	F		∅J
		Single-phase	Three-phase	
VAC-35	360	203	203	M8
VAC-40	410	231	206	M8
VAC-45	460	231	206	M8
VAC-50	520	251	211	M8
VAC-56	580	251	231	M8
VAC-63	650	251	421	M8

Characteristic Curves

Q = Airflow in m³/h, m³/s and cfm.

Pe = Static pressure in mmH₂O, Pa and inwg.

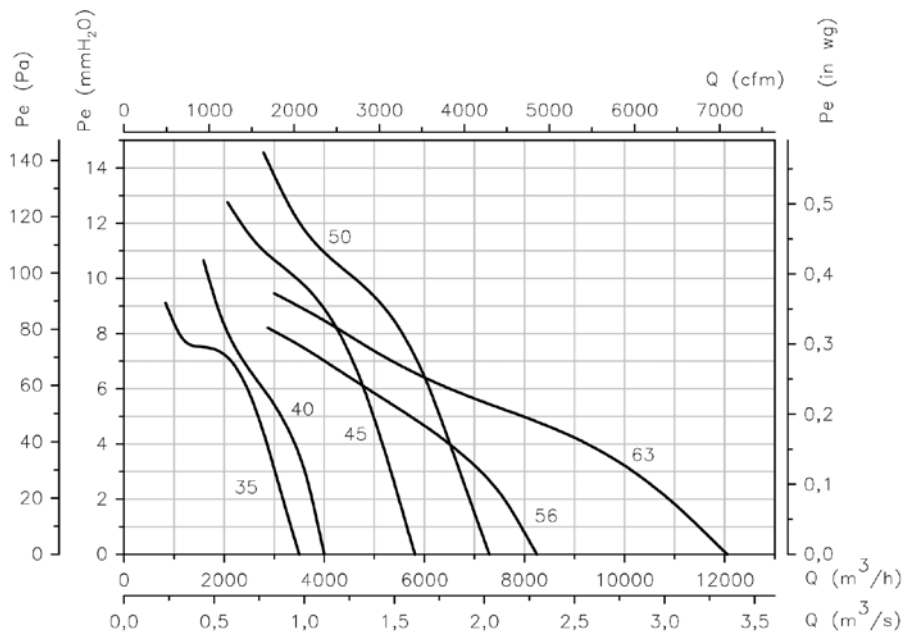

Accessories

See accessories section.

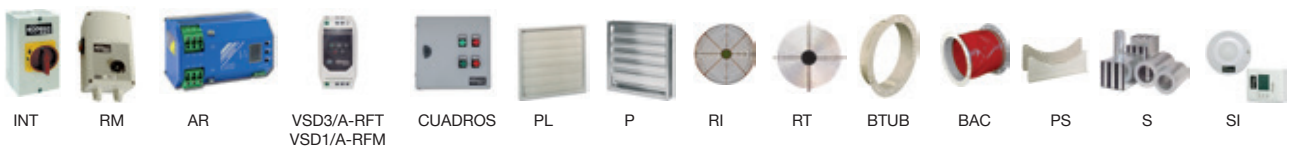



HGI



Large-diameter axial fan for farms

Wall-mounted axial fans designed for large, low-speed airflows with automatic louvre opening system.

Fan:

- Sheet steel base plate.
- Galvanised steel structure
- Galvanised sheet steel impeller
- Protection guard to prevent contacts according to standard UNE-EN ISO 12499:2010
- Designed especially for use in farms and hothouses
- Airflow direction from motor to impeller

Motor:

- IE2 efficiency motors for capacities equal to or over 0.75kW and below 7.5kW, except single-phase, 2 speed and 8 pole motors.
- Class F motors, with ball bearings, IP55 protection
- Three-phase 230/400V.-50Hz
- Fan working temperature: -25°C + 50°C

Finish:

- Anticorrosive galvanized sheet steel

On request:

- Without shutter and with a protective grille on the impulsion side
- Special windings for different voltages

Order code

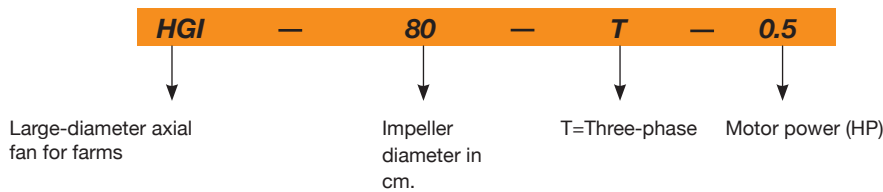

Technical characteristics

Model	Speed (r/min)	Maximum admissible current (A)		Installed capacity (kW)	Maximum airflow (m³/h)	Sound pressure level dB(A)	Approx. weight (Kg)
		230V	400V				
HGI-80-T-0.5	570	1.70	1.00	0.37	16000	63	48
HGI-80-T-0.75	630	2.40	1.40	0.55	18000	65	49
HGI-100-T-0.5	398	2.10	1.20	0.37	25000	62	63
HGI-100-T-0.75	472	2.80	1.60	0.55	29000	65	64
HGI-100-T-1	503	3.50	2.00	0.75	32000	66	66
HGI-125-T-1	437	3.50	2.00	0.75	38000	69	87
HGI-125-T-1.5	485	4.80	2.80	1.10	43000	72	90

Acoustic features

The specified values are determined according to free field measurements of pressure and sound levels in dB(A) at an equivalent distance of twice the fan's span plus the impeller's diameter, with a minimum of 1.5 m.

Sound power Lw(A) spectrum in dB(A) via frequency band in Hz.

Model	63	125	250	500	1000	2000	4000	8000	Model	63	125	250	500	1000	2000	4000	8000
HGI-80-T-0.5	57	64	72	74	72	69	66	58	HGI-100-T-1	61	69	77	79	77	74	70	63
HGI-80-T-0.75	59	66	74	76	74	71	68	60	HGI-125-T-1	64	72	80	82	80	77	73	66
HGI-100-T-0.5	57	65	73	75	73	70	66	59	HGI-125-T-1.5	67	75	83	85	83	80	76	69
HGI-100-T-0.75	60	68	76	78	76	73	69	62									

Characteristic Curves

Q = Airflow in m³/h, m³/s and cfm. Pe = Static pressure in mmH₂O, Pa and inwg.

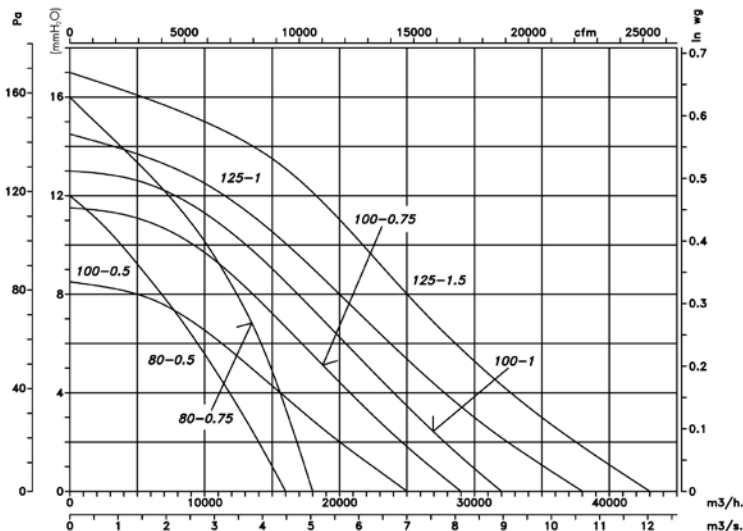

Dimensions in mm

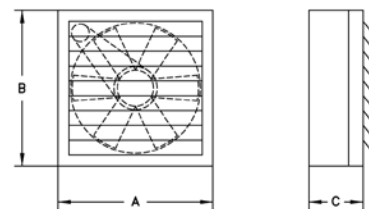

Model	A	B	C
HGI-80	925	925	427
HGI-100	1125	1125	447
HGI-125	1375	1375	480

Accessories

See accessories section.



KIT SOBREPRESIÓN

The system of pressurising staircases, escape routes or confined areas makes it possible to control the airflow automatically and to maintain a differential pressure of 50 Pa in a single stage, according to standard UNE EN 12101-6-2006.

STAIRWELL OVERPRESSURE KIT
Three-phase equipment



STAIRWELL OVERPRESSURE KIT

- Stairwell overpressure kit made up of control panel (BOXPRES KIT) and outlet units (CJHCH or CJBD), for the pressurisation of the stairwells and escape routes. Also available for single-phase equipment's NEOLINEO and CJBC.

OVERPRESSURE KIT WITH RESERVE FAN

- Overpressure kit with reserve fan, made up of control panel (BOXPRES KIT II), which incorporates a system of automatic switching to keep the overpressure in the case of a stop by the main fan and TWIN or CJHCH/DUPLEX air outlet units with reserve fan.

STAIRWELL OVERPRESSURE KIT
For single-phase equipment



BOXPRES



- Easy to install
- Compact and self-sufficient solution
- Preventive maintenance
- Easy starting
- Safe and functional installation



- The proper operation of the pressurisation systems depends not only on correct design but also on the proper regulation carried out by the system with the result that it is of vital importance to have calibrated and highly-precise regulation elements which make it possible to have the two situations in the case of fire, in a rapid and stable manner.
- The BOXPRES control panel, apart from satisfying the most demanding requirements, simplifies the work of the installer to the greatest possible extent.

Includes:

- Frequency inverter programmed to 50 Pa
- Differential pressure probe
- Magneto thermal
- Line LED and fault
- Check button

BOXPRES is a piece of equipment with all its interconnections made and tested

- Ready to work and carry out its duties on the pressure control of the installation.
- Possibility of checking the installation so as to prevent faults
- Only the power cable, the impulsion fan and the fire signal should be connected.

The panels for single-phase equipment include:

- Voltage regulator programmed to 50 Pa
- Differential pressure probe external to the equipment.

OVERPRESSURE KIT
WITH RESERVE FAN



Order code

KIT SOBREPRESIÓN — 7.100

Kit sobrepresión: Overpressure set for staircases
Kit sobrepresión II: Overpressure set with reserve fan

Maximum airflow

Technical characteristics

Model	Power supply	Output	Outlet unit	Airflow (m³/h)	Irradiated sound level* dB(A)
KIT SOBREPRESION-1060-LED	230 Vac II	230 Vac II	NEOLINEO-200	1060	38
KIT SOBREPRESION-2300-LED	230 Vac II	230 Vac II	NEOLINEO-315	2300	47
KIT SOBREPRESION-2880-LED	230 Vac II	230 Vac II	CJBC-2828-6M 1/3	2880	61
KIT SOBREPRESION-7100-LED	230 Vac II	230 Vac III	CJHCH-45-4T-0.5	7100	55
KIT SOBREPRESION-7800-LED	230 Vac II	230 Vac III	CJBD-3333-6T-1.5	7800	55
KIT SOBREPRESION-12900-LED	230 Vac II	230 Vac III	CJHCH-56-4T-1	12900	60
KIT SOBREPRESION-17000-LED	230 Vac II	230 Vac III	CJHCH-63-4T-1.5	17000	61
KIT SOBREPRESION-7100-BOX	400 Vac III	400 Vac III	CJHCH-45-4T-0.5	7100	55
KIT SOBREPRESION-7800-BOX	400 Vac III	400 Vac III	CJBD-3333-6T-1.5	7800	55
KIT SOBREPRESION-12900-BOX	400 Vac III	400 Vac III	CJHCH-56-4T-1	12900	60
KIT SOBREPRESION-17000-BOX	400 Vac III	400 Vac III	CJHCH-63-4T-1.5	17000	61
KIT SOBREPRESION II-6240-BOX	400 Vac III	400 Vac III	TWIN-12/12-6T-1,5	6240	55
KIT SOBREPRESION II-9520-BOX	400 Vac III	400 Vac III	TWIN-15/15-6T-3	9520	54
KIT SOBREPRESION II-12900-BOX	400 Vac III	400 Vac III	CJHCH/DUPLEX-56-4T-1-H	12900	60
KIT SOBREPRESION II-17000-BOX	400 Vac III	400 Vac III	CJHCH/DUPLEX-63-4T-1.5-H	17000	61
SI-PRESIÓN TPDA					
SI-PRESSURE TPDA w/DISPLAY					
BOXPRES KIT-3A 230Vac	230 Vac II	230 Vac II			
BOXPRES KIT-10A 230Vac	230 Vac II	230 Vac II			
BOXPRES KIT-0,75kW 230Vac	230 Vac II	230 Vac III			
BOXPRES KIT-1,5kW 230Vac	230 Vac II	230 Vac III			
BOXPRES KIT-0,75kW 400Vac	400 Vac III	400 Vac III			
BOXPRES KIT-1,5kW 400Vac	400 Vac III	400 Vac III			
BOXPRES KIT-2,2kW 400Vac	400 Vac III	400 Vac III			
BOXPRES KIT II - 1,5kW 400Vac	400 Vac III	400 Vac III			
BOXPRES KIT II - 2,2kW 400Vac	400 Vac III	400 Vac III			

Dimensions in mm

CJHCH

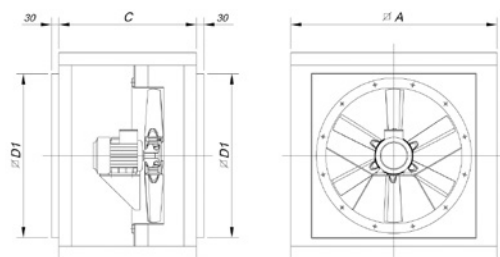

Model	ØA	C	ØD1
CJHCH-40/45/50	700	550	565
CJHCH-56/63	825	550	690

CJBD

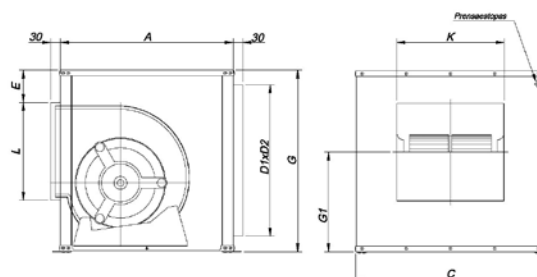

Model	Equiv. inches	A	B	C	E	D1xD2	G1	L	K
CJBD-3333	12/12	650	650	700	92	556X606	379	358	400

Dimensions in mm

TWIN

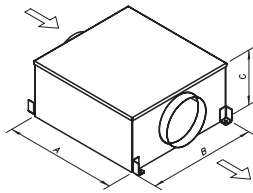

Model	A	B	C
TWIN-12/12	1103	1139	610
TWIN15/15	1279	1639	698

CJHCH/DUPLEX

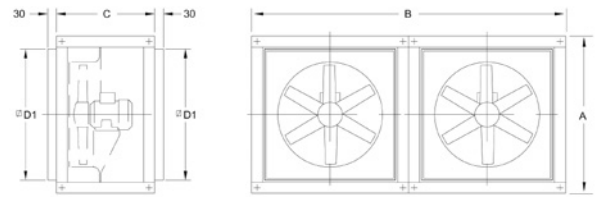

Model	∅A	B	C	∅D1
CJHCH/DUPLEX-56/63	825	1650	550	690

NEOLINEO

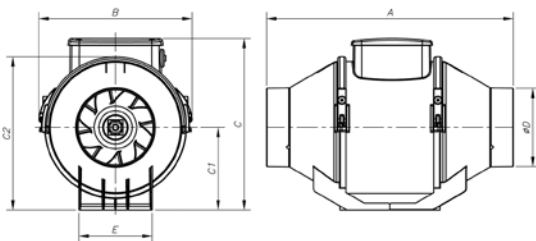

Model	A	B	C	C1	C2	∅D	E
NEOLINEO-200	300	234.5	260.5	125.5	235	196	140
NEOLINEO-315	448	361.5	392.5	188.5	359	312	220.5

CJBC

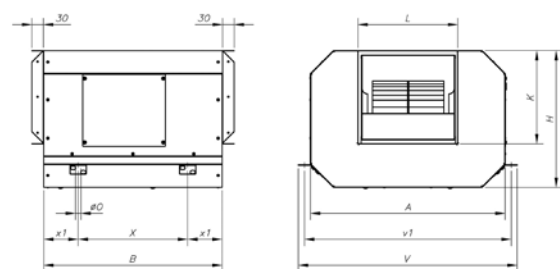

Model	A	B	H	K	L	∅O	V	v1	X	x1
CJBC-2828-6M-1/3	696	645	460	290	320	15	755	725	445	100

BOXPRESS KIT SOBREPRESIÓN

Technical characteristics and measurements

Model	Power (kW)	Power supply (V/Hz)	Output (V/Hz)	Output current (A)	Size	Measurements
						(L x W x D)
BOXPRES KIT-3A 230Vac	-	230 Vac II	230 Vac II	3	-	255 x 170 x 140 mm
BOXPRES KIT-10A 230Vac	-	230 Vac II	230 Vac II	10	-	255 x 170 x 140 mm
BOXPRES KIT-0,75kW 230Vac	0.75	230 V II / 50Hz	230 V III / 50Hz	4.3	1	270 x 270 x 170 mm
BOXPRES KIT-1,5kW 230Vac	1.5	230 V II / 50Hz	230 V III / 50Hz	7	1	270 x 270 x 170 mm
BOXPRES KIT-0,75kW 400Vac	0.75	400 V III / 50Hz	400 V III / 50Hz	2.2	1	270 x 270 x 170 mm
BOXPRES KIT-1,5kW 400Vac	1.5	400 V III / 50Hz	400 V III / 50Hz	4.1	1	270 x 270 x 170 mm
BOXPRES KIT-2,2kW 400Vac	2.2	400 V III / 50Hz	400 V III / 50Hz	5.8	2	360 x 360 x 205 mm

Stuffing-box for cable input to equipment

BOXPRES KIT-3A / KIT-10A

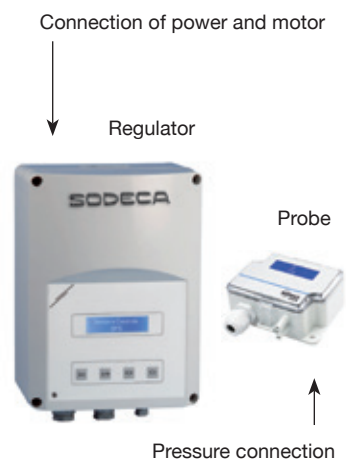

BOXPRES KIT sizes 1 and 2

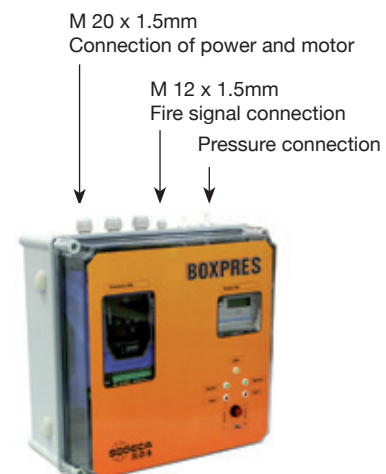

BOXPRES KIT SOBREPRESIÓN II

For equipment with reserve fan.

Technical characteristics and measurements

Model	Power (kW)	Power supply (V/Hz)	Output (V/Hz)	Output current (A)	Size	Measurements (L x W x D)
BOXPRES KIT II - 1,5KW 400Vac	1.5	400 V III / 50Hz	400 V III / 50Hz	4.1	1	270 x 270 x 170 mm
BOXPRES KIT II - 2,2KW 400Vac	2.2	400 V III / 50Hz	400 V III / 50Hz	5.4	2	360 x 360 x 205 mm

* Both motors never operate simultaneously

Stuffing-box for cable input to equipment

BOXPRES KIT sizes 1 and 2

M 20 x 1.5mm
Connection of power and motor

M 12 x 1.5mm
Fire signal connection

Pressure connection



Example of use

Overpressure smoke control method; this system consists of pressurization by means of injecting air into spaces which are used as escape routes for people in case of fire, such as stair wells, passageways, corridors, elevators, etc. Above all in densely occupied tall buildings. This method is based on smoke control by means of the speed of air and the artificial barrier which is created by excess air pressure over smoke, so that it cannot enter escape routes.



HTMH

Multifunctional roof fans for large flows

Multifunctional roof fans, highly robust construction, for large flows

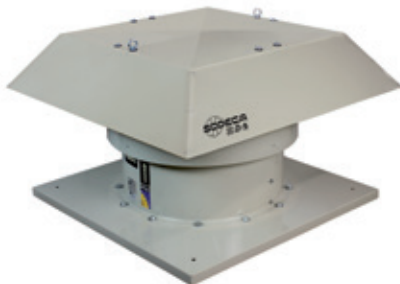

Fan:

- Painted galvanised sheet steel base plate
- Adjustable cast aluminium impellers.
- Protection guard to prevent contacts according to standard UNE-EN ISO 12499:2010
- Painted galvanised sheet steel hood with natural air outlet.

Motor:

- IE2 efficiency motors for capacities equal to or over 0.75kW and below 7.5kW, except single-phase, 2 speed and 8 pole motors.
- IE3 efficiency motors for capacities equal to or over 7.5kW, except single-phase, 2 speed and 8 pole motors
- Class F motors with ball bearings, IP55 protection, one- or two-speed depending on the model
- Single-phase 230V-50Hz and three-phase 230/400V-50Hz (up to 4 kW) and 400/690V-50Hz (power over 4 kW)
- Fan working temperature: -25°C + 50°C

Finish:

- Anticorrosive finish in polyester resin polymerised at 190°C, after degreasing with phosphate-free nanotechnology treatment.
- Finish surface quality C4H

On request:

- ATEX and two-speed motors
- Made entirely from stainless steel.
- Hot-rolled galvanised steel construction
- Marine motors for naval applications with certification for essential service by various classifying societies (BV, DNV, LR)
- CE, NEMA, UL, CSA motors
- Finish surface quality C5M
- IE2 and IE3 efficiency motors for any power

Order code

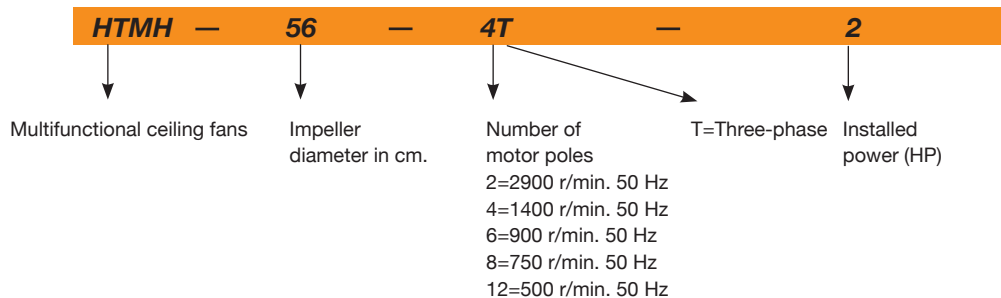

Technical characteristics

Model	Speed (r/min)	Maximum admissible current (A)			Installed capacity (kW)	Maximum airflow (m³/h)	Sound pressure (1) level dB(A)		Approx. weight (Kg)
		230V	400V	690V			Inlet	Outlet	
HTMH-56-4T-1	1410	2.83	1.63		0.75	10545	62	59	67
HTMH-56-4T-1.5	1400	4.03	2.32		1.10	11400	63	60	69
HTMH-56-4/8T-1.5	1440 / 710		2.90 / 1.30		1.10 / 0.25	11400 / 5700	63 / 48	60 / 45	67
HTMH-56-6T-0.75	910	2.59	1.49		0.55	8170	51	49	67
HTMH-63-4T-1.5	1400	4.03	2.32		1.10	13870	65	62	81
HTMH-63-4/8T-1.5	1440 / 710		2.90 / 1.30		1.10 / 0.25	13870 / 6935	65 / 50	62 / 47	79
HTMH-63-4T-2	1440	5.67	3.26		1.50	15485	66	63	87
HTMH-63-4/8T-2	1420 / 700		3.50 / 1.50		1.50 / 0.37	15485 / 7742	66 / 51	63 / 48	80
HTMH-63-4T-3	1435	8.07	4.64		2.20	17955	67	64	96
HTMH-63-4/8T-3	1430 / 710		4.90 / 1.70		2.20 / 0.45	17955 / 8977	67 / 52	64 / 49	86
HTMH-63-6T-0.75	910	2.59	1.49		0.55	10260	56	54	79
HTMH-63-6T-1	925	3.39	1.95		0.75	11305	57	55	84
HTMH-71-4T-2	1440	5.67	3.26		1.50	16150	69	66	93
HTMH-71-4/8T-2	1420 / 700		3.50 / 1.50		1.50 / 0.37	16150 / 8075	69 / 54	66 / 51	86
HTMH-71-4T-3	1435	8.07	4.64		2.20	18430	71	68	101
HTMH-71-4/8T-3	1430 / 710		4.90 / 1.70		2.20 / 0.45	18430 / 9215	71 / 56	68 / 53	91
HTMH-71-4T-4	1420	10.70	6.17		3.00	22610	72	69	104

Technical characteristics

Model	Speed (r/min)	Maximum admissible current (A)			Installed capacity (kW)	Maximum airflow (m³/h)	Sound pressure (1) level dB(A)		Approx. weight (Kg)
		230V	400V	690V			Inlet	Outlet	
HTMH-71-4/8T-4	1430 / 710		6.50 / 2.30		3.00 / 0.60	22610 / 11305	72 / 57	69 / 54	98
HTMH-71-6T-1	925	3.39	1.95		0.75	13205	58	56	90
HTMH-71-6T-1.5	925	4.83	2.78		1.10	16245	59	57	94
HTMH-80-4T-4	1420	10.70	6.17		3.00	27600	73	70	127
HTMH-80-4/8T-4	1430 / 710		6.50 / 2.30		3.00 / 0.60	27600 / 13800	73 / 58	70 / 55	121
HTMH-80-4T-5.5	1440	14.10	8.12		4.00	30176	74	71	136
HTMH-80-4/8T-5.5	1430 / 710		8.20 / 2.90		4.00 / 0.80	30176 / 15088	74 / 59	71 / 56	125
HTMH-80-6T-1.5	925	4.83	2.78		1.10	19412	62	60	117
HTMH-80-6T-2	940	6.45	3.71		1.50	22172	63	61	122
HTMH-80-6T-3	955	10.30	5.94		2.20	24932	64	62	132
HTMH-80-8T-1	705	4.68	2.70		0.75	16376	61	60	117
HTMH-90-4T-5.5	1440	14.10	8.12		4.00	35052	79	76	158
HTMH-90-4/8T-5.5	1430 / 710		8.20 / 2.90		4.00 / 0.80	35052 / 17526	79 / 64	76 / 61	147
HTMH-90-4T-7.5	1460		10.50	6.09	5.50	38456	81	78	176
HTMH-90-4/8T-7.5	1450 / 720		11.80 / 3.80		5.50 / 1.10	38456 / 19228	81 / 66	78 / 63	166
HTMH-90-4T-10 IE3	1465		13.90	8.06	7.50	41308	82	79	194
HTMH-90-4/8T-9	1460 / 725		15.30 / 5.40		7.50 / 1.50	41308 / 20654	82 / 67	79 / 64	175
HTMH-90-6T-3	955	10.30	5.94		2.20	29256	68	66	154
HTMH-90-6/12T-3	940 / 470		5.60 / 2.20		2.20 / 0.37	29256 / 14628	68 / 53	66 / 51	148
HTMH-90-6T-4	960	12.70	7.30		3.00	32016	69	67	177
HTMH-90-6/12T-4	960 / 480		9.00 / 3.50		3.00 / 0.55	32016 / 16008	69 / 54	67 / 52	166
HTMH-90-8T-1	705	4.68	2.70		0.75	17020	61	60	139
HTMH-90-8T-2	705	7.10	4.10		1.50	19596	63	62	150
HTMH-100-4T-7.5	1460		10.50	6.09	5.50	40756	84	81	200
HTMH-100-4/8T-7.5	1450 / 720		11.80 / 3.80		5.50 / 1.10	40756 / 20378	84 / 69	81 / 66	190
HTMH-100-4T-10 IE3	1465		13.90	8.06	7.50	47564	85	82	218
HTMH-100-4/8T-9	1460 / 725		15.30 / 5.40		7.50 / 1.50	44528 / 22264	84 / 69	81 / 66	199
HTMH-100-4T-15 IE3	1470		20.90	12.10	11.00	51336	86	83	253
HTMH-100-4/8T-14	1470 / 725		23.20 / 8.70		11.00 / 2.80	48300 / 24150	85 / 70	82 / 67	230
HTMH-100-6T-3	955	10.30	5.94		2.20	32476	74	72	178
HTMH-100-6/12T-3	940 / 470		5.60 / 2.20		2.20 / 0.37	32476 / 16238	74 / 59	72 / 57	172
HTMH-100-6T-4	960	12.70	7.30		3.00	35420	75	73	201
HTMH-100-6/12T-4	960 / 480		9.00 / 3.50		3.00 / 0.55	35420 / 17710	75 / 60	73 / 58	190
HTMH-100-6T-5.5	960	16.50	9.46		4.00	40020	76	74	208
HTMH-100-6/12T-5.5	970 / 480		11.00 / 4.00		4.00 / 0.65	40020 / 20010	76 / 61	74 / 59	200
HTMH-100-8T-3	705	9.53	5.50		2.20	26404	69	68	186
HTMH-100-8T-4	705	12.82	7.40		3.00	28704	70	69	193
HTMH-125-4T/3-10 IE3	1465		13.90	8.06	7.50	55250	75	72	337
HTMH-125-4T/3-15 IE3	1470		21.40	12.40	11.00	72150	76	73	382
HTMH-125-4T/3-20 IE3	1465		28.70	16.60	15.00	83120	78	75	377
HTMH-125-4T/6-15 IE3	1470		21.40	12.40	11.00	66800	76	73	398
HTMH-125-4T/6-20 IE3	1465		28.70	16.60	15.00	72900	76	73	393
HTMH-125-4T/9-20 IE3	1465		28.70	16.60	15.00	76310	75	72	408
HTMH-125-6T/6-5.5	960	16.50	9.46		4.00	47760	63	61	343
HTMH-125-6T/6-7.5	960		12.80	7.42	5.50	55600	63	61	347
HTMH-125-6T/6-10 IE3	970		14.80	8.58	7.50	66170	65	63	369
HTMH-125-6T/6-15 IE3	970		22.00	12.80	11.00	76380	67	65	399
HTMH-125-6T/9-7.5	960		12.80	7.42	5.50	50000	64	62	362
HTMH-125-6T/9-10 IE3	970		14.80	8.58	7.50	59340	64	62	384
HTMH-125-6T/9-15 IE3	970		22.00	12.80	11.00	71890	67	65	414
HTMH-125-6T/9-20 IE3	975		28.00	16.20	15.00	83660	70	68	467
HTMH-125-8T/6-4	705	12.82	7.40		3.00	47510	56	55	328
HTMH-125-8T/6-5.5	710	16.11	9.30		4.00	52770	58	57	345
HTMH-125-8T/6-7.5	710		12.00	7.20	5.50	60410	60	59	361
HTMH-125-8T/6-10	725		16.00	9.50	7.50	66030	61	60	389
HTMH-125-8T/9-5.5	710	16.11	9.30		4.00	51330	58	57	360
HTMH-125-8T/9-7.5	710		12.00	7.20	5.50	54480	61	60	376
HTMH-125-8T/9-10	725		16.00	9.50	7.50	65660	63	62	404
HTMH-125-8T/9-15	720		24.00	13.80	11.00	73870	64	63	426

(1) The sound level values are measurements of pressure in dB(A) at a distance of 6 m and free field

Acoustic features

Sound power Lw(A) spectrum in dB(A) via frequency band in Hz.

Values taken at inlet with maximum airflow.

Model	63	125	250	500	1000	2000	4000	8000
56-4-1	46	67	74	79	82	78	71	60
56-4-1.5	47	68	75	80	83	79	72	61
56-6-0.75	35	56	63	68	71	67	60	49
56-8-1.5	32	53	60	65	68	64	57	46
63-4-1.5	49	70	77	82	85	81	74	63
63-4-2	50	71	78	83	86	82	75	64
63-4-3	51	72	79	84	87	83	76	65
63-6-0.75	40	61	68	73	76	72	65	54
63-6-1	41	62	69	74	77	73	66	55
63-8-1.5	34	55	62	67	70	66	59	48
63-8-2	35	56	63	68	71	67	60	49
63-8-3	36	57	64	69	72	68	61	50
71-4-2	53	74	81	86	89	85	78	67
71-4-3	55	76	83	88	91	87	80	69
71-4-4	56	77	84	89	92	88	81	70
71-6-1	42	63	70	75	78	74	67	56
71-6-1.5	43	64	71	76	79	75	68	57
71-8-2	38	59	66	71	74	70	63	52
71-8-3	40	61	68	73	76	72	65	54
71-8-4	41	62	69	74	77	73	66	55
80-4-4	57	78	85	90	93	89	82	71
80-4-5.5	58	79	86	91	94	90	83	72
80-6-1.5	46	67	74	79	82	78	71	60
80-6-2	47	68	75	80	83	79	72	61
80-6-3	48	69	76	81	84	80	73	62
80-8-1	45	66	73	78	81	77	70	59
80-8-4	42	63	70	75	78	74	67	56
80-8-5.5	43	64	71	76	79	75	68	57
90-4-5.5	63	84	91	96	99	95	88	77
90-4-7.5	65	86	93	98	101	97	90	79
90-4-9	66	87	94	99	102	98	91	80
90-4-10	66	87	94	99	102	98	91	80
90-6-3	52	73	80	85	88	84	77	66
90-6-4	53	74	81	86	89	85	78	67
90-8-1	45	66	73	78	81	77	70	59
90-8-2	47	68	75	80	83	79	72	61
90-8-5.5	48	69	76	81	84	80	73	62
90-8-7.5	50	71	78	83	86	82	75	64
90-8-9	51	72	79	84	87	83	76	65
90-12-3	37	58	65	70	73	69	62	51
90-12-4	38	59	66	71	74	70	63	52
100-4-7.5	68	89	96	101	104	100	93	82
100-4-9	68	89	96	101	104	100	93	82
100-4-10	69	90	97	102	105	101	94	83
100-4-14	69	90	97	102	105	101	94	83
100-4-15	70	91	98	103	106	102	95	84
100-6-3	58	79	86	91	94	90	83	72
100-6-4	59	80	87	92	95	91	84	73
100-6-5.5	60	81	88	93	96	92	85	74
100-8-3	53	74	81	86	89	85	78	67
100-8-4	54	75	82	87	90	86	79	68
100-8-7.5	53	74	81	86	89	85	78	67
100-8-9	53	74	81	86	89	85	78	67
100-8-14	54	75	82	87	90	86	79	68
100-12-3	43	64	71	76	79	75	68	57
100-12-4	44	65	72	77	80	76	69	58
100-12-5.5	45	66	73	78	81	77	70	59
125-4T/3-10	66	73	84	94	95	90	82	78
125-4T/3-15	67	74	85	95	96	91	83	79
125-4T/3-20	69	76	87	97	98	93	85	81
125-4T/6-15	63	72	87	94	97	91	85	81
125-4T/6-20	63	72	87	94	97	91	85	81
125-4T/9-20	62	71	87	93	95	89	84	80
125-6T/6-5.5	56	66	78	81	83	79	68	64
125-6T/6-7.5	56	66	78	81	83	79	68	64
125-6T/6-10	58	68	80	83	85	81	70	66
125-6T/6-15	60	70	82	85	87	83	72	68
125-6T/9-7.5	54	65	79	83	83	81	70	66
125-6T/9-10	54	65	79	83	83	81	70	66
125-6T/9-15	57	68	82	86	86	84	73	69
125-6T/9-20	60	71	85	89	89	87	76	72
125-8T/6-4	50	59	70	75	75	69	58	54
125-8T/6-5.5	52	61	72	77	77	71	60	56
125-8T/6-7.5	54	63	74	79	79	73	62	58
125-8T/6-10	55	64	75	80	80	74	63	59
125-8T/9-5.5	49	61	70	76	78	72	61	57
125-8T/9-7.5	52	64	73	79	81	75	64	60
125-8T/9-10	54	66	75	81	83	77	66	62
125-8T/9-15	55	67	76	82	84	78	67	63

Values taken at outlet with maximum airflow.

Model	63	125	250	500	1000	2000	4000	8000
56-4-1	43	64	71	76	79	75	68	57
56-4-1.5	44	65	72	77	80	76	69	58
56-6-0.75	33	54	61	66	69	65	58	47
56-8-1.5	29	50	57	62	65	61	54	43
63-4-1.5	46	67	74	79	82	78	71	60
63-4-2	47	68	75	80	83	79	72	61
63-4-3	48	69	76	81	84	80	73	62
63-6-0.75	38	59	66	71	74	70	63	52
63-6-1	39	60	67	72	75	71	64	53
63-8-1.5	31	52	59	64	67	63	56	45
63-8-2	32	53	60	65	68	64	57	46
63-8-3	33	54	61	66	69	65	58	47
71-4-2	50	71	78	83	86	82	75	64
71-4-3	52	73	80	85	88	84	77	66
71-4-4	53	74	81	86	89	85	78	67
71-6-1	40	61	68	73	76	72	65	54
71-6-1.5	41	62	69	74	77	73	66	55
71-8-2	35	56	63	68	71	67	60	49
71-8-3	37	58	65	70	73	69	62	51
71-8-4	38	59	66	71	74	70	63	52
80-4-4	54	75	82	87	90	86	79	68
80-4-5.5	55	76	83	88	91	87	80	69
80-6-1.5	44	65	72	77	80	76	69	58
80-6-2	45	66	73	78	81	77	70	59
80-6-3	46	67	74	79	82	78	71	60
80-8-1	44	65	72	77	80	76	69	58
80-8-4	39	60	67	72	75	71	64	53
80-8-5.5	40	61	68	73	76	72	65	54
90-4-5.5	60	81	88	93	96	92	85	74
90-4-7.5	62	83	90	95	98	94	87	76
90-4-9	63	84	91	96	99	95	88	77
90-4-10	63	84	91	96	99	95	88	77
90-6-3	50	71	78	83	86	82	75	64
90-6-4	51	72	79	84	87	83	76	65
90-8-1	44	65	72	77	80	76	69	58
90-8-2	46	67	74	79	82	78	71	60
90-8-5.5	45	66	73	78	81	77	70	59
90-8-7.5	47	68	75	80	83	79	72	61
90-8-9	48	69	76	81	84	80	73	62
90-12-3	35	56	63	68	71	67	60	49
90-12-4	36	57	64	69	72	68	61	50
100-4-7.5	65	86	93	98	101	97	90	79
100-4-9	65	86	93	98	101	97	90	79
100-4-10	66	87	94	99	102	98	91	80
100-4-14	66	87	94	99	102	98	91	80
100-4-15	67	88	95	100	103	99	92	81
100-6-3	56	77	84	89	92	88	81	70
100-6-4	57	78	85	90	93	89	82	71
100-6-5.5	58	79	86	91	94	90	83	72
100-8-3	52	73	80	85	88	84	77	66
100-8-4	53	74	81	86	89	85	78	67
100-8-7.5	50	71	78	83	86	82	75	64
100-8-9	50	71	78	83	86	82	75	64
100-8-14	51	72	79	84	87	83	76	65
100-12-3	41	62	69	74	77	73	66	55
100-12-4	42	63	70	75	78	74	67	56
100-12-5.5	43	64	71	76	79	75	68	57
125-4T/3-10	63	70	81	91	92	87	79	75
125-4T/3-15	64	71	82	92	93	88	80	76
125-4T/3-20	66	73	84	94	95	90	82	78
125-4T/6-15	60	69	84	91	94	88	82	78
125-4T/6-20	60	69	84	91	94	88	82	78
125-4T/9-20	59	68	84	90	92	86	81	77
125-6T/6-5.5	54	64	76	79	81	77	66	62
125-6T/6-7.5	54	64	76	79	81	77	66	62
125-6T/6-10	56	66	78	81	83	79	68	64
125-6T/6-15	58	68	80	83	85	81	70	66
125-6T/9-7.5	52	63	77	81	81	79	68	64
125-6T/9-10	52	63	77	81	81	79	68	64
125-6T/9-15	55	66	80	84	84	82	71	67
125-6T/9-20	58	69	83	87	87	85	74	70
125-8T/6-4	49	58	69	74	74	68	57	53
125-8T/6-5.5	51	60	71	76	76	70	59	55
125-8T/6-7.5	53	62	73	78	78	72	61	57
125-8T/6-10	54	63	74	79	79	73	62	58
125-8T/9-5.5	48	60	69	75	77	71	60	56
125-8T/9-7.5	51	63	72	78	80	74	63	59
125-8T/9-10	53	65	74	80	82	76	65	61
125-8T/9-15	54	66	75	81	83	77	66	62



Erp. BEP (best efficiency point) characteristics

MC	Measurement category	ne[%]	Efficiency
EC	Efficiency category	N	Degree of efficiency
	S Static	[kW]	Electrical power
	T Total	[m³/h]	Airflow
VSD	Variable-speed drive	[mmH₂O]	Static or total pressure (According to EC)
SR	Specific relationship	[RPM]	Speed

Model	MC	EC	VSD	SR	ne [%]	N	[kW]	[m ³ /h]	[mmH ₂ O]	[RPM]
HTMH-56-4T-1	C	S	NO	1.00	35.4%	42.1	0.85	7901	14.07	1418
HTMH-56-4T-1.5	B	T	NO	1.00	48.5%	54.4	1.16	11340	18.14	1414
HTMH-56-4/8T-1.5	B	T	NO	1.00	44.9%	50.5	1.33	11588	18.94	1445
HTMH-56-6T-0.75	B	T	NO	1.00	42.7%	50.8	0.52	9212	8.77	934
HTMH-63-4T-1.5	C	S	NO	1.00	48.2%	54.3	1.11	10387	18.88	1418
HTMH-63-4/8T-1.5	C	S	NO	1.00	41.3%	46.8	1.38	10605	19.68	1447
HTMH-63-4T-2	C	S	NO	1.00	42.4%	47.6	1.54	12016	20.00	1449
HTMH-63-4/8T-2	C	S	NO	1.00	37.2%	42.1	1.70	11892	19.59	1434
HTMH-63-4T-3	B	T	NO	1.00	62.4%	66.6	2.19	19423	25.86	1446
HTMH-63-4/8T-3	B	T	NO	1.00	56.0%	59.9	2.42	19373	25.73	1442
HTMH-63-6T-0.75	B	T	NO	1.00	56.1%	64.1	0.55	11393	9.86	937
HTMH-63-6T-1	B	T	NO	1.00	54.9%	61.8	0.80	13916	11.57	939
HTMH-71-4T-2	C	S	NO	1.00	48.5%	53.8	1.49	13409	19.84	1450
HTMH-71-4/8T-2	C	S	NO	1.00	42.6%	47.5	1.65	13275	19.45	1436
HTMH-71-4T-3	C	S	NO	1.00	44.7%	48.9	2.16	16356	21.67	1446
HTMH-71-4/8T-3	C	S	NO	1.00	40.1%	44.0	2.39	16314	21.56	1443
HTMH-71-4T-4	B	T	NO	1.00	68.4%	71.8	2.87	23676	30.48	1434
HTMH-71-4/8T-4	B	T	NO	1.00	61.6%	64.8	3.24	23797	30.80	1441
HTMH-71-6T-1	B	T	NO	1.00	62.4%	69.3	0.82	14945	12.60	938
HTMH-71-6T-1.5	B	T	NO	1.00	59.2%	65.1	1.15	18001	13.88	939
HTMH-80-4T-4	C	S	NO	1.00	46.9%	50.1	3.22	20108	27.62	1426
HTMH-80-4/8T-4	C	S	NO	1.00	42.3%	45.1	3.64	20222	27.93	1434
HTMH-80-4T-5.5	C	S	NO	1.00	45.5%	47.7	4.55	23694	32.11	1441
HTMH-80-4/8T-5.5	C	S	NO	1.00	43.3%	45.4	4.70	23552	31.72	1432
HTMH-80-6T-1.5	C	S	NO	1.00	38.9%	44.4	1.36	15261	12.68	928
HTMH-80-6T-2	B	T	NO	1.00	61.3%	65.9	1.85	24165	17.21	941
HTMH-80-6T-3	B	T	NO	1.00	64.9%	68.9	2.29	26615	20.53	961
HTMH-80-8T-1	B	T	NO	1.00	51.2%	57.2	1.13	18865	11.24	705
HTMH-90-4T-5.5	C	S	NO	1.00	51.0%	53.2	4.50	27512	30.65	1441
HTMH-90-4/8T-5.5	C	S	NO	1.00	48.6%	50.7	4.64	27348	30.28	1433
HTMH-90-4T-7.5	C	S	NO	1.00	47.8%	49.1	6.35	31725	35.17	1459
HTMH-90-4/8T-7.5	C	S	NO	1.00	43.0%	44.0	6.93	31525	34.73	1450
HTMH-90-4T-10 IE3	C	S	NO	1.01	46.3%	47.0	7.81	35188	37.75	1466
HTMH-90-4/8T-9	C	S	NO	1.00	43.0%	43.6	7.86	33548	36.97	1462
HTMH-90-6T-3	C	S	NO	1.00	42.8%	46.8	2.40	23147	16.33	959
HTMH-90-6/12T-3	C	S	NO	1.00	37.5%	41.2	2.64	22863	15.94	947
HTMH-90-6T-4	B	T	NO	1.00	63.7%	66.9	3.21	32972	22.77	964
HTMH-90-6/12T-4	B	T	NO	1.00	55.3%	58.1	3.70	32972	22.77	964
HTMH-90-8T-1	C	S	NO	1.00	36.4%	42.7	1.04	15838	8.76	708
HTMH-90-8T-2	B	T	NO	1.00	58.5%	63.9	1.40	24325	12.38	718
HTMH-100-4T-7.5	C	S	NO	1.00	50.5%	51.7	6.31	33024	35.42	1460
HTMH-100-4/8T-7.5	C	S	NO	1.00	45.4%	46.4	6.89	32817	34.98	1450
HTMH-100-4T-10 IE3	C	S	NO	1.00	49.0%	49.6	8.18	37734	39.02	1465
HTMH-100-4/8T-9	C	S	NO	1.00	45.8%	46.4	7.93	35548	37.50	1462
HTMH-100-4T-15 IE3	C	S	NO	1.01	44.9%	44.8	11.93	44732	43.97	1470
HTMH-100-4/8T-14	C	S	NO	1.01	39.0%	38.8	14.13	45164	44.82	1469
HTMH-100-6T-3	C	S	NO	1.00	45.4%	49.2	2.51	24808	16.87	957
HTMH-100-6/12T-3	C	S	NO	1.00	39.8%	43.3	2.75	24492	16.44	945
HTMH-100-6T-4	C	S	NO	1.00	41.1%	43.8	3.72	29458	19.07	958
HTMH-100-6/12T-4	C	S	NO	1.00	35.7%	38.0	4.29	29458	19.07	958
HTMH-100-6T-5.5	B	T	NO	1.00	61.3%	63.3	4.86	44005	24.89	959
HTMH-100-6/12T-5.5	B	T	NO	1.00	56.5%	58.2	5.44	44437	25.38	968
HTMH-100-8T-3	B	T	NO	1.00	52.5%	56.2	2.67	33957	15.20	709
HTMH-100-8T-4	B	T	NO	1.00	54.2%	57.8	2.77	41581	13.28	718
HTMH-125-4T/3-10 IE3	C	S	NO	1.00	52.3%	53.2	7.59	41511	35.13	1468
HTMH-125-4T/3-15 IE3	C	S	NO	1.01	56.1%	56.0	11.80	57655	42.19	1471



Erp. BEP (best efficiency point) characteristics

Model	MC	EC	VSD	SR	η_e [%]	N	[kW]	[m ³ /h]	[mmH ₂ O]	[RPM]
HTMH-125-4T/3-20 IE3	C	S	NO	1.01	55.2%	54.9	15.29	67316	46.06	1472
HTMH-125-4T/6-15 IE3	C	S	NO	1.01	57.8%	57.8	11.81	48508	51.71	1471
HTMH-125-4T/6-20 IE3	C	S	NO	1.01	56.9%	56.7	14.20	52757	56.25	1474
HTMH-125-4T/9-20 IE3	C	S	NO	1.01	70.4%	70.1	17.44	37304	120.90	1474
HTMH-125-6T/6-5.5	C	S	NO	1.00	53.1%	55.5	4.28	34565	24.14	972
HTMH-125-6T/6-7.5	C	S	NO	1.00	54.7%	56.3	5.53	41832	26.55	974
HTMH-125-6T/6-10 IE3	C	S	NO	1.00	55.2%	55.9	7.84	53067	29.95	972
HTMH-125-6T/6-15 IE3	C	S	NO	1.00	51.2%	51.2	11.09	61349	34.01	972
HTMH-125-6T/9-7.5	C	S	NO	1.00	57.2%	58.8	5.67	36967	32.26	973
HTMH-125-6T/9-10 IE3	C	S	NO	1.00	55.1%	56.2	6.74	48390	28.19	976
HTMH-125-6T/9-15 IE3	C	S	NO	1.00	50.9%	50.9	11.00	61885	33.25	973
HTMH-125-6T/9-20 IE3	C	S	NO	1.01	49.7%	49.5	15.00	69606	39.35	968
HTMH-125-8T/6-4	C	S	NO	1.00	47.4%	50.3	3.53	38680	15.89	709
HTMH-125-8T/6-5.5	C	S	NO	1.00	46.8%	49.1	4.42	42659	17.80	715
HTMH-125-8T/6-7.5	C	S	NO	1.00	45.5%	47.0	5.87	50667	19.37	727
HTMH-125-8T/6-10	B	T	NO	1.00	65.4%	66.1	7.79	65294	28.66	727
HTMH-125-8T/9-5.5	C	S	NO	1.00	44.6%	46.7	4.79	43462	18.07	712
HTMH-125-8T/9-7.5	C	S	NO	1.00	46.5%	48.0	5.75	48507	20.26	728
HTMH-125-8T/9-10	C	S	NO	1.00	45.9%	46.7	7.65	55731	23.16	728
HTMH-125-8T/9-15	B	T	NO	1.00	67.6%	67.6	10.90	72088	37.51	728

Best efficiency point data of the internal fan

Dimensions in mm

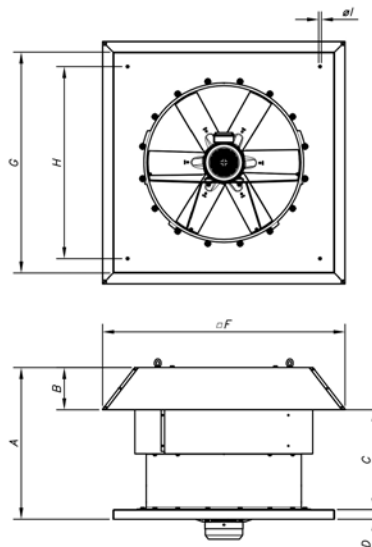

Model	A	B	C	D	F	G	H	I
HTMH-56	650	185	465	40	960	900	750	14
HTMH-63	680	215	465	40	1092	1000	850	14
HTMH-71	760	195	565	40	1120	1000	850	14
HTMH-80	790	215	575	50	1252	1150	1000	14
HTMH-90	910	232	678	50	1380	1150	1000	14
HTMH-100	1055	252	803	50	1527	1250	1100	14
HTMH-125	1170	310	859	50	1802	1600	1450	17

Characteristic Curves

Q = Airflow in m³/h, m³/s and cfm.

Pe = Static pressure in mmH₂O, Pa and inwg.

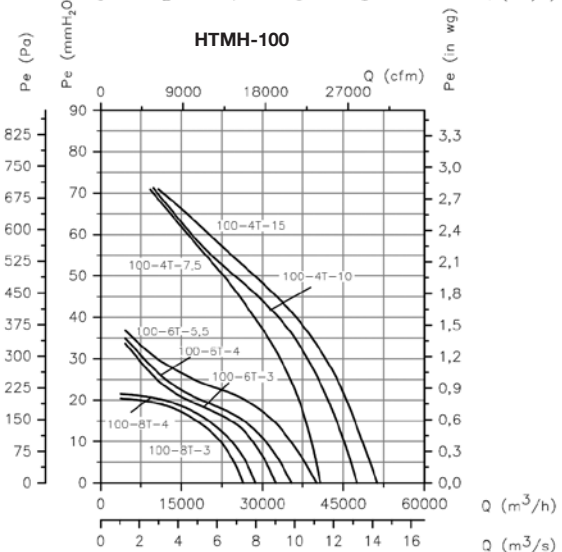
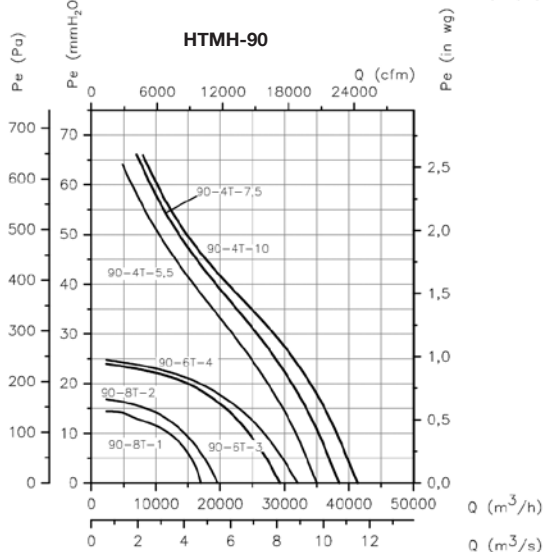
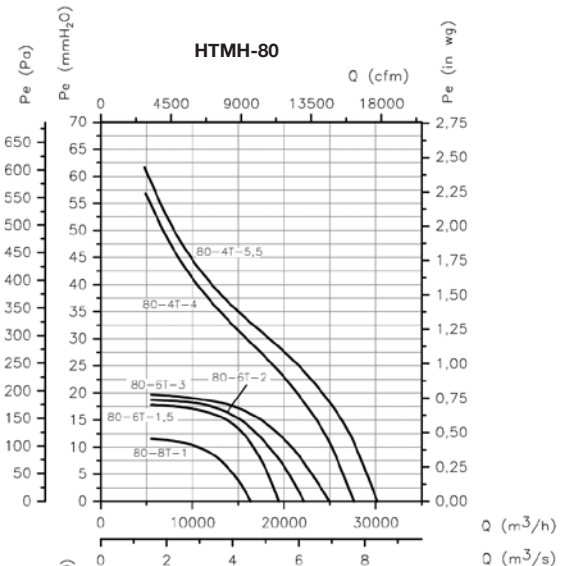
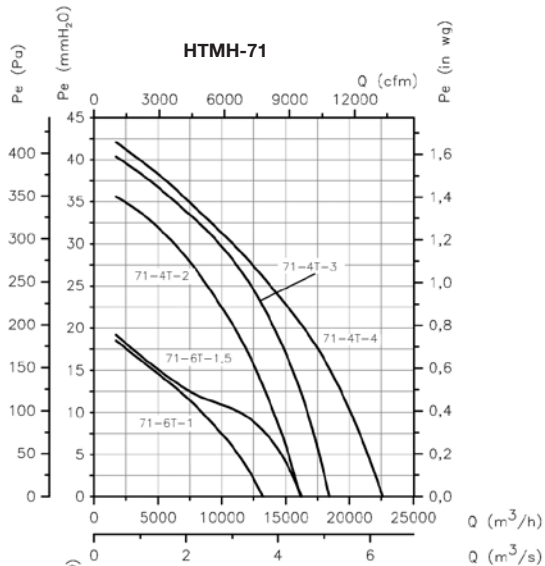
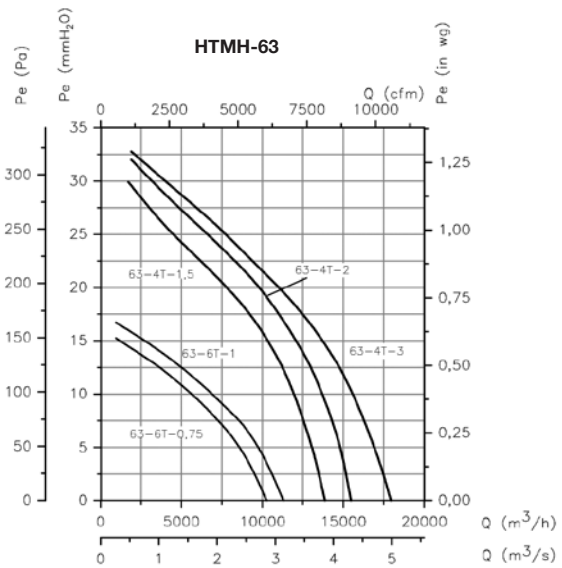
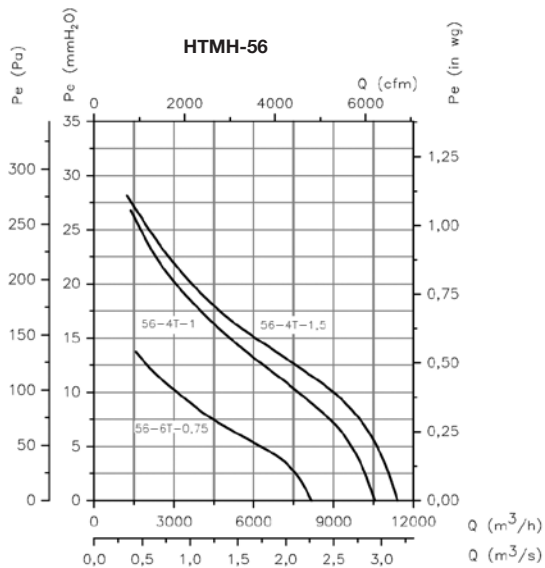

Characteristic Curves

Q = Airflow in m³/h, m³/s and cfm.

Pe = Static pressure in mmH₂O, Pa and inwg.

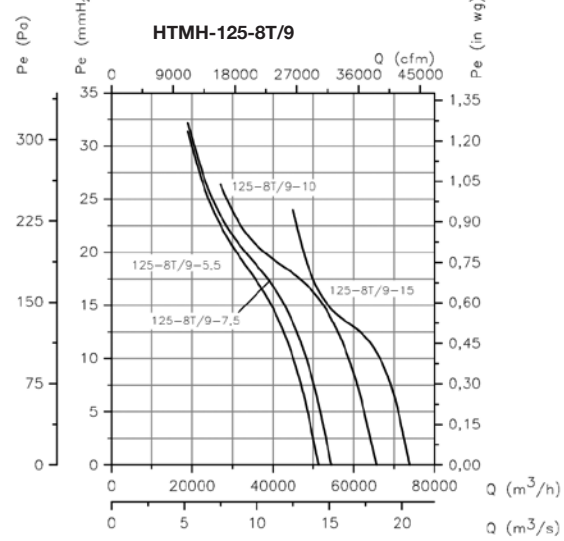
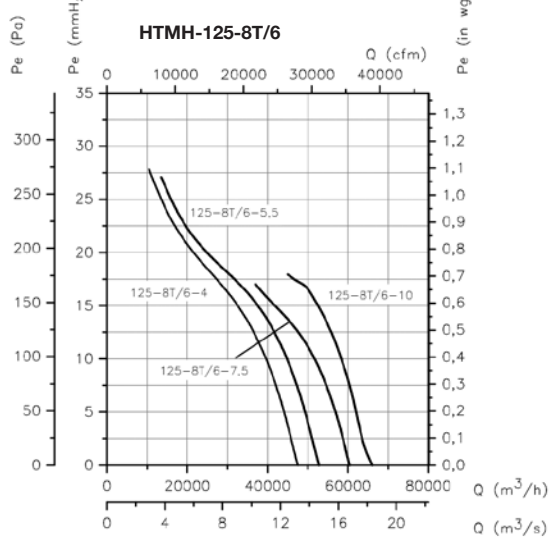
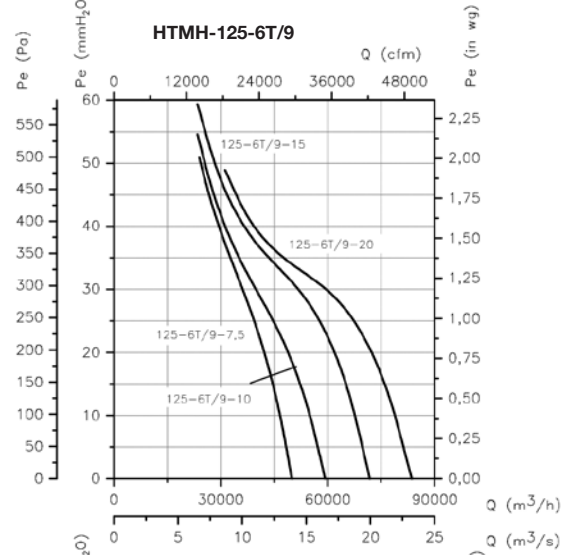
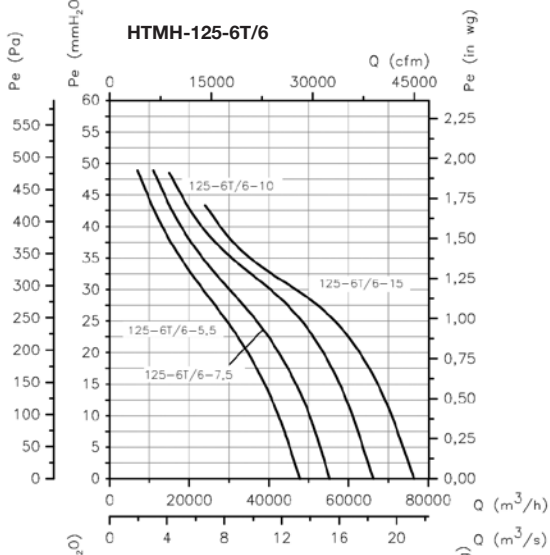
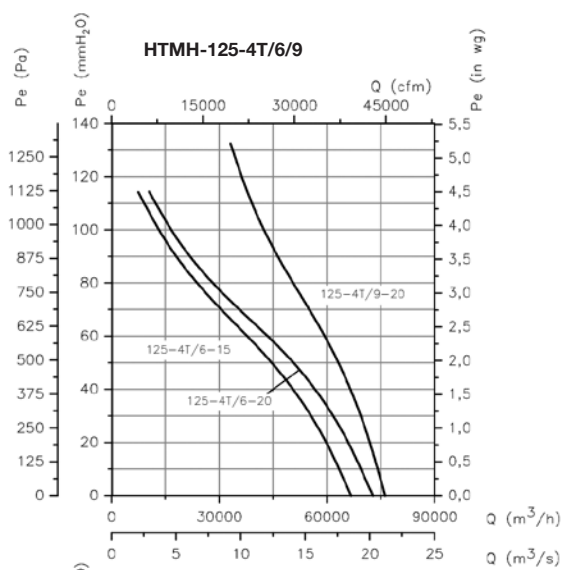
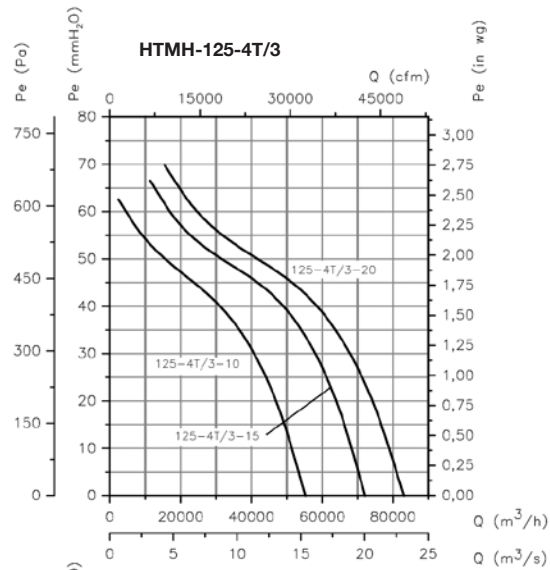

Sound pressure validation over distance

The sound level may vary depending on the roof structure.

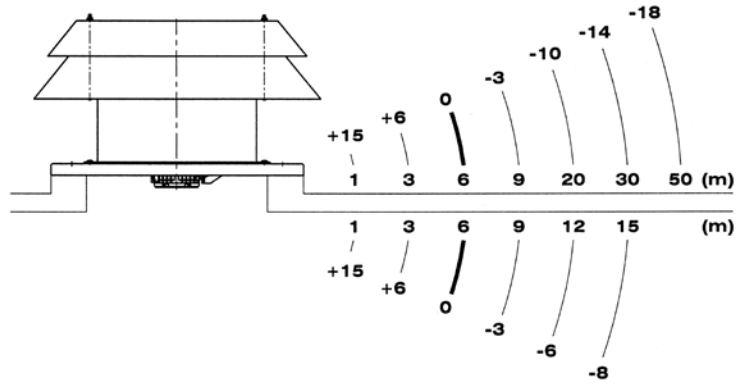

Accessories

See accessories section



Axial roof fans with flat base



Axial roof fans with plastic fibreglass-reinforced impeller, with flat base for roof mounting.



Fan:

- Galvanised sheet steel base plate
- Impellers in polyamide 6 reinforced with fibreglass, except for 4-pole 100 models in aluminium.
- Bird guard
- Sheet steel rain deflector hood with anticorrosive protection, except models 80, 90, 100 which come in polyester
- Airflow direction from motor to impeller

Motor:

- IE2 efficiency motors for capacities equal to or over 0.75kW and below 7.5kW, except single-phase, 2 speed and 8 pole motors.
- IE3 efficiency motors for capacities equal to or over 7.5kW, except single-phase, 2 speed and 8 pole motors.
- Class F motors, with ball bearings and IP55 protection, except single-phase versions from size 45 to size 63, IP54 protection.
- Single-phase 220-240V-50Hz. and three-phase 220-240V/380-415V-50Hz. (up to 4kW.) and 400/690V.-50Hz. (power over 4kW.)
- Max. air temperature to transport: -25°C + 60°C

Finish:

- Anticorrosive finish in polyester resin polymerised at 190°C, after degreasing with phosphate-free nanotechnology treatment.

On request:

- IE2 and IE3 efficiency motors for any power.
- Possibility of supply as IMPULSION FANS
- AL version cast aluminium impellers.
- Special windings for different voltages
- ATEX certification, Category 2



Order code



HT
Axial roof fans with flat base

25
Impeller diameter in cm.

4T
Number of motor poles
2=2900 r/min. 50 Hz
4=1400 r/min. 50 Hz
6=750 r/min. 50 Hz

I
M=Single-phase
T=Three-phase

A
I: Extraction fans
A: Impulsion fans

BS: High base plate
BSS: High base plate with silencer.

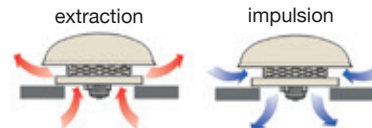

Technical characteristics

Model	Speed (r/min)	Maximum admissible current (A)			Installed capacity (kW)	Maximum airflow (m³/h)	Sound pressure level dB(A)		Approx. weight (Kg)
		230V	400V	690V			Inlet	Outlet	
HT-25-4T	1320	0.65	0.38		0.09	1080	41	40	12.5
HT-25-4M	1380	0.65			0.10	1080	41	40	12.5
HT-31-4T	1320	0.65	0.38		0.09	1800	47	46	13.3
HT-31-4M	1370	0.83			0.09	1800	47	46	13.5
HT-35-4T	1320	0.65	0.38		0.09	2600	48	47	17.5
HT-35-4M	1370	0.83			0.09	2600	48	47	17.5
HT-40-4T	1350	1.66	0.96		0.25	4600	51	50	21.0
HT-40-4M	1370	2.00			0.25	4600	51	50	21.0
HT-45-4T	1370	2.02	1.17		0.37	6500	55	53	29.0
HT-45-4M	1400	2.76			0.37	6500	55	54	30.5
HT-50-4T	1380	2.92	1.69		0.55	8500	59	57	36.0
HT-50-4M	1350	4.40			0.55	8500	59	57	39.0
HT-56-4T	1410	3.10	1.79		0.75	9800	61	57	35.0
HT-56-4M	1410	5.05			0.75	9800	61	57	37.0
HT-56-6T	900	1.51	0.87		0.25	6600	48	46	46.0
HT-56-6M	900	2.07			0.25	6600	48	46	46.0
HT-63-4T	1400	4.03	2.32		1.10	14000	63	59	65.8
HT-63-6T	900	2.24	1.30		0.37	9200	52	49	61.8
HT-63-6M	900	2.69			0.37	9200	52	49	61.8
HT-71-4T	1430	5.96	3.44		1.50	18000	69	67	64.0
HT-71-6T	900	2.99	1.73		0.55	12200	58	56	64.9

Technical characteristics

Model	Speed (r/min)	Maximum admissible current (A)			Installed capacity (kW)	Maximum airflow (m ³ /h)	Sound pressure level dB(A)		Approx. weight (Kg)
		230V	400V	690V			Inlet	Outlet	
HT-71-6M	900	3.84			0.55	12200	58	56	64.9
HT-80-4T	1445	8.36	4.83		2.20	26200	73	70	87.8
HT-80-6T	945	4.88	2.82		1.10	18000	64	61	81.8
HT-90-4T	1445	10.96	6.33		3.00	31500	77	74	94.0
HT-90-6T	955	6.42	3.71		1.50	21200	68	65	91.0
HT-100-4T-7.5	1440		11.60	6.72	5.50	37000	80	77	114.0
HT-100-4T-10 IE3	1465		13.90	8.06	7.50	44000	84	81	141.0
HT-100-6T-2	955	6.42	3.71		1.50	25000	71	68	102.0
HT-100-6T-3	955	9.30	5.30		2.20	28200	75	72	106.0
HT-100-8T-1.5	705	5.63	3.25		1.10	19050	64	61	103.0
HT-100-8T-2	705	7.10	4.10		1.50	21100	66	63	114.0



Erp. BEP (best efficiency point) characteristics

MC	Measurement category	ηe[%]	Efficiency
EC	Efficiency category	N	Degree of efficiency
S	Static	[kW]	Electrical power
T	Total	[m³/h]	Airflow
VSD	Variable-speed drive	[mmH₂O]	Static or total pressure (According to EC)
SR	Specific relationship	[RPM]	Speed

Model	MC	EC	VSD	SR	ηe [%]	N	[kW]	[m ³ /h]	[mmH ₂ O]	[RPM]
HT-25-4T	-	-	-	-	-	-	0.099	586	3.45	1358
HT-25-4M	-	-	-	-	-	-	0.102	566	3.59	1386
HT-31-4T	-	-	-	-	-	-	0.103	1013	4.06	1397
HT-31-4M	-	-	-	-	-	-	0.111	1004	4.09	1418
HT-35-4T	-	-	-	-	-	-	0.125	1857	6.94	1375
HT-35-4M	A	S	NO	1.00	28.0%	40.0	0.126	1851	6.96	1422
HT-40-4T	A	S	NO	1.00	32.0%	41.7	0.289	3401	10.00	1396
HT-40-4M	A	S	NO	1.00	31.0%	40.6	0.299	3399	10.01	1405
HT-45-4T	A	S	NO	1.00	33.4%	41.8	0.475	4228	13.80	1392
HT-45-4M	A	S	NO	1.00	32.3%	40.5	0.494	4257	13.73	1417
HT-50-4T	B	T	NO	1.00	53.4%	60.6	0.733	9635	14.91	1395
HT-50-4M	B	T	NO	1.00	51.3%	58.4	0.763	9642	14.90	1411
HT-56-4T	B	T	NO	1.00	66.7%	74.0	0.700	12713	13.47	1433
HT-56-4M	B	T	NO	1.00	56.7%	63.6	0.824	12698	13.49	1445
HT-56-6T	A	S	NO	1.00	31.4%	41.7	0.237	3564	7.69	919
HT-63-4T	C	S	NO	1.00	45.3%	51.1	1.179	10593	18.50	1412
HT-63-6T	C	S	NO	1.00	32.7%	41.1	0.474	6417	8.88	921
HT-63-6M	C	S	NO	1.00	32.2%	40.6	0.482	6339	8.99	915
HT-71-4T	C	S	NO	1.00	50.1%	55.3	1.508	13256	20.95	1442
HT-71-6T	C	S	NO	1.00	35.7%	43.0	0.710	8036	11.60	913
HT-71-6M	C	S	NO	1.00	33.6%	40.7	0.755	7945	11.73	908
HT-80-4T	C	S	NO	1.00	56.7%	60.7	2.309	16178	29.73	1451
HT-80-6T	C	S	NO	1.00	46.7%	52.1	1.380	15312	15.45	946
HT-90-4T	C	S	NO	1.00	58.1%	61.1	3.362	20308	35.36	1447
HT-90-6T	C	S	NO	1.00	50.9%	55.7	1.777	18106	18.37	957
HT-100-4T-7.5	C	S	NO	1.00	51.0%	52.4	5.965	27281	40.95	1443
HT-100-4T-10 IE3	C	S	NO	1.00	48.4%	49.1	7.832	36164	38.48	1467
HT-100-6T-2	C	S	NO	1.00	47.5%	52.5	1.619	19961	14.14	953
HT-100-6T-3	C	S	NO	1.00	47.3%	51.1	2.461	23849	17.92	959
HT-100-8T-1.5	C	S	NO	1.00	47.6%	52.9	1.452	19345	13.11	707
HT-100-8T-2	C	S	NO	1.00	42.7%	47.2	1.923	20901	14.42	706

Best efficiency point data of the internal fan

Acoustic features

The specified values are determined according to free field measurements of pressure and sound levels in dB(A) at a distance of 6 m.

Sound power Lw(A) spectrum in dB(A) via frequency band in Hz.

Values taken at inlet with maximum airflow (Qmax)

Model	63	125	250	500	1000	2000	4000	8000
25	27	37	54	54	62	58	51	42
31	33	43	60	60	68	64	57	48
35	34	44	61	61	69	65	58	49
40	28	45	57	65	70	70	66	59
45	32	49	61	69	74	74	70	63
50	36	53	65	73	78	78	74	67
56-4	38	55	67	75	80	80	76	69
56-6	25	42	54	62	67	67	63	56
63-4	40	57	69	77	82	82	78	71
63-6	29	46	58	66	71	71	67	60
71-4	46	63	75	83	88	88	84	77
71-6	35	52	64	72	77	77	73	66
80-4	57	78	85	90	93	89	82	71
80-6	48	69	76	81	84	80	73	62
90-4	61	82	89	94	97	93	86	75
90-6	52	73	80	85	88	84	77	66
100-4-7.5	64	85	92	97	100	96	89	78
100-4-10	68	89	96	101	104	100	93	82
100-6-2	55	76	83	88	91	87	80	69
100-6-3	59	80	87	92	95	91	84	73
100-8-1.5	48	69	76	81	84	80	73	62
100-8-2	50	71	78	83	86	82	75	64

Values taken at outlet with maximum airflow (Qmax)

Model	63	125	250	500	1000	2000	4000	8000
25	26	36	53	53	61	57	50	41
31	32	42	59	59	67	63	56	47
35	33	43	60	60	68	64	57	48
40	27	44	56	64	69	69	65	58
45	30	47	59	67	72	72	68	61
50	34	51	63	71	76	76	72	65
56-4	34	51	63	71	76	76	72	65
56-6	23	40	52	60	65	65	61	54
63-4	36	53	65	73	78	78	74	67
63-6	26	43	55	63	68	68	64	57
71-4	44	61	73	81	86	86	82	75
71-6	33	50	62	70	75	75	71	64
80-4	54	75	82	87	90	86	79	68
80-6	45	66	73	78	81	77	70	59
90-4	58	79	86	91	94	90	83	72
90-6	49	70	77	82	85	81	74	63
100-4-7.5	61	82	89	94	97	93	86	75
100-4-10	65	86	93	98	101	97	90	79
100-6-2	52	73	80	85	88	84	77	66
100-6-3	56	77	84	89	92	88	81	70
100-8-1.5	45	66	73	78	81	77	70	59
100-8-2	47	68	75	80	83	79	72	61

Dimensions in mm

Model	A	B	C	D	E	ØF	G	H	ØI	ØJ
HT-25	400	176	44	40	140	620	450	360	12	346
HT-31	423	176	67	40	140	620	500	410	12	416
HT-35	472	228	64	40	140	770	560	450	12	486
HT-40	478	228	82	40	128	770	630	530	12	536
HT-45-4T	550	266	88	50	146	960	710	590	12	596
HT-45-4M	512	266	88	50	108	960	710	590	12	596
HT-50-4T	575	296	83	50	146	1090	800	680	12	676
HT-50-4M	558	296	83	50	129	1090	800	680	12	676
HT-56-4T	607	296	117	40	154	1090	900	750	14	758
HT-56-4M	590	296	117	40	137	1090	900	750	14	758
HT-56-6	589	296	117	40	136	1090	900	750	14	758
HT-63-4	714	357	136	40	182	1285	1000	850	14	735
HT-63-6	667	357	136	40	135	1285	1000	850	14	735
HT-71-4T	740	357	166	40	178	1285	1000	850	14	815
HT-71-6	689	357	166	40	178	1285	1000	850	14	815
HT-80-4	840	357	244	50	189	1285	1150	1000	14	905
HT-80-6	804	357	244	50	153	1285	1150	1000	14	905
HT-90-4	892	440	213	50	189	1580	1150	1000	14	1020
HT-90-6	896	440	213	50	193	1580	1150	1000	14	1020
HT-100-4T	997	440	284	50	223	1580	1250	1100	14	1120
HT-100-6T-2	940	440	284	50	166	1580	1250	1100	14	1120
HT-100-6T-3	957	440	284	50	183	1580	1250	1100	14	1120
HT-100-8T-1.5	940	440	284	50	166	1580	1250	1100	14	1120
HT-100-8T-2	957	440	284	50	183	1580	1250	1100	14	1120

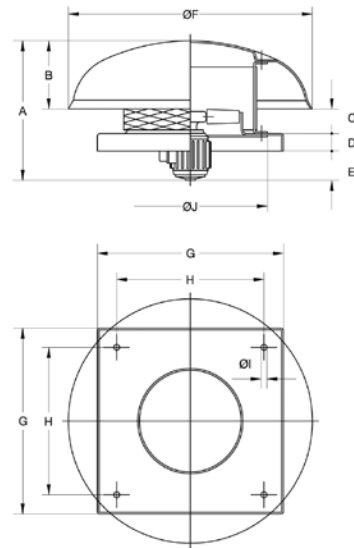

Characteristic Curves

Q = Airflow in m³/h, m³/s and cfm.

Pe= Static pressure in mmH₂O, Pa and inwg.

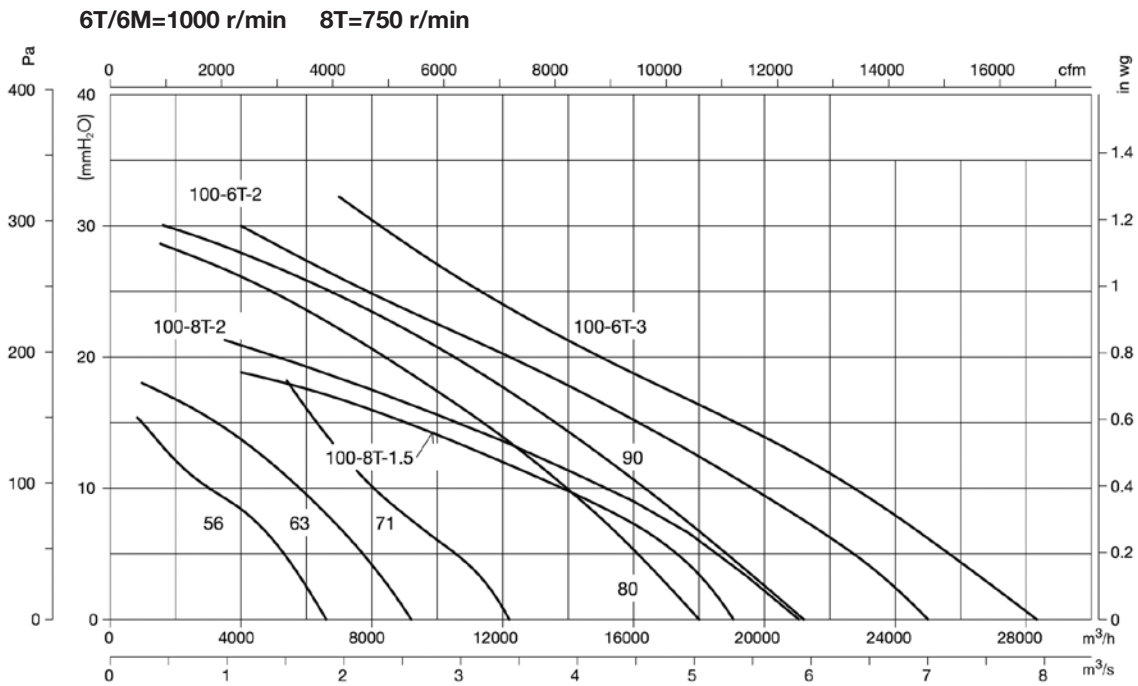
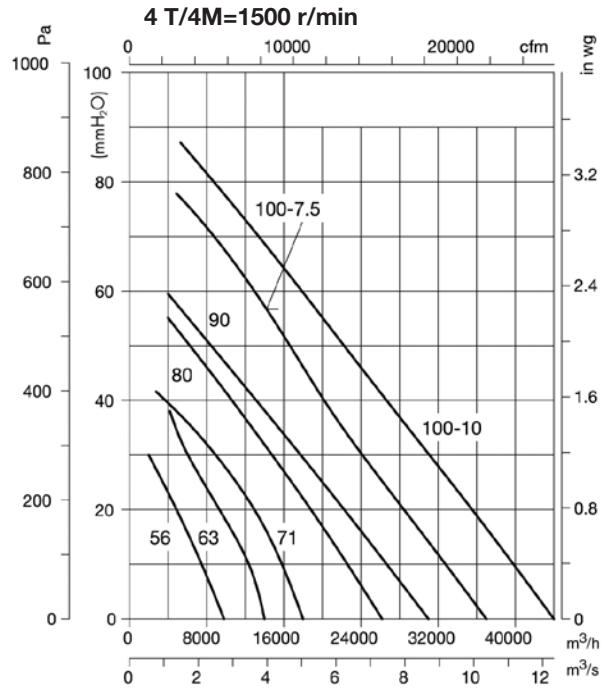
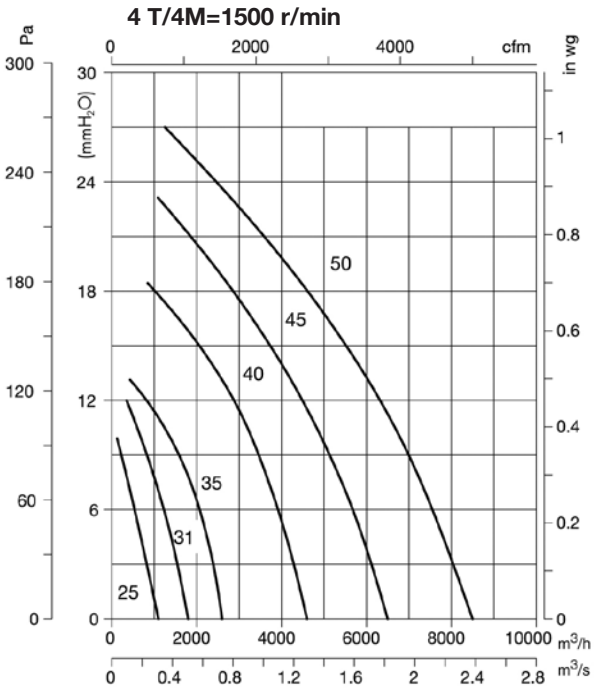

Accessories

See accessories section.



HTTI



Axial roof fans with sloping base

Axial roof fans adapted to the roof slope, with built-in safety switch.



Fan:

- Galvanised sheet steel base plate.
- Impellers in polyamide 6 reinforced with fibre glass
- Rain deflector hood
- Airflow direction from motor to impeller

Motor:

- IE2 efficiency motors for capacities equal to or over 0.75kW and below 7.5kW, except single-phase, 2 speed and 8 pole motors.
- IE3 efficiency motors for capacities equal to or over 7.5kW, except single-phase, 2 speed and 8 pole motors.
- Class F motors, with ball bearings, IP55 protection
- Three-phase 230/400V-50Hz. (up to 4kW) and 400/690V-50Hz. (power over 4kW)
- Max. air temperature to transport: -25°C + 60°C

Finish:

- Anticorrosive galvanized sheet steel

On request:

- IE2 and IE3 efficiency motors for any power.
- All the angles and base plate measurements required (max. length 2m)
- Made from stainless steel sheet
- Special windings for different voltages
- ATEX certification, Category 2

Order code

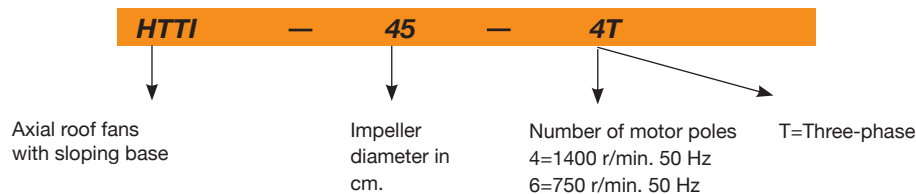

Technical characteristics

Model	Speed (r/min)	Maximum admissible current (A)			Installed capacity (kW)	Maximum airflow (m³/h)	Sound pressure level dB(A)	Approx. weight (Kg)
		230V	400V	690V				
HTTI-45-4T	1370	2.02	1.17		0.37	6570	66	45.7
HTTI-50-4T	1380	2.92	1.69		0.55	9200	69	56.0
HTTI-50-6T	900	2.24	1.30		0.37	5680	59	59.5
HTTI-56-4T	1400	4.03	2.32		1.10	11700	72	64.4
HTTI-56-6T	900	2.24	1.30		0.37	7560	61	64.0
HTTI-63-4T	1400	4.03	2.32		1.10	14800	74	70.9
HTTI-63-6T	900	2.24	1.30		0.37	11160	64	70.0
HTTI-71-4T	1430	5.96	3.44		1.50	18900	78	82.0
HTTI-71-6T	900	2.99	1.73		0.55	13500	67	78.5
HTTI-80-4T	1445	10.96	6.33		3.00	33300	83	114.4
HTTI-80-6T	945	4.88	2.82		1.10	23400	72	103.8
HTTI-90-4T	1440	14.10	8.12		4.00	41850	89	137.0
HTTI-90-6T	955	6.42	3.71		1.50	30870	77	129.0
HTTI-100-4T IE3	1465		13.90	8.06	7.50	56700	93	197.0
HTTI-100-6T	955	9.30	5.30		2.20	34200	82	149.8



Erp. BEP (best efficiency point) characteristics

MC	Measurement category	ηe [%]	Efficiency
EC	Efficiency category	N	Degree of efficiency
	S Static	[kW]	Electrical power
	T Total	[m³/h]	Airflow
VSD	Variable-speed drive	[mmH₂O]	Static or total pressure (According to EC)
SR	Specific relationship	[RPM]	Speed

Facts internal fan.

Model	MC	EC	VSD	SR	ηe [%]	N	[kW]	[m3/h]	[mmH ₂ O]	[RPM]
HTTI-45-4T	A	S	NO	1.00	33.4%	41.8	0.475	4228	13.80	1392
HTTI-50-4T	B	T	NO	1.00	53.4%	60.6	0.733	9635	14.91	1395
HTTI-56-4T	B	T	NO	1.00	64.4%	70.8	0.982	12951	17.91	1427
HTTI-63-4T	C	S	NO	1.00	45.3%	51.1	1.179	10593	18.50	1412
HTTI-63-6T	C	S	NO	1.00	32.7%	41.1	0.474	6417	8.88	921
HTTI-71-4T	C	S	NO	1.00	50.1%	55.3	1.508	13256	20.95	1442
HTTI-71-6T	C	S	NO	1.00	35.7%	43.0	0.710	8036	11.60	913
HTTI-80-4T	C	S	NO	1.00	54.0%	57.1	3.246	19442	33.11	1449
HTTI-80-6T	C	S	NO	1.00	46.7%	52.1	1.380	15312	15.45	946
HTTI-90-4T	C	S	NO	1.00	56.2%	58.5	4.306	24635	36.06	1444
HTTI-90-6T	C	S	NO	1.00	50.9%	55.7	1.777	18106	18.37	957
HTTI-100-4T IE3	C	S	NO	1.00	48.4%	49.1	7.832	36164	38.48	1467
HTTI-100-6T	C	S	NO	1.00	47.3%	51.1	2.461	23849	17.92	959

Best efficiency point data of the internal fan

Dimensions in mm

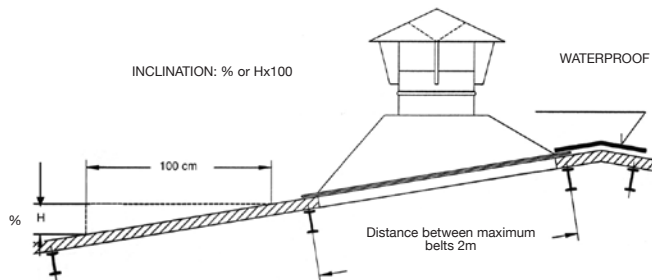

Model	A	B	C	D	ØF	G	H	ØI
HTTI-45-4T	780	130	200	250	850	730	520	470
HTTI-50-4T	800	150	200	250	950	780	570	520
HTTI-50-6T	800	150	200	250	950	780	570	520
HTTI-56-4T	800	150	200	250	1050	830	620	570
HTTI-56-6T	800	150	200	250	1050	830	620	570
HTTI-63-4T	850	180	200	250	1125	910	700	650
HTTI-63-6T	850	180	200	250	1125	910	700	650
HTTI-71-4T	900	200	230	300	1250	990	780	730
HTTI-71-6T	900	200	230	300	1250	990	780	730
HTTI-80-4T	1100	250	310	330	1400	1080	870	820
HTTI-80-6T	1100	250	310	330	1400	1080	870	820
HTTI-90-4T	1150	300	310	330	1500	1080	970	920
HTTI-90-6T	1150	300	310	330	1500	1080	970	920
HTTI-100-4T	1200	350	310	330	1600	1280	1070	1020
HTTI-100-6T	1200	350	310	330	1600	1280	1070	1020

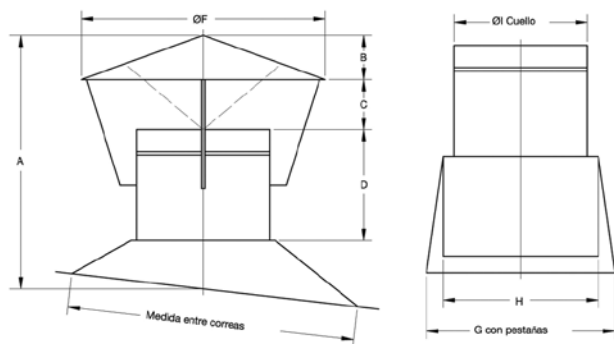

Characteristic Curves

Q = Airflow in m³/h, m³/s and cfm.

Pe = Static pressure in mmH₂O, Pa and inwg.

4T=1500 r/min

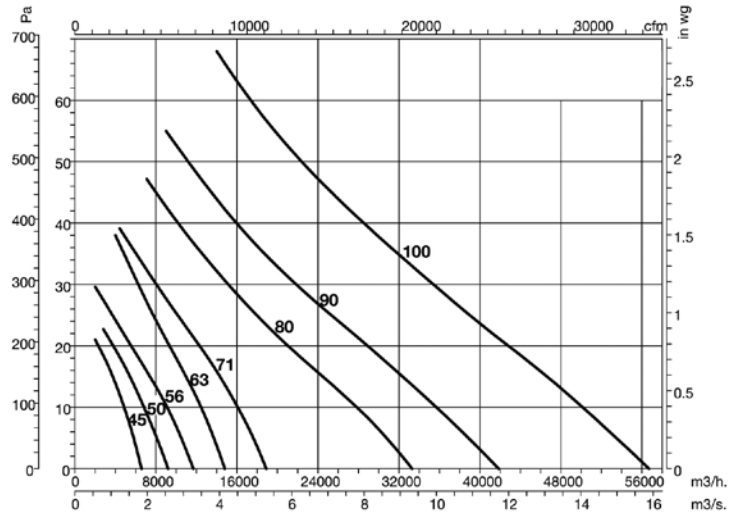

6T=1000 r/min

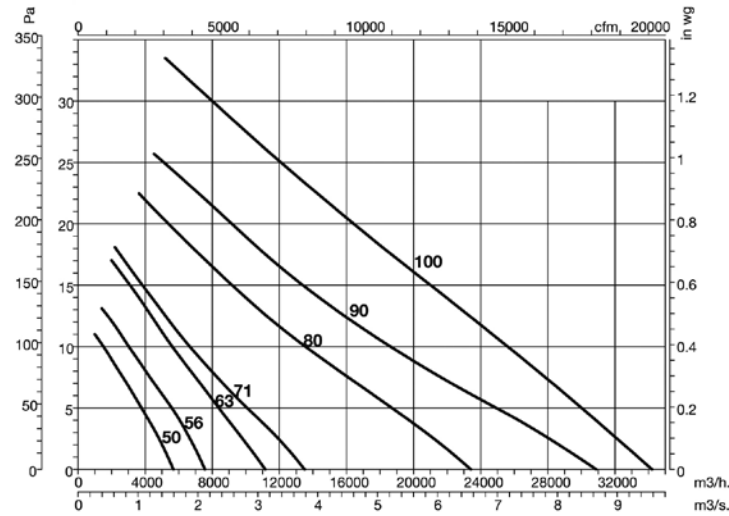

Accessories

See accessories section.



CHT CVT

400°C/2h centrifugal roof fans with horizontal or vertical air outlet

CHT: 400°C/2h centrifugal roof fans with horizontal air outlet, hood in aluminium

CVT: 400°C/2h centrifugal roof fans with vertical air outlet, hood in aluminium

Fan:

- Galvanised sheet steel base plate.
- Impeller with backward-curved blades made from galvanised sheet steel
- Bird guard
- Aluminium rain deflector hood
- Approval according to Standard EN12101-3:2002/AC:2006, with certification No. 0370-CPR-0897

Motor:

- IE2 efficiency motors for capacities equal to or over 0.75kW and below 7.5kW, except single-phase, 2 speed and 8 pole motors.
- Class F motors, with ball bearings and IP55 protection, except single-phase versions, IP54 protection, one- or two-speed depending on the model
- Single-phase 230V.-50Hz., and three-phase 230/400V.-50Hz.
- Max. air temperature to transport: -25°C + 120°C

Finish:

- Anticorrosive galvanized sheet steel and aluminium

On request:

- Special windings for different voltages.
- ATEX certification, Category 3.

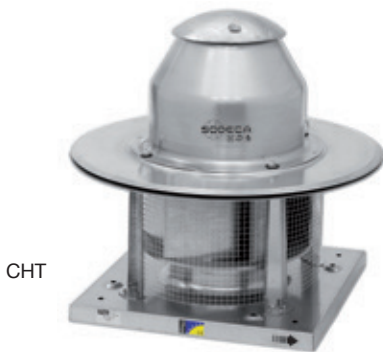

CHT



CVT



Brackets that aid mounting on the roof



Order code

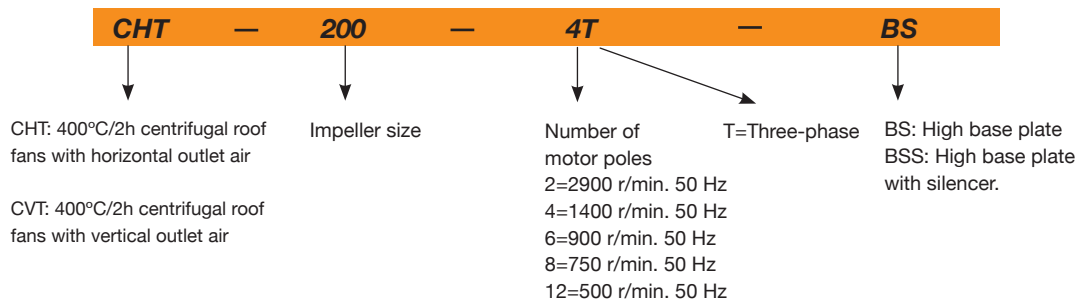

Technical characteristics

Model	Speed (r/min)	Maximum admissible current (A)		Installed capacity (kW)	Maximum airflow (m³/h)	Sound level dB(A)		Approx. weight (Kg)
		230V	400V			Inlet	Outlet	
CHT CVT 200-4T	1350	1.66	0.96	0.25	1450	37	43	25
CHT CVT 200-4M	1380	0.65		0.25	1450	37	43	25
CHT CVT 225-4T	1350	1.66	0.96	0.25	2100	41	47	25
CHT CVT 225-4M	1380	0.95		0.25	2100	41	47	25
CHT CVT 225-6T	900	1.51	0.87	0.25	1400	30	36	26
CHT CVT 225-6M	890	0.50		0.25	1400	30	36	26
CHT CVT 250-4T	1350	1.66	0.96	0.25	3100	45	50	34
CHT CVT 250-4M	1380	1.35		0.25	3100	45	50	34
CHT CVT 250-6T	900	1.51	0.87	0.25	2000	33	40	35
CHT CVT 250-6M	890	0.65		0.25	2000	33	40	35
CHT CVT 315-4T	1380	2.92	1.69	0.55	4950	48	54	39
CHT CVT 315-4/8T	1450/720		1.70 / 0.80	0.55 / 0.19	4950 / 2475	48 / 33	54 / 39	40

Technical characteristics

Model	Speed (r/min)	Maximum admissible current (A)		Installed capacity (kW)	Maximum airflow (m³/h)	Sound level dB(A)		Approx. weight (Kg)
		230V	400V			Inlet	Outlet	
CHT CVT 315-4M	1380	3.30		0.55	4950	48	54	39
CHT CVT 315-6T	900	2.24	1.30	0.37	3200	37	43	39
CHT CVT 315-6M	910	0.95		0.37	3200	37	43	39
CHT CVT 400-4T	1410	3.10	1.79	0.75	7000	55	61	57
CHT CVT 400-4/8T	1430 / 710		2.00 / 0.90	0.75 / 0.20	7000 / 3500	55 / 40	61 / 46	58
CHT CVT 400-4M	1380	4.40		0.75	7000	55	61	57
CHT CVT 400-6T	900	2.24	1.30	0.37	4500	44	50	56
CHT CVT 400-6M	910	1.80		0.37	4500	44	50	56
CHT CVT 450-4T	1430	5.96	3.44	1.50	10200	59	64	66
CHT CVT 450-4/8T	1420 / 700		3.50 / 1.50	1.50 / 0.37	10200 / 5100	59 / 43	64 / 49	66
CHT CVT 450-6T	900	2.24	1.30	0.37	6900	47	54	59
CHT CVT 450-6/12T	930 / 450		1.60 / 0.65	0.55 / 0.09	6900 / 3450	47 / 32	54 / 39	63
CHT CVT 450-6M	910	2.00		0.37	6900	47	54	59
CHT CVT 500-6T	945	4.88	2.82	1.10	12000	51	57	103
CHT CVT 500-6/12T	950 / 470		3.00 / 1.15	1.10 / 0.18	12000 / 6000	51 / 36	57 / 42	110
CHT CVT 500-8T	695	3.53	2.04	0.55	8900	44	50	103
CHT CVT 560-6T	955	9.30	5.30	2.20	17300	54	61	126
CHT CVT 560-6/12T	940 / 470		5.60 / 2.20	2.20 / 0.37	17300 / 8650	54 / 39	61 / 46	120
CHT CVT 560-8T	705	5.63	3.25	1.10	12900	46	53	110
CHT CVT 630-6T	960	16.50	9.46	4.00	24700	58	64	166
CHT CVT 630-6/12T	970 / 480		11.00 / 4.00	4.00 / 0.65	24700 / 12350	58 / 43	64 / 49	161
CHT CVT 630-8T	705	7.10	4.10	1.50	18400	50	57	148

(1) The sound level values are measurements of pressure in dB(A) at a distance of 6 m and at 2/3 of the maximum airflow (2/3 Qmax.)



Erp. BEP (best efficiency point) characteristics

MC	Measurement category	ηe[%]	Efficiency
EC	Efficiency category	N	Degree of efficiency
S	Static	[kW]	Electrical power
T	Total	[m³/h]	Airflow
VSD	Variable-speed drive	[mmH₂O]	Static or total pressure (According to EC)
SR	Specific relationship	[RPM]	Speed

Model	MC	EC	VSD	SR	ηe [%]	N	[kW]	[m3/h]	[mmH₂O]	[RPM]
200-4T	-	-	-	-	-	-	0.099	855	17.36	1462
200-4M	-	-	-	-	-	-	0.114	888	18.71	1467
225-4T	C	S	NO	1.00	41.2%	59.9	0.169	1205	21.26	1430
225-4M	C	S	NO	1.00	42.0%	60.1	0.189	1257	23.15	1442
225-6T	-	-	-	-	-	-	0.054	826	10.00	981
225-6M	-	-	-	-	-	-	0.068	875	11.21	986
250-4T	C	S	NO	1.00	45.0%	61.1	0.292	1788	26.99	1359
250-4M	C	S	NO	1.00	43.5%	59.3	0.315	1813	27.75	1377
250-6T	-	-	-	-	-	-	0.106	1262	13.44	959
250-6M	C	S	NO	1.00	40.6%	60.1	0.138	1344	15.26	971
315-4T	C	S	NO	1.00	50.4%	63.3	0.588	2652	41.02	1381
315-4/8T	C	S	NO	1.00	50.2%	62.4	0.690	2794	45.50	1454
315-4M	C	S	NO	1.00	48.1%	60.6	0.653	2705	42.67	1408
315-6T	C	S	NO	1.00	43.4%	61.4	0.192	1689	18.09	956
315-6M	C	S	NO	1.00	45.5%	62.9	0.219	1792	20.35	963
400-4T	C	S	NO	1.00	60.8%	72.4	0.788	4472	39.34	1411
400-4/8T	C	S	NO	1.00	52.3%	63.0	0.956	4536	40.48	1432
400-4M	C	S	NO	1.00	48.3%	59.1	0.942	4343	38.48	1419
400-6T	C	S	NO	1.00	48.9%	64.6	0.319	3148	18.20	926
400-6M	C	S	NO	1.00	51.3%	66.4	0.363	3338	20.46	933
450-4T	C	S	NO	1.01	60.6%	67.9	2.018	7176	62.55	1440
450-4/8T	C	S	NO	1.01	53.3%	60.1	2.254	7133	61.81	1431
450-6T	C	S	NO	1.00	54.1%	66.5	0.667	4779	27.75	959
450-6/12T	C	S	NO	1.00	49.0%	60.7	0.767	4844	28.51	948
450-6M	C	S	NO	1.00	47.6%	59.1	0.796	4854	28.63	925
500-6T	C	S	NO	1.00	62.9%	72.5	1.238	6832	41.88	923
500-6/12T	C	S	NO	1.00	61.7%	70.8	1.372	7023	44.25	957
500-8T	C	S	NO	1.00	47.1%	59.4	0.674	5027	23.21	695
560-6T	C	S	NO	1.01	59.4%	66.1	2.282	9457	52.64	956
560-6/12T	C	S	NO	1.01	53.4%	59.9	2.422	9313	51.05	942
560-8T	C	S	NO	1.00	53.0%	63.2	1.060	7052	29.27	713
630-6T	C	S	NO	1.01	63.0%	67.3	3.879	14310	62.66	968
630-6/12T	C	S	NO	1.01	58.3%	62.2	4.250	14377	63.25	973
630-8T	C	S	NO	1.00	58.0%	66.3	1.629	10429	33.28	706

Best efficiency point data of the motor-impeller unit

Acoustic features

The specified values are determined according to free field measurements of pressure and sound levels in dB(A) at a distance of 6 m.

Sound power Lw(A) spectrum in dB(A) via frequency band in Hz.

Values taken at the inlet with 2/3 of the maximum airflow (2/3Qmax).

Model	63	125	250	500	1000	2000	4000	8000
200	35	41	52	55	56	52	50	44
225-4	42	51	56	56	60	59	52	46
225-6	31	40	45	45	49	48	41	35
250-4	46	55	60	60	64	63	56	50
250-6	34	43	48	48	52	51	44	38
315-4	50	56	62	62	65	68	59	53
315-6	39	45	51	51	54	57	48	42
315-8	35	41	47	47	50	53	44	38
400-4	57	63	69	69	72	75	66	60
400-6	46	52	58	58	61	64	55	49
400-8	42	48	54	54	57	60	51	45
450-4	62	69	74	74	78	77	70	65
450-6	50	57	62	62	66	65	58	53
450-8	46	53	58	58	62	61	54	49
450-12	35	42	47	47	51	50	43	38
500-6	54	60	65	66	70	69	62	55
500-8	47	53	58	59	63	62	55	48
500-12	39	45	50	51	55	54	47	40
560-6	57	63	68	69	73	72	65	58
560-8	49	55	60	61	65	64	57	50
560-12	42	48	53	54	58	57	50	43
630-6	61	67	72	73	77	76	69	62
630-8	53	59	64	65	69	68	61	54
630-12	46	52	57	58	62	61	54	47

Values taken at outlet with 2/3 of the maximum airflow (2/3Qmax).

Model	63	125	250	500	1000	2000	4000	8000
200	39	44	58	60	61	61	56	51
225-4	41	50	60	64	67	64	57	51
225-6	30	39	49	53	56	53	46	40
250-4	44	53	63	67	70	67	60	54
250-6	34	43	53	57	60	57	50	44
315-4	49	61	69	71	72	72	64	56
315-6	38	50	58	60	61	61	53	45
315-8	34	46	54	56	57	57	49	41
400-4	56	68	76	78	79	79	71	63
400-6	45	57	65	67	68	68	60	52
400-8	41	53	61	63	64	64	56	48
450-4	60	72	80	82	83	80	73	65
450-6	50	62	70	72	73	70	63	55
450-8	45	57	65	67	68	65	58	50
450-12	35	47	55	57	58	55	48	40
500-6	50	64	72	76	75	72	66	60
500-8	43	57	65	69	68	65	59	53
500-12	35	49	57	61	60	57	51	45
560-6	54	68	76	80	79	76	70	64
560-8	46	60	68	72	71	68	62	56
560-12	39	53	61	65	64	61	55	49
630-6	57	71	79	83	72	79	73	67
630-8	50	64	72	76	72	72	66	60
630-12	42	56	64	68	67	64	58	52

To obtain the Lwa sound power spectra in dB(A) at the inlet with the maximum airflow (Qmax), add the values in the following tables to the LpA sound pressure level given on the characteristic curves:

Frequency band in Hz							
63	125	250	500	1000	2000	4000	8000
2	9	15	15	18	18	11	5

Dimensions in mm

CHT

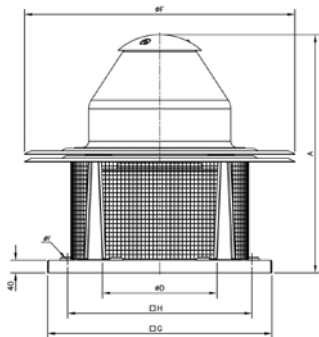

Model	A	øD*	øF	G	H	øl
CHT-200	552	250	570	450	360	12
CHT-225	570	250	570	450	360	12
CHT-250	632	355	726	560	450	12
CHT-315	682	355	726	560	450	12
CHT-400	755	500	856	710	590	12
CHT-450	770	500	856	710	590	12
CHT-500	846	630	1075	900	750	14
CHT-560	1035	710	1300	1100	900	14
CHT-630	1098	710	1300	1100	900	14

(*) Recommended nominal diameter for duct.

CVT

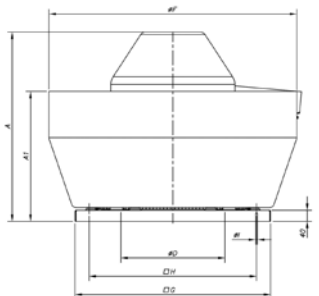

Model	A	A1	øD*	øF	G	H	øl
CVT-200	500	308	250	530	450	360	12
CVT-225	517	308	250	530	450	360	12
CVT-250	580	380	355	705	560	450	12
CVT-315	630	380	355	705	560	450	12
CVT-400	690	475	500	900	710	590	12
CVT-450	705	475	500	900	710	590	12
CVT-500	775	545	630	1100	900	750	14
CVT-560	956	676	710	1295	1100	900	14
CVT-630	1017	676	710	1295	1100	900	14

(*) Recommended nominal diameter for duct.

Accessories

See accessories section



Characteristic Curves

Q = Airflow in m³/h, m³/s and cfm.
 Pe = Static pressure in mmH₂O, Pa and inwg.
 The Lp (dB(A)) sound levels given on the curves are free field pressure measurements at 6 metres at the inlet.

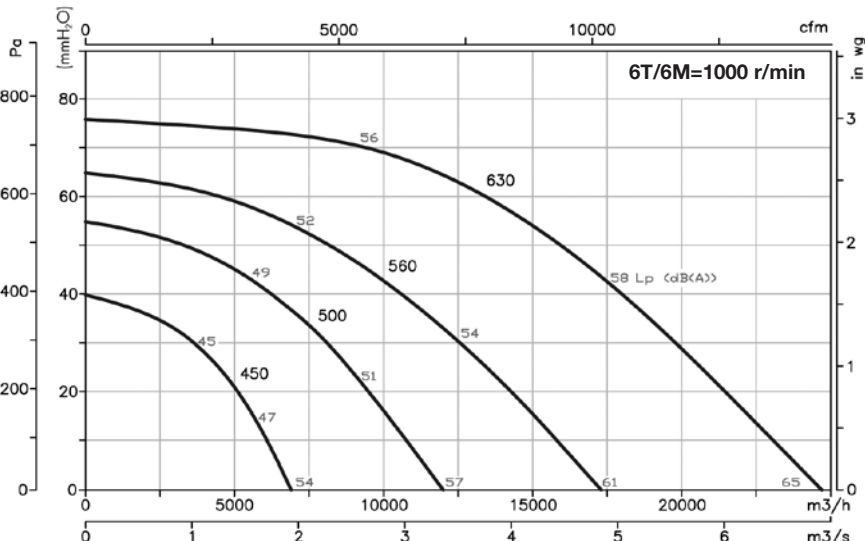
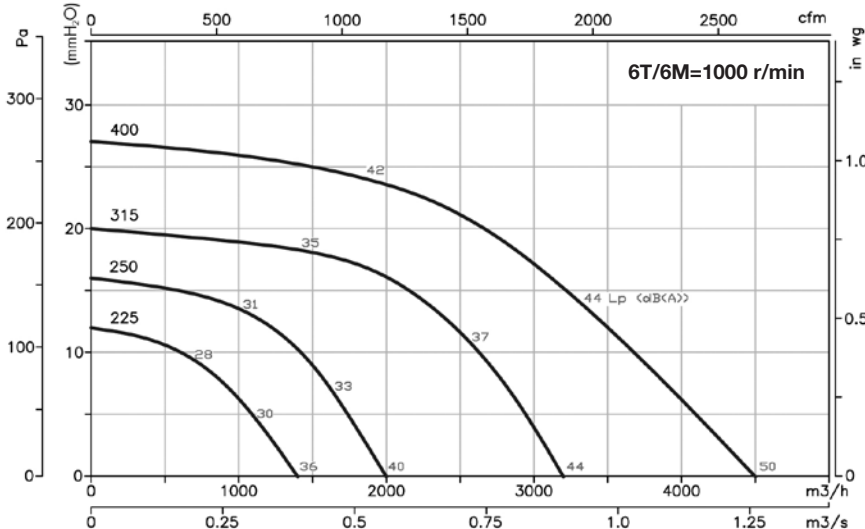
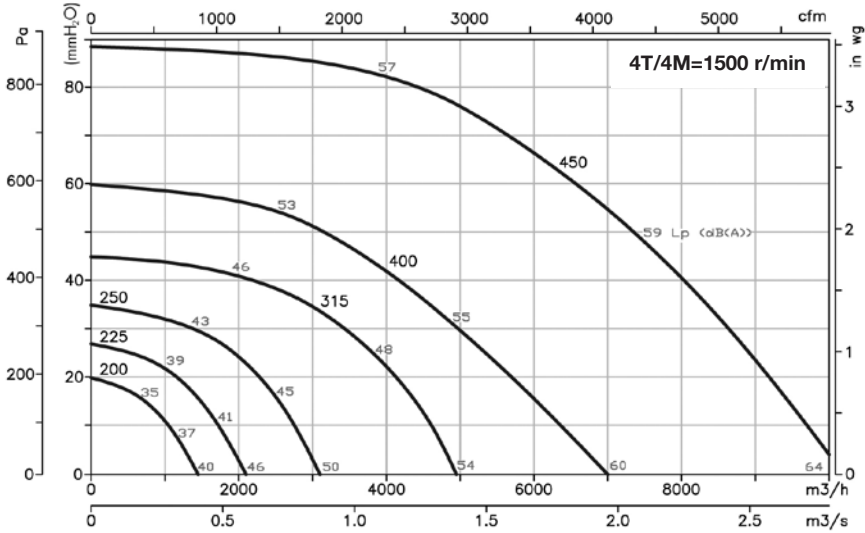

Characteristic Curves

Q = Airflow in m³/h, m³/s and cfm.

Pe= Static pressure in mmH₂O, Pa and inwg.

The Lp (dB(A)) sound levels given on the curves are free field pressure measurements at 6 metres at the inlet.

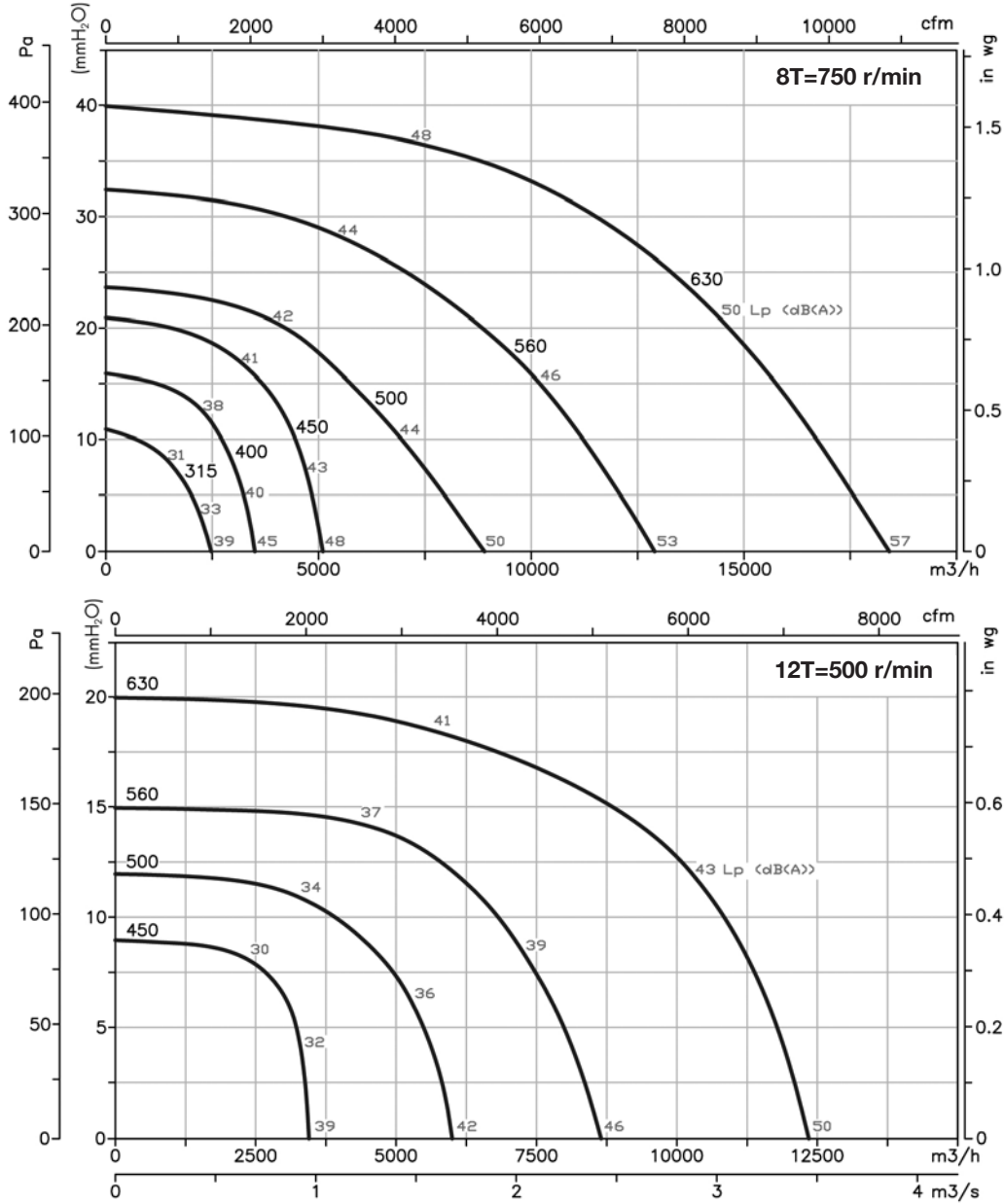

Variation of sound pressure depending on distance

The sound level may vary depending on the roof structure.

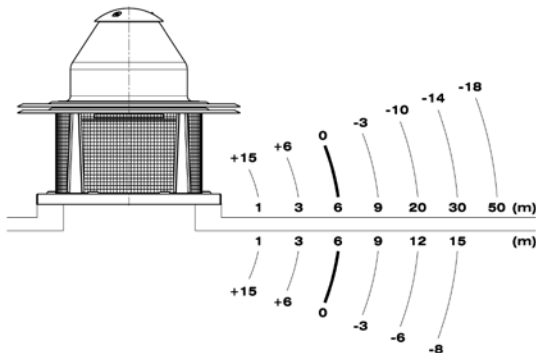

Example of use

Fans suitable for use in industrial kitchens.

For the correct application of the standard:

- Technical Building Code. Basic SI Document for fire safety. Basic HS Document for health and safety.

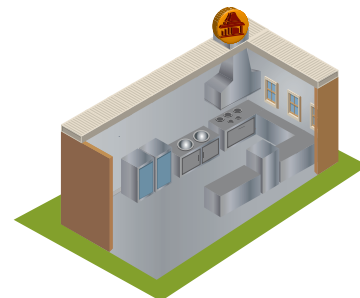

RFHD



Centrifugal roof fans with horizontal outlet and ATEX Ex d certification

Centrifugal roof fans with horizontal air outlet and hood in aluminium. ATEX certification and CEE ExII2G Ex d flame-resistant to work in explosive atmospheres.



Ex "d" marked: CE Ex II 2G Ex d
 Notified authority: L.O.M
 Identification No:
 LOM03ATEX0147

Fan:

- Base support in galvanized steel with inlets made from brass according to standard EN-14986:2007
- Impeller with backward-curved blades made from galvanized sheet steel
- Bird guard
- Aluminium rain deflector hood

Motor:

- Class F motors with ball bearings and ATEX certification, Ex d II B T4 Gb flame-resistant
- Three-phase 230/400 V-50 Hz. (up to 4kW) and 400/690 V-50 Hz. (power over 4kW)

- Max. air temperature to transport: -20 °C+ 80 °C

Finish:

- Anticorrosive galvanized sheet steel and aluminium

On request:

- Built-in motors with PTC.
- Special windings for different voltages and frequencies
- ATEX construction for different categories
- Ex d flame-resistant single-phase motors

Order code

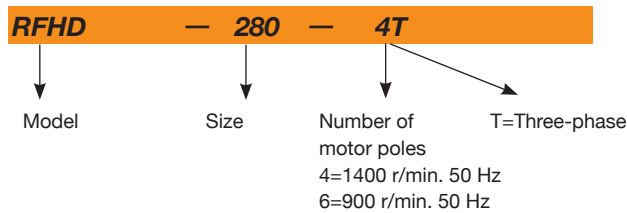

Technical characteristics

Model	Speed (r/min)	Maximum current admissible (A)			Installed capacity (kW)	Maximum airflow (m³/h)	Sound pressure level dB(A)		Approx. weight (Kg)
		230V	400V	690V			Inlet	Outlet	
RFHD-280-4T	1370	2.08	1.20		0.25	1450	37	43	25
RFHD-315-4T	1370	2.08	1.20		0.25	2100	41	47	25
RFHD-315-6T	910	2.42	1.40		0.25	1400	30	36	25
RFHD-355-4T	1370	2.08	1.20		0.25	3100	45	50	32
RFHD-355-6T	910	2.42	1.40		0.25	2000	33	40	33
RFHD-400-4T	1410	2.94	1.70		0.55	4950	48	54	35
RFHD-400-6T	935	2.77	1.60		0.37	3200	37	43	35
RFHD-450-4T	1410	3.81	2.20		0.75	7000	55	61	52
RFHD-450-6T	935	2.77	1.60		0.37	4500	44	50	51
RFHD-500-4T	1400	6.93	4.00		1.50	10200	59	64	60
RFHD-500-6T	935	2.77	1.60		0.37	6900	47	54	53
RFHD-630-6T	910	5.89	3.40		1.10	12000	51	57	95
RFHD-710-6T	940	9.35	5.40		2.20	17300	54	61	118
RFHD-800-6T	950		14.00	8.10	5.50	24700	58	64	160

(1) The sound level values are measurements of pressure in dB(A) at a distance of 6 m and at 2/3 of the maximum airflow (2/3 Qmax.)

Acoustic features

The specified values are determined according to free field measurements of pressure and sound levels in dB(A) at a distance of 6 m.

Sound power Lw(A) spectrum in dB(A) via frequency band in Hz.

Values taken at the inlet with 2/3 of the maximum airflow (2/3Qmax).

Model	63	125	250	500	1000	2000	4000	8000
280-4	35	41	52	55	56	52	50	44
315-4	42	51	56	56	60	59	52	46
315-6	31	40	45	45	49	48	41	35
355-4	46	55	60	60	64	63	56	50
355-6	34	43	48	48	52	51	44	38
400-4	50	56	62	62	65	68	59	53
400-6	39	45	51	51	54	57	48	42
450-4	57	63	69	69	72	75	66	60
450-6	46	52	58	58	61	64	55	49
500-4	62	69	74	74	78	77	70	65
500-6	50	57	62	62	66	65	58	53
630-6	54	60	65	66	70	69	62	55
710-6	57	63	68	69	73	72	65	58
800-6	61	67	72	73	77	76	69	62

Values taken at outlet with 2/3 of the maximum airflow (2/3Qmax).

Model	63	125	250	500	1000	2000	4000	8000
280-4	39	44	58	60	61	61	56	51
315-4	41	50	60	64	67	64	57	51
315-6	30	39	49	53	56	53	46	40
355-4	44	53	63	67	70	67	60	54
355-6	34	43	53	57	60	57	50	44
400-4	49	61	69	71	72	72	64	56
400-6	38	50	58	60	61	61	53	45
450-4	56	68	76	78	79	79	71	63
450-6	45	57	65	67	68	68	60	52
500-4	60	72	80	82	83	80	73	65
500-6	50	62	70	72	73	70	63	55
630-6	50	64	72	76	75	72	66	60
710-6	54	68	76	80	79	76	70	64
800-6	57	71	79	83	72	79	73	67

To obtain the Lwa sound power spectra in dB(A) at the inlet with the maximum airflow (Qmax), add the values in the following tables to the LpA sound pressure level given on the characteristic curves:

Frequency band in Hz							
63	125	250	500	1000	2000	4000	8000
2	9	15	15	18	18	11	5

Dimensions in mm

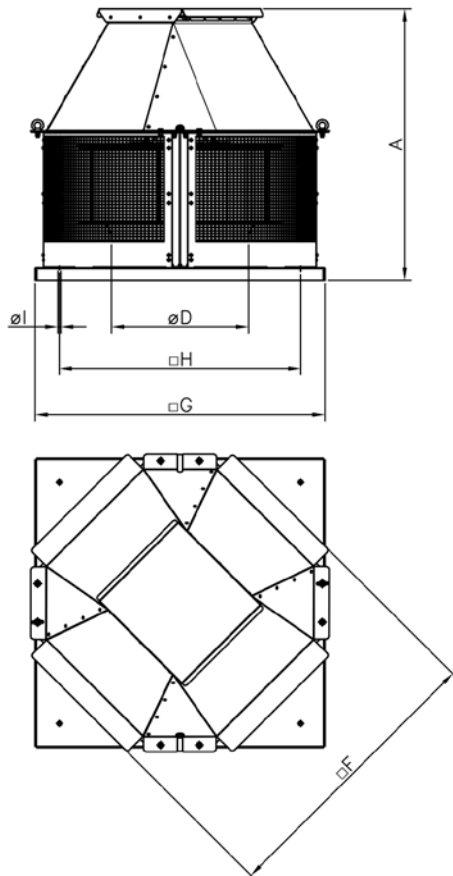

Model	A	ØD*	F	G	H	ØI
RFHD-280	515	250	460	450	360	12
RFHD-315	540	250	460	450	360	12
RFHD-355	610	355	565	560	450	12
RFHD-400	665	355	565	560	450	12
RFHD-450	720	500	735	710	590	12
RFHD-500	755	500	735	710	590	12
RFHD-630	845	630	890	900	750	14
RFHD-710	995	710	1110	1100	900	14
RFHD-800	1065	710	1110	1100	900	14

(*) Recommended nominal diameter for duct.

Characteristic Curves

Q = Airflow in m³/h, m³/s and cfm.

Pe= Static pressure in mmH₂O, Pa and inwg.

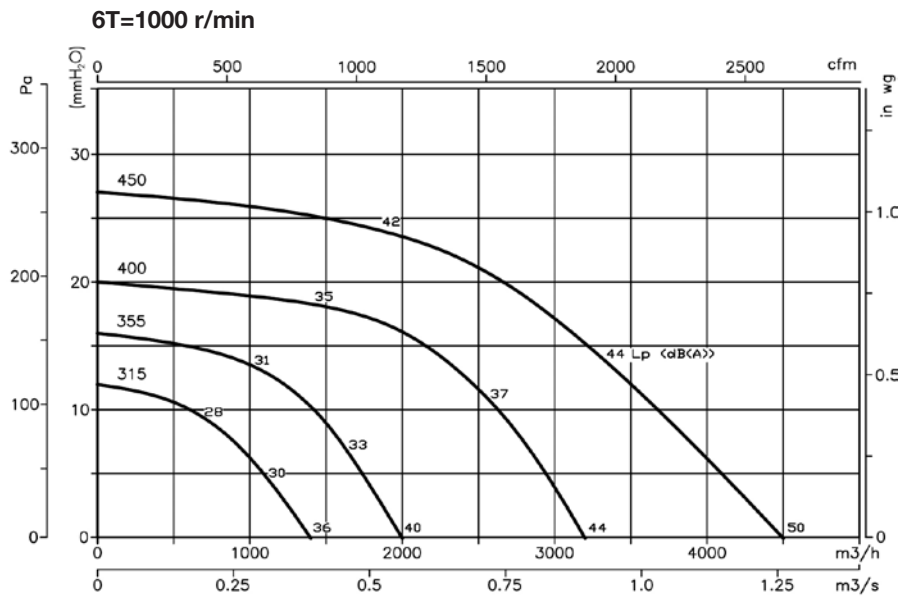
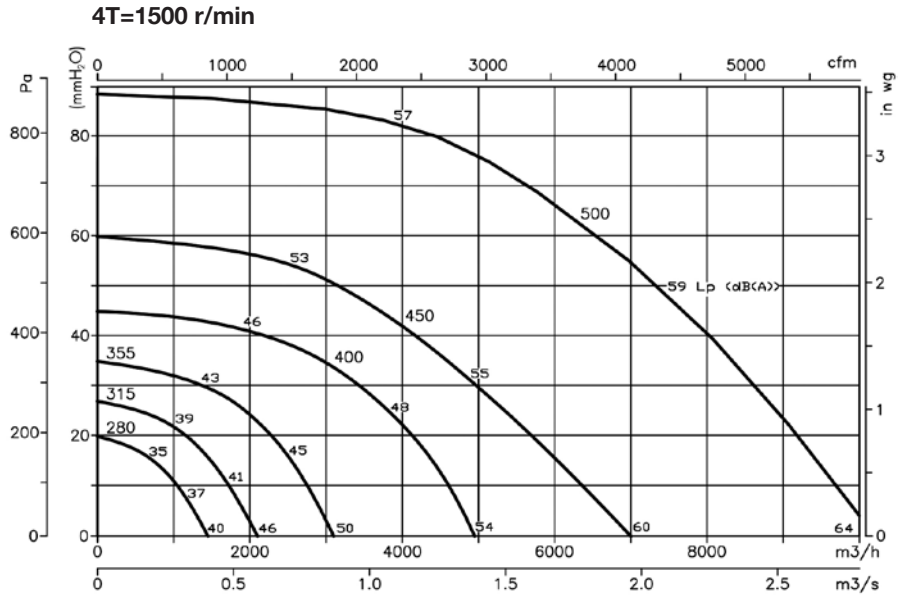

Characteristic Curves

Q = Airflow in m³/h, m³/s and cfm.

Pe= Static pressure in mmH₂O, Pa and inwg.

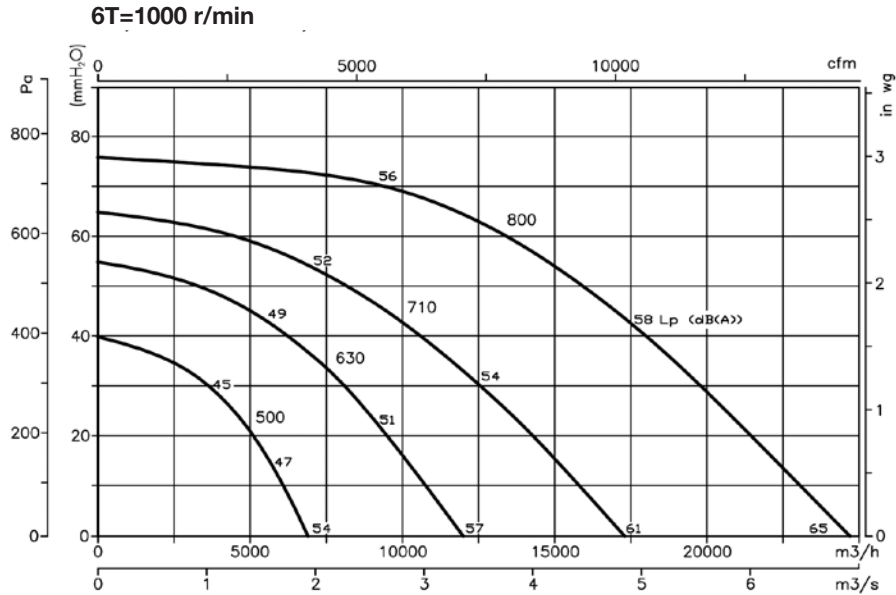

Accessories

See accessories section

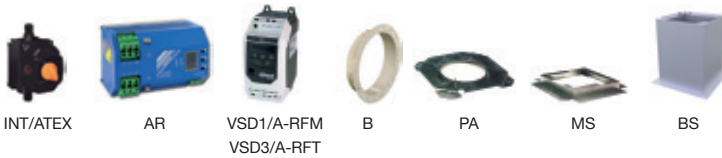

Mounting accessories RFHD

RFHD Fan	Base plate	Support frame	Adaptation plate
280/315	BS-443	MS-443	PA-440/250
355/400	BS-553	MS-553	PA-550
450/500	BS-701	MS-701	PA-700/500
630	BS-891	MS-891	PA-890/630
710/800	BS-1086	MS-1086	PA-1085

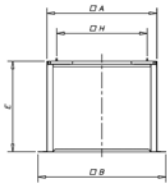

BS. High base plate

	A	B	H	E
BS-443	449	616	360	800
BS-553	554	724	450	800
BS-701	706	876	590	900
BS-891	896	1076	750	900
BS-1086	1092	1272	900	900

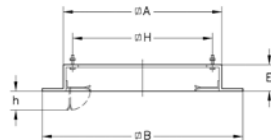

MS. Support frame to facilitate assembly

	A	B	E	H	h
MS-443	443	615	60	360	70
MS-553	553	725	60	450	70
MS-701	701	875	60	590	90
MS-891	891	1065	60	750	90
MS-1086	1086	1260	60	900	90

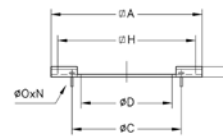

PA. Adaptation plate to mount accessories on roof fans

	A	ØC	ØD	E	H	ØE	N
PA-440/250	440	280	249	20	360	M.6	4x90°
PA-550	550	395	354	20	450	M.6	8x45°
PA-700/500	700	560	499	20	590	M.10	12x30°
PA-890/630	890	690	629	20	750	M.10	12x30°
PA-1085	1088	770	704.5	20	900	M.10	16x22°30'

CHRE



Centrifugal roof fans with low noise level

Centrifugal roof fans with low noise level and external rotor motor.



Fan:

- Sheet steel base plate.
- Impeller with backward-curved blades made from sheet steel
- Bird guard
- Sheet steel rain deflector hood with anticorrosive protection

Motor:

- Class F external rotor motors, IP54 protection
- Single-phase 230V.-50Hz., and three-phase 230/400V.-50Hz.
- Max. air temperature to transport: -25°C + 50°C

Finish:

- Anticorrosive finish in polyester resin polymerised at 190°C, after alkaline degreasing with phosphate-free nanotechnology treatment.

Order code

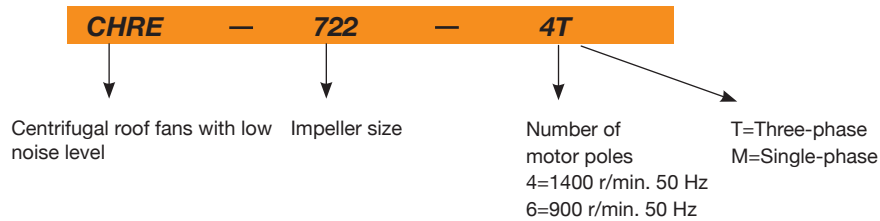

Technical characteristics

Model	Speed (r/min)	Maximum admissible current (A)		Max. electric power (kW)	Maximum airflow (m³/h)	Sound pressure level ¹ at 2/3 of Qmax dB(A)		Approx. weight (Kg)
		230V	400V			Inlet	Outlet	
CHRE-722-4T	1360	0.31	0.18	0.06	650	31	37	7.6
CHRE-722-4M	1360	0.25		0.06	650	31	37	7.6
CHRE-825-4T	1360	0.52	0.30	0.08	950	32	38	9.1
CHRE-825-4M	1360	0.34		0.08	950	32	38	9.1
CHRE-1131-4T	1330	0.78	0.45	0.17	2000	39	45	14.1
CHRE-1131-4M	1330	0.70		0.16	2000	39	45	14.1
CHRE-1131-6T	910	0.43	0.25	0.07	1280	28	34	13.6
CHRE-1131-6M	910	0.35		0.08	1280	28	34	13.6
CHRE-1135-4T	1280	0.95	0.55	0.20	2500	43	48	19.1
CHRE-1135-4M	1280	0.85		0.20	2500	43	48	19.1
CHRE-1135-6T	880	0.52	0.30	0.11	1800	31	38	18.1
CHRE-1135-6M	880	0.50		0.12	1800	31	38	18.1
CHRE-1240-4T	1330	1.49	0.86	0.48	4000	46	52	24.8
CHRE-1240-4M	1330	2.10		0.48	4000	46	52	26.3
CHRE-1240-6M	860	0.70		0.16	2400	35	41	22.8
CHRE-1445-4T	1345	2.17	1.25	0.67	5400	53	59	36.0
CHRE-1445-4M	1345	2.80		0.64	5400	53	59	38.0
CHRE-1445-6T	920	1.13	0.65	0.28	3700	42	48	34.5
CHRE-1445-6M	920	1.10		0.26	3700	42	48	36.0
CHRE-1650-4T	1380	3.29	1.90	1.25	7600	57	62	40.5
CHRE-1650-4M	1380	5.80		1.33	7600	57	62	48.5
CHRE-1650-6T	900	1.40	0.81	0.66	5200	45	52	38.0
CHRE-1650-6M	900	3.00		0.69	5200	45	52	40.0

(1) The sound level values are measurements of pressure in dB(A) at a distance of 6 m and at 2/3 of the maximum airflow (2/3 Qmax.)



Erp. BEP (best efficiency point) characteristics

MC	Measurement category	ηe [%]	Efficiency
EC	Efficiency category	N	Degree of efficiency
S	Static	[kW]	Electrical power
T	Total	[m³/h]	Airflow
VSD	Variable-speed drive	[mmH₂O]	Static or total pressure (According to EC)
SR	Specific relationship	[RPM]	Speed

Model	MC	EC	VSD	SR	ηe [%]	N	[kW]	[m3/h]	[mmH ₂ O]	[RPM]
CHRE-722-4T	-	-	-	-	-	-	0.053	345	11.55	1368
CHRE-722-4M	-	-	-	-	-	-	0.057	348	11.32	1361
CHRE-825-4T	-	-	-	-	-	-	0.073	561	14.78	1367
CHRE-825-4M	-	-	-	-	-	-	0.078	567	14.49	1360
CHRE-1131-4T	C	S	NO	1.00	39.6%	58.5	0.160	1072	21.71	1352
CHRE-1131-4M	C	S	NO	1.00	41.7%	60.8	0.151	1083	21.33	1341
CHRE-1131-6T	-	-	-	-	-	-	0.074	712	9.40	920
CHRE-1131-6M	-	-	-	-	-	-	0.080	719	9.21	911
CHRE-1135-4T	C	S	NO	1.00	43.0%	60.9	0.196	1182	26.12	1286
CHRE-1135-4M	C	S	NO	1.00	42.4%	60.2	0.200	1191	26.04	1280
CHRE-1135-6T	-	-	-	-	-	-	0.108	909	13.19	885
CHRE-1135-6M	-	-	-	-	-	-	0.116	918	12.93	880
CHRE-1240-4T	C	S	NO	1.00	46.4%	60.4	0.461	1955	40.11	1347
CHRE-1240-4M	C	S	NO	1.00	45.3%	59.2	0.467	2081	37.27	1332
CHRE-1240-6M	-	-	-	-	-	-	0.120	1127	13.64	889
CHRE-1445-4T	C	S	NO	1.00	50.7%	63.0	0.668	3441	36.10	1355
CHRE-1445-4M	C	S	NO	1.00	50.5%	63.1	0.626	3364	34.49	1360
CHRE-1445-6T	C	S	NO	1.00	42.8%	59.9	0.237	2303	16.16	932
CHRE-1650-4T	C	S	NO	1.00	51.2%	60.7	1.246	4905	47.71	1380
CHRE-1650-4M	C	S	NO	1.00	50.9%	60.2	1.307	4976	49.10	1387
CHRE-1650-6T	C	S	NO	1.00	44.9%	59.4	0.414	3252	20.97	937
CHRE-1650-6M	C	S	NO	1.00	44.0%	58.5	0.416	3234	20.75	934

Best efficiency point data of the motor-impeller unit

Acoustic features

Values taken at inlet with 2/3 of the maximum airflow (2/3Q_{max}).

Model	Sound power L _w (A) spectrum in dB(A) via frequency band in Hz.							
	63	125	250	500	1000	2000	4000	8000
722	29	35	46	49	50	46	44	38
825	30	36	47	50	51	47	45	39
1131-4	40	49	54	54	58	57	50	44
1131-6	29	38	43	43	47	46	39	33
1135-4	44	53	58	58	62	61	54	48
1135-6	32	41	46	46	50	49	42	36
1240-4	48	54	60	60	63	66	57	51
1240-6	37	43	49	49	52	55	46	40
1445-4	55	61	67	67	70	73	64	58
1445-6	44	50	56	56	59	62	53	47
1650-4	60	67	72	72	76	75	68	63
1650-6	48	55	60	60	64	63	56	51

Values taken at outlet with 2/3 of the maximum airflow (2/3Q_{max}).

Model	Sound power L _w (A) spectrum in dB(A) via frequency band in Hz.							
	63	125	250	500	1000	2000	4000	8000
722	33	38	52	54	55	55	50	45
825	34	39	53	55	56	56	51	46
1131-4	39	48	58	62	65	62	55	49
1131-6	28	37	47	51	54	51	44	38
1135-4	42	51	61	65	68	65	58	52
1135-6	32	41	51	55	58	55	48	42
1240-4	47	59	67	69	70	70	62	54
1240-6	36	48	56	58	59	59	51	43
1445-4	54	66	74	76	77	77	69	61
1445-6	43	55	63	65	66	66	58	50
1650-4	58	70	78	80	81	78	71	63
1650-6	48	60	68	70	71	68	61	53

To obtain the L_{wa} sound power spectra in dB(A) at the inlet with the maximum airflow (Q_{max}), add the values in the following tables to the L_{pA} sound pressure level given on the characteristic curves:

Frequency band in Hz							
63	125	250	500	1000	2000	4000	8000
2	9	15	15	18	18	11	5

Dimensions in mm

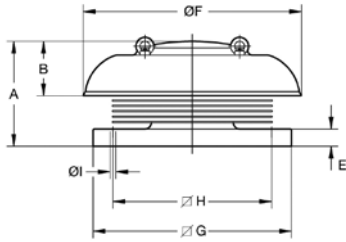

Model	A	B	E	ØF	ØG	ØH	ØI
CHRE-722	194	110	30	440	355	295	12
CHRE-825	212	110	35	440	400	320	12
CHRE-1131	308	176	40	620	450	360	12
CHRE-1135	325	176	40	620	560	450	12
CHRE-1240	351	176	40	620	560	450	12
CHRE-1445	393	228	40	770	710	590	12
CHRE-1650	426	228	40	770	710	590	12

Variation of sound pressure depending on distance

The sound level may vary depending on the roof structure.

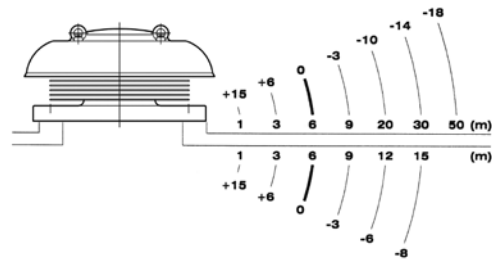

Characteristic Curves

Q = Airflow in m³/h, m³/s and cfm.
inwa.

Pe = Static pressure in mmH₂O, Pa and in wg.

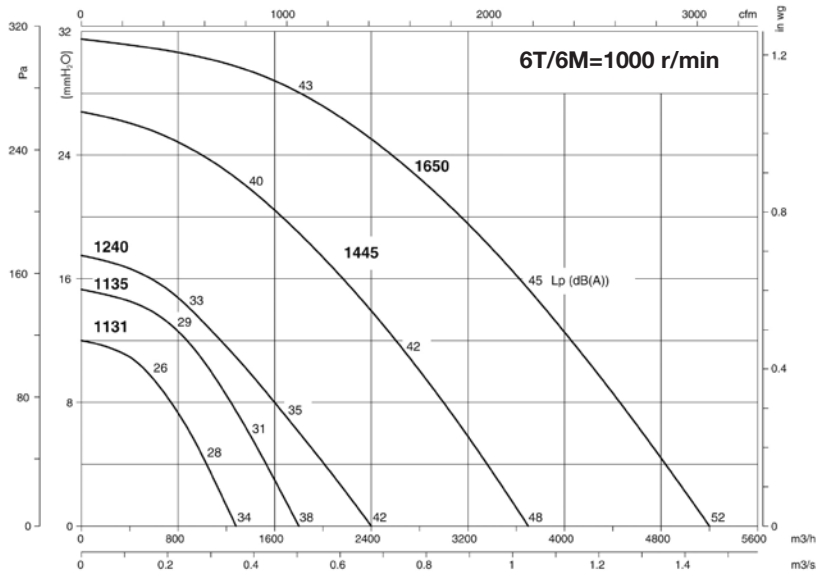
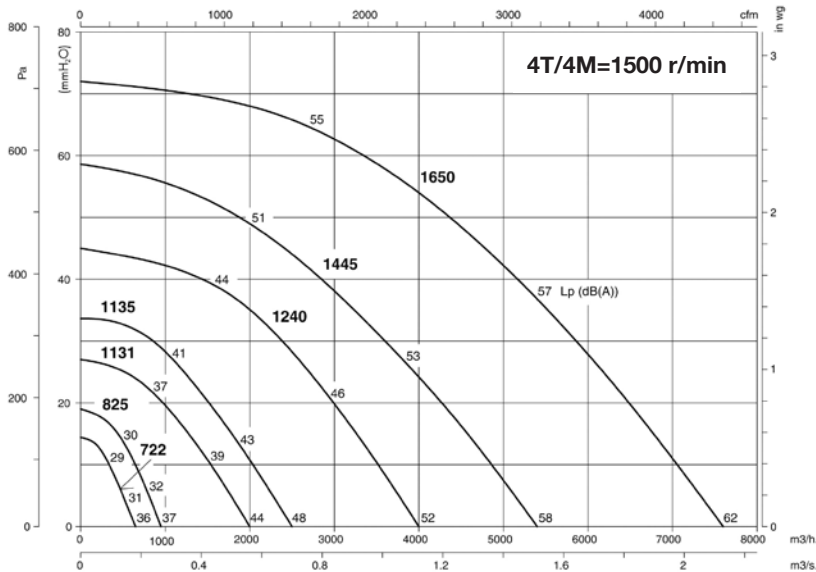

Accessories

See accessories section



CTD

Centrifugal roof fans for houses ventilation

Low noise centrifugal roof fans for houses ventilation in accordance with the Spanish Technical Building Code

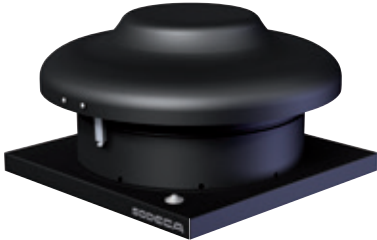

Fan:

- Sheet steel base plate.
- Impeller with backward-curved blades made from sheet steel
- Sheet steel rain deflector hood with anticorrosive protection
- Adjustable by variation of voltage
- Safety switch on request

Motor:

- Class F external rotor motors, IP54 protection
- Single-phase 230V.-50Hz.
- Max. air temperature to transport: -40°C + 70°C

Finish:

- Anticorrosive finish in polyester resin polymerised at 190°C, after alkaline degreasing with phosphate-free nanotechnology treatment.



B version

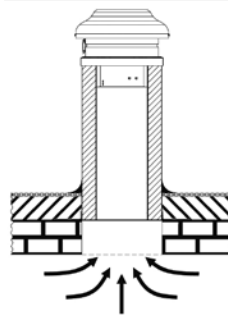

C version

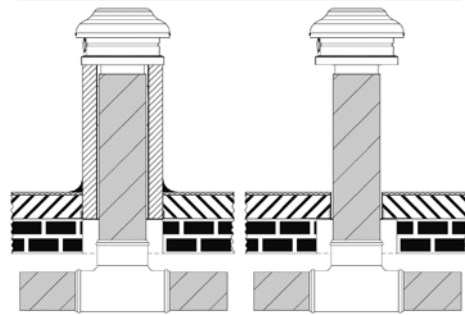

Order code

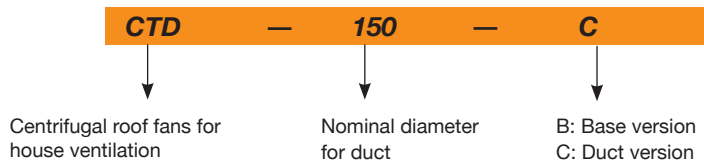

Technical characteristics

Model	Speed (r/min)	Maximum admissible current (A) 230V	Max. electric power (W)	Maximum airflow (m³/h)	Sound pressure level ¹ at 2/3 of Qmax dB(A)		Approx. weight (Kg)
					Inlet	Outlet	
CTD 150	2442	0.28	65	409	43	37	4.4
CTD 160	2442	0.28	65	409	43	37	4.4
CTD 200	2534	0.42	97	711	46	39	6.8
CTD 250	2542	0.68	155	926	46	41	7.6
CTD 315	2442	0.90	208	1024	48	42	8

(1) The sound level values are measurements of pressure in dB(A) at a distance of 6 m and at 2/3 of the maximum airflow (2/3 Qmax).

Acoustic features

The specified values are determined according to free field measurements of pressure and sound levels in dB(A) at a distance of 6 m.

Sound power Lw(A) spectrum in dB(A) via frequency band in Hz.

Values taken at the inlet with 2/3 of the maximum airflow (2/3Qmax).

Model	63	125	250	500	1000	2000	4000	8000
CTD 150	38	44	54	59	60	61	57	41
CTD 160	38	44	54	59	60	61	57	41
CTD 200	39	50	57	63	64	62	58	54
CTD 250	40	52	56	63	64	62	56	51
CTD 315	44	57	59	64	65	63	62	57

Values taken at outlet with 2/3 of the maximum airflow (2/3Qmax).

Model	63	125	250	500	1000	2000	4000	8000
CTD 150	28	37	51	54	58	53	47	32
CTD 160	28	37	51	54	58	53	47	32
CTD 200	31	44	53	57	58	54	50	40
CTD 250	32	44	53	58	61	59	52	43
CTD 315	34	50	55	58	61	59	52	45

Dimensions in mm

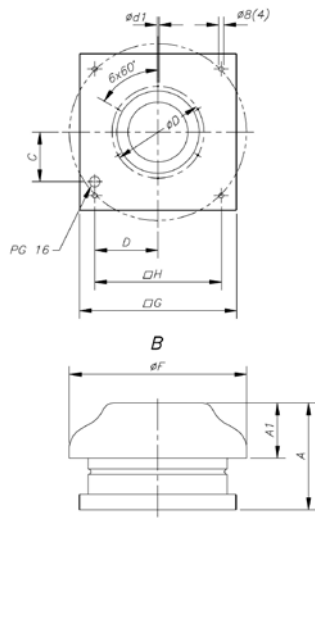

Modelo	øF	A	A1	∅G	øD	ød1	C	D	∅H	øO
CTD-150/B	344	207.3	107	305	177	6.1	96.5	123.5	245	-
CTD-160/B	344	207.3	107	305	177	6.1	96.5	123.5	245	-
CTD-200/B	450	214.35	109	405	230	7.1	138	168	330	-
CTD-250/B	450	245.55	109	405	230	7.1	138	168	330	-
CTD-315/B	450	245.55	109	405	230	7.1	138	168	330	-
CTD-150/C	344	207.3	107	305	177	6.1	96.5	123.5	245	147
CTD-160/C	344	207.3	107	305	177	6.1	96.5	123.5	245	157
CTD-200/C	450	214.35	109	405	230	7.1	138	168	330	197
CTD-250/C	450	245.55	109	405	230	7.1	138	168	330	247
CTD-315/C	450	245.55	109	405	230	7.1	138	168	330	312

Characteristic Curves

Q = Airflow in m³/h, m³/s and cfm.

Pe = Static pressure in mmH₂O, Pa and inwg.

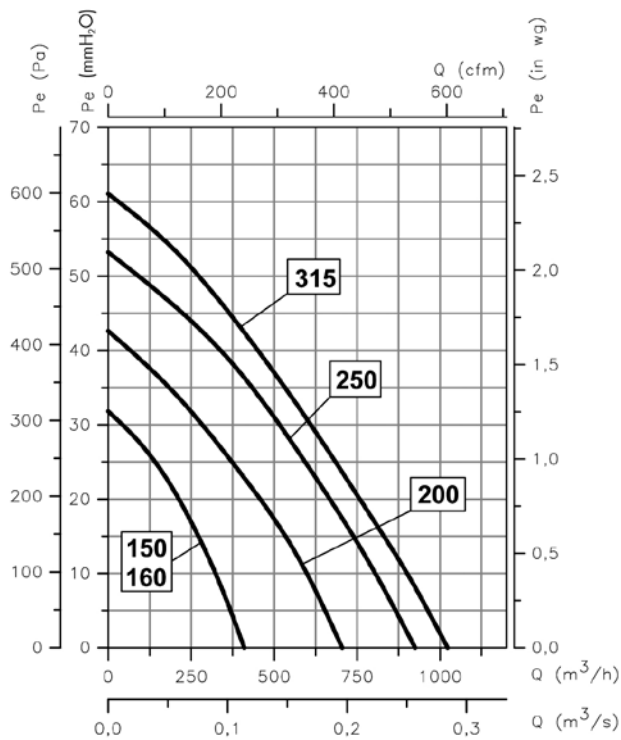

On request

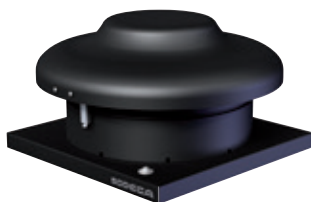

INT
Safety switch

CA-ROOF

Centrifugal roof fans for extraction from chimneys in houses



In-line centrifugal extractor with built-in cap for air extraction or ventilation, for use in individual dwellings or community housing.

- Designed for continuous working, in any position
- Optionally supplied with base or for direct connection to flue, depending on model

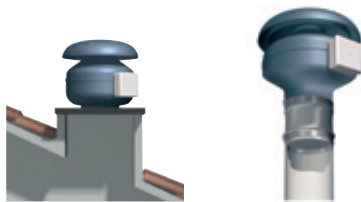

B version

C version

Construction:

- Galvanised sheet base plate
- Impeller with backward-curved blades
- Galvanised sheet rain deflector hood
- Treated with rust-inhibitor paint

Motor:

- Motor with Long Life ball bearings, IPX4 protection
- Single-phase 230V.50 Hz.
- Fan working temperature: -20°C +50°C
- Automatically reset thermal protector

Order code

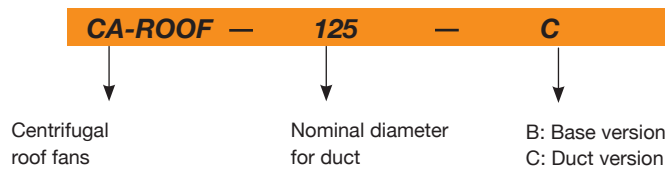

Technical characteristics

Model	Speed (r/min)	Maximum admissible current (A) 220-240V	Max. electric power (W)	Maximum airflow (m³/h)	Irradiated* Sound Level dB(A)	Weight (Kg)
CA/ROOF 125	2300	0.34	75	350	54	5
CA/ROOF 150	2370	0.34	80	450	56.5	7
CA/ROOF 160	2650	0.68	150	750	64	8.8
CA/ROOF 200	2700	0.69	160	850	63	8
CA/ROOF 250	2430	0.80	180	1180	61.5	9.9
CA/ROOF 315	2480	1.10	250	1600	64.5	11

*Irradiated sound pressure level are free field measurements at 3 metres

Dimensions in mm

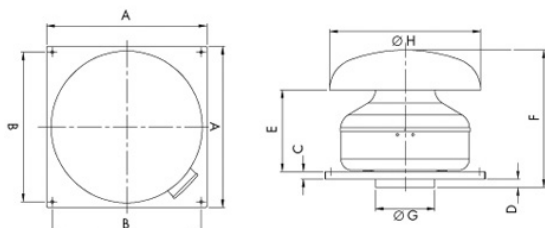

Model	A	B	C	D	E	F	Ø G	Ø H
CA/ROOF 125	334	280	20	2	193	290	122	300
CA/ROOF 150	424	370	20	17	198	340	147	400
CA/ROOF 160	424	370	20	22	214	361	157	400
CA/ROOF 200	424	370	20	17	203	345	197	534
CA/ROOF 250	489	435	20	27	193	376	247	534
CA/ROOF 315	489	435	20	21	226	403	312	534

Accessories

See accessories section



Characteristic Curves

Q = Airflow in m³/h, m³/s and cfm.

Pe = Static pressure in mmH₂O, Pa and inwg.

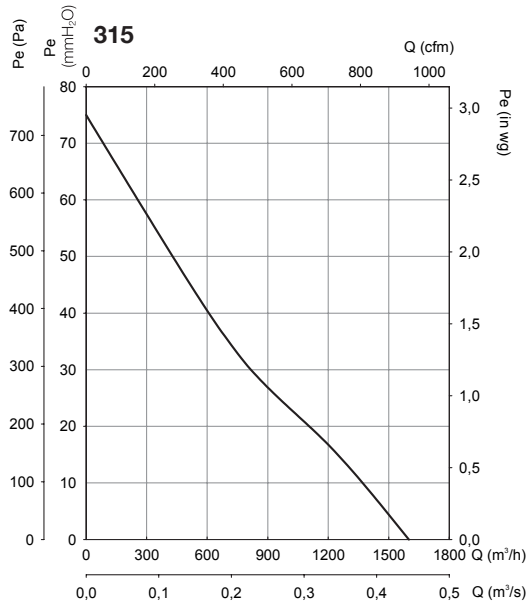
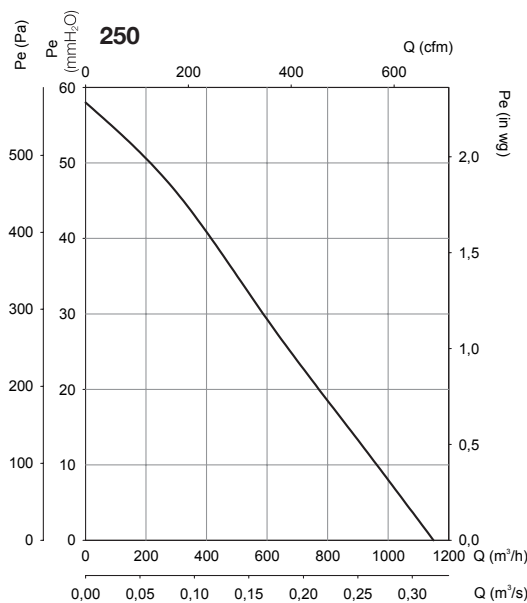
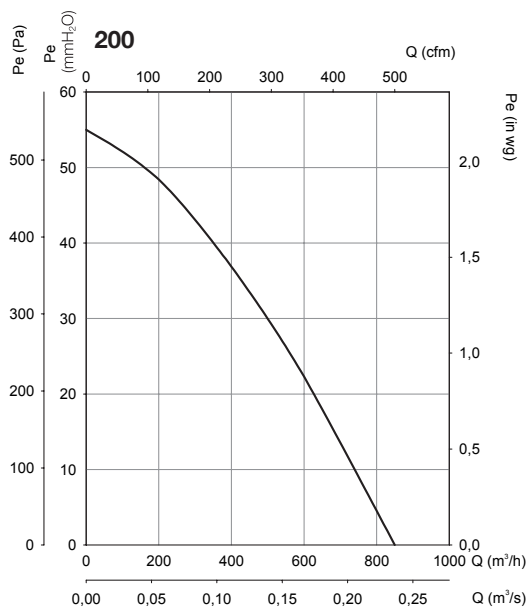
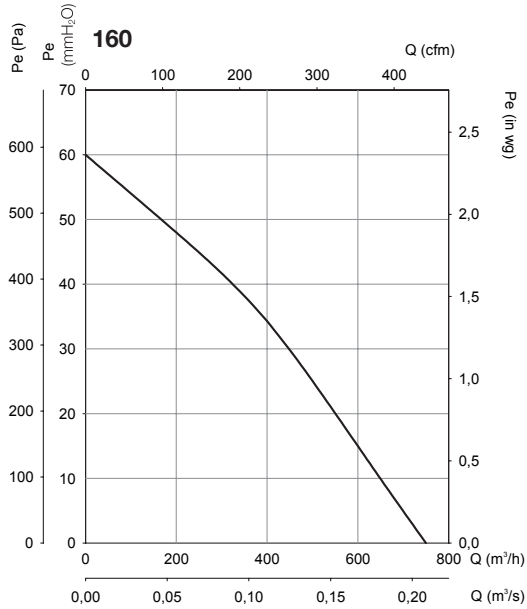
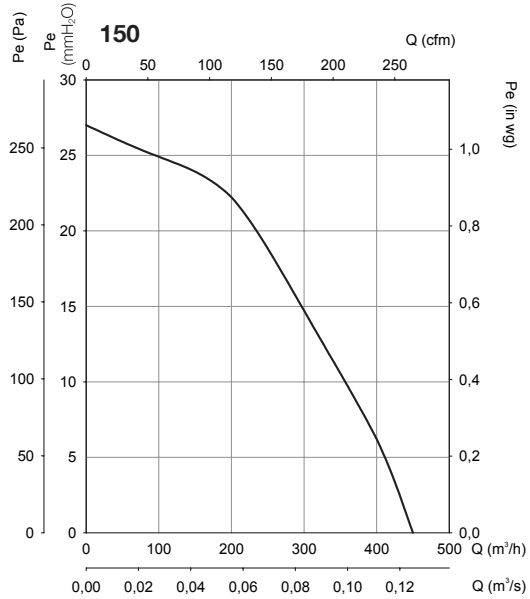
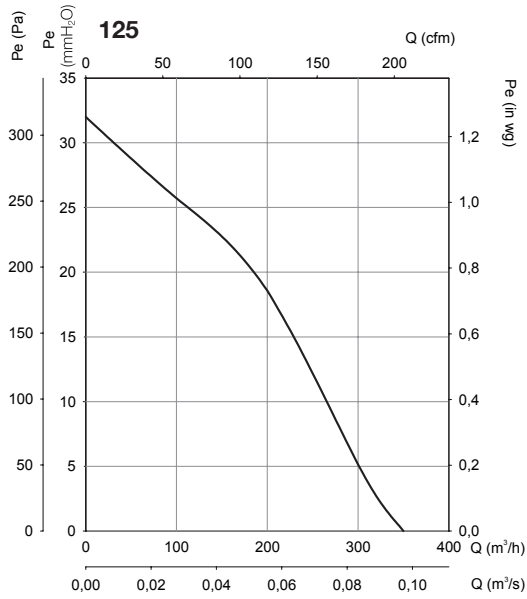



TIRACAMINO

Fans to extract smoke from chimneys and barbecues



- Designed especially to extract smoke up to 200°C from chimneys and barbecues
- Equipped with an electronic regulator so as to regulate the speed and the flow of the extractor according to the real need for smoke extraction
- Designed for continuous operation at 200°C

Construction:

- Manufactured in sheet steel with polyester resin to stand up to atmospheric agents
- Bird guard
- Supplied voltage 230V 50 Hz

Motor:

- BASIC: works with separate switch or regulator

Technical characteristics

Model	Speed (r/min)	Maximum admissible current (A) 220-240V	Absorbed power (W)	Maximum airflow (m ³ /h)	Sound pressure level dB(A)	Approx. Weight (Kg)
TIRACAMINO	1400	0.50	120	750	52	14.3

(*) The sound level values are measurements of pressure in dB(A) at a distance of 3 m with maximum airflow

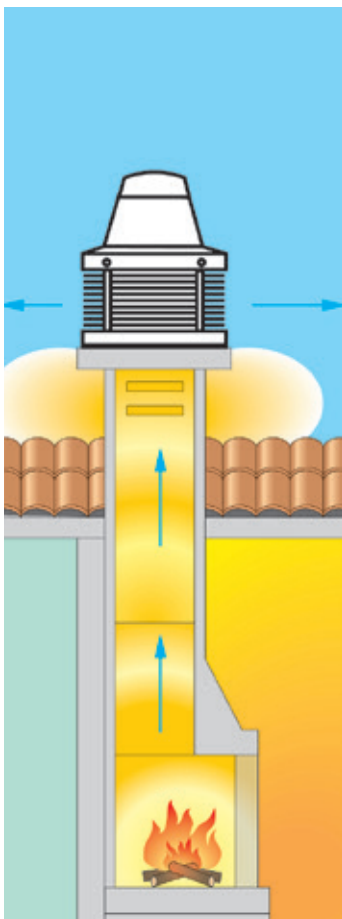

Dimensions in mm

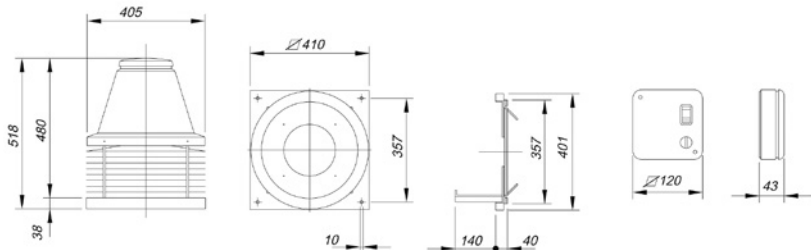

Characteristic Curves

Q = Airflow in m³/h, m³/s and cfm.

Pe = Static pressure in mmH₂O, Pa and inwg.

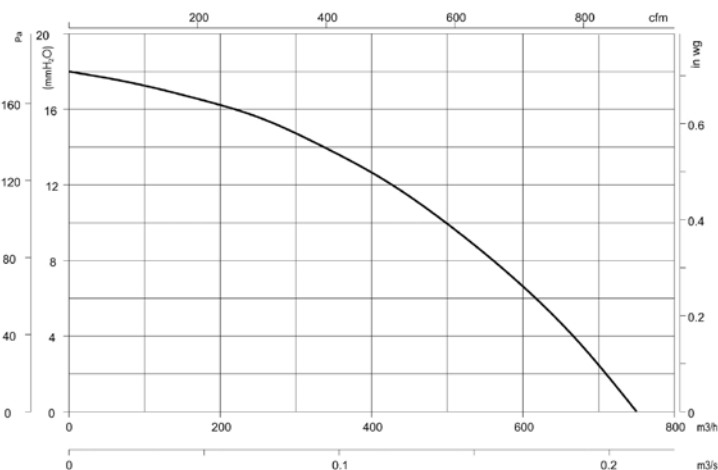

RCH



SI-VENT Accessories



Fan and chimney top for hybrid extraction in community housing

- Designed especially for the extraction of air in houses or community housing, through chimneys or shunts. It makes it possible to maintain an attractive and uniform design throughout the house
- The Venturi version, only suitable for natural extraction, without an extractor
- The lightness of the aluminium means that installation on the roof is rapid and simple

Construction:

- Manufactured in black pre-lacquered aluminium which is not altered by atmospheric agents.
- Perfectly designed slats so as to obtain a high-performance Venturi effect
- Supplied voltage 230V 50 Hz

- **TEMPERATURA:** Designed for the extraction of air in homes and barbecues with a maximum temperature of 150°C.

On request:

- Measurements to fit any chimney

Versions:

- **BASIC:** It works with a switch or with a SI-VENT wind monitor
- **VENTURI:** Natural operation without an extractor using the Venturi effect



SYSTEM OF HYBRID VENTILATION (H.V)

This system is based on natural air extraction when the wind conditions outside are favourable; when they are unfavourable the extractor with an electric motor comes into operation so as to guarantee the minimum necessary extraction.

The electrical extractor is started up by wind sensors, which are especially designed for this application

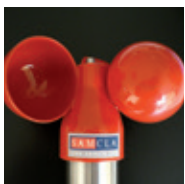

WIND CONTROLLER

SI-VENT, Wind sensor

The SI-VENT electronic wind controller is a highly robust and reliable device, made up of a sensor, a controller and the power supply.

The sensor is capable of measuring winds of up to 100 k.p.h. and the controller starts up the electrical extractor when the wind speed is below the programmed minimum wind value for five minutes.

RCH-400x800VM

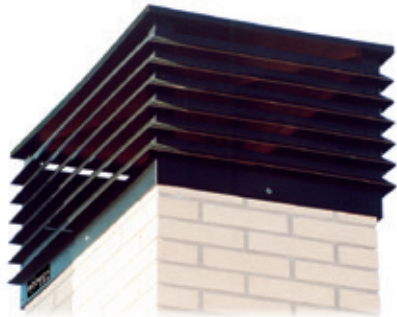

Fan and chimney top for hybrid extraction in community housing

An assembly specially designed for controlled mechanical extraction through chimneys or condominium shunt chimneys. The system makes it possible to maintain a constant pressure in the installation, with the speed of the extractor self-regulated, obtaining the flow necessary at each moment according to the different needs of the installation, achieving a significant energy saving

- It makes it possible to maintain an attractive and uniform design throughout the house.
- The lightness of the aluminium means that installation on the roof is rapid and simple
- On request, sized to fit any chimney

Construction:

- Manufactured in black pre-lacquered aluminium which is not altered by atmospheric agents
- Perfectly designed slats so as to obtain a high-performance Venturi effect
- Impeller unit with backward-curved blades with external rotor motor
- Adjustable differential pressure transmitter from 0 ...250 Pa, including screen for digital display and connection accessories
- Speed regulator by means of a frequency converter VSD1/A-RFM-0,5

Motor:

- Motor with Long Life ball bearings, IP54 protection
- Converter supply, single-phase 230V. 50 Hz., converter output voltage to motor, three-phase 230V. 50Hz
- Fan working temperature: -20°C +50°C

Technical characteristics

Model	Speed (r/min)	Maximum admissible current (A)		Installed capacity (kW)	Max. electric power (kW)	Maximum airflow (m³/h)	Sound pressure (1) level at 2/3 of Qmax dB(A)		Approx. weight (Kg)
		230V	400V				Inlet	Outlet	
RCH-400x400B	1360	0.34	-	-	0.08	950	32	35	9
RCH-400x400T	1380	0.65	-	0.25	-	1450	37	40	25
RCH-400x600B	910	0.35	-	-	0.08	1280	28	31	14
RCH-400x800B	880	0.50	-	-	0.12	1800	31	35	18
RCH-400x800VM	1280	-	0.55	-	0.20	2500	43	48	19

(1) The sound level values are measurements of pressure in dB(A) at a distance of 6 m and at 2/3 of the maximum airflow (2/3 Qmax.)

Dimensions in mm

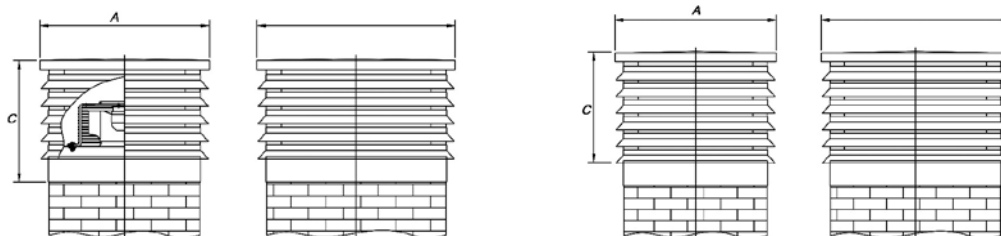

Model	A	B	C
RCH-400x400B	400	400	420
RCH-400x400T	400	400	600
RCH-400x600B	400	600	420
RCH-400x800B	400	800	420
RCH-400x800VM	400	800	420

Model	A	B	C	Useful area
RCH-400x400V	400	400	600	0.134 m²
RCH-400x600V	400	600	600	0.191 m²
RCH-400x800V	400	800	600	0.248 m²

Characteristic Curves

Q = Airflow in m³/h, m³/s and cfm.

Pe = Static pressure in mmH₂O, Pa and inwg.

RCH

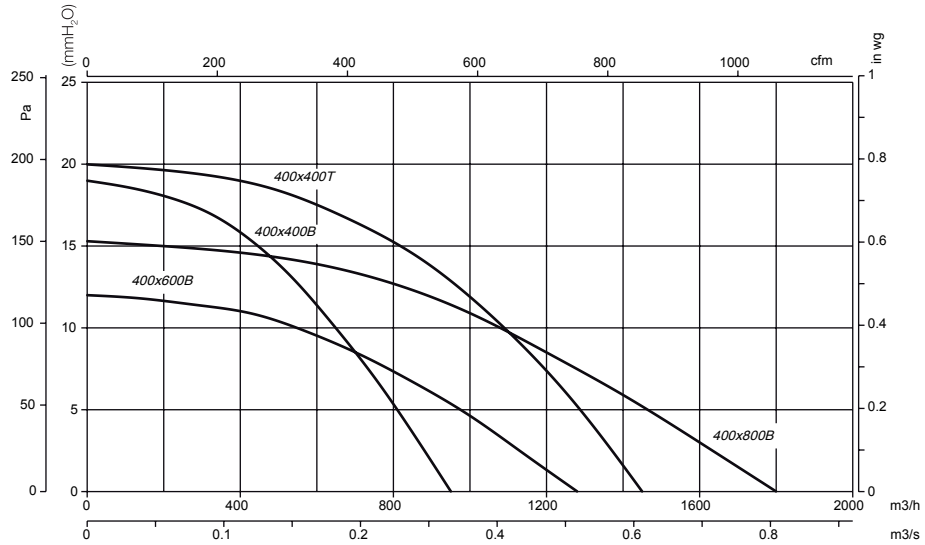

RCH-400x800VM

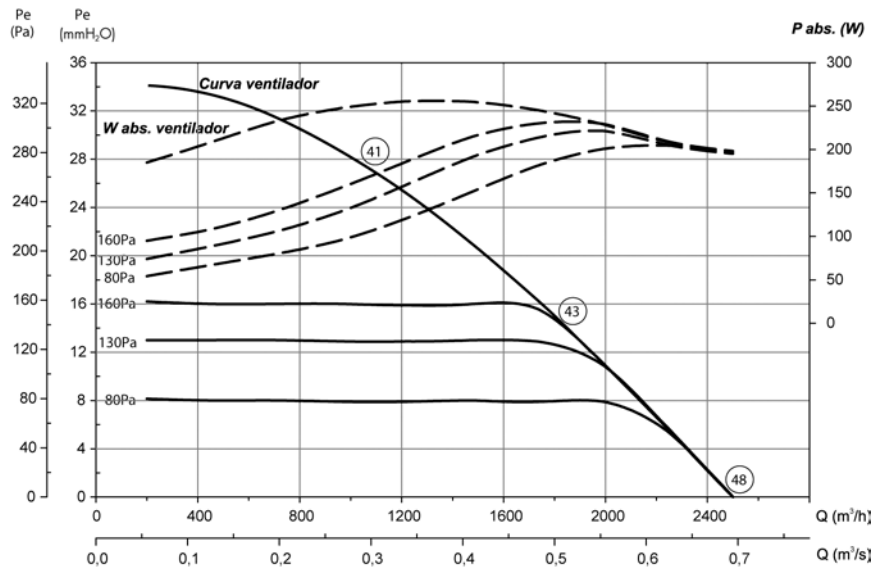





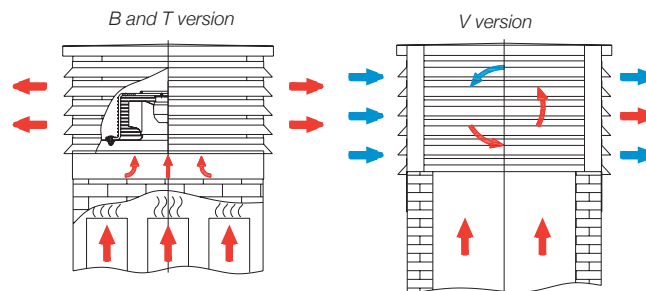





















The LpA sound levels given on the curves are free field pressure measurements at 6 meters at the inlet

Examples of operation



Accessories

<p>INT</p>  <p>On/Off safety switches compliant with the UNE-EN 60204-1 Standard.</p> <p>151</p>	<p>RM</p>  <p>Electronic speed controllers</p> <p>151</p>	<p>C2V</p>  <p>Switch for two-speed motors</p> <p>151</p>	<p>AR</p>  <p>Smooth starters for three-phase motors.</p> <p>151</p>	<p>VSD3/A-RFT VSD1/A-RFM</p>  <p>Electronic variable speed drives</p> <p>152</p>
<p>KME</p>  <p>External control kit for On/Off and velocity control for VSD1/A-RFM and VSD3/A-RFT frequency converters</p> <p>153</p>	<p>GMP</p>  <p>Electrical starter panel and protection of fans with three-phase motor, with On/Off buttons</p> <p>153</p>	<p>GMM</p>  <p>Electrical starter panel and protection from overload and short-circuits of fans with three-phase motor, with rotary controls</p> <p>153</p>	<p>ELECTRICAL PANELS</p>  <p>Electrical panels</p> <p>153</p>	<p>PL</p>  <p>Backdraught louvres</p> <p>154</p>
<p>P</p>  <p>Aluminium backdraught louvres</p> <p>154</p>	<p>P-400</p>  <p>Backdraught louvres certified for 400°C/2h</p> <p>154</p>	<p>R</p>  <p>Protection guard for axial fan inlet.</p> <p>155</p>	<p>RI</p>  <p>Protection guard for axial fans outlet.</p> <p>155</p>	<p>RT</p>  <p>Protection guard for inlet or outlet of long-cased axial fans.</p> <p>155</p>
<p>PV</p>  <p>Inlet hood with guard</p> <p>155</p>	<p>BTUB</p>  <p>Coupling flange for axial fans</p> <p>155</p>	<p>B</p>  <p>Coupling flange for centrifugal fans</p> <p>156</p>	<p>BAC</p>  <p>Double, elastic coupling flange for axial fans</p> <p>156</p>	<p>PS</p>  <p>Support stands for long-cased fans.</p> <p>156</p>
<p>MS</p>  <p>Support frame to facilitate mounting on-site</p> <p>157</p>	<p>BS BSS</p>  <p>High base plate and high base plate with silencer</p> <p>157</p>	<p>PA</p>  <p>Adaptation plate for mounting accessories on roof fans.</p> <p>157</p>	<p>PT PT/H</p>  <p>Automatic-closing shutters to work in vertical or horizontal position</p> <p>157</p>	<p>PT/H - 400</p>  <p>Automatic-closing shutters to work in vertical and horizontal positions certified for 400°C/2h</p> <p>157</p>
<p>OP</p>  <p>Backdraught shutters for roof fans</p> <p>158</p>	<p>REG</p>  <p>Manual adjustment hatch</p> <p>158</p>	<p>S</p>  <p>Silencers to fit to inlet or outlet</p> <p>158</p>	<p>MOTORS</p> <p>Three-phase asynchronous motors</p>  <p>159</p>	<p>INTELLIGENT SENSORS</p>  <p>160</p>



INT

Stop-start safety switches in accordance with Standard UNE-EN 60204-1.

Features:

- Switch to be placed beside the fan, so that mains current can be cut without handling the fan
- IP65 protection
- For three-phase or two-speed fans, use 6-pole switch
- For single-phase fans, use a 3-pole switch

Model	Intensity (A)	(kW)	Cables input (mm)	Model	Current (A)	(kW)	Cables input (mm)
INT-CA 10/3CA	20	5.5	19	INT-CA 10/6CA	20	5.5	19
INT-KG 10/3CA	20	5.5	23	INT-KG 10/6CA	20	5.5	23
INT-KG 20/3CA	25	7.5	29	INT-KG 20/6CA	25	7.5	29
INT-KG 32/3CA	32	11	29	INT-KG 32/6CA	32	11	29
INT-KG 41/3CA	40	15	37.5	INT-KG 41/6CA	40	15	37.5
INT-KG 64/3CA	63	22	37.5	INT-KG 64/6CA	63	22	37.5
INT-KG 80/3CA	80	30	37.5	INT-KG 80/6CA	80	30	37.5
INT-KG 100/3CA	100	37	37.5	INT-KG 100/6CA	100	37	37.5



RM

Electronic speed controllers

Features:

- Electronic speed controllers especially designed for fans with single-phase motors, in accordance with standard EN-60335
- Models RM-1, RM-2 and RM-3, IP-54 protection, Models RM-00, RM-01 and RM-02, IP-44 protection
- In accordance with Electromagnetic Compatibility Directives 92/31/EEC and 93/68/EEC and in accordance with Low Voltage Directive 73/23/EEC
- On/off switch

- Minimum speed adjustment
- With EMC filters in accordance with standard EN-55014

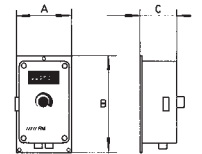

Model	Input voltage	Protection	Maximum current (A)	Model	A	B	C
RM-00	230 V-50/60 Hz	IP-44	0.5	RM-00	81	81	66
RM-01	230 V-50/60 Hz	IP-44	1	RM-01	81	81	66
RM-02	230 V-50/60 Hz	IP-44	2	RM-02	81	81	66
RM-1	230 V-50/60 Hz	IP-54	3	RM-1	80	145	80
RM-2	230 V-50/60 Hz	IP-54	5	RM-2	96	164	85
RM-3	230 V-50/60 Hz	IP-54	10	RM-3	96	164	85



C2V

Switch for two-speed motors

Features:

- 1-0-2 three-position switch to operate two-speed motors with Dahlander connection
- IP67 protection

Model	Intensity (A)	(kW)	Cables input (mm)
C2V-CG10 A441	20	5.5	20

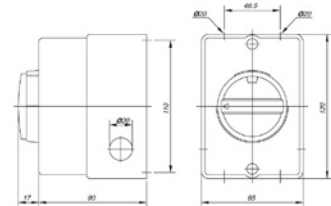

AR

Soft starters for three-phase motors.

Features:

- Especially designed to reduce the current peak caused during start-up of fans with three-phase motors.
- Supplied voltage 400V + - 10% 50/60Hz
- Mounted in box for DIN-35 rail
- Possibility of adjusting the starting torque, acceleration time and deceleration time.

Model	AR-2	AR-4	AR-7.5	AR-10	AR-15	AR-20	AR-30
Supplied voltage	400 V ±10% 50/60 Hz						
Motor power in kW at 400 V	1.5	3	5.5	7.5	11	15	22
Minimum motor power	40% of the motor's nominal power			20% of the motor's nominal power			
External fuses (quick-action) in (A)	16	25	35	25	35/40	50	63
Nominal current in (A)	3.5	6.5	12	17	25	32	45
Adjustment range of start-up torque	From 0 to 80%						
Adjustment range of start-up time	From 0.5 to 12 s			From 0.5 to 10 s			
Braking torque	Level set at 70%						
Adjustment range of deceleration time	From 0.5 to 12 s			From 0.5 to 10 s			
Setup time	200 ms						
Working temperature	0°C....45°C						
Storage temperature	-25°C....75°C						
Protection level	IP20						
Environmental conditions	Overpressure category III. Pollution level 2						
Power reduced with max. temperature	1% for every 1°C increase in the maximum temperature						
Maximum height for mounting	Up to 1000 m						
Power reduced with max. height	0.5% for every 100 m over 1000 m.						
Humidity	93% maximum without condensation						
Maximum cycles per hour (3 x I nom. 10 sec)	90/h	60/h	30/h	60/h	40/h	30/h	20/h
Weight in kg.	0.4			1.0			
Measurements	Width (W) mm	45			45		52.5
	Height (H) mm	73			173		178
	Depth (D) mm	122			152		158
Assembly	Fixing A x B			On DIN guide rail			



VSD3/A-RFT VSD1/A-RFM

Variable speed drives for AC motors

Features:

- Converter for varying the speed, via voltage and frequency, of axial and centrifugal fans with asynchronous three-phase motors
- Converter power supply:
 - . Single-phase (VSD1/A-RFM): 200-240V 50/60 Hz
 - . Three-phase (VSD3/A-RFT): 380-480V 50/60 Hz
- Compliant with the Electromagnetic Compatibility Directive 2004/108/EC, the Low Voltage Directive 2006/95/EC and the Safety of Machinery Directive 2006/42/EC.
- Compliant with the following standards: EN 61800-3:2004: Adjustable speed electrical power drive systems. Product standard regarding EMC requirements and specific test methods. EN 61800-5-1:2003: Adjustable speed electrical power drive systems. Safety requirements. Electrical, thermal and energy. EN 60204-1:2006: Safety of Machinery. Electrical Equipment of Machines. General requirements. EN 55011:2007: Industrial, scientific and medical (ISM) radio-frequency Equipment. Electromagnetic disturbance characteristics. Limits and methods of measurement. EN 60529:1992: Specifications for degrees of protection provided by enclosures.
- On/Off input to enable/disable the variable speed drive.
- 0-10V input for speed control.
- Connection available to ModBus RTU bus.
- Standard model with degree of protection IP20. Also available in IP66 version up to 10 HP.

1 In general, all SODECA fans with a three-phase motor under normal operating conditions are suitable for working with power supplied by a static frequency converter (in accordance with IEC 60034-17). Nevertheless, some motors require special measures. The maximum operating frequency or speed must never exceed that for which the fan has been designed. In applications with quadratic torques such as fans and pumps, when the speed varies the absorbed power is directly proportional to the cube of the rotating speed: $P_{a2} = P_{a1} (n_2 / n_1)^3$

2 The insulation of motors coupled to fans is sufficient to work without restrictions with a frequency converter up to voltages of < 500 V. The use of sinusoidal filters at the converter output will help the motor to operate properly, reducing breakdowns and increasing the fan's service life. It is recommended that motors of sizes > 225 be ordered with special windings to work with a frequency converter.

3 The length of the wires running from the converter to the fan have a particular influence on voltage characteristics at the motor terminals. The definition of "long wires" will depend on the nominal value and the converter type. The manufacturer's technical documentation must be consulted.

4 Ex-d flame-resistant motors must be ordered for operation using a frequency converter. The motor manufacturer will request information about the application via a questionnaire in order to establish the working parameters. These motors must also be fitted with PTC probes.

5 Ex-e increased safety motors cannot be operated with a frequency converter (a joint motor-converter certification would be required for this).

VSD1/A-RFM

Model		VSD1/A-RFM-0,5	VSD1/A-RFM-1	VSD1/A-RFM-2	VSD1/A-RFM-3
Power	(HP)	0.50	1.00	2.00	3.00
Power	(kW)	0.37	0.75	1.50	2.20
Maximum Current	(A)	2.3	4.3	7.0	10.5
Input					
Input type		Single-phase	Single-phase	Single-phase	Single-phase
Voltage	(V)	200-240 V	200-240 V	200-240 V	200-240 V
Frequency	(Hz)	50-60 Hz	50-60 Hz	50-60 Hz	50-60 Hz
Output					
Output type		Three-phase	Three-phase	Three-phase	Three-phase
Voltage	(V)	200-240 V	200-240 V	200-240 V	200-240 V
Frequency	(Hz)	0-500 Hz	0-500 Hz	0-500 Hz	0-500 Hz
Degrees of protection		Standard: IP20. On request: IP66.			
Cooling		IP20: Forced. IP66: Natural			

VSD3/A-RFT

Model		VSD3/A-RFT-1	VSD3/A-RFT-2	VSD3/A-RFT-3	VSD3/A-RFT-5.5	VSD3/A-RFT-7.5	VSD3/A-RFT-10	VSD3/A-RFT-15	VSD3/A-RFT-20	VSD3/A-RFT-25	VSD3/A-RFT-30	
Power	(HP)	1.00	2.00	3.00	5.50	7.50	10.00	15.00	20.00	25.00	30.00	
Power	(kW)	0.75	1.50	2.20	4.00	5.50	7.50	11.00	15.00	18.50	22.00	
Maximum Current(A)		2.2	4.1	5.8	9.5	14.0	18.0	24.0	30.0	39.0	46.0	
Input												
Input type		Three-phase	Three-phase	Three-phase	Three-phase	Three-phase	Three-phase	Three-phase	Three-phase	Three-phase	Three-phase	
Voltage	(V)	380-480 V	380-480 V	380-480 V	380-480 V	380-480 V	380-480 V	380-480 V	380-480 V	380-480 V	380-480 V	
Frequency	(Hz)	50-60 Hz	50-60 Hz	50-60 Hz	50-60 Hz	50-60 Hz	50-60 Hz	50-60 Hz	50-60 Hz	50-60 Hz	50-60 Hz	
Output												
Output type		Three-phase	Three-phase	Three-phase	Three-phase	Three-phase	Three-phase	Three-phase	Three-phase	Three-phase	Three-phase	
Voltage	(V)	380-480 V	380-480 V	380-480 V	380-480 V	380-480 V	380-480 V	380-480 V	380-480 V	380-480 V	380-480 V	
Frequency	(Hz)	0-500 Hz	0-500 Hz	0-500 Hz	0-500 Hz	0-500 Hz	0-500 Hz	0-500 Hz	0-500 Hz	0-500 Hz	0-500 Hz	
Degrees of protection		Standard: IP20. On request: IP66						IP20	IP20	IP20	IP20	
Cooling		IP20 and IP55: Forced. IP66: Natural										



KME - 10K

External control kit for On/Off and velocity control for VSD1/A-RFM and VSD3/A-RFT frequency converters

Features:

- On/Off by button
- Display by means of LED of the position of On or Off
- Memory of the latest position for speed regulation
- Possibility of installation on the surface or built-in



GMP

Electrical starter panel and protection of fans with three-phase motor. with On/Off buttons

Features:

- On/Off by button
- Incorporates fully-cabled contactor and adjustable thermal relay for protection of the motor
- The Off button is used to reset the thermal relay, in case it should go off due to overload
- For assembly on the surface, IP-55 protection

For fan with three-phase motor 230V

Model	Intensity regulation (A)	Power motor 3x230V (kW)
GMP-0.2-0.33/230	1.2-1.8	0.25
GMP-02-0.75/230	1.8-2.8	0.37 / 0.55
GMP-02-1/230	2.8-4	0.75
GMP-02-1.5/230	4-6.3	1.10
GMP-02-2/230	5.6-8	1.50
GMP-04-3/230	7-10	2.20
GMP-04-4/230	8-12.5	3.00
GMP-04-5.5/230	11-17	4.00
GMP-04-7.5/230	15-23	5.50
GMP-04-10/230	22-32	7.50
GMP-06-12.5/230	25-40	9.20
GMP-06-15/230	25-40	11.00

For fan with three-phase motor 400V

Model	Intensity regulation (A)	Power motor 3x400V (kW)
GMP-0.2-0.33/400	0.56-0.8	0.25
GMP-02-0.5/400	0.8-1.2	0.37
GMP-02-0.75/400	1.2-1.8	0.55
GMP-02-1.5/400	1.8-2.8	1.10
GMP-02-2/400	2.8-4	1.50
GMP-02-3/400	4-3	2.20
GMP-02-4/400	5.6-8	3.00
GMP-04-5.5/400	7-10	4.00
GMP-04-7.5/400	8-12.5	5.50
GMP-04-10/400	11-17	7.50
GMP-06-12.5/400	15-23	9.20
GMP-06-15/400	15-23	11.00
GMP-06-20/400	22-32	15.00
GMP-06-25/400	25-40	18.50



GMM

Electrical starter panel and protection from overload and short-circuits of fans with three-phase motor, with rotary controls

Features:

- On/Off by means of a rotary control with the possibility of blocking with three locks
- Incorporates adjustable thermal relay for protection from overload and short-circuit
- For assembly on the surface, IP-55 protection

For fan with three-phase motor 400V

Model	Intensity regulation (A)	Power motor 3x400V (kW)
GMM-01-1/400	1.6-2.5	0.75
GMM-01-2/400	2.5-4	1.10 1.50
GMM-01-3/400	4-6.3	2.20
GMM-01-5.5/400	6.3-10	3.00 4.00
GMM-01-7.5/400	10-16	5.50
GMM-01-10/400	16-20	7.50
GMM-01-15/400	20-25	11.00
GMM-01-20/400	25-32	15.00



AET

Electrical starter panel, star / triangle and protection of fans with three-phase motor, with On/Off buttons

Features:

- On/Off by button
- Display of condition by means of luminous pilot lights
- Incorporates adjustable thermal relay for protection of the motor
- Fully cabled
- Metal plate for assembly on the surface, IP-65 protection

For fan with three-phase motor 230V/400V. Power supply 3x230V

Model	Current regulation of thermal relay (A)	Power motor 3x230/400V (kW)
AET-01-3/230	4-6.3	2.2
AET-01-4/230	5-8	3.0
AET-01-5.5/230	7-10	4.0
AET-01-7.5/230	12-18	5.5
AET-01-10/230	12-18	7.5
AET-01-15/230	18-26	11.0
AET-01-20/230	24-36	15.0
AET-01-25/230	28-40	18.5
AET-02-30/230	34-50	22.0
AET-02-40/230	45-65	30.0
AET-02-50/230	63-85	37.0

For fan with three-phase motor 400V/690V. Power 3x400V+N

Model	Current regulation of thermal relay (A)	Power motor 3x400/690V (kW)
AET-01-5.5/400	4-6.3	4.0
AET-01-7.5/400	5-8	5.5
AET-01-10/400	7-10	7.5
AET-01-15/400	12-18	11.0
AET-01-20/400	12-18	15.0
AET-02-30/400	18-26	18.5 22.0
AET-02-40/400	28-40	30.0
AET-02-50/400	34-50	37.0
AET-02-60/400	45-65	45.0
AET-02-75/400	45-65	55.0



AD Electrical starter panel and protection of fans with three-phase motor, with two DAHLANDER speeds

Features:

- Switch for selecting speed (1-0-2). Low-Off-High
- Display of condition by means of luminous pilot lights
- Incorporates adjustable thermal relay for protection of the motor
- Fully cabled
- Metal plate for assembly on the surface, IP-65 protection

For fan with three-phase 400V Dahlander motor.
Power 3x400V+N

Model	Current regulation of thermal relay	
	High speed (A)	Low speed (A)
AD-01-2.5-1/400	1.6-2.5	0.63-1
AD-01-4-1.6/400	2.5-4	1-1.6
AD-01-4-2.5/400	2.5-4	1.6-2.5
AD-01-6-2.5/400	4-6	1.6-2.5
AD-01-9-2.5/400	6-9	1.6-2.5
AD-01-9-4/400	6-9	2.5-4
AD-02-13-4/400	9-13	2.5-4
AD-02-18-6/400	12-18	4-6
AD-02-18-9/400	12-18	6-9
AD-02-26-9/400	18-26	6-9
AD-02-36-9/400	24-36	6-9
AD-02-36-13/400	24-36	9-13
AD-02-40-18/400	28-40	12-18



PL Plastic backdraught louvres.

Features:

- The backdraught louvre is adapted directly to the wall where the fan is mounted
- Opening through excess pressure due to airflow
- Closed when the fan is on standby
- Made from plastic
- Maximum recommended speed 12m/sec for models 80, 90 and 100

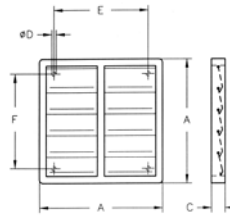

Model	Measurements					
	A	C	ØD	E	F	
PL-20	240	28	5.2	193	167	
PL-25	294	26	5	232	232	
PL-31	347	26	5	276	276	
PL-35	397	26	5	310	310	
PL-40	459	26	5	364	364	
PL-45	501	26	5	395	395	
PL-50	549	31	5	445	445	
PL-56	605	28	5	522	522	
PL-63	696	31	5	626	626	
PL-71	760	40	5	692	692	
PL-80	840	40	5	772	772	
PL-90	940	40	5	872	87	
PL-100	1040	40	5	972	972	



P Aluminium backdraught louvres

Features:

- The backdraught louvre is adapted directly to the wall where the fan is mounted
- Opening through excess pressure due to airflow
- Closed when the fan is on standby
- Aluminium sheet construction
- Maximum recommended speed 18m/sec for models 80, 90 and 100

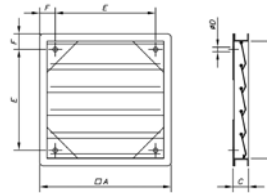

Model	Measurements					
	G	A	C	ØD	E	F
P 25	240	290	51	6	180	55
P 35	350	400	51	6	290	55
P 45	450	500	51	6	390	55
P 56	550	600	51	6	440	80
P 63	645	715	72	6	555	80
P 71	710	780	72	6	620	80
P 80	805	875	72	6	695	90
P 90	900	970	72	6	790	90
P 100	1000	1070	72	6	890	90



P-400 Backdraught louvres, certified for 400°C/2h.



Features:

- Supplied mounted in the box with appropriate adapter
- Standardisation in accordance with standard EN-12101-3- 2002, certificate no.: 0370-CPR-0312
- Frame made from sheet steel and slats from aluminium sheet
- Can be used for other 400°C/2h applications

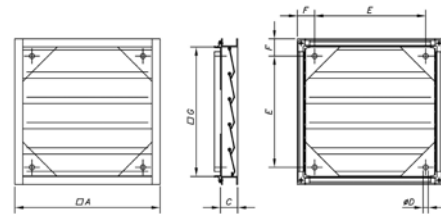

Model	G	A	C	ØD	E	F
P-400-56	565	615	51	6	455	80
P-400-63	690	760	72	6	600	80
P-400-80	850	920	72	6	740	90
P-400-100	1050	1120	72	6	940	90



R Protection guard for aspiration of axial fans

Model	HC	HCH
R-35/B	-	35
R-40	-	40
R-45	-	45
R-56	-	56-4T/M-0.75, 56-4T-1, 56-6T/M-0.33, 56-6T-0.5, 56-6T-0.75
R-56 - 1.5	-	56-4T-1.5, 56-4T-2
R-63 - 0.5	-	63-4T-1, 63-6T/M-0.5, 63-6T-0.75
R-63 - 1.5	-	63-4T-1.5, 63-4T-2, 63-6T-1
R-63 - 4	-	63-4T-3, 63-4T-4
R-71	-	71-4T-1.5, 71-4T-2, 71-6T/M-0.75, 71-6T-1, 71-6T-1.5
R-71/C*	71	
R-71-3	-	71-4T-3, 71-4T-4
R-80	-	80-6T-1, 80-6T-1.5, 80-8T-0.5, 80-8T-0.75

* these models are supplied with square grilles

Model	HC	HCH
R-80/C*	80	
R-80 - 5.5	-	80-4T-3, 80-4T-4, 80-4T-5.5, 80-6T-2, 80-6T-3, 80-8T-1
R-90	-	90-4T-4, 90-4T-5.5, 90-6T-2, 90-6T-3, 90-8T-1, 90-8T-1.5, 90-8T-2
R-90/C*	90	
R-90 - 7.5	-	90-4T-7.5, 90-4T-10, 90-6T-4, 90-8T-3
R-100	-	100-6T-3, 100-8T-1.5, 100-8T-2
R-100/C*	100	
R-100-7.5/C*	100 4T/H	
R-100 - 10	-	100-4T-7.5, 100-4T-10, 100-6T-4, 100-6T-5.5, 100-8T-1.5, 100-8T-2
R-100 - 20	-	100-4T-15, 100-4T-20



RI Protection guard for inlet or outlet of long-cased axial fans

Model	HEP	HCD	HC	HRE	HCH	Model	HEP	HCD	HC	HRE	HCH
RI-20	-	20	-	-	-	RI-45	45	-	45	-	45
RI-25/E	-	-	-	25	-	RI-50	50	-	50	-	-
RI-25	25	25	25	-	-	RI-56	56	-	56	-	56
RI-31/E	-	-	-	31	-	RI-63	63	-	63	-	63
RI-31	31	30	31	-	-	RI-71	-	-	71	-	71
RI-35/E	-	-	-	35	-	RI-80	-	-	80	-	80
RI-35/B	-	-	-	-	35	RI-90	-	-	90	-	90
RI-35/C	35	35	35	-	-	RI-100	-	-	100	-	100
RI-40	40	40	40	-	40						



RT Protection guard for inlet or outlet of long-cased axial fans

Model	HEPT	HCT	HGT	HPX	Model	HEPT	HCT	HGT	HPX	Model	HEPT	HCT	HGT	HPX
RT-25	-	25	-	-	RT-45	45	45	-	45	RT-80	-	80	-	80
RT-31/B	-	31	-	-	RT-50	50	50	-	50	RT-90	-	90	-	90
RT-31	31	-	-	-	RT-56	56	56	-	56	RT-100	-	100	-	100
RT-35	35	35	-	35	RT-63	63	63	-	63	RT-125	-	-	125	-
RT-40	40	40	-	-	RT-71	-	71	-	71	RT-125/CC	-	-	125	-



PV Inlet hood for use with the HEPT, HCT, HGT, HTP and THT series

Model	øA	øB	ØC	øD	ød	E	M	H	Model	øA	øB	ØC	øD	ød	E	M	H
PV-31	398	355	426	320	10	15	8x45°	165	PV-80	904	860	915	797	12	2	16x22.5°	250
PV-35	438	395	435	359	10	15	8x45°	165	PV-90	1004	970	1015	894	14	2	16x22.5°	250
PV-40	484	450	507	401	12	15	8x45°	165	PV-100	1105	1070	1115	1003	14	2	16x22.5°	250
PV-45	534	500	555	450	12	15	8x45°	165	PV-125	1370	1320	1364	1240	14	2	20x18°	250
PV-50	584	560	617	504	12	15	12x30°	165	PV-140	1533	1470	1673	1413	15	3	20x18°	250
PV-56	664	620	667	565	12	15	12x30°	165	PV-160	1705	1680	1866	1585	19	3	24x15°	315
PV-63	734	690	757	634	12	15	12x30°	165	PV-180	1908	1830	1923	1788	19	3	24x15°	315
PV-71	812	770	816	711	12	2	16x22.5°	250	PV-200	2113	2080	2128	1993	19	3	24x15°	315



BTUB Coupling flange for axial fans

Model	HEPT	HCT	HGT	HPX	HT*	Model	HEPT	HCT	HGT	HPX	HT*	Model	HEPT	HCT	HGT	HPX	HT*
BTUB-250	-	25	-	-	25	BTUB-500	50	50	-	50	50	BTUB-1000	-	100	-	100	100
BTUB-280	-	31	-	-	-	BTUB-560	56	56	-	56	56	BTUB-1250	-	-	125	-	-
BTUB-315	31	-	-	-	31	BTUB-630	63	63	-	63	63	BTUB-1400	-	-	140	-	-
BTUB-355	35	35	-	-	35	BTUB-710	-	71	-	71	71	BTUB-1600	-	-	160	-	-
BTUB-400	40	40	-	-	40	BTUB-800	-	80	-	80	80						
BTUB-450	45	45	-	45	45	BTUB-900	-	90	-	90	90						

* For installation, the PA accessory must be used



B Coupling flange for centrifugal fans

- Features:
- Adapted to inlet and outlet
 - Aids installation on duct

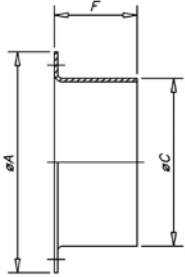

	A	C	F
B-52-E	100	52	67
B-63	110	63	60
B-80	150	80	60
B-80-E	150	80	60
B-100	150	100	60
B-100-E	170	100	60
B-112	160	112	60
B-125	180	125	60
B-140	190	140	60
B-150	210	150	60
B-160	220	160	60
B-160/1	220	160	60
B-160/2	310	160	80
B-180	240	180	60
B-180/1	240	180	60

	A	C	F
B-200	260	200	60
B-224	280	224	60
B-250/1	310	250	80
B-250/2	310	250	80
B-250/3	310	250	80
B-250/4	310	250	80
B-250/5	310	250	80
B-280/1	350	280	80
B-280/2	350	280	80
B-280/3	350	280	80
B-315/1	350	315	80
B-315/2	380	315	80
B-315/3	380	315	80
B-315/4	380	315	80
B-315/5	380	315	80

	A	C	F
B-355/1	430	355	80
B-355/2	430	355	80
B-355/3	430	355	80
B-355/4	430	355	80
B-400/1	480	400	80
B-400/2	480	400	80
B-400/3	480	400	80
B-400/4	480	400	80
B-450/1	530	450	80
B-450/2	530	450	80
B-450/3	530	450	80
B-500/1	590	500	80
B-500/2	590	500	80
B-500/3	590	500	80
B-500/4	590	500	80

	A	C	F
B-500/5	590	500	80
B-560/1	650	560	80
B-560/2	650	560	80
B-560/3	650	560	80
B-630/1	720	630	80
B-630/2	720	630	80
B-630/3	720	630	80
B-630/4	720	630	80
B-710/1	800	710	80
B-710/2	800	710	80
B-710/3	800	710	80
B-800	890	800	100
B-900/1	1000	900	100
B-1000/1	1100	1000	100

Model	CHT/CVT	CHRE
B-52-E	-	-
B-63	-	-
B-80	-	-
B-80-E	-	-
B-100	-	-
B-100-E	-	-
B-112	-	-
B-125	-	-
B-140	-	-
B-150	-	-
B-160	-	-
B-160/1	-	722

Model	CHT/CVT	CHRE
B-160/2	-	-
B-180	-	825
B-180/1	-	-
B-200	-	-
B-224	-	-
B-250/1	-	-
B-250/2	-	-
B-250/3	200/225	1131
B-250/4	-	-
B-250/5	-	-
B-280/1	-	-
B-280/2	-	-

Model	CHT/CVT	CHRE
B-280/3	-	-
B-315/1	-	-
B-315/2	-	-
B-315/3	-	-
B-315/4	-	-
B-315/5	-	-
B-355/1	-	-
B-355/2	-	-
B-355/3	250/315	1135/1240
B-355/4	-	-
B-400/1	-	-
B-400/2	-	-

Model	CHT/CVT	CHRE
B-400/3	-	-
B-400/4	-	-
B-450/1	-	-
B-450/2	-	-
B-450/3	-	-
B-500/1	-	-
B-500/2	-	-
B-500/3	-	-
B-500/4	400/450	1445/1650
B-560/1	-	-
B-560/2	-	-

Model	CHT/CVT	CHRE
B-560/3	-	-
B-630/1	-	-
B-630/2	-	-
B-630/3	500	-
B-630/4	-	-
B-710/1	-	-
B-710/2	560/630	-
B-710/3	-	-
B-800	-	-
B-900/1	-	-
B-1000/1	-	-

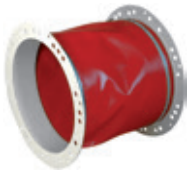

BAC Double, elastic coupling flange for axial fans

- Features:
- Adapted to inlet and outlet
 - Aids installation on duct with flange
 - Prevents transmission of vibrations

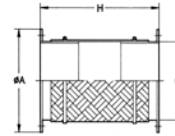

Model	HEPT	HCT	HGT	CHT	HT	HPX	CHRE
BAC-160	-	-	-	-	-	-	722
BAC-180	-	-	-	-	-	-	825
BAC-250	-	25	-	200/225	25	-	1131
BAC-315/B	-	31	-	-	-	-	-
BAC-315	31	-	-	-	31	-	-
BAC-355	35	35	-	250/315	35	35	1135/1240
BAC-400	40	40	-	-	40	-	-
BAC-450	45	45	-	-	45	45	-

Model	HEPT	HCT	HGT	CHT	HT	HPX	CHRE
BAC-500	50	50	-	400/450	50	50	1145/1650
BAC-560	56	56	-	-	56	56	-
BAC-630	63	63	-	500	63	63	-
BAC-710	-	71	-	560/630	71	71	-
BAC-800	-	80	-	-	80	80	-
BAC-900	-	90	-	-	90	90	-
BAC-1000	-	100	-	-	100	100	-
BAC-1250	-	-	125	-	-	-	-

	ØD*	ØA*	H
BAC-160	160	220	340
BAC-180	180	240	340
BAC-250	250	310	340
BAC-315/B	280	350	340
BAC-315	315	380	340
BAC-355	355	430	340
BAC-400	400	480	340
BAC-450	450	530	340
BAC-500	500	590	340
BAC-560	560	650	340
BAC-630	630	720	340
BAC-710	710	800	340
BAC-800	800	890	340
BAC-900	900	1000	340
BAC-1000	1000	1100	340
BAC-1250	1250	1365	340

*Nominal diameter for pipe.



PS Support stands for long-cased fans

- Features:
- When fixed to the flange, it allows the fan to be fixed to flat surfaces

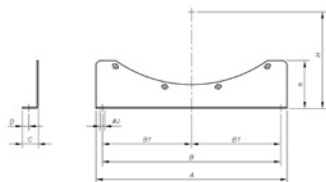

	A	B	B1	C	D	h	H	ØJ
PS-25/31	275	225	-	25	10.5	90	165	10
	275	225	-	25	10.5	90	191.5	10
	275	225	-	25	10.5	90	205	10
PS-35/40	240	200	-	30	13	60	230	10
	240	200	-	30	13	60	255.5	10
PS-45/50	450	400	200	35	14.5	125	278	12
	450	400	200	35	14.5	125	305	12
PS-56/63	520	430	215	40	17	155	338	13
	520	430	215	40	17	155	385.5	13
PS-71	490	450	225	50	21	150	445	13
PS-80	600	560	280	50	21	150	490	13
PS-90	620	560	280	60	28	175	547.5	18
PS-100	680	560	280	60	28	185	597.5	18
PS-125	1000	900	300	60	28	285	726.5	18

	HEPT	HCT	HGT	HPX
	-	25	-	-
	-	31	-	-
	-	31	-	-
	35	35	-	35
	40	40	-	-
	45	45	-	45
	50	50	-	50
	56	56	-	56
	63	63	-	63
	-	71	-	71
	-	80	-	80
	-	90	-	90
	-	100	-	100
	-	-	125	-



MS

Support frame to facilitate mounting on-site

Features:

- Used to facilitate on-site mounting of fans in ducts

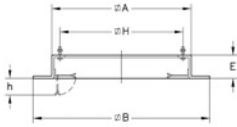

	ØA	ØB	E	ØH	h
MS-348	348	520	60	295	70
MS-393	393	565	60	320	70
MS-443	443	615	60	360	70
MS-493	493	665	60	410	70
MS-553	553	725	60	450	70

	ØA	ØB	E	ØH	h
MS-623	623	795	60	530	70
MS-701	701	875	60	590	90
MS-791	791	965	60	680	90
MS-891	891	1065	60	750	90
MS-991	991	1165	60	850	90
MS-1086	1086	1260	60	900	90
MS-1140	1140	1314	60	1000	90
MS-1240	1240	1414	60	1100	90

Model	CHT/CVT	HT	CHRE
MS-348	-	-	722
MS-393	-	-	825
MS-443	200/225	25	1131
MS-493	-	31	-
MS-553	250/315	35	1135/1240
MS-623	-	40	-
MS-701	400/450	45	1445/1650
MS-791	-	50	-
MS-891	500	56	-
MS-991	-	63/71	-
MS-1086	560/630	-	-
MS-1140	-	80/90	-
MS-1240	-	100	-



PA

Adaptation plate to mount accessories on roof fans

Features:

- Used to mount PT, B, BTUB, BAC accessories.
- Allows fan to be separated from its base without dismantling accessories

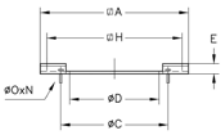

	ØA	ØC	ØD	E	ØH	ØO	N
PA-345	345	200	165	20	245	M.8	4x90°
PA-390	390	210	190	20	320	M.8	4x90°
PA-440/250	440	280	249	20	360	M.6	4x90°
PA-490	490	355	314	20	410	M.8	8x45°
PA-550	550	395	354	20	450	M.6	8x45°
PA-620	620	450	399	20	530	M.10	8x45°
PA-700/500	700	560	499	20	590	M.10	12x30°
PA-700/450	700	500	449	20	590	M.10	8x45°

	ØA	ØC	ØD	E	ØH	ØO	N
PA-790	790	560	499	20	680	M.10	12x30°
PA-890/630	890	690	629	20	750	M.10	12x30°
PA-890/560	890	620	569	20	750	M.10	12x30°
PA-990/630	990	690	629	20	850	M.10	12x30°
PA-990/710	990	770	709	20	850	M.10	16x22°30'
PA-1085	1088	770	704.5	20	900	M.10	16x22°30'
PA-1138/800	1138	860	704.5	25	900	M.10	16x22°30'
PA-1138/900	1138	970	899	25	1000	M.12	16x22°30'
PA-1238	1238	1070	999	25	1100	M.12	16x22°30'

Model	CHT/CVT	HT	CHRE
PA-345	-	-	722
PA-390	-	-	825
PA-440/250	200/225	25	1131
PA-490	-	31	-
PA-550	250/315	35	1135/1240
PA-620	-	40	-
PA-700/500	400/450	-	1445/1650
PA-700/450	-	45	-
PA-790	-	50	-
PA-890/630	500	-	-
PA-890/560	-	56	-
PA-990/630	-	63	-
PA-990/710	-	71	-
PA-1085	560/630	-	-
PA-1138/800	-	80	-
PA-1138/900	-	90	-
PA-1238	-	100	-



BS BSS

High base plate and high base plate with silencer

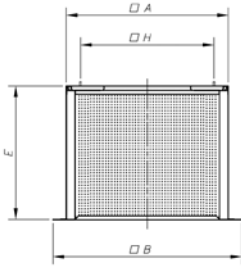

Model	A	B	H	E	CHT/CVT	HT	CHRE
BS BSS - 348	348	520	295	800	-	-	722
BS BSS - 393	393	565	320	800	-	-	825
BS BSS - 443	449	616	360	800	200/225	25	1131
BS BSS - 493	493	665	410	800	-	31	-
BS BSS - 553	554	724	450	800	250/315	35	1135/1240
BS BSS - 623	623	795	530	800	-	40	-
BS BSS - 701	706	876	590	900	400/450	45	1445-1650
BS BSS - 791	791	965	680	900	-	50	-
BS BSS - 891	896	1076	750	900	500	56	-
BS BSS - 991	991	1165	850	900	-	63/71	-
BS BSS - 1086	1092	1272	900	900	560/630	-	-
BS BSS - 1140	1140	1314	1000	900	-	80/90	-
BS BSS - 1240	1240	1414	1100	900	-	100	-



PT PT-...-400

Automatic-closing shutters to work in vertical and horizontal position version 400, certified for 400°C/2h

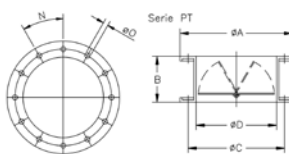

PT/H

PT.../H-400

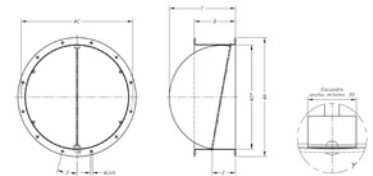

	ØA	B	ØC	ØD*	ØO	N	CHT/CVT	CHRE
PT-160	220	150	200	160	10	4x90°	-	722
PT-180	240	150	210	180	10	4x90°	-	825
PT-250	310	150	280	250	10	4x90°	200/225	1131
PT-355	435	200	395	355	10	8x45°	250/315	1135/1240
PT-500	600	280	560	500	12	12x30°	400/450	1445/1650
PT-630	730	355	690	630	12	12x30°	-	500
PT-710	810	400	770	710	12	16x22°30'	560/630	-

	ØA	B	ØC	ØD*	E	F	B	ØJ	N
PT-450/H	540	254	500	460	185	340	22° 30'	12	8x45°
PT-500/H	600	254	560	514	185	346	15°	12	12x30°
PT-560/H	660	254	620	560	185	363	15°	12	12x30°
PT-630/H	730	254	690	640	185	409	15°	12	12x30°
PT-710/H	810	254	770	710	185	443	11°15'	12	16x22°30'
PT-800/H	900	254	860	800	185	488	11°15'	12	16x22°30'
PT-900/H	1015	254	970	900	185	555	11°15'	15	16x22°30'
PT-1000/H	1115	254	1070	1000	185	609	11°15'	15	16x22°30'
PT-1250/H	1365	254	1320	1250	185	736.5	9°	15	20x18°

*Nominal duct diameter





OP

Backdraught shutters for roof fans

OP-25	HT-25	OP-40	HT-40	OP-56	HT-56	OP-80	HT-80
OP-31	HT-31	OP-45	HT-45	OP-63	HT-63	OP-90	HT-90
OP-35	HT-35	OP-50	HT-50	OP-71	HT-71	OP-100	HT-100



REG

Record of manual regulation

Features:

- Their design allows them to be installed in ducting systems to adjust the airflow

Modelo	L	ØD*	Modelo	L	ØD*
REG-80	100	80	REG-250	100	250
REG-100	100	100	REG-280	100	280
REG-112	100	112	REG-315	100	315
REG-125	100	125	REG-355	100	355
REG-140	100	140	REG-400	100	400
REG-150	100	150	REG-450	150	450
REG-160	100	160	REG-500	150	500
REG-180	100	180	REG-560	150	560
REG-200	100	200	REG-630	250	630
REG-224	100	224	REG-800	250	800



S

Silencers to fit to inlet or outlet

Features:

- Circular or rectangular silencers to fit to inlet or outlet on centrifugal or axial fans

INLET / OUTLET (Rectangular cross section)

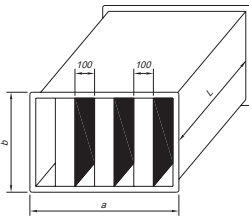

L	a	b	Kg	Replacement dampers (dB) on octave band (Hz)						Applicable	
				125	250	500	1000	2000	4000		
SR-1000/900/900	900	1000	900	64	4	10	21	37	44	37	HCH/HCT/THT-63
SR-1200/900/900	900	1200	900	74	4	10	21	37	44	37	HCH/HCT/THT-71
SR-1400/1200/900	900	1400	1200	102	4	12	25	41	47	42	HCH/HCT/THT-80
SR-1800/1200/1200	1200	1800	1200	169	4	12	25	41	47	42	HCH/HCT/THT-90
SR-1800/1500/1200	1200	1800	1504	195	4	12	25	41	47	42	HCH/HCT/THT-100

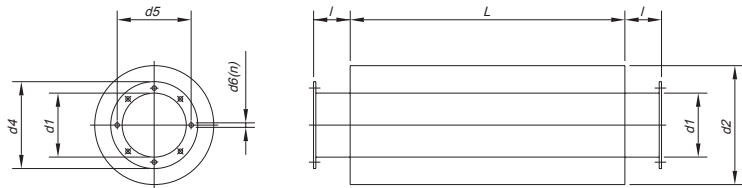

INLET / OUTLET (Circular cross section)

L	d1	d2	l	d3	d4	d5	d6	n	Kg	Replacement dampers (dB) on octave band (Hz)						Applicable	
										125	250	500	1000	2000	4000		
SC-630/900	900	630	800	100	630	720	690	12	12x30°	44	5	8	14	12	13	9	HCH/HCT/THT-63
SC-710/900	900	710	900	100	710	800	770	12	16x22°30'	65	5	8	13	11	12	8	HCH/HCT/THT-71
SC-800/900	900	800	1000	100	800	900	860	12	16x22°30'	70	4	8	11	9	9	8	HCH/HCT/THT-80
SC-900/1200	1200	900	1120	100	900	1000	970	15	16x22°30'	87	5	7	11	11	7	5	HCH/HCT/THT-90
SC-1000/1200	1200	1000	1200	100	1000	1100	1070	15	16x22°30'	95	4	7	11	10	7	6	HCH/HCT/THT-100

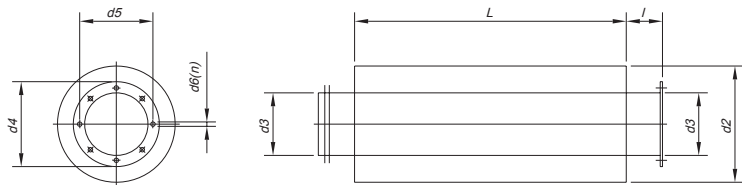

INLET

L	d2	d3	d4	d5	d6	n	Kg	Replacement dampers (dB) on octave band (Hz)						Applicable	
								125	250	500	1000	2000	4000		
S-160/600-A	600	260	160	220	200	10	4x90°	6	3	11	22	33	42	29	CHRE-722
S-180/600-A	600	300	180	240	210	10	4x90°	7	4	8	15	31	28	20	CHRE-825
S-250/600-A	600	450	250	310	280	10	4x90°	14	5	12	20	24	23	14	CVT-CHT-200/225 HT-25 / CHRE-1131
S-315/900-A	900	500	315	390	355	10	8x45°	22	4	12	21	26	19	15	HT-31
S-355/900-A	900	560	355	430	395	10	8x45°	25	4	12	20	24	18	14	CVT-CHT-250/315 HT-35 / CHRE-1135/1240
S-400/900-A	900	600	400	480	450	12	8x45°	29	5	12	19	22	18	13	HT-40
S-450/900-A	900	630	450	530	500	12	8x45°	32	5	12	18	20	16	12	HT-45
S-500/900-A	900	710	500	590	560	12	12x30°	35	4	11	18	16	14	11	CVT-CHT-400/450 HT-50 / CHRE-1445/1650
S-560/900-A	900	750	560	650	620	12	12x30°	41	4	10	16	14	13	10	HT-56
S-630/900-A	900	800	630	720	690	12	12x30°	44	5	8	14	12	13	9	CVT-CHT-500 / HT-63
S-710/900-A	900	900	710	800	770	12	16x22°30'	65	5	8	13	11	12	8	CVT-CHT-560/630 HT-71
S-800/900-A	900	1000	800	900	860	12	16x22°30'	70	4	8	11	9	9	8	HT-80
S-900/1200-A	1200	1120	900	1000	970	12	16x22°30'	85	5	7	11	11	7	6	HT-90
S-1000/1200-A	1200	1200	1000	1100	1070	12	16x22°30'	95	4	7	11	10	7	6	HT-100



MOTORES IE-2 Three-phase asynchronous motors

Features:

- Speeds: 2, 4, 6 and 8 poles
- Three-phase power 230/400V 50Hz up to 5.5CV, and 400/690V 50Hz for greater power
- Form of construction IM B3 (IM 1001)
- Closed motors, with external ventilation (IC 411)
- Degree of protection IP-55
- Class F insulation
- S1 Service

On request:

- Other forms of construction
- Single-phase motors
- Two-speed motors

Regulations:

- They fulfil the following international regulations:



Electric regulations

General prescriptions on electrical machines	IEC/EN 60034-1
Marking of terminals and direction of rotation	IEC 60034-8
Start up characteristics of three-phase induction motors	IEC 60034-12
Insulating materials	IEC 60085
Standardised voltages	IEC 60038

Mechanical regulations

Dimensions and assigned power	IEC 60072
Degrees of protection (Code IP)	IEC/EN 60034-5
Methods of refrigeration	IEC/EN 60034-6
Forms of construction	IEC/EN 60034-7
Noise maximum values	IEC/EN 60034-9
Mechanical vibrations	IEC 60034-14

3000 r/min = 2 poles 50Hz

Type of motor	Power (kW)	Power (CV)	Speed (r/min)
MOTOR-56 1-2T	0.09	0.12	2670
MOTOR-56 2-2T	0.12	0.16	2730
MOTOR-63 1-2T	0.18	0.25	2710
MOTOR-63 2-2T	0.25	0.33	2710
MOTOR-71 1-2T	0.37	0.5	2730
MOTOR-71 2-2T	0.55	0.75	2760
MOTOR-80 1-2T	0.75	1	2770
MOTOR-80 2-2T	1.1	1.5	2770
MOTOR-90S-2T	1.5	2	2840
MOTOR-90L-2T	2.2	3	2840
MOTOR-100L-2T	3	4	2840
MOTOR-112M-2T	4	5.5	2880
MOTOR-132S 1-2T	5.5	7.5	2900
MOTOR-132S 2-2T	7.5	10	2920
MOTOR-160M 1-2T	11	15	2940
MOTOR-160M 2-2T	15	20	2940
MOTOR-160L-2T	18.5	25	2940

1500 r/min = 4 poles 50Hz

Type of motor	Power (kW)	Power (CV)	Speed (r/min)
MOTOR-56 1-4T	0.06	0.08	1320
MOTOR-56 2-4T	0.09	0.12	1320
MOTOR-63 1-4T	0.12	0.17	1350
MOTOR-63 2-4T	0.18	0.25	1350
MOTOR-71 1-4T	0.25	0.33	1350
MOTOR-71 2-4T	0.37	0.5	1370
MOTOR-80 1-4T	0.55	0.75	1370
MOTOR-80 2-4T	0.75	1.00	1380
MOTOR-90S-4T	1.10	1.50	1400
MOTOR-90L-4T	1.50	2.00	1400
MOTOR-100L 1-4T	2.20	3.00	1420
MOTOR-100L 2-4T	3.00	4.00	1420
MOTOR-112M-4T	4.00	5.50	1430
MOTOR-132S-4T	5.50	7.50	1450
MOTOR-132M-4T	7.50	10.00	1450
MOTOR-160M-4T	11.00	15.00	1460
MOTOR-160L-4T	15.00	20.00	1460

1000 r/min = 6 poles 50Hz

Type of motor	Power (kW)	Power (CV)	Speed (r/min)
MOTOR-71 1-6T	0.18	0.25	880
MOTOR-71 2-6T	0.25	0.35	900
MOTOR-80 1-6T	0.37	0.50	900
MOTOR-80 2-6T	0.55	0.75	900
MOTOR-90S-6T	0.75	1.00	920
MOTOR-90L-6T	1.10	1.50	925
MOTOR-100L-6T	1.50	2.00	945
MOTOR-112M-6T	2.20	3.00	955
MOTOR-132S-6T	3.00	4.00	960
MOTOR-132M 1-6T	4.00	5.50	960
MOTOR-132M 2-6T	5.50	7.50	960
MOTOR-160M-6T	7.50	10.00	970
MOTOR-160L-6T	11.00	15.00	970

750 r/min = 8 poles 50Hz

Type of motor	Power (kW)	Power (CV)	Speed (r/min)
MOTOR-80 1-8T	0.18	0.25	680
MOTOR-80 2-8T	0.25	0.33	680
MOTOR-90S-8T	0.37	0.50	680
MOTOR-90L-8T	0.55	0.75	680
MOTOR-100L 1-8T	0.75	1.00	710
MOTOR-100L 2-8T	1.10	1.50	710
MOTOR-112M-8T	1.50	2.00	710
MOTOR-132S-8T	2.20	3.00	720
MOTOR-132M-8T	3.00	4.00	720
MOTOR-160M 1-8T	4.00	5.50	720
MOTOR-160M 2-8T	5.50	7.50	720
MOTOR-160L-8T	7.50	10.00	720

Wiring diagram

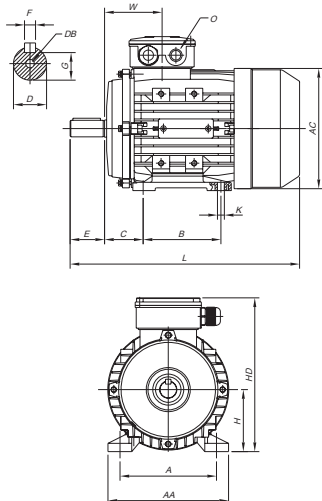
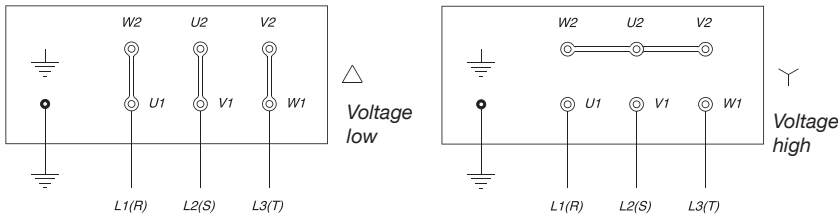

Measurements

Model	H	A	B	C	D	E	F	G	DB	K	AA	HD	AC	L	O
56	56	90	71	36	9	20	3	7.2	M3	6x8.8	110	160	120	195	1-M16X1.5
63	63	100	80	40	11	23	4	8.5	M4	6x10	120	165	130	215	1-M16X1.5
71	71	112	90	45	14	30	5	11	M5	7x10	132	180	145	245	1-M20X1.5
80	80	125	100	50	19	40	6	15.5	M6	10x13	160	217	165	290	1-M20X1.5
90S	90	140	100	56	24	50	8	20	M8	10x13	175	230	185	310	1-M20X1.5
90L1/L2	90	140	125	56	24	50	8	20	M8	10x13	175	235	185	335/365	1-M20X1.5
100	100	160	140	63	28	60	8	24	M10	12x16	196	252	205	386	1-M20X1.5
112	112	190	140	70	28	60	8	24	M10	12x16	220	292	230	395	2-M25X1.5
132/S	132	216	140	89	38	80	10	33	M12	12x16	252	330	270	436	2-M25X1.5
132M/L	132	216	178	89	38	80	10	33	M12	12x16	252	325	270	475/500	2-M25X1.5
160M	160	254	210	108	42	110	12	37	M16	15x19	335	390	320	640	2-M32X1.5
160L	160	254	254	108	42	110	12	37	M16	15x19	335	390	320	640	2-M32X1.5

Intelligent sensors for controlling the fans



Sensors which make it possible to sense certain environmental conditions and automatically start up the fans. This makes it possible to use the ventilation only when necessary. Using the sensors with the frequency inverters we can control the regime of operation of the fans, thus preventing the fan always working at its maximum consumption. These systems involve a significant energy saving.



SI-PIR-TF-Cenital



SI-PIR-TF-Mural

SI-PIR

Motion detector

Automatically activates the ventilation system when it detects the presence of people within its radius of action and keeps functioning for a pre-set time, which can be adjusted by means of an internal clock

Model	Power supply	Output	Detection angle	Ajustments	Height installation	Working temperature
SI-PIR	230V	230V	360°C	Timing 5s-30 min	2.4-4.2 m	-20° +50° C
SI-PIR-TFT-550-B	24V ac/24V dc	24V ac/24V dc	110°C	Timing 5s-30 min	1.8-3.6 m	-20° +50° C
SI-PIR-TF-25-360	24V ac/24V dc	24V ac/24V dc	360°C	Timing 10s-30 min	2.4-4.2 m	-20° +50° C



SI-SMOKE

Tobacco smoke detector

Automatically activates the ventilation system when tobacco smoke and other contaminants exceed the pre-set value in the sensor and keeps functioning for a pre-set time, which can be adjusted by means of an internal clock

Model	Power supply	Output	Detection angle	Adjustments	Height installation	Working temperature
SI-SMOKE	220-240V ac	220-240V ac	3.0	Timing 3min-20 min	1.5-2.0 m	-20° +50° C



SI-CO2

Air quality detector

Automatically activates the ventilation system when the increase in contamination, as a function of the occupation of the premises. exceeds the pre-set value

Model	Power supply	Output	Consumption (W)	Adjustments	Height installation	Working temperature
SI-CO2-GAQ24	24V ac	0-10V ac	5	Timing 10s-30 min	1.5-2.5 m	-20° +50° C



SI-CO2 IND

CO2 sensor

Model	Power supply	Output	Maximum consumption (VA)	CO2 concentration range	Working temperature
SI-CO2 IND/P	15-24V ac ±10 %/18-34V dc	0-10V dc/0-20mA	2.5	0-2000 ppm	-10 +50 °C
SI-CO2 IND/C	15-24V ac ±10 %/18-34V dc	0-10V dc/0-20mA	2.5	0-2000 ppm	0 +50 °C



SI-TEMP

Temperature sensor

Automatically activates the ventilation system when it detects a temperature greater than the pre-set value. Once the environmental temperature has descended below the pre-set point, the fan remains functioning for a pre-set period, which can be adjusted by means of the internal clock. The range of temperature oscillates between +10°C and 40°C

Model	Power supply	Output	Maximum current (A)	Adjustments	Height installation	Working temperature
SI-TEMP	220-240V ac	220-240V ac	3.0	Temporización 3min-20 min	1.5-2.0 m	+10° +40° C



SI TEMP IND

Proportional temperature sensor

Model	Power supply	Output	Maximum consumption (VA)	Working temperature
SI-TEMP IND/P	15-24V ac ±10 %/18-34V dc	0-10V dc/0-20mA	1.5	0 +50 °C



SI-TEMP+HUMEDAD

Temperature and relative humidity sensor with display

Independently controls the temperature and the relative humidity of the air on the premises. Automatically activates the ventilation system when it detects a temperature or humidity greater than the pre-set value. Once the environmental temperature or humidity has descended below the pre-set point, the fan remains functioning for a pre-set period, which can be adjusted by means of the internal clock.

Model	Power supply	Output	Adjustments	Height installation	Working temperature
SI-TEMP+HUMEDAD	24V ac	0-10V dc	$\Delta T = 0.5^{\circ}C$ y $\Delta HR = 2\%$	1.5-2.5 m	+10° +40° C



SI-HUMIDOSTATO

Humidity sensor

Model	Power supply	Output	Maximum consumption (VA)	Relative humidity range	Working temperature
SI-HUMIDOSTATO	15-24V ac ±10 %/18-34V dc	220-240V ac	2	0-100 % RH	0 +50 °C



SI-HUMEDAD

Rango Humedad relativa

Model	Power supply	Output	Maximum consumption (VA)	Relative humidity range	Working temperature
SI-HUMEDAD	15-24V ac ±10 %/18-34V dc	0-10V dc/0-20mA	2.5	0-100 % RH	0 +50 °C



SI-PRESIÓN

Pressure transmitter

Controls the pressure in installations with constant pressure ventilation, and transforms it into an electrical signal to regulate the ventilation system and constantly maintain the same pressure.

Model	Power supply	Output	Maximum consumption (VA)	Connectors	Pressure range
SI-PRESIÓN TPDA	24V ac/24V dc	0-10V/4-20mA	4	6.2 mm	0-2500 Pa
SI-PRESIÓN TPDA c/DISPLAY	24V ac/24V dc	0-10V/4-20mA	4	6.2 mm	0-2500 Pa



SI-TIMER

Timer

Adjusts the operating time of the ventilation system to which it is connected. The ventilation system is automatically activated when the light switch goes on and continues to function for a pre-set time which can be altered by means of the internal clock

Model	Power supply	Output	Maximum current (A)	Adjustments	Working temperature
SI-TIMER	220-240V ac	220-240V dc	3.0	Timing 3min-20 min	-20° +50° C



SI-FUENTE DE ALIMENTACIÓN ac



SI-FUENTE DE ALIMENTACIÓN dc

SI-FUENTE DE ALIMENTACIÓN

Power supply 24V dc / ac

Powers the intelligent 24V dc/ac sensors from an input voltage of 230V, single-phase.

Model	Power supply	Output	Power (VA)
SI-FUENTE DE ALIMENTACIÓN dc	230 V	24V dc	30
SI-FUENTE DE ALIMENTACIÓN ac	230/400 V	24/48V ac	25



CENTRAL CO

Monoxide detection centres for ventilation control in car parks

Model	Application
FMC-C-501	Centre for 1 area
FMC-C-502	Centre for 2 areas
FMC-C-503	Centre for 3 areas
FM-M-509	Module for area extension
FM-DP500	CO wall detector
FM-D500	CO ceiling detector
FM-TC500	Control card per inverter

Alphabetical index of references

CA-ROOF	144	HCRE	21	HTM	97
CHRE	139	HCT	25	HTMH	115
CHT	130	HEP	8	HTP	44
CJHCH	41	HEPT	8	HTTI	127
CTD	142	HGI	110	KITS DE SOBREPRESIÓN	111
CVT	130	HGT	60	RCH	147
HBA	102	HGTX	60	RCH-400x800VM	147
HC	13	HPX	99	RFHD	135
HCD	19	HPX/SEC	104	TIRACAMINO	146
HCH	25	HRE	21	VAC	108
HCH/SEC	106	HT	123	VAM	108

Alphabetical index of references. Accessories

AR	151	MOTORES	159	PV	155
B	156	MS	157	R	155
BAC	156	OP	158	REG	158
BS - BSS	157	P	154	RI	155
BTUB	155	P-400	154	RM	151
C2V	151	PA	157	RT	155
CUADROS ELÉCTRICOS	153	PL	154	S	158
GMM	153	PS	156	SENSORES INTELIGENTES	160
GMP	153	PT	157	VSD1/A-RFM	152
INT	151	PT/H	157	VSD3/A-RFT	152
KME-10K	153	PT/H-400	157		



THE ErP DIRECTIVE

MORE ECO-EFFICIENT FANS

What does the new "ErP" directive refer to?

The Ecodesign ErP 2009/125/CE Directive is going to encourage the economic and sustainable use of available energy resources. Its principal objectives are to encourage ecological design and to advance the struggle against climate change by means of the reduction of CO2 emissions into the atmosphere.

Over the next few years, the application of this directive will affect all products which require and consume energy so as to make them more environmentally friendly.

- By the year 2020, the EU intends to fulfil its KYOTO commitment by increasing its consumption of renewable energies as opposed to those of fossil origin by 20%.
- It is necessary to control and improve the quality of electrical devices by improving their performance through new, more efficient designs.

For this reason, specific rules for each product marketed in the EU are being developed: Electric motors, water pumps, industrial and residential fans, transformers, etc... And for this purpose, a series of studies of the different categories of devices ordered by LOTS is being carried out, which is now resulting in the appearance of the first regulations, including those for fans.

How will this ErP Directive affect fans?

The first regulation of the Commission, (EU) 327/2011, which is the fruit of the study for the "LOT 11" category, has already been published. It is going to regulate non-residential fans with electrical power of between 125W and 500kW.

This regulation sets down two phases for its complete implementation:

- 1st phase: Beginning in January 2013, applying a first stage of efficiency for fans.
- 2nd phase: Beginning in January 2015, these requirement levels will be further increased.

These two phases are related with those already applied by Directive 2009/640/EC on the efficiency of standard electric motors which came into effect in June 2011. Since this time, Sodeca has been using IE2 efficiency motors in all its fans.

In the second phase, starting in January 2015, all the electric motors used must satisfy IE3 efficiency. The only alternative is the use of IE2 motors + Inverter, or EC motors.

The efficiency of fans will improve largely through the use of more efficient motors. However, improvements will also be introduced, by using the impellers which are best suited to each case, and through new, more highly optimised designs.

As from each phase, products which do not comply with the stated requirement may not be sold and marketed in the European market.

Are there any exceptions regarding the fans affected?

Yes, at least for the category of fans included in LOT11, and apart from the products which may be regulated in the future in other categories which have not yet been finalised. The current regulations, (EU) 327/2011, corresponding to LOT11 already contemplate exceptions such as:

- ATEX fans for explosive atmospheres.
- Fans which are exclusively for emergency use (400°C/2h, 300°C/1h, etc...)
- Fans which are specifically for working in environments at over 65°C, or for transporting gases at over 100°C.
- Fans specifically for working in environments of gases transported at temperatures of below -40°C.
- Fans with motors at special voltages Vac>1000V or Vdc>1500V.
- Fans for toxic, highly corrosive or inflammable environments.
- Fans used for transporting non-gaseous substances (solids) in industrial processes.

The possibility of being able to market fans which do not fulfil 327/2011 up to 1st January 2015 is also contemplated if they are intended to replace fans that are built into products marketed before 1st January 2013.

And what about products exported to countries outside the EU?

The directive is only required to be fulfilled within the EU.

Must efficient fans be marked?

Yes, because otherwise the breach of this directive would prevent CE marking. It should be clearly specified which products fulfil the requirements both in catalogues and in the selection programmes used.

Will these fans be more expensive?

Many of Sodeca's fans already satisfy the requirements of the directive. But in those cases in which the purchase price is significantly higher, the energy saving itself will allow you to recover your investment. And they are clearly much more economical in the long term. Sodeca is incorporating the latest new technology into high-efficiency IE2 and IE3 motors and EC systems with which many other advantages of regulation, communication and interaction with other pieces of equipment are going to be available.

How do you calculate the efficiency objective?

Regulation CE no. 327/2011 sets minimum efficiency requirements in two phases, the first one is applicable in 2013 and the second, more demanding one, in 2015. The efficiency objectives are determined according to the type of fan, the electrical power consumed at the point of maximum efficiency of the fan and the aerodynamic test type used. The degree of efficiency (N) is the value which takes the required efficiency for an input electrical power of 10 kW. N is different according to the type of test used and increases as it passes from the first to the second phase of application. For example, in an axial fan tested with a type C test, the value of N demanded for 2013 is 36% and for 2015 40%, as can be seen in the following graph.

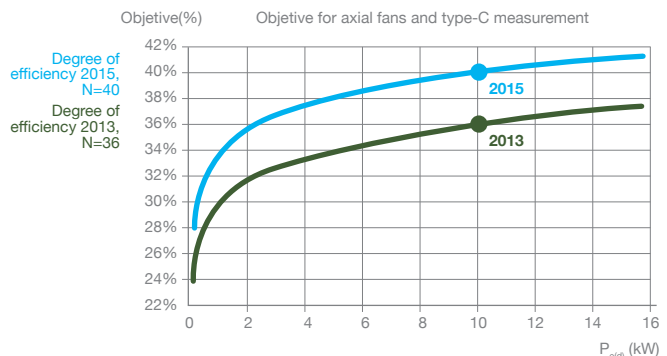

How do you calculate the efficiency of the fan?

The performance of the fan is calculated at the point of optimum efficiency. This must be equal to or greater than the objective required. The method of calculation is different according to the elements which the fan includes and whether it is at final assembly or not.

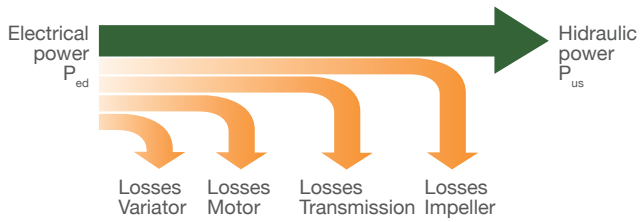

IF THE FAN IS SUPPLIED COMPLETE

a. If it does not have a speed inverter:

$$\eta_e = \frac{P_{u(s)}}{P_e}$$

b. If it has a speed inverter:

$$\eta_e = \frac{P_{u(s)}}{P_{ed}} \cdot C_c$$

Where, for the point of optimum efficiency:

- η_e is the global efficiency.
- $P_{u(s)}$ is the gas power of the fan.
- P_e is the input electrical power for the supply.
- P_{ed} is the input electrical power for the speed variator supply.
- C_c is the compensation factor of the partial load. For P_{ed} of more than 5 kW it is 1.04. For lower powers than 5 kW the factor is greater. See attached graph.

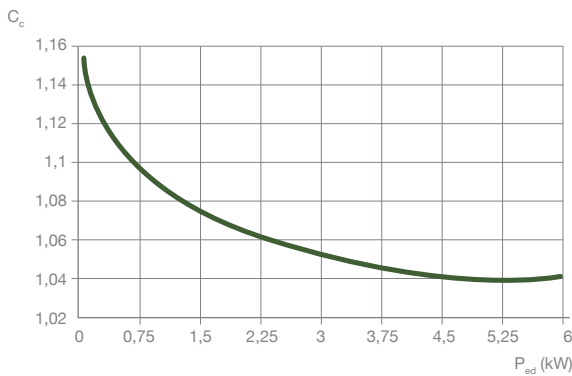

IF THE FAN IS SUPPLIED FOR ASSEMBLY

$$\eta_e = \eta_r \cdot \eta_m \cdot \eta_T \cdot C_m \cdot C_c$$

Where, for the point of optimum efficiency:

$$\eta_r = \frac{P_{u(s)}}{P_a}$$

- η_e is the global efficiency.
- η_r is the efficiency of the turbine, Where $P_{u(s)}$ is the gas power and P_a the mechanical power at the axis of the turbine.
- η_m is the efficiency of the motor. It is necessary to use motors which satisfy Regulation (CE) no. 640/2009 on motor efficiency. If the fan is supplied without motor or this is not covered by the by the motor regulations, it is possible to estimate its performance by calculation, according to the electrical input power recommended (P_e (kW)) for the point of optimum energy efficiency of the fan. In the following graphs, it is possible to observe these values by default.
- η_T is the efficiency of the transmission system. For fans with direct transmission, it is equal to 1. The transmission is considered to be of high efficiency when the width of the belt is equal to or greater than three times its height. Toothed belts and spur gears are also of high efficiency. Their performance can be estimated from the power of the axis of the turbine (P_a (kW)). For values of P_a of less than 1 kW and more than 5 kW, it is considered to be constant. See attached graph.
- C_m is the compensation factor to bear in mind the adaptation of the components. It is 0.9.
- C_c is the compensation factor of the partial load. In the case of there is no speed regulator, it is 1. If there is a variator, it takes the same values as the fan at final assembly.

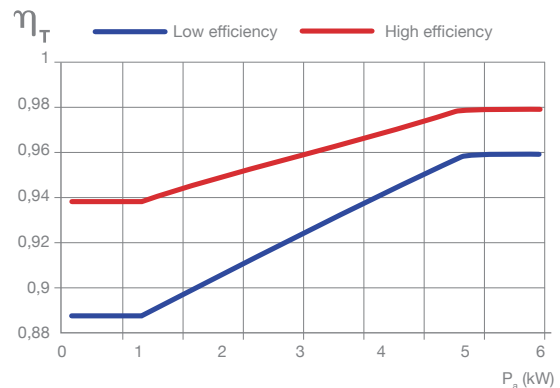
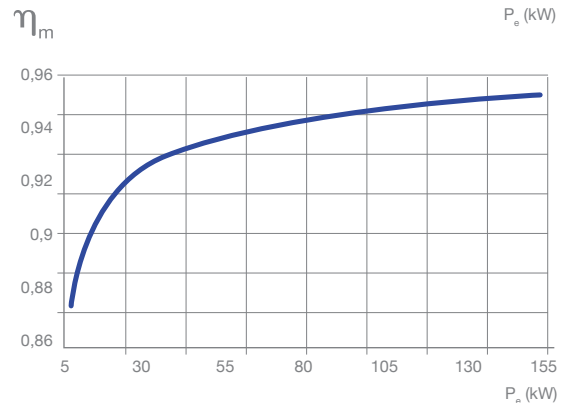
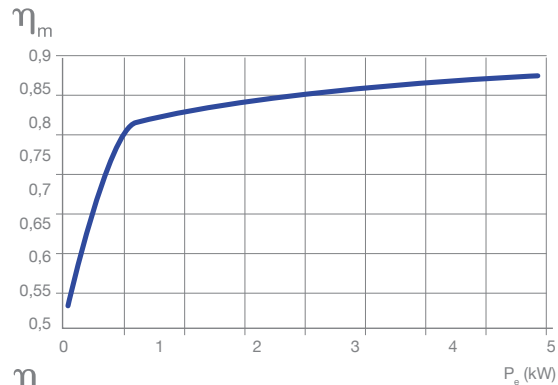

EFFICIENT WORK FANS



SOLution DEVELOPMENT CAPACITY

Fast and flexible industrial fan solutions and tailored fans
Large experience in smoke control systems and ATEX applications
Wide range of certified products for specific markets

AXIAL
AND
ROOF FANS



CENTRIFUGAL
FANS AND IN-LINE EXTRACTORS



FANS FOR
SMOKE
EXTRACTION



ATEX FANS FOR EXPLOSIVE
ATMOSPHERES AND OTHER
APPLICATIONS



HEAT RECOVERY
SYSTEMS AND
FILTRATION UNITS



AIR CURTAINS FOR
COMMERCIAL AND
INDUSTRIAL APPLICATIONS



VENTILATION SYSTEMS
FOR
HOUSES



REQUEST FURTHER INFORMATION

www.sodeca.com



Distributed by:



SODECA. HEADQUARTERS
Ctra. de Berga. km 0,7
E-08580 SANT QUIRZE
DE BESORA
Barcelona - SPAIN
Tel. +34 93 852 91 11
Fax +34 93 852 90 42
ventilation@sodeca.com

PORTUGAL
Sodeca Portugal Lda
Luiz Araújo
Rua Veloso Salgado 1120/1138
4450-801 Leça de Palmeira.
Oporto. PORTUGAL
Tel. +351 229 991 100
Fax. +351 229 991 119
geral@decflex.com

PORTUGAL
Sodeca Portugal Lda
Luiz Araújo
P. E. da Granja - Pavilhão 8
2625-607 Vialonga.
Lisboa. PORTUGAL
Tel. +351 219 748 491
Fax. +351 219 748 493
filial@decflex.com

FINLAND
Sodeca Finland Oy
Mr. Kai Yli-Sipila
Metsälinnankatu 30, PL2.
FI-32700 Huitinen.
FINLAND
Tel. +358 400 320 125
orders.finland@sodeca.com

CHILE
Sodeca Ventiladores Ltda
Sr. Francesc Bertran
Avda. Puerta Sur
03380 San Bernardo.
Santiago. CHILE
Tel. +56 22 840 5582
ventas.chile@sodeca.com

ÁREA CARIBE
Residencial Miramar
Apto. N° 108
Ave. 7ma N° 1805 entre 18 y 20
Miramar Playa.
Ciudad de la Habana. CUBA
Tel. 00537 20 43721
sodeca@sodeca.co.cu



Ctra. de Berga, km 0.7
 E-08580 SANT QUIRZE DE BESORA
 (Barcelona - Spain)
 Tel. +34 93 852 91 11
 Fax +34 93 852 90 42
 comercial@sodeca.com
 Export sales: ventilation@sodeca.com
 www.sodeca.com



PORTUGAL

Sodeca Portugal Lda
 Luiz Araújo
 Rua Veloso Salgado 1120/1138
 4450-801 Leça de Palmeira.
 Oporto. PORTUGAL
 Tel. +351 229 991 100
 Fax. +351 229 991 119
 geral@decflex.com

PORTUGAL

Sodeca Portugal Lda
 Luiz Araújo
 P. E. da Granja - Pavilhão 8
 2625-607 Vialonga.
 Lisboa. PORTUGAL
 Tel. +351 219 748 491
 Fax. +351 219 748 493
 filial@decflex.com

FINLAND

Sodeca Finland Oy
 Mr. Kai Yli-Sipila
 Metsälinnankatu 30. PL2.
 FI-32700 Huittinen.
 FINLAND
 Tel. + 358 400 320 125
 orders.finland@sodeca.com

CHILE

Sodeca Ventiladores Ltda
 Sr. Francesc Bertran
 Avda. Puerta Sur
 03380 San Bernardo.
 Santiago. CHILE
 Tel. +56 22 840 5582
 ventas.chile@sodeca.com

ÁREA CARIBE

Residencial Miramar
 Apto. N° 108
 Ave. 7ma N° 1805 entre 18 y 20
 Miramar Playa.
 Ciudad de la Habana. CUBA
 Tel. 00537 20 43721
 sodeca@sodeca.co.cu



Ctra. de Berga. km 0.7
E-08580 SANT QUIRZE DE BESORA
(Barcelona - Spain)
Tel. +34 93 852 91 11
Fax +34 93 852 90 42
comercial@sodeca.com
Export sales: ventilation@sodeca.com

www.sodeca.com

