

CLIPSAL[®]



REXTON[®]

Electrifying lifestyle !

CABLE MANAGEMENT
PVC & METAL



“Safe & Reliable”





CORPORATE HEAD QUARTERS, SHARJAH, UAE



CONTENTS

REXTON PVC CONDUITS AND ACCESSORIES

Certificates of Quality	6-7
Product Features	8
Rigid PVC Conduits	9
Rigid Socketed Conduits	10
Terminal Boxes	11
Loop in Boxes-Round	12
Junction Box Lids-Round	12
PVC Surface Boxes-Square & Rectangular	12
Junction Box Lids-Square & Rectangular	12
Flush Boxes, Adaptable Boxes	13
Plain Couplings, Expansion Couplings	14
Female Adaptors	14
Lock ring, Lock nut, Male bush, Bends	15
Inspection Bends / Elbow / Tee, Spacers	16
Saddles-Strap Saddles / Spacer Bar Saddles	17
Mounting Clip	17
Halogen Free Conduits & Accessories.....	18-25
PVC Jointing Cement, Bending Spring.....	26
Flexible Conduits	27
Glands-Straight Gland, Elbow Gland, Flange	28-29
PVC Trunking & Accessories.....	30-37
Draw Wire	38
Dry Lining Boxes	39
GI Switch Boxes & Adaptable Boxes	40-41
Raised Floor Boxes	42
Under Floor Boxes	43
Product Safety Data Sheet	44
Technical information	45-47

PVC CONDUITS & FITTINGS FACTORY, SAIF ZONE, SHARJAH-UAE





ISO 9001:2008



ISO 14001:2004



OHSAS 18001:2007



BSI Approval

bsi.		Test Report	
Report No	2381/7984834 Issue 2	This Report consists of 8 pages	
Client	Rexton Technologies Middle East FZE Executive Suite R1-36 P.O. Box 8080 Saif Zone Sharjah United Arab Emirates		
Authority & date	BSI Quotation Acceptance Form BSI 0000443188 Dated 26 March 2013 Equipment Record Number 10141414		
Items tested	Plastics Conduits		
Specification	BS EN 61386-21:2004 (BS EN 51386-1:2008) Clauses 6, 7, 8.1, 9.1, 10.2, 10.3, 10.4, 10.6, 11.3, 12.2 and 13.1.3 Independent test Issue 2 of this report supersedes all previous issues. The amendments on page 2 giving rise to this issue can be ascertained by contacting the authorising signatory.		
Results	See Summary of Results on page 2		
Prepared by	D Mackie <i>[Signature]</i>	Senior Engineer	
Authorized by	G R Essam <i>[Signature]</i>	Principal Engineer	
Issue Date	05 August 2013		
Conditions of issue	 <p>This Test Report is issued subject to the conditions stated in current issue of CPD222 'Conditions of Contract for Testing'. The issuing of this Test Report does not indicate any measure of Approval, Certification, Supervision, Control or Surveillance by BSI of any product. No extract, abridgement or distortion from a Test Report may be published or used to advertise a product without the written consent of the Managing Director, BSI Testing Services, who reserves the absolute right to agree or reject all or any of the details of any items or publicity for which consent may be sought. Test Results contained herein have assessments made on selected sample/s tested against the Product Standard and associated clauses as detailed on page 1 and 2 of this Test Report. Further information can be made available from the authorising signatory.</p>		
<p>BSI, Marylands Avenue, Hemel Hempstead, Hertfordshire, HP2 4SQ, Telephone: 08450 809000</p> <p>...making excellence a habit™</p>			



Corrugated Conduit

- Designed to BS 4607
- Available in Grey/Black/White
- Impact resistant UV stabilised PVC
- Reduces installation time
- Capable of being tightly coiled without damage
- Minimum bending radius - 1.5 times diameter

Rigid PVC Conduit

- Designed to BS 4607, BS EN 50086
- Designed to IEC 61386 where applicable
- Glueing capabilities for permanent joints
- Impact resistant UV stabilised PVC
- Available in Black, White & Grey*
- ROHS compliance to 2002/95/EC (Lead free product)*
- Made from recyclable PVC

Flame Retardant PVC Conduit

- Designed to IEC 61386 & ASTM D 2863
- Oxygen Index > 29%
- Temperature Index > 250°C

Round Junction Boxes

- Designed to BS 4607, BS EN 50086
- Designed to IEC 61386 where applicable
- Impact resistant UV stabilised PVC
- Dimensions : Outside Diameter 66mm
 Depth 32mm
 Lid Fixing centres 50mmxM4
- Provision for brass earth terminal
- Made from recyclable PVC
- Available in Black & White

Conduit Fittings

- Designed to BS 4607 where relevant
- Impact resistant UV stabilised PVC
- Made from recyclable PVC
- Available in Black, White & Grey*

Socketed PVC Conduits

- Designed to BS 4607, BS EN 50086
- Designed to IEC 61386 where applicable
- Available in White & Grey*
- Impact resistant UV Stabilised PVC
- Belled ends for easy jointing

*Available on request



RIGID CONDUIT - HEAVY

Material: PVC		Temperature: -5°/+60°C		
Description	Black	White	Pack	
20 / 1.8mm RIGID PVC CONDUIT - HEAVY GAUGE	RXT-9020HD/BK	RXT-9020HD/WE	20	
25 / 1.9mm RIGID PVC CONDUIT - HEAVY GAUGE	RXT-9025HD/BK	RXT-9025HD/WE	20	
32 / 2.5mm RIGID PVC CONDUIT - HEAVY GAUGE	RXT-9032HD/BK	RXT-9032HD/WE	10	
38 / 2.5mm RIGID PVC CONDUIT - HEAVY GAUGE	RXT-9038HD/BK	RXT-9038HD/WE	10	
50 / 3.2mm RIGID PVC CONDUIT - HEAVY GAUGE	RXT-9050HD/BK	RXT-9050HD/WE	5	



RIGID CONDUIT - MEDIUM

Material: PVC		Temperature: -5°/+60°C		
Description	Black	White	Pack	
20 / 1.6mm RIGID PVC CONDUIT - MEDIUM GAUGE	RXT-9020MD/BK	RXT-9020MD/WE	20	
25 / 1.8mm RIGID PVC CONDUIT - MEDIUM GAUGE	RXT-9025MD/BK	RXT-9025MD/WE	20	
32 / 2.1mm RIGID PVC CONDUIT - MEDIUM GAUGE	RXT-9032MD/BK	RXT-9032MD/WE	10	
38 / 2.2mm RIGID PVC CONDUIT - MEDIUM GAUGE	RXT-9038MD/BK	RXT-9038MD/WE	10	
50 / 2.5mm RIGID PVC CONDUIT - MEDIUM GAUGE	RXT-9050MD/BK	RXT-9050MD/WE	5	



RIGID CONDUIT - LIGHT

Material: PVC		Temperature: -5°/+60°C		
Description	Black	White	Pack	
20 / 1.2mm RIGID PVC CONDUIT - LIGHT GAUGE	RXT-9020LD/BK	RXT-9020LD/WE	20	
25 / 1.4mm RIGID PVC CONDUIT - LIGHT GAUGE	RXT-9025LD/BK	RXT-9025LD/WE	20	
32 / 1.5mm RIGID PVC CONDUIT - LIGHT GAUGE	RXT-9032LD/BK	RXT-9032LD/WE	10	
38 / 1.5mm RIGID PVC CONDUIT - LIGHT GAUGE	RXT-9038LD/BK	RXT-9038LD/WE	10	
50 / 1.9mm RIGID PVC CONDUIT - LIGHT GAUGE	RXT-9050LD/BK	RXT-9050LD/WE	5	

- Standard Length 2.9mtr
- Alternative Lengths can be supplied to order.

CONDUIT SPECIFICATIONS

Nominal Size	20LD	20MD	20HD	25LD	25MD	25HD	32LD	32MD	32HD	38LD	38MD	38HD	50LD	50MD	50HD
Outside Diameter(Nominal)	20.00	20.00	20.00	25.00	25.00	25.00	32.00	32.00	32.00	38.00	38.00	38.00	50.00	50.00	50.00
Wall Thickness(Nominal)	1.20	1.60	1.80	1.40	1.80	1.90	1.50	2.10	2.50	1.50	2.20	2.50	1.90	2.50	3.20
Min. Inside Diameter	17.15	16.35	15.95	21.75	20.95	20.65	28.55	27.35	26.55	34.55	33.15	32.55	45.75	44.45	43.15
Std. Packs(PCS)	20	20	20	20	20	20	10	10	10	10	10	10	5	5	5

*All dimensions in mm

RIGID SOCKETED CONDUIT - HEAVY



Material: PVC		Temperature: -5°/+60°C		
Description	Black	White	Pack	
20 / 1.8mm RIGID SOCKETED CONDUIT - HEAVY GAUGE	RXT-9020HD-S/BK	RXT-9020HD-S/WE	20	
25 / 1.9mm RIGID SOCKETED CONDUIT - HEAVY GAUGE	RXT-9025HD-S/BK	RXT-9025HD-S/WE	20	
32 / 2.5mm RIGID SOCKETED CONDUIT - HEAVY GAUGE	RXT-9032HD-S/BK	RXT-9032HD-S/WE	10	
38 / 2.5mm RIGID SOCKETED CONDUIT - HEAVY GAUGE	RXT-9038HD-S/BK	RXT-9038HD-S/WE	10	
50 / 3.2mm RIGID SOCKETED CONDUIT - HEAVY GAUGE	RXT-9050HD-S/BK	RXT-9050HD-S/WE	5	

RIGID SOCKETED CONDUIT - MEDIUM



Material: PVC		Temperature: -5°/+60°C		
Description	Black	White	Pack	
20 / 1.6mm RIGID SOCKETED CONDUIT - MEDIUM GAUGE	RXT-9020MD-S/BK	RXT-9020MD-S/WE	20	
25 / 1.8mm RIGID SOCKETED CONDUIT - MEDIUM GAUGE	RXT-9025MD-S/BK	RXT-9025MD-S/WE	20	
32 / 2.1mm RIGID SOCKETED CONDUIT - MEDIUM GAUGE	RXT-9032MD-S/BK	RXT-9032MD-S/WE	10	
38 / 2.2mm RIGID SOCKETED CONDUIT - MEDIUM GAUGE	RXT-9038MD-S/BK	RXT-9038MD-S/WE	10	
50 / 2.5mm RIGID SOCKETED CONDUIT - MEDIUM GAUGE	RXT-9050MD-S/BK	RXT-9050MD-S/WE	5	

RIGID SOCKETED CONDUIT - LIGHT



Material: PVC		Temperature: -5°/+60°C		
Description	Black	White	Pack	
20 / 1.2mm RIGID SOCKETED CONDUIT - LIGHT GAUGE	RXT-9020LD-S/BK	RXT-9020LD-S/WE	20	
25 / 1.4mm RIGID SOCKETED CONDUIT - LIGHT GAUGE	RXT-9025LD-S/BK	RXT-9025LD-S/WE	20	
32 / 1.5mm RIGID SOCKETED CONDUIT - LIGHT GAUGE	RXT-9032LD-S/BK	RXT-9032LD-S/WE	10	
38 / 1.5mm RIGID SOCKETED CONDUIT - LIGHT GAUGE	RXT-9038LD-S/BK	RXT-9038LD-S/WE	10	
50 / 1.9mm RIGID SOCKETED CONDUIT - LIGHT GAUGE	RXT-9050LD-S/BK	RXT-9050LD-S/WE	5	

- Standard Length 2.9mtr
- Alternative Lengths can be supplied to order.



TERMINAL BOXES



Material: PVC		Temperature: -5°/+60°C		
Description	Black	White	Pack	
20mm TERMINAL ONE WAY	RXT-E240/20/1/BK	RXT-E240/20/1/WE	25	
25mm TERMINAL ONE WAY	RXT-E240/25/1/BK	RXT-E240/25/1/WE	25	
20mm THROUGH TWO WAY	RXT-E240/20/2/BK	RXT-E240/20/2/WE	20	
25mm THROUGH TWO WAY	RXT-E240/25/2/BK	RXT-E240/25/2/WE	20	
20mm ANGLE TWO WAY	RXT-E240/20/2A/BK	RXT-E240/20/2A/WE	20	
25mm ANGLE TWO WAY	RXT-E240/25/2A/BK	RXT-E240/25/2A/WE	20	
20mm TEE THREE WAY	RXT-E240/20/3/BK	RXT-E240/20/3/WE	20	
25mm TEE THREE WAY	RXT-E240/25/3/BK	RXT-E240/25/3/WE	20	
20mm INTERSECTION FOUR WAY	RXT-E240/20/4/BK	RXT-E240/20/4/WE	20	
25mm INTERSECTION FOUR WAY	RXT-E240/25/4/BK	RXT-E240/25/4/WE	20	
20mm U - TWO WAY	RXT-E240/20/U/BK	RXT-E240/20/U/WE	20	
25mm U - TWO WAY	RXT-E240/25/U/BK	RXT-E240/25/U/WE	20	
20mm Y - THREE WAY	RXT-E240/20/Y/BK	RXT-E240/20/Y/WE	20	
25mm Y - THREE WAY	RXT-E240/25/Y/BK	RXT-E240/25/Y/WE	20	
20mm H - FOUR WAY	RXT-E240/20/H/BK	RXT-E240/20/H/WE	20	
25mm H - FOUR WAY	RXT-E240/25/H/BK	RXT-E240/25/H/WE	20	
20mm D - ONE WAY	RXT-E240/20/ID/BK	RXT-E240/20/ID/WE	20	
25mm D - ONE WAY	RXT-E240/25/ID/BK	RXT-E240/25/ID/WE	20	
20mm AD - TWO WAY	RXT-E240/20/AD/BK	RXT-E240/20/2AD/WE	20	
25mm AD - TWO WAY	RXT-E240/25/AD/BK	RXT-E240/25/2AD/WE	20	

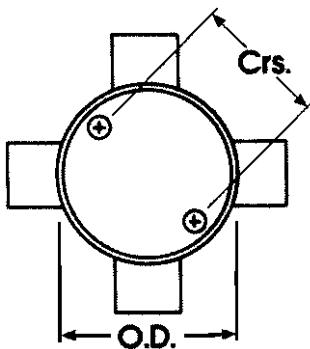

240 Series

Diameter (O.D.)	DEPTH	Screw Centres (Crs.)
66mm	32mm	50mmXM4 Brass inserts

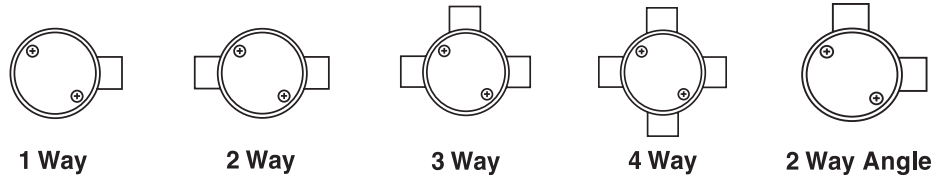

Circular boxes

PVC-U plain bored circular boxes are suitable for suspending loads of up to 3kg centrally at 60°C maximum. Fixing centres are at 50.8mm and fitted with M4 brass inserts.



LOOP IN BOXES - ROUND

Material: PVC		Temperature: -5°/+60°C		
Description	Black	White	Pack	
20mm LOOP IN BOX	RXT-E240/20L/BK	RXT-E240/20L/WE	25	
25mm LOOP IN BOX	RXT-E240/25L/BK	RXT-E240/25L/WE	25	



JUNCTION BOX LIDS - ROUND

Material: PVC		Temperature: -5°/+60°C		
Description	Black	White	Pack	
66mm LID ROUND	RXT-E240/L/BK	RXT-E240/L/WE	100	
85mm LID ROUND	RXT-E240L-I-BK	RXT-E240L-I-WE	100	

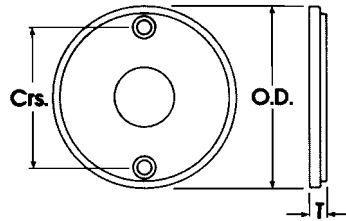

Replacement Lids are available for 240 Series Junction Boxes.

Outside Diameter (O.D.)	Centres (Crs.)
66mm	50mm
85mm	50mm



PVC SURFACE BOX- SQUARE & RECTANGLE

Material: PVC		Temperature: -5°/+60°C	
Description	White	Pack	
PVC BOX 3X3 - SURFACE (87X87mm)	RXT-1211LD	20	
PVC BOX 6X3 - SURFACE (87X147mm)	RXT-1212LD	10	
PVC BOX 3x3 FLUSH MOUNT WITH ADJUSTABLE LUG (87X87mm)	RXT-1211FLD	20	
PVC BOX 3x6 FLUSH MOUNT WITH ADJUSTABLE LUG (87x147mm)	RXT-1212FLD	10	



JUNCTION BOX LIDS-SQUARE & RECTANGLE

Material: PVC		Temperature: -5°/+60°C		
Description	Black	White	Pack	
LID SQUARE	RXT-E240/L/SQ/BK	RXT-E240/L/SQ/WE	100	
LID RECTANGLE	RXT-E240/L/RL/BK	RXT-E240/L/RL/WE	100	

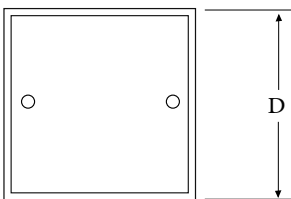

Dimension (D)
3x3
6x3



FLUSH BOXES

Material: PVC		Temperature: -5°/+60°C	
Description	Black	White	
75x75x35mm FLUSH BOX	RXT HFSB 1/BK	RXT HFSB 1/WE	
135x75x35mm FLUSH BOX	RXT HFSB 2/BK	RXT HFSB 2/WE	



ADAPTABLE BOXES

Material: PVC		Temperature: -5°/+60°C		
Description	Black	White	Pack	
100x100x75mm ADAPTABLE BOX	RXT-E265/2D/BK	RXT-E265/2D/WE	75	
150x150x75mm ADAPTABLE BOX	RXT-E265/3D/BK	RXT-E265/3D/WE	34	
225x225x75mm ADAPTABLE BOX	RXT-E265/4/BK	RXT-E265/4/WE	13	



ADAPTABLE BOXES WITH IP 65 RATING, WATER PROOF

Description	Code	Pack
80x80x40 mm BOX WITH SLEEVE	RABSIP/80/80/40/W	200
100x100x50 mm BOX WITH SLEEVE	RABSIP/100/100/50/W	114
150x110x70 mm BOX WITH SLEEVE	RABSIP/150/110/70/W	50
150x150x70 mm BOX WITH SLEEVE	RABSIP/150/150/70/W	40
190x140x70 mm BOX WITH SLEEVE	RABSIP/190/140/70/W	20
240x190x90 mm BOX WITH SLEEVE	RABSIP/240/190/90/W	15
300x220x120 mm BOX WITH SLEEVE	RABSIP/300/220/120/W	10
380x300x120 mm BOX WITH SLEEVE	RABSIP/380/300/120/W	5



ADAPTABLE BOXES WITH IP 65 RATING, WATER PROOF

Description	Code	Pack
100x100x50 mm BOX WITHOUT SLEEVE	RABIP/100/100/50/W	126
150x110x70 mm BOX WITHOUT SLEEVE	RABIP/150/110/70/W	60
150x150x70 mm BOX WITHOUT SLEEVE	RABIP/150/150/70/W	40
190x140x70 mm BOX WITHOUT SLEEVE	RABIP/190/140/70/W	39
240x190x90 mm BOX WITHOUT SLEEVE	RABIP/240/190/90/W	20
300x220x120 mm BOX WITHOUT SLEEVE	RABIP/300/220/120/W	8
380x300x120 mm BOX WITHOUT SLEEVE	RABIP/380/300/120/W	5



PLAIN COUPLINGS

Material: PVC		Temperature: -5°/+60°C		
Description	Black	White	Pack	
20mm COUPLINGS	RXT-E242/20/BK	RXT-E242/20/WE	100	
25mm COUPLINGS	RXT-E242/25/BK	RXT-E242/25/WE	50	
32mm COUPLINGS	RXT-E242/32/BK	RXT-E242/32/WE	50	
38mm COUPLINGS	RXT-E242/38/BK	RXT-E242/38/WE	25	
50mm COUPLINGS	RXT-E242/50/BK	RXT-E242/50/WE	15	

Plain Couplings allow joining of two lengths of conduit of the same size.

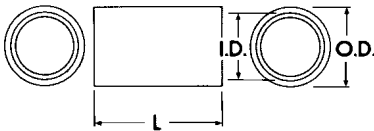

242 Series

Size	Inside Diameter(I.D)	Outside Diameter(O.D)	Length(L)
20mm	20mm	25mm	42mm
25mm	25mm	30mm	42mm
32mm	32mm	37mm	52mm
38mm	38mm	42.6mm	79.2mm
50mm	50mm	57mm	80mm

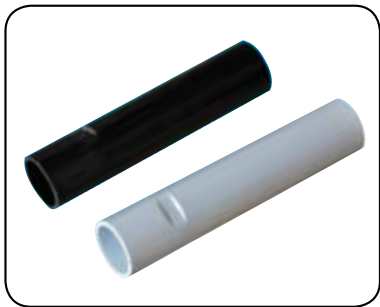

EXPANSION COUPLINGS

Material: PVC		Temperature: -5°/+60°C		
Description	Black	White	Pack	
20mm EXPANSION COUPLING	RXT-E251/20/BK	RXT-E251/20/WE	750	
25mm EXPANSION COUPLING	RXT-E251/25/BK	RXT-E251/25/WE	525	
32mm EXPANSION COUPLING	RXT-E251/32/BK	RXT-E251/32/WE	120	
38mm EXPANSION COUPLING	RXT-E251/38/BK	RXT-E251/38/WE	100	
50mm EXPANSION COUPLING	RXT-E251/50/BK	RXT-E251/50/WE	50	

Where long conduit runs are likely to be exposed to wide variations in temperature, it is recommended that expansion couplings be used at each joint. Flexible Expansion Couplings are available from 20mm to 50mm.

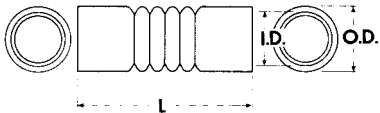

251 Series

Size	Inside Diameter(I.D)	Outside Diameter(O.D)	Length(L)
20mm	20mm	23.40	109mm
25mm	31mm	28.80	110mm
32mm	32mm	36.30	125mm
38mm	38mm	42.10	148mm
50mm	50mm	54.60	166mm



FEMALE ADAPTORS

Material: PVC		Temperature: -5°/+60°C		
Description	Black	White	Pack	
20mm FEMALE ADAPTORS WITH MALE BUSH	RXT-E258/20/BK	RXT-E258/20/WE	100	
25mm FEMALE ADAPTORS WITH MALE BUSH	RXT-E258/25/BK	RXT-E258/25/WE	50	
32mm FEMALE ADAPTORS WITH MALE BUSH	RXT-E258/32/BK	RXT-E258/32/WE	50	
38mm FEMALE ADAPTORS WITH MALE BUSH	RXT-E258/38/BK	RXT-E258/38/WE	25	
50mm FEMALE ADAPTORS WITH MALE BUSH	RXT-E258/50/BK	RXT-E258/50/WE	20	

258 Series



LOCK RING

Black (RAL 9005) or White (RAL 9010)

Material: PVC	Temperature: -5°/+60°C	
Description	Black	White
20mm LOCK RING	RXT-LR 20/BK	RXT-LR 20/WE
25mm LOCK RING	RXT-LR 25/BK	RXT-LR 25/WE



LOCK NUT

Black (RAL 9005) or White (RAL 9010)

Material: PVC	Temperature: -5°/+60°C	
Description	Black	White
16mm LOCK NUT	RXT-LN 16/BK	RXT-RL 16/WE
20mm LOCK NUT	RXT-LN 20/BK	RXT-RL 20/WE
25mm LOCK NUT	RXT-LN 25/BK	RXT-RL 25/WE
32mm LOCK NUT	RXT-LN 32/BK	RXT-RL 32/WE
40mm LOCK NUT	RXT-LN 40/BK	RXT-RL 40/WE
50mm LOCK NUT	RXT-LN 50/BK	RXT-RL 50/WE



MALE BUSH

Black (RAL 9005) or White (RAL 9010)

Material: PVC	Temperature: -5°/+60°C	
Description	Black	White
16mm MALE BUSH	RXT-MBS 16/BK	RXT-MBS 16/WE
20mm MALE BUSH	RXT-MBS 20/BK	RXT-MBS 20/WE
25mm MALE BUSH	RXT-MBS 25/BK	RXT-MBS 25/WE
32mm MALE BUSH	RXT-MBS 32/BK	RXT-MBS 32/WE
40mm MALE BUSH	RXT-MBS 40/BK	RXT-MBS 40/WE
50mm MALE BUSH	RXT-MBS 50/BK	RXT-MBS 50/WE



BENDS

Material: PVC	Temperature: -5°/+60°C		
Description	Black	White	Pack
20mm BEND - HEAVY	RXT-E247/20/BK	RXT-E247/20/WE	600
25mm BEND - HEAVY	RXT-E247/25/BK	RXT-E247/25/WE	300
32mm BEND - HEAVY	RXT-E247/32/BK	RXT-E247/32/WE	120
38mm BEND - HEAVY	RXT-E247/38/BK	RXT-E247/38/WE	80
50mm BEND - HEAVY	RXT-E247/50/BK	RXT-E247/50/WE	35

Available in a range of sizes from 20mm to 50mm.

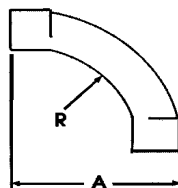
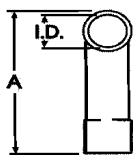

247 Series

Size	Inside Diameter(I.D)	Radius (R)	Bend Length(A)
20mm	20mm	52mm	110mm
25mm	25mm	82mm	160mm
32mm	32mm	112mm	225mm
38mm	38mm	142mm	260mm
50mm	50mm	170mm	325mm



INSPECTION BEND

Black (RAL 9005), for rigid conduits

Material: PVC	Temperature: -5°/+60°C	
Description	Black	White
20mm INSPECTION BEND	RXT-IB 20/BK	RXT-IB 20/WE
25mm INSPECTION BEND	RXT-IB 25/BK	RXT-IB25/WE



INSPECTION ELBOW

Black (RAL 9005), for rigid conduits

Material: PVC	Temperature: -5°/+60°C	
Description	Black	White
20mm INSPECTION ELBOW	RXT-IE 20/BK	RXT-IE 20/WE
25mm INSPECTION ELBOW	RXT-IE 25/BK	RXT-IE/25/WE



INSPECTION TEE

black (RAL 9005), for rigid conduits

Material: PVC	Temperature: -5°/+60°C	
Description	Black	White
20mm INSPECTION TEE	RXT-IT 20/BK	RXT-IT 20/WE
25mm INSPECTION TEE	RXT-IT 25/BK	RXT-IT/25/WE



SPACER

Material: PVC	Temperature: -5°/+60°C		
Description	Black	White	Pack
20mm SPACER	RXT-E261S20/BK	RXT-E261S20/WE	100
25mm SPACER	RXT-E261S25/BK	RXT-E261S25/WE	75
32mm SPACER	RXT-E261S32/BK	RXT-E261S32/WE	50
38mm SPACER	RXT-E261S38/BK	RXT-E261S38/WE	50
50mm SPACER	RXT-E261S50/BK	RXT-E261S50/WE	25

Saddles Spacers set a conduit run off the wall 8mm to allow easier cleaning and repainting and to facilitate entry into equipment. They are available in sizes 20mm to 50mm.

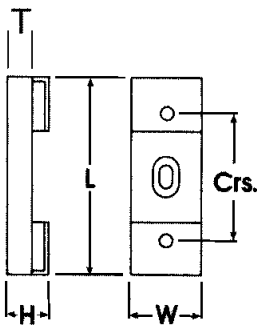

261S Series

Size	Length(L)	Width(W)	Centres(Crs)	Standoff(T)	Height(H)
20mm	61mm	22mm	40mm	8mm	14mm
25mm	74mm	26mm	48mm	8mm	14mm

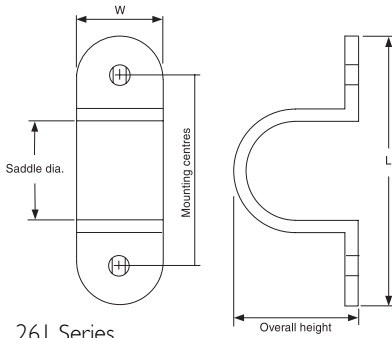

261 Series

STRAP SADDLES

Material: PVC		Temperature: -5°/+60°C		
Description	Black	White	Pack	
20mm STRAP SADDLES	RXT-E261/20/BK	RXT-E261/20/WE	100	
25mm STRAP SADDLES	RXT-E261/25/BK	RXT-E261/25/WE	75	
32mm STRAP SADDLES	RXT-E261/32/BK	RXT-E261/32/WE	50	
38mm STRAP SADDLES	RXT-E261/38/BK	RXT-E261/38/WE	25	
50mm STRAP SADDLES	RXT-E261/50/BK	RXT-E261/50/WE	25	

Where neatness and corrosion resistance are imperative, moulded saddles are often the best solution. The 261 Series is tough and UV resistant, and colour matched to the Rexton conduit product range.

Saddles Diameter	Length(L)	Width(W)	Overall Height	Mounting Centres
20mm	57mm	16mm	23mm	40mm
25mm	63mm	20mm	29mm	48mm
32mm	82mm	22mm	35mm	60mm
50mm	105mm	27mm	56mm	78mm



261S Series

SPACER BAR SADDLES

Material: PVC		Temperature: -5°/+60°C		
Description	Black	White	Pack	
20mm SPACER BAR SADDLES	RXT-E261S20A/BK	RXT-E261S20A/WE	100	
25mm SPACER BAR SADDLES	RXT-E261S25A/BK	RXT-E261S25A/WE	75	
32mm SPACER BAR SADDLES	RXT-E261S32A/BK	RXT-E261S32A/WE	50	
38mm SPACER BAR SADDLES	RXT-E261S38A/BK	RXT-E261S38A/WE	50	
50mm SPACER BAR SADDLES	RXT-E261S50A/BK	RXT-E261S50A/WE	25	

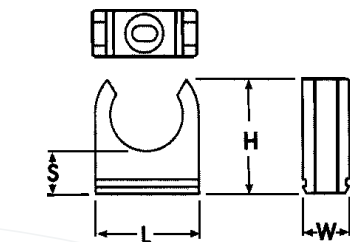

280 Series

MOUNTING CLIP

Material: PVC		Temperature: -5°/+60°C	
Description	Black	White	
20mm MOUNTING CLIP	RXT-E280/20/BK	RXT-E280/20/WE	
25mm MOUNTING CLIP	RXT-E280/25/BK	RXT-E280/25/WE	
32mm MOUNTING CLIP	RXT-E280/32/BK	RXT-E280/32/WE	
38mm MOUNTING CLIP	RXT-E280/38/BK	RXT-E280/38/WE	
50mm MOUNTING CLIP	RXT-E280/50/BK	RXT-E280/50/WE	

280 Series Conduit Clips are a clip in type conduit mount that can be mounted direct onto a wall or other surface, or slid into a 280MC Mounting Channel. They are available in sizes 16mm through to 50mm, and provide a standoff of between 9mm and 13mm.

Conduit Accommodated	Standoff(S)	Leight(L)	Height(H)	Width
20mm	11mm	27mm	29mm	12mm
25mm	13mm	34mm	36mm	12mm
32mm	9mm	41mm	38mm	12mm
50mm	13mm	62mm	54mm	12mm



CONDUITS & ACCESSORIES



RIGID CONDUITS - HEAVY



Material: PVC		Temperature: -5°/+60°C		
Description	Black	White	Pack	
20 / 1.8mm RIGID PVC CONDUIT - HEAVY GAUGE	RHFBS20HD/BK	RHFBS20HD/WE	20	
25 / 1.9mm RIGID PVC CONDUIT - HEAVY GAUGE	RHFBS25HD/BK	RHFBS25HD/WE	20	
32 / 2.5mm RIGID PVC CONDUIT - HEAVY GAUGE	RHFBS32HD/BK	RHFBS32HD/WE	10	
38 / 2.5mm RIGID PVC CONDUIT - HEAVY GAUGE	RHFBS38HD/BK	RHFBS38HD/WE	10	
50 / 3.2mm RIGID PVC CONDUIT - HEAVY GAUGE	RHFBS50HD/BK	RHFBS50HD/WE	5	



RIGID CONDUITS - MEDIUM



Material: PVC		Temperature: -5°/+60°C		
Description	Black	White	Pack	
20 / 1.6mm RIGID PVC CONDUIT - MEDIUM GAUGE	RHFPRM20MD/BK	RHFPRM20MD/WE	20	
25 / 1.8mm RIGID PVC CONDUIT - MEDIUM GAUGE	RHFPRM25MD/BK	RHFPRM25MD/WE	20	
32 / 2.1mm RIGID PVC CONDUIT - MEDIUM GAUGE	RHFPRM32MD/BK	RHFPRM32MD/WE	10	
38 / 2.2mm RIGID PVC CONDUIT - MEDIUM GAUGE	RHFPRM38MD/BK	RHFPRM38MD/WE	10	
50 / 2.5mm RIGID PVC CONDUIT - MEDIUM GAUGE	RHFPRM50MD/BK	RHFPRM50MD/WE	5	



RIGID CONDUITS - LIGHT



Material: PVC		Temperature: -5°/+60°C		
Description	Black	White	Pack	
20 / 1.2mm RIGID PVC CONDUIT - LIGHT GAUGE	RHFPRM20LD/BK	RHFPRM20LD/WE	20	
25 / 1.4mm RIGID PVC CONDUIT - LIGHT GAUGE	RHFPRM25LD/BK	RHFPRM25LD/WE	20	
32 / 1.5mm RIGID PVC CONDUIT - LIGHT GAUGE	RHFPRM32LD/BK	RHFPRM32LD/WE	10	
38 / 1.5mm RIGID PVC CONDUIT - LIGHT GAUGE	RHFPRM38LD/BK	RHFPRM38LD/WE	10	
50 / 1.9mm RIGID PVC CONDUIT - LIGHT GAUGE	RHFPRM50LD/BK	RHFPRM50LD/WE	5	

- Standard Length 2.9mtr
- Alternative Lengths can be supplied to order.



RIGID SOCKETED CONDUITS - HEAVY



Material: PVC		Temperature: -5°/+60°C		
Description	Black	White	Pack	
20 / 1.8mm RIGID SOCKETED CONDUIT- HEAVY GAUGE	RHF-9020HD-S/BK	RHF-9020HD-S/WE	20	
25 / 1.9mm RIGID SOCKETED CONDUIT- HEAVY GAUGE	RHF-9025HD-S/BK	RHF-9025HD-S/WE	20	
32 / 2.5mm RIGID SOCKETED CONDUIT- HEAVY GAUGE	RHF-9032HD-S/BK	RHF-9032HD-S/WE	10	
38 / 2.5mm RIGID SOCKETED CONDUIT- HEAVY GAUGE	RHF-9038HD-S/BK	RHF-9038HD-S/WE	10	
50 / 3.2mm RIGID SOCKETED CONDUIT- HEAVY GAUGE	RHF-9050HD-S/BK	RHF-9050HD-S/WE	5	



RIGID SOCKETED CONDUITS - MEDIUM



Material: PVC		Temperature: -5°/+60°C		
Description	Black	White	Pack	
20 / 1.6mm RIGID SOCKETED CONDUIT-MEDIUM GAUGE	RHF-9020MD-S/BK	RHF-9020MD-S/WE	20	
25 / 1.8mm RIGID SOCKETED CONDUIT-MEDIUM GAUGE	RHF-9025MD-S/BK	RHF-9025MD-S/WE	20	
32 / 2.1mm RIGID SOCKETED CONDUIT-MEDIUM GAUGE	RHF-9032MD-S/BK	RHF-9032MD-S/WE	10	
38 / 2.2mm RIGID SOCKETED CONDUIT-MEDIUM GAUGE	RHF-9038MD-S/BK	RHF-9038MD-S/WE	10	
50 / 2.5mm RIGID SOCKETED CONDUIT-MEDIUM GAUGE	RHF-9050MD-S/BK	RHF-9050MD-S/WE	5	



RIGID SOCKETED CONDUITS - LIGHT



Material: PVC		Temperature: -5°/+60°C		
Description	Black	White	Pack	
20 / 1.2mm RIGID SOCKETED CONDUIT - LIGHT GAUGE	RHF-9020LD-S/BK	RHF-9020LD-S/WE	20	
25 / 1.4mm RIGID SOCKETED CONDUIT - LIGHT GAUGE	RHF-9025LD-S/BK	RHF-9025LD-S/WE	20	
32 / 1.5mm RIGID SOCKETED CONDUIT - LIGHT GAUGE	RHF-9032LD-S/BK	RHF-9032LD-S/WE	10	
38 / 1.5mm RIGID SOCKETED CONDUIT - LIGHT GAUGE	RHF-9038LD-S/BK	RHF-9038LD-S/WE	10	
50 / 1.9mm RIGID SOCKETED CONDUIT - LIGHT GAUGE	RHF-9050LD-S/BK	RHF-9050LD-S/WE	5	

- Standard Length 2.9mtr
- Alternative Lengths can be supplied to order.



TERMINAL BOXES



Material: PVC		Temperature: -5°/+60°C		
Description	Black	White	Pack	
20mm TERMINAL ONE WAY	RHFCB20/1/BK	RHFCB20/1/WE	25	
25mm TERMINAL ONE WAY	RHFCB25/1/BK	RHFCB25/1/WE	25	
20mm THROUGH TWO WAY	RHFCB20/2/BK	RHFCB20/2/WE	20	
25mm THROUGH TWO WAY	RHFCB25/2/BK	RHFCB25/2/WE	20	
20mm ANGLE TWO WAY	RHFCB20/2A/BK	RHFCB20/2A/WE	20	
25mm ANGLE TWO WAY	RHFCB25/2A/BK	RHFCB25/2A/WE	20	
20mm TEE THREE WAY	RHFCB20/3/BK	RHFCB20/3/WE	20	
25mm TEE THREE WAY	RHFCB25/3/BK	RHFCB25/3/WE	20	
20mm INTERSECTION FOUR WAY	RHFCB20/4/BK	RHFCB20/4/WE	20	
25mm INTERSECTION FOUR WAY	RHFCB25/4/BK	RHFCB25/4/WE	20	
20mm U - TWO WAY	RHFCB20/U/BK	RHFCB20/U/WE	20	
25mm U - TWO WAY	RHFCB25/U/BK	RHFCB25/U/WE	20	
20mm Y - THREE WAY	RHFCB20/Y/BK	RHFCB20/Y/WE	20	
25mm Y - THREE WAY	RHFCB25/Y/BK	RHFCB25/Y/WE	20	
20mm H - FOUR WAY	RHFCB20/H/BK	RHFCB20/H/WE	20	
25mm H - FOUR WAY	RHFCB25/H/BK	RHFCB25/H/WE	20	
20mm D - ONE WAY	RHFCB20/D/BK	RHFCB20/D/WE	20	
25mm D - ONE WAY	RHFCB25/D/BK	RHFCB25/D/WE	20	
20mm AD - TWO WAY	RHFCB20/AD/BK	RHFCB20/2AD/WE	20	
25mm AD - TWO WAY	RHFCB25/AD/BK	RHFCB25/2AD/WE	20	

Diameter (O.D.)	DEPTH	Screw Centres (Crs.)
66mm	32mm	50mmXM4 Brass inserts

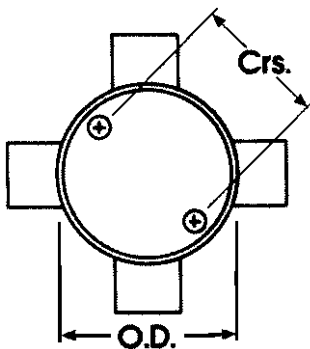

240 Series

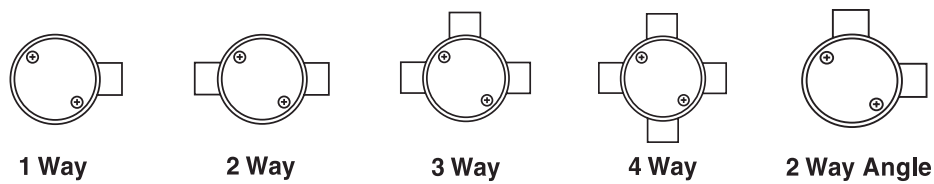

Circular boxes
 PVC-U plain bored circular boxes are suitable for suspending loads of up to 3kg centrally at 60°C maximum. Fixing centres are at 50.8mm and fitted with M4 brass inserts.



LOOP IN BOXES - ROUND



Material: PVC		Temperature: -5°/+60°C		
Description	Black	White	Pack	
20mm LOOP IN BOX	RLIB20L/BK	RLIB20L/WE	25	
25mm LOOP IN BOX	RLIB25L/BK	RLIB25L/WE	25	



JUNCTION BOX LIDS - ROUND



Material: PVC		Temperature: -5°/+60°C		
Description	Black	White	Pack	
66mm LID ROUND	RHFCBL66/BK	RHFCBL66/WE	100	
85mm LID ROUND	RHFCBL85/BK	RHFCBL85/WE	100	

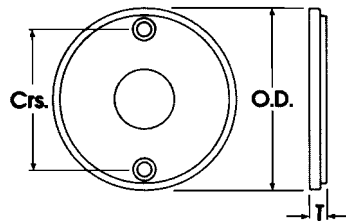

Replacement Lids are available for 240 Series Junction Boxes.

Outside Diameter (O.D.)	Centres (Crs.)
66mm	50mm
85mm	50mm



JUNCTION BOX LIDS-SQUARE & RECTANGLE



Material: PVC		Temperature: -5°/+60°C		
Description	Black	White	Pack	
LID SQUARE	RHFCBL/SQ/BK	RHFCBL/SQ/WE	100	
LID RECTANGLE	RHFCBL/RL/BK	RHFCBL/RL/WE	100	

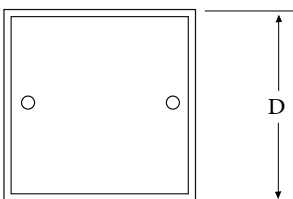

Dimension (D)
3x3
6x3



PVC SURFACE BOX- SQUARE & RECTANGLE



Material: PVC		Temperature: -5°/+60°C	
Description	White	Pack	
PVC BOX 3X3 - SURFACE (87X87mm)	RHF-1211LD	20	
PVC BOX 6X3 - SURFACE (87X147mm)	RHF-1212LD	10	
PVC BOX 3x3 FLUSH MOUNT WITH ADJUSTABLE LUG (87X87mm)	RHF-1211FLD	20	
PVC BOX 3x6 FLUSH MOUNT WITH ADJUSTABLE LUG (87x147mm)	RHF-1212FLD	10	



PLAIN COUPLINGS



Material: PVC		Temperature: -5°/+60°C		
Description	Black	White	Pack	
20mm COUPLING	RSM20/BK	RSM20/WE	100	
25mm COUPLING	RSM25/BK	RSM25/WE	50	
32mm COUPLING	RSM32/BK	RSM32/WE	50	
38mm COUPLING	RSM38/BK	RSM38/WE	25	
50mm COUPLING	RSM50/BK	RSM50/WE	15	

Plain Couplings allow joining of two lengths of conduit of the same size.

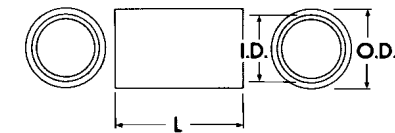

242 Series

Size	Inside Diameter(I.D)	Outside Diameter(O.D)	Length(L)
20mm	20mm	25mm	42mm
25mm	25mm	30mm	42mm
32mm	32mm	37mm	52mm
38mm	38mm	42.6mm	79.2mm
50mm	50mm	57mm	80mm

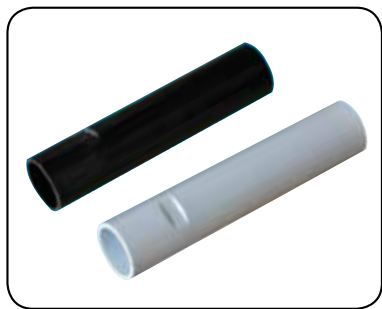

EXPANSION COUPLINGS



Material: PVC		Temperature: -5°/+60°C		
Description	Black	White	Pack	
20mm EXPANSION COUPLING	REC20/BK	REC20/WE	750	
25mm EXPANSION COUPLING	REC25/BK	REC25/WE	525	
32mm EXPANSION COUPLING	REC32/BK	REC32/WE	120	
38mm EXPANSION COUPLING	REC38/BK	REC38/WE	100	
50mm EXPANSION COUPLING	REC50/BK	REC50/WE	50	

Where long conduit runs are likely to be exposed to wide variations in temperature, it is recommended that expansion couplings be used at each joint. Flexible Expansion Couplings are available from 20mm to 50mm.

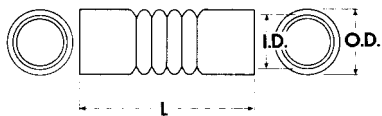

251 Series

Size	Inside Diameter(I.D)	Outside Diameter(O.D)	Length(L)
20mm	20mm	23.40	109mm
25mm	31mm	28.80	110mm
32mm	32mm	36.30	125mm
38mm	38mm	42.10	148mm
50mm	50mm	54.60	166mm



FEMALE ADAPTORS



Material: PVC		Temperature: -5°/+60°C		
Description	Black	White	Pack	
20mm FEMALE ADAPTOR WITH MALE BUSH	RHFAPT/MBS20/BK	RHFAPT/MBS20/WE	100	
25mm FEMALE ADAPTOR WITH MALE BUSH	RHFAPT/MBS25/BK	RHFAPT/MBS25/WE	50	
32mm FEMALE ADAPTOR WITH MALE BUSH	RHFAPT/MBS32/BK	RHFAPT/MBS32/WE	50	
38mm FEMALE ADAPTOR WITH MALE BUSH	RHFAPT/MBS38/BK	RHFAPT/MBS38/WE	25	
50mm FEMALE ADAPTOR WITH MALE BUSH	RHFAPT/MBS50/BK	RHFAPT/MBS50/WE	20	

258 Series



LOCK RING

Black (RAL 9005) or White (RAL 9010)



Material: PVC	Temperature: -5°/+60°C	
Description	Black	White
20mm LOCK RING	RHFLR 20/BK	RXT-LR 20/WE
25mm LOCK RING	RXT-LR 25/BK	RXT-LR 25/WE



LOCK NUT

Black (RAL 9005) or White (RAL 9010)



Material: PVC	Temperature: -5°/+60°C	
Description	Black	White
16mm LOCK NUT	RHFLN 16/BK	RXT-RL 16/WE
20mm LOCK NUT	RHFLN 20/BK	RXT-RL 20/WE
25mm LOCK NUT	RHFLN 25/BK	RXT-RL 25/WE
32mm LOCK NUT	RHFLN 32/BK	RXT-RL 32/WE
40mm LOCK NUT	RHFLN 40/BK	RXT-RL 40/WE
50mm LOCK NUT	RHFLN 50/BK	RXT-RL 50/WE



MALE BUSH

Black (RAL 9005) or White (RAL 9010)



Material: PVC	Temperature: -5°/+60°C	
Description	Black	White
16mm MALE BUSH	RHFMB 16/BK	RXT-MBS 16/WE
20mm MALE BUSH	RHFMB 20/BK	RXT-MBS 20/WE
25mm MALE BUSH	RHFMB 25/BK	RXT-MBS 25/WE
32mm MALE BUSH	RHFMB 32/BK	RXT-MBS 32/WE
40mm MALE BUSH	RHFMB 40/BK	RXT-MBS 40/WE
50mm MALE BUSH	RHFMB 50/BK	RXT-MBS 50/WE



BENDS

Available in a range of sizes from 20mm to 50mm.



Material: PVC	Temperature: -5°/+60°C		
Description	Black	White	Pack
20mm HEAVY BEND	RHFSB20/BK	RHFSB20/WE	600
25mm HEAVY BEND	RHFSB25/BK	RHFSB25/WE	300
32mm HEAVY BEND	RHFSB32/BK	RHFSB32/WE	120
38mm HEAVY BEND	RHFSB38/BK	RHFSB38/WE	80
50mm HEAVY BEND	RHFSB50/BK	RHFSB50/WE	35

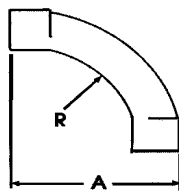
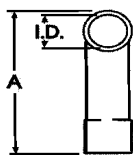

247 Series

Size	Inside Diameter(I.D)	Radius (R)	Bend Length(A)
20mm	20mm	52mm	110mm
25mm	25mm	82mm	160mm
32mm	32mm	112mm	225mm
38mm	38mm	142mm	260mm
50mm	50mm	170mm	325mm



INSPECTION BEND

Black (RAL 9005), for rigid conduits



Material: PVC	Temperature: -5°/+60°C	
Description	Black	White
20mm INSPECTION BEND	RHFIB20/BK	RHFIB20/WE
25mm INSPECTION BEND	RHFIB25/BK	RHFIB25/WE



INSPECTION ELBOW

Black (RAL 9005), for rigid conduits



Material: PVC	Temperature: -5°/+60°C	
Description	Black	White
20mm INSPECTION ELBOW	RHFIE20/BK	RHFIE20/WE
25mm INSPECTION ELBOW	RHFIE25/BK	RHFIE25/WE



INSPECTION TEE

black (RAL 9005), for rigid conduits



Material: PVC	Temperature: -5°/+60°C	
Description	Black	White
20mm INSPECTION TEE	RHFIT20/BK	RHFIT20/WE
25mm INSPECTION TEE	RHFIT25/BK	RHFIT25/WE



SPACER



Material: PVC	Temperature: -5°/+60°C		
Description	Black	White	Pack
20mm SPACER	RHFS 20/BK	RXT-E261S20/WE	100
25mm SPACER	RHFS 25/BK	RXT-E261S25/WE	75
32mm SPACER	RHFS 32/BK	RXT-E261S32/WE	50
38mm SPACER	RHFS 38/BK	RXT-E261S38/WE	50
50mm SPACER	RHFS 50/BK	RXT-E261S50/WE	25

Saddles Spacers set a conduit run off the wall 8mm to allow easier cleaning and repainting and to facilitate entry into equipment. They are available in sizes 20mm to 50mm.

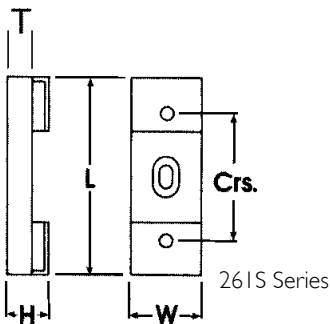

Size	Length(L)	Width(W)	Centres(Crs)	Standoff(T)	Height(H)
20mm	61mm	22mm	40mm	8mm	14mm
25mm	74mm	26mm	48mm	8mm	14mm

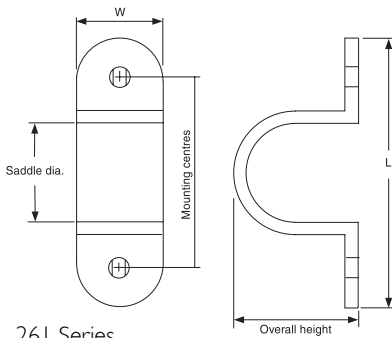

26I Series

STRAP SADDLES



Material: PVC Temperature: -5°/+60°C		Black	White	Pack
Description				
20mm STRAP SADDLE		RHFS20/BK	RHFS20/WE	100
25mm STRAP SADDLE		RHFS25/BK	RHFS25/WE	75
32mm STRAP SADDLE		RHFS32/BK	RHFS32/WE	50
38mm STRAP SADDLE		RHFS38/BK	RHFS38/WE	25
50mm STRAP SADDLE		RHFS50/BK	RHFS50/WE	25

Where neatness and corrosion resistance are imperative, moulded saddles are often the best solution. The 26I Series is tough and UV resistant, and colour matched to the Rexton conduit product range.

Saddles Diameter	Length(L)	Width(W)	Overall Height	Mounting Centres
20mm	57mm	16mm	23mm	40mm
25mm	63mm	20mm	29mm	48mm
32mm	82mm	22mm	35mm	60mm
50mm	105mm	27mm	56mm	78mm



26IS Series

SPACER BAR SADDLES



Material: PVC Temperature: -5°/+60°C		Black	White	Pack
Description				
20mm SPACER BAR SADDLE		RHFSBS20/BK	RHFSBS20/WE	100
25mm SPACER BAR SADDLE		RHFSBS25/BK	RHFSBS25/WE	75
32mm SPACER BAR SADDLE		RHFSBS32/BK	RHFSBS32/WE	50
38mm SPACER BAR SADDLE		RHFSBS38/BK	RHFSBS38/WE	50
50mm SPACER BAR SADDLE		RHFSBS50/BK	RHFSBS50/WE	25

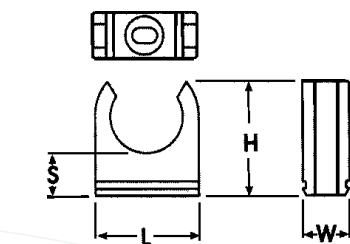

280 Series

MOUNTING CLIP



Material: PVC Temperature: -5°/+60°C		Black	White
Description			
20mm MOUNTING CLIP		RHFCL20/BK	RHFCL20/WE
25mm MOUNTING CLIP		RHFCL25/BK	RHFCL25/WE
32mm MOUNTING CLIP		RHFCL32/BK	RHFCL32/WE
38mm MOUNTING CLIP		RHFCL38/BK	RHFCL38/WE
50mm MOUNTING CLIP		RHFCL50/BK	RHFCL50/WE

280 Series Conduit Clips are a clip in type conduit mount that can be mounted direct onto a wall or other surface, or slid into a 280MC Mounting Channel. They are available in sizes 16mm through to 50mm, and provide a standoff of between 9mm and 13mm.

Conduit Accommodated	Standoff(S)	Leight(L)	Height(H)	Width
20mm	11mm	27mm	29mm	12mm
25mm	13mm	34mm	36mm	12mm
32mm	9mm	41mm	38mm	12mm
50mm	13mm	62mm	54mm	12mm



PVC JOINTING CEMENT

Description	Product Code
PVC Jointing Cement, 250ml Bottle with brush	RXT-240/250/CL
PVC Jointing Cement, 500ml Bottle with brush	RXT-240/500/CL

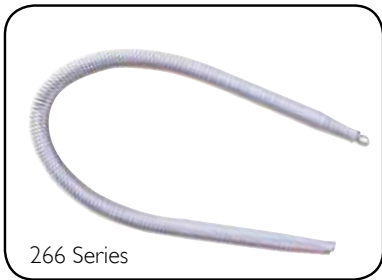

BENDING SPRINGS

Description	Product Code
Bending Springs, 20mm heavy duty	RXT-266HD20
Bending Springs, 25mm heavy duty	RXT-266HD25
Bending Springs, 32mm heavy duty	RXT-266HD32

Manufacturing Specifications

All REXTON Rigid Non Metallic Conduit and Fittings are manufactured in strict accordance with relevant sections of BS 4607 / BS EN 61386 / BS EN 50086 Conduit and Fittings for Electrical Installations.

Operative temperature range -15°C to +65°C.

Most REXTON Conduit Fittings are suitable for use underground and are marked HD (Heavy Duty). Unless specified otherwise all dimensions are nominal.

Chemical Resistance

Resistance to most common corroding agents, including the majority of oils and fats, inorganic acids, alkalis and salts, is a feature of REXTON Rigid Non Metallic Conduit and Fittings. However, they are not recommended for use with Ketones, Esters or Aromatic or Chlorinated Hydrocarbons.

Effects of Temperature

Rigid Non Metallic Conduit has a relatively high co-efficient of expansion (approximately 0.1 metre per 100 metres per 10°C). In long runs likely to be subjected to wide temperature variations, expansion couplings should be provided in each standard length.

Installation

When installing rigid Non Metallic Conduit, support saddles or clips should be located at intervals of not more than one metre. It is not recommended to use Rigid Non Metallic Conduit and Fittings where they are likely to be subjected to severe mechanical abuse without providing additional protection.

Bending Conduit

Circular conduit not exceeding 25mm in diameter can be bent 'cold' using the appropriate REXTON Bending Spring (266 Series). Where heat is required on small conduit, the area to be bent may be heated by brisk rubbing. On larger conduit, heat can be supplied by careful application of an L.P.G. gas flame.

When bending Non Metallic conduit, a minimum radius six times the conduit diameter is recommended.

To maintain a good bend and to reduce 'creep', it is necessary to over bend, then allow the tube to ease to the desired position.

Fix conduit with saddles, or other supports, as soon as possible after bending.

Jointing - Recommended Method

The following is a simple, quick method using REXTON Jointing Cement.

1. Cut conduit to length and remove all burrs.
2. Remove any dirt or grease with a clean cloth dipped in methylated spirits.
3. Coat both surfaces to be joined and within one minute push together. Give a quarter turn to spread cement evenly and wipe off excess immediately.
4. Do not handle joint for five minutes and allow 24 hours drying time before testing or rough handling.

Bending Recommendations	
Conduit Outside Diameter	Minimum Radius
20mm	120mm
25mm	150mm
32mm	200mm
40mm	240mm
50mm	300mm

FLEXIBLE CONDUITS

PART NO	DESCRIPTION
RXT-9020CL/GR	20mm CONDUIT - FLEXIBLE CORRUGATED HEAVY GAUGE GREY 50 metre COIL
RXT-9025CL/GR	25mm CONDUIT - FLEXIBLE CORRUGATED HEAVY GAUGE GREY 50 metre COIL
RXT-9020CL/W	20mm CONDUIT - FLEXIBLE CORRUGATED HEAVY GAUGE WHITE 50 metre COIL
RXT-9025CL/W	25mm CONDUIT - FLEXIBLE CORRUGATED HEAVY GAUGE WHITE 50 metre COIL
RXT-9020CL/BK	20mm CONDUIT - FLEXIBLE CORRUGATED HEAVY GAUGE BLACK 50 metre COIL
RXT-9025CL/BK	25mm CONDUIT - FLEXIBLE CORRUGATED HEAVY GAUGE BLACK 50 metre COIL



FLEXIBLE CONDUITS - TURBO



FXP-TURBO

Pliable Conduit medium gauge, corrugated, with additional plastic coating and sectional corrugation.

Material - PVC-U
Code - EN 3341

Mechan. - > 750 N/5 cm
Temp. - -25°C/+60°C



PART No	dn	di	Small[m]	Large [m]	ref.no.
FXP-Turbo 16	16,0	10,9	50	2700	083 269
FXP-Turbo 20	20,0	14,5	50	2700	083 270
FXP-Turbo 25	25,0	18,8	50	1600	083 271
FXP-Turbo 32	32,0	24,4	25	675	083 272
FXP-Turbo 40	40,0	30,9	25	500	083 273
FXP-Turbo 50	50,0	39,4	25	300	083 274
FXP-Turbo 63	63,0	52,2	25	175	083 275

(In accordance to IEC/EN 61386-22, IEC 60423, IEC 60614-2-3 [formerly BS 6099])

FXPM-TURBO

Pliable Conduit medium gauge, corrugated, with additional sectional corrugation, Silicon Free.

Material - PVC-U, PVC-P
Code - EN 3341

Mechan. - > 750 N/5 cm
Temp. - -25°C/+60°C



PART No	dn	di	Small[m]	Large [m]	ref.no.
FXPM-Turbo 16	16,0	10,7	50	2700	086 553
FXPM-Turbo 20	20,0	14,1	50	2700	086 554
FXPM-Turbo 25	25,0	18,3	50	1600	086 555
FXPM-Turbo 32	32,0	24,3	25	675	089 556
FXPM-Turbo 40	40,0	31,2	25	500	086 557
FXPM-Turbo 50	50,0	39,6	25	300	086 558
FXPM-Turbo 63	63,0	50,6	25	175	086 559

(In accordance to IEC/EN 61386-22, IEC 60423, IEC 60614-2-3 [formerly BS 6099])

FXP

Pliable Conduit medium gauge, corrugated, with draw-in-wire

Material - PVC-U,
Code - EN 3341

Mechan. - > 750
Temp. - -25°C/+60°C



PART No	dn	di	Small[m]	Large [m]	ref.no.
FXP 16	16,0	10,0	50	2700	086 301
FXP 20	20,0	13,5	50	2700	086 303
FXP 25	25,0	18,0	50	1600	086 305
FXP 32	32,0	23,5	25	675	089 306

(In accordance to IEC/EN 61386-22 (replaces IEC 60614-2-3, BS 6099) IEC 60423

GLANDS



STRAIGHT GLAND

Black (RAL 9005, UV stabilised) or light grey (RAL 7035), with metric thread acc. to IEC/EN 60423, IP 65

Material: PVC		Temperature: -25°/+150°C	
Description	Black	Grey	
20.7mm STRAIGHT GLAND	RXT SG/207/BK	RXT SG/207/GR	
27.0mm STRAIGHT GLAND	RXT SG/270/BK	RXT SG/270/GR	
33.8mm STRAIGHT GLAND	RXT SG/338/BK	RXT SG/338/GR	



STRAIGHT GLAND

Halogenfree; black (RAL 9005, UV stabilised) or grey (RAL 7001), patented plug-in system for quick-fit assembly, tight connection, with metric thread, acc. to IEC/EN 60423

Material: PVC		Temperature: -25°/+150°C	
Description	Black	Grey	
16.0mm STRAIGHT GLAND	RXT SGHF/16/BK	RXT SGHF/16/GR	
20.0mm STRAIGHT GLAND	RXT SGHF/20/BK	RXT SGHF/20/GR	
25.0mm STRAIGHT GLAND	RXT SGHF/25/BK	RXT SGHF/25/GR	
32.0mm STRAIGHT GLAND	RXT SGHF/32/BK	RXT SGHF/32/GR	



STRAIGHT CABLE AND CONDUIT GLAND

Halogenfree; black (RAL 9005, UV stabilised) or grey (RAL 7001), patented plug-in system for quick-fit assembly, tight connection, with metric thread acc. to IEC/EN 60423

Material: PVC		Temperature: -25°/+150°C	
Description	Black	Grey	
20.0mm CONDUIT GLAND	RXT SCGHF/20/BK	RXT SCGHF/20/GR	
25.0mm CONDUIT GLAND	RXT SCGHF/25/BK	RXT SCGHF/25/GR	
32.0mm CONDUIT GLAND	RXT SCGHF/32/BK	RXT SCGHF/32/GR	



ELBOW GLAND

Black (RAL 9005, UV stabilised) or light grey (RAL 7035), with metric thread acc. to IEC/EN 60423, IP 65

Material: PVC		Temperature: -25°/+150°C	
Description	Black	Grey	
20.7mm ELBOW GLAND	RXT EG/207/BK	RXT EG/207/GR	
27.0mm ELBOW GLAND	RXT EG/270/BK	RXT EG/270/GR	
33.8mm ELBOW GLAND	RXT EG/338/BK	RXT EG/338/GR	



ELBOW GLAND

Halogenfree; black (RAL 9005, UV stabilised) or grey (RAL 7001), patented plug-in system for quick-fit assembly, tight connection with metric thread acc. to IEC/EN 60423

Material: PVC		Temperature: -25°/+150°C	
Description	Black	Grey	
20.0mm ELBOW GLAND	RXT EGHF/20/BK	RXT EGHF/20/GR	
25.0mm ELBOW GLAND	RXT EGHF/25/BK	RXT EGHF/25/GR	
32.0mm ELBOW GLAND	RXT EGHF/32/BK	RXT EGHF/32/GR	



CABLE AND CONDUIT ELBOW GLAND

Halogenfree; black (RAL 9005, UV stabilised) or grey (RAL 7001), patented plug-in system for quick-fit assembly, tight connection, with metric thread acc. to IEC/EN 60423

Material: PVC		Temperature: -25°/+150°C	
Description	Black	Grey	
20.0mm ELBOW GLAND	RXT ECGHF/20/BK	RXT ECGHF/20/GR	
25.0mm ELBOW GLAND	RXT ECGHF/25/BK	RXT ECGHF/25/GR	
32.0mm ELBOW GLAND	RXT ECGHF/32/BK	RXT ECGHF/32/GR	



FLANGE

Halogenfree; black (RAL 9005, UV stabilised) or grey (RAL 7001), with 4 fixing holes, patented plug-in system for quick-fit assembly, tight connection

Material: PVC		Temperature: -25°/+150°C	
Description	Black	Grey	
20.0mm FLANGE	RXT SFHG/20/BK	RXT SFHG/20/GR	
25.0mm FLANGE	RXT SFHG/25/BK	RXT SFHG/25/GR	
32.0mm FLANGE	RXT SFHG/32/BK	RXT SFHG/32/GR	

PVC TRUNKING AND ACCESSORIES

MINI TRUNKING

SINGLE COMPARTMENT WITH FIXING HOLES



PRODUCT CODE	DESCRIPTION	PACK
RMIK 10/16	Single compartment with fixing holes 40mx6000m/080 956	20
RMIK 16/16	Single compartment with fixing holes 30mx3960m/032 583	20
RMIK 16/25	Single compartment with fixing holes 30mx2520m/032 582	20
RMIK 16/40	Single compartment with fixing holes 30mx1470m/035 587	20
RMIK 25/25	Single compartment with fixing holes 30mx1600m/088 154	20
RMIK 25/40	Single compartment with fixing holes 30mx990m/004 864	20
RMIK 25/50	Single compartment with fixing holes 30mx760m/088 159	20
RMIK 25/60	Single compartment with fixing holes 30mx720m/088 162	20
RMIK 40/40	Single compartment with fixing holes 30mx630m/004 865	20
RMIK 40/60	Single compartment with fixing holes 30mx420m/012 673	20

SINGLE COMPARTMENT WITH FIXING HOLES



PRODUCT CODE	DESCRIPTION	PACK
RMIKA 10/16	Single compartment with adhesive backing - 40mx4200m/040 591	20
RMIKA 16/16	Single compartment with adhesive backing - 30mx3960m/034 549	20
RMIKA 16/25	Single compartment with adhesive backing - 30mx2520m/034 550	20
RMIKA 16/40	Single compartment with adhesive backing holes 30mx1470m/035415	20
RMIKA 25/40	Single compartment with fixing holes 30mx990m/035 416	20
RMIKA 40/40	Single compartment with fixing holes 30mx630m/035 417	20

TWIN COMPARTMENT



PRODUCT CODE	DESCRIPTION	PACK
RMIK 16/40	Twin compartment 30mx1470m/004 866	20
RMIK 25/40/2	Twin compartment 30mx990m/004 867	20

STOP END



PRODUCT CODE	DESCRIPTION	PACK
RSE 16/16	Stop end 50x2500/004 977	100
RSE 16/25	Stop end 50x2500/004 978	100
RSE 16/40	Stop end 20x1000/004 979	100
RSE 25/40	Stop end 20x1000/004 980	100

PVC TRUNKING AND ACCESSORIES

MINI TRUNKING

EXTERNAL ANGLE



PRODUCT CODE	DESCRIPTION	PACK
RSAE 16/16	External angle 20/400/004 961	100
RSAE 16/25	External angle 10 /400/004 964	100
RSAE 16/40	External angle 10x200/004 962	100
RSAE 25/40	External angle 10/150/004 963	100
RSAE 40/40	External angle 10/150/023 004	100
RSAE 40/60	External angle 24/023 614	100

INTERNAL ANGLE

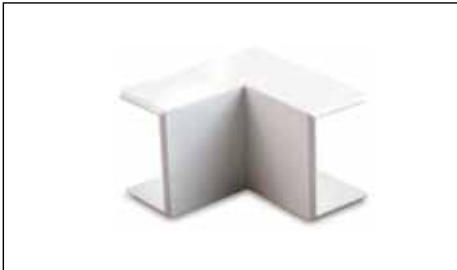

PRODUCT CODE	DESCRIPTION	PACK
RSIE 16/16	Internal angle 20/400/004 966	100
RSIE 16/25	Internal angle 10/400/004 967	100
RSIE 16/40	Internal angle 10/200/004 969	100
RSIE 25/40	Internal angle 10/150/004 970	100
RSIE 40/40	Internal angle 10/150/023 005	100
RSIE 40/60	Internal angle 24/023 613	100

COUPLING



PRODUCT CODE	DESCRIPTION	PACK
RSK 16/16	Coupling 20/800/004 951	100
RSK 16/25	Coupling 20/800/004 952	100
RSK 16/40	Coupling 20/800/004 953	100
RSK 25/40	Coupling 20/300/004 954	100
RSK 40/40	Coupling 10/800/004 955	100
RSK 40/60	Coupling 5/200/025 614	100

FLAT ANGLE



PRODUCT CODE	DESCRIPTION	PACK
RFSW 16/16	Flat angle 20/ 800/004 956	100
RFSW 16/25	Flat angle 10/400/004 957	100
RFSW 16/40	Flat angle 5/200/004 958	100
RFSW 25/40	Flat angle 5/100/004 959	100
RFSW 40/40	Flat angle 5/50/023 003	100
RFSW 40/60	Flat angle 32/023 612	100

PVC TRUNKING AND ACCESSORIES

MINI TRUNKING

FLAT TEE

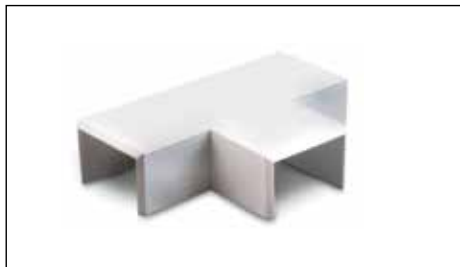

PRODUCT CODE	DESCRIPTION	PACK
RST 16/16-16/16*	Flat Tee 10/400/004 971	100
RST 16/25-16/25	Flat Tee 10/300/004 974	100
RST 16/40-16/40	Flat Tee 5/150/004 972	100
RST 25/40-25/40	Flat Tee 5/100/004 973	100
RST 40/40-40/40	Flat Tee 5/100/023 006	100
RST 40/60-40/60	Flat Tee 32/023 611	100

LEFT & RIGHT INTERSECTION



PRODUCT CODE	DESCRIPTION	PACK
RSWAL 16/25	Left Intersection 10/200/004 982	100
RSWAR 16/25	Right Intersection 10/200/004 983	100

SIDE TEE



PRODUCT CODE	DESCRIPTION	PACK
RSA 16/25-16/25	Side Tee - 10/300/004 984	100

TRUNKING ADAPTOR



PRODUCT CODE	DESCRIPTION	PACK
RSKE 16/16	Trunking Adaptor; 50/1000/004 986	100
RSKE 16/25	Trunking Adaptor 50/1000/004 987	100

PVC TRUNKING AND ACCESSORIES

MAXI TRUNKING

SINGLE COMPARTMENT WITH FIXING HOLES



PRODUCT CODE	DESCRIPTION	PACK
RMAK 50/50	Maxi Trunking 12m/ 624m/ 036 996	20
RMAK 50/75	Maxi Trunking 12m/ 312m/ 036 997	20
RMAK 50/150	Maxi Trunking 6m/ 210m/ 022 788	20
RMAK 75/75	Maxi Trunking 12m/ 288m/ 019 008	20
RMAK 75/100	Maxi Trunking 6m/ 204m/ 019 010	20
RMAK 75/150	Maxi Trunking 6m/ 144m/ 022 953	20
RMAK 100/100	Maxi Trunking 6m/ 156m/ 019 011	20
RMAK 100/150	Maxi Trunking 3m/ 102m/ 022 789	20
RMAK 150/150	Maxi Trunking 3m/ 72m/ 022 790	20

STOP END



PRODUCT CODE	DESCRIPTION	PACK
RME 50/50	Stop end 50/ 800/ 019 308	20
RME 50/75	Stop end 25/ 400/ 019 310	20
RME 50/100	Stop end 50/ 800/ 019 308	20
RME 50/150	Stop end 20/ 320/ 022 163	20
RME 75/75	Stop end 50/ 400/ 019 311	100
RME 75/100	Stop end 25/ 200/ 019 312	100
RME 100/100	Stop end 20/ 160/ 019 313	100
RME 100/150	Stop end 15/ 120/ 022 167	100
RME 50/50	Stop end 50/ 800/ 019 308	100
RME 150/150	Stop end 10/ 80/ 022 169	100

EXTERNAL ANGLE



PRODUCT CODE	DESCRIPTION	PACK
RMAE 50/50	External angle 1/ 40/ 019 262	20
RMAE 50/75	External angle 1/ 20/ 019 263	20
RMAE 50/100	External angle 1/ 12/ 019 264	20
RMAE 50/150	External angle 1/ 5/ 022 962	20
RMAE 75/75	External angle 1/ 18/ 019 265	100
RMAE 75/100	External angle 1/ 12/ 019 266	100
RMAE 75/150	External angle 1/ 4/ 022 963	100
RMAE 100/100	External angle 1/12/ 019 267	100
RMAE 100/150	External angle 1/ 4/ 022 964	100
RMAE 150/150	External angle 1/4/ 022 965	100

PVC TRUNKING AND ACCESSORIES

MAXI TRUNKING

INTERNAL ANGLE



PRODUCT CODE	DESCRIPTION	PACK
RMIE 50/50	Internal angle 1/ 40/ 019 250	20
RMIE 50/75	Internal angle 1/ 20/ 019 251	20
RMIE 50/100	Internal angle 1/ 12/ 019 252	20
RMIE 50/150	Internal angle 1/ 5/ 022 958 T	20
RMIE 75/75	Internal angle 1/ 16/ 019 253	100
RMIE 75/100	Internal angle 1/ 12/ 019 254	100
RMIE 75/150	Internal angle 1/ 4/ 022 959	100
RMIE 100/100	Internal angle 1/ 19/ 019 255	100
RMIE 100/150	Internal angle 1/ 4/ 022 960	100
RMIE 150/150	Internal angle 1/ 4/ 022 961	100

FLAT ANGLE



PRODUCT CODE	DESCRIPTION	PACK
RMFW 50/50	Flat angle 1/ 40/ 019 286	20
RMFW 50/75	Flat angle 1/ 24/ 019 287	20
RMFW 50/100	Flat angle 1/ 20/ 019 288	20
RMFW 50/100	Flat angle 1/ 20/ 019 288	20
RMFW 75/75	Flat angle 1/ 20/ 019 289	100
RMFW 75/100	Flat angle 1/ 15/ 019 290	100
RMFW 75/150	Flat angle 1/ 6/ 022 967	100
RMFW 100/100	Flat angle 1/ 9/ 019 291	100
RMFW 100/150	Flat angle 1/ 6/ 022 968	100
RMFW 150/150	Flat angle 1/ 4/ 022 969	100

FLAT TEE



PRODUCT CODE	DESCRIPTION	PACK
RMFT 50/50	Flat tee 1/ 25/ 019 274	100
RMFT 50/75	Flat tee 1/ 20/ 019 275	100
RMFT 50/100	Flat tee 1/ 12/ 019 276	20
RMFT 50/150	Flat tee 1/ 5/ 022 970	20
RMFT 75/75	Flat tee 1/ 12/ 019 277	100
RMFT 75/100	Flat tee 1/ 8/ 019 278	100
RMFT 75/150	Flat tee 1/ 4/ 022 971	100
RMFT 100/100	Flat tee 1/ 10/ 019 279	100
RMFT 100/150	Flat tee 1/ 3/ 022 972	100
RMFT 150/150	Flat tee 1/ 1/ 022 973	100

PVC TRUNKING AND ACCESSORIES

MAXI TRUNKING

EXTERNAL ANGLE

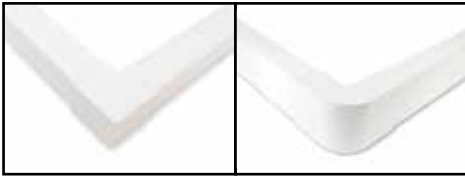

PRODUCT CODE	DESCRIPTION	PACK
RMAES 50/50	External angle 1/ 50/ 085 634	100
RMAES 50/100	External angle 1/ 20/ 086 042	100

INTERNAL ANGLE

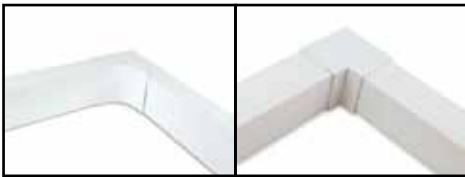

PRODUCT CODE	DESCRIPTION	PACK
RMIES 50/50	Internal angle 1/ 50/ 085 632	100
RMIES 50/100	Internal angle 1/ 20/ 086 043	100

COVER JOINT



PRODUCT CODE	DESCRIPTION	PACK
RMK 50/50	Cover joint 100/ 2400/ 019 317	20
RMK 50/75	Cover joint 100/ 1600/ 019 318	20
RMK 50/100	Cover joint 100/ 1200/ 019 319	20
RMK 50/150	Cover joint 100/ 800/ 025 055	20
RMK 75/75	Cover joint 100/ 1600/ 019 31	100
RMK 75/100	Cover joint MK 100/ 1200/ 019 319	100
RMK 75/150	Cover joint 100/ 800/ 025 055	100
RMK 100/100	Cover joint 100/ 1200/ 019 319	100
RMK 100/150	Cover joint 100/ 800/ 025 055	100
RMK 150/150	Cover joint 100/ 800/ 025 055	100

TRUNKING DIVIDER



PRODUCT CODE	DESCRIPTION	PACK
RMTW 50/50	Trunking divider 30m/ 4500m/ 019 717	100
RMTW 50/75	Trunking divider 30m/ 4500m/ 019 717	100
RMTW 50/100	Trunking divider 30m/ 4500m/ 019 717	100
RMTW 50/150	Trunking divider 30m/ 3300m/ 019 718	100
RMTW 75/75	Trunking divider 30m/ 3300m/ 019 718	100
RMTW 75/100	Trunking divider 30m/ 3300m/ 019 718	100
RMTW 75/150	Trunking divider 30m/ 1500m/ 019 719	100
RMTW 100/100	Trunking divider 30m/ 1500m/ 019 719	100
RMTW 100/150	Trunking divider 30m/ 1500m/ 019 719	100
RMTW 150/150	Trunking divider 30m/ 1500m/ 019 719	100

CABLE RETAINER



PRODUCT CODE	DESCRIPTION	PACK
RMHK 50	Cable retainer 50/ 800/ 019 32	100
RMHK 75	Cable retainer 50/ 800/ 019 330	100
RMHK 100	Cable retainer 50/ 400/ 019 331	100

PVC TRUNKING AND ACCESSORIES

STARLINE

SKIRTING TRUNKING



PRODUCT CODE	DESCRIPTION	PACK
RSLS 50/170	Skirting trunking 3m/ 180m/ 036 054	100
RSLS 50/250	Skirting trunking 3m/ 380m/ 086 045	100

CHAMBERED DADO TRUNKING



PRODUCT CODE	DESCRIPTION	PACK
RSLC 50/170	Chamfered dado trunking 3m/ 180m/ 036 055	100
RSLC 50/250	Chamfered dado trunking 3m/ 380m/ 086 047	100

SQUARE DADO TRUNKING



PRODUCT CODE	DESCRIPTION	PACK
RSLQ 50/170	Square dado trunking 3m/ 180m/ 036 056	100
RSLQ 50/250	Square dado trunking 3m/ 380m/ 086 048	100

SILVER ANODISED FINISHING



PRODUCT CODE	DESCRIPTION	PACK
RALU 10065 AG	3m/ 034 200	100
RALU 10065 AG	3m/ 034 200	100

STOP END



PRODUCT CODE	DESCRIPTION	PACK
RALE 100 RH	Stop end 1/ 034 267	100
RALE130 RH	Stop end 1 1/ 034 271	100
RALE 170 RH	Stop end 1 1/ 034 275	100
RALE 100 AG	Stop end 1 1/ 034 268	100
RALE 130 AG	Stop end 1 1/ 034 272	100
RALE 170 AG	Stop end 1 1/ 034 276	100

PVC TRUNKING AND ACCESSORIES

STARLINE

EXTERNAL ANGLE



PRODUCT CODE	DESCRIPTION	PACK
RALA 100 RH	External angle 1/ 034 209	100
RALA 130 RH	External angle 1/ 034 213	100
RALA 170 RH	External angle 1/ 034 217	100
RALA 100 AG	External angle 1/ 034 210	100
RALA 130 AG	External angle 1/ 034 214	100
RALA 170 AG	External angle 1/ 034 218	100

INTERNAL ANGLE



PRODUCT CODE	DESCRIPTION	PACK
RALI 100 RH	Internal angle 1/ 034 242	100
RALI 130 RH	Internal angle 1/ 034 246	100
RALI 170 RH	Internal angle 1/ 034 250	100
RALI 100 AG	Internal angle 1/ 034 243	100
RALI 130 AG	Internal angle 1/ 034 247	100
RALI 170 AG	Internal angle 1/ 034 251	100

FLAT ANGLE



PRODUCT CODE	DESCRIPTION	PACK
RALF 100 RH	Flat angle 1/ 034 254	100
RALF 130 RH	Flat angle 1/ 034 258	100
RALF 170 RH	Flat angle 1/ 034 262	100
RALF 100 AG	Flat angle 1/ 034 255	100
RALF 130 AG	Flat angle 1/ 034 259	100
RALF 170 AG	Flat angle 1/ 034 263	100

TRUNKING LID



PRODUCT CODE	DESCRIPTION	PACK
RALD RH	Trunking lid 3m/ 034 234	100
RALD RH	Trunking lid 3m/ 034 234	100
RALD RH	Trunking lid 3m/ 034 234	100
RALD AG	Trunking lid 3m/ 034 235	100
RALD AG	Trunking lid 3m/ 034 235	100
RALD AG	Trunking lid 3m/ 034 235	100

DRAW WIRE



DRAW WIRE- Nylon



DRAW WIRE- Hook + Hook



DRAW WIRE- Hook + Ball

Product Code	Description
	DRAW WIRE: HOOK+HOOK
RDWN10	Draw Wire Nylon - 10mtrs
RDWN15	Draw Wire Nylon - 15mtrs
RDWN20	Draw Wire Nylon - 20mtrs
RDWN25	Draw Wire Nylon - 25mtrs
RDWN30	Draw Wire Nylon - 30mtrs
	DRAW WIRE: HOOK+HOOK
RDWS10	Draw Wire Steel - 10mtrs
RDWS15	Draw Wire Steel - 15mtrs
RDWS20	Draw Wire Steel - 20mtrs
RDWS25	Draw Wire Steel - 25mtrs
RDWS30	Draw Wire Steel - 30mtrs
	DRAW WIRE: HOOK+BALL
RDWS	HB 18 Draw Wire Steel - 10mtrs
RDWS	HB 15 Draw Wire Steel - 15mtrs
RDWS	HB 20 Draw Wire Steel - 20mtrs
RDWS	HB 25 Draw Wire Steel - 25mtrs
RDWS	HB 30 Draw Wire Steel - 30mtrs

DRY LINING BOXES

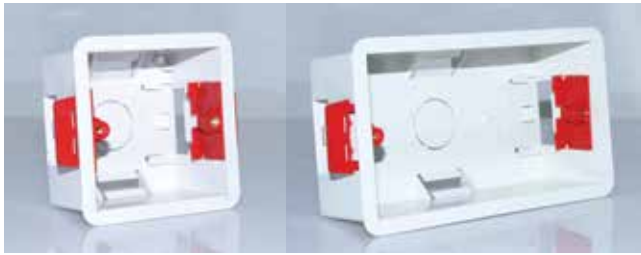

RDLB135

RDLB235

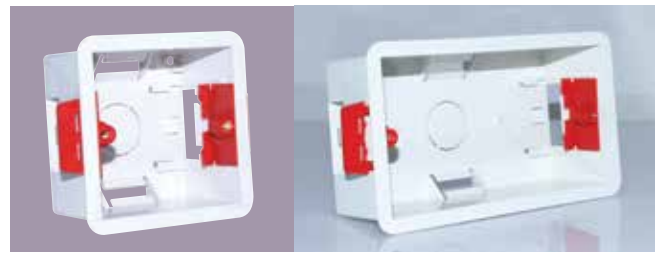

RDLB147

RDLB247



RDLBD35



RDLBR35



RDLBT35

PRODUCT CODE	DESCRIPTION
RDLB135	DRY LINING BOX 1 GANG 35MM DEEP
RDLB235	DRY LINING BOX 2 GANG 35MM DEEP
RDLB147	DRY LINING BOX 1 GANG 47MM DEEP
RDLB247	DRY LINING BOX 2 GANG 47MM DEEP
RDLBD35	DRY LINING BOX DUAL GANG 35MM DEEP FOR TWO 1G ACCESSORIES
RDLBT35	DRY LINING BOX 2+1GANG 35MM DEEP
RDLBR35	DRY LINING BOX ROUND 35MM DEEP 62MM DIA

DRY LINING BOXES - FLUSH FITTING

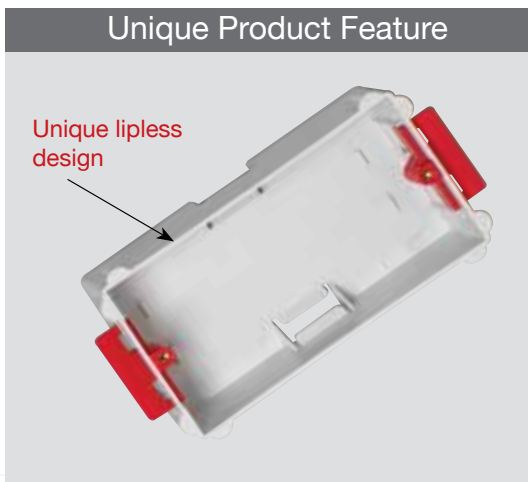

RDLBF135



RDLBF235

PRODUCT CODE	DESCRIPTION
RDLBF135	DRY LINING BOXES FLUSH FITTING 1 GANG 35MM DEEP
RDLBF235	DRY LINING BOXES FLUSH FITTING 2 GANG 35MM DEEP

GI SWITCH BOXES

bsi.
Approved



Fixed lugs



Adjustable installation lugs



Brass earth terminal



Knockouts of two sizes

7 mm
Thickness

9 mm
Thickness

1.1 mm
Thickness

ORDERING CODE	SYS.CODE	DESCRIPTION
RB167	R224107-16	SWITCH BOX GI FLUSH WITH ADJUSTABLE LUGS 3 x 3 x 16mm x .7mm
RBT167	R224207-16	SWITCH BOX GI FLUSH WITH ADJUSTABLE LUGS 3 x 6 x 16mm x .7mm
RB257	R224107-25	SWITCH BOX GI FLUSH WITH ADJUSTABLE LUGS 3 x 3 x 25mm x .7mm
RBT257	R224207-25	SWITCH BOX GI FLUSH WITH ADJUSTABLE LUGS 3 x 6 x 25mm x .7mm
RB357	R224107-35	SWITCH BOX GI FLUSH WITH ADJUSTABLE LUGS 3 x 3 x 35mm x .7mm
RBT357	R224107-35	SWITCH BOX GI FLUSH WITH ADJUSTABLE LUGS 3 x 6 x 35mm x .7mm
RB169	R224109-16	SWITCH BOX GI FLUSH WITH ADJUSTABLE LUGS 3 x 3 x 16mm x .9mm
RBT169	R224209-16	SWITCH BOX GI FLUSH WITH ADJUSTABLE LUGS 3 x 6 x 16mm x .9mm
RB259	R224109-25	SWITCH BOX GI FLUSH WITH ADJUSTABLE LUGS 3 x 3 x 25mm x .9mm
RBT259	R224209-25	SWITCH BOX GI FLUSH WITH ADJUSTABLE LUGS 3 x 6 x 25mm x .9mm
RB359	R224109-35	SWITCH BOX GI FLUSH WITH ADJUSTABLE LUGS 3 x 3 x 35mm x .9mm
RBT359	R224109-35	SWITCH BOX GI FLUSH WITH ADJUSTABLE LUGS 3 x 6 x 35mm x .9mm
RB479	R224109-47	SWITCH BOX GI FLUSH WITH ADJUSTABLE LUGS 3 x 3x 47mm x 0.9mm
RBT479	R224209-47	SWITCH BOX GI FLUSH WITH ADJUSTABLE LUGS 3 x 6 x 47mm x 0.9mm
RB3511	R224111-35	SWITCH BOX GI FLUSH WITH ADJUSTABLE LUGS 3 x 3 x 35mm x 1.1mm
RBT3511	R224211-35	SWITCH BOX GI FLUSH WITH ADJUSTABLE LUGS 3 x 6 x 35mm x 1.1mm
RB4711	R224111-47	SWITCH BOX GI FLUSH WITH ADJUSTABLE LUGS 3 x 3 x 47mm x 1.1mm
RBT4711	R224211-47	SWITCH BOX GI FLUSH WITH ADJUSTABLE LUGS 3 x 6 x 47mm x 1.1mm

METAL BOXES

GI SWITCH BOXES



1+1 GANG



2+2 GANG



2+1 GANG



2+1+1 GANG



2+2+1 GANG



1+1+1 GANG



ORDERING CODE	SYS.CODE	DESCRIPTION
RB3359	R224309-35	SWITCH BOX 1+1G 35MM/0.9MM WITH ONE ADJUSTABLE LUG AND EARTH TERMINAL
RB4359	R224409-35	SWITCH BOX 2+2G 35MM/0.9MM WITH ONE ADJUSTABLE LUG AND EARTH TERMINAL
RB5359	R224509-35	SWITCH BOX 2+1G 35MM/0.9MM WITH ONE ADJUSTABLE LUG AND EARTH TERMINAL
RB6359	R224609-35	SWITCH BOX 2+1+1G 35MM/0.9MM WITH ONE ADJUSTABLE LUG AND EARTH TERMINAL
RB7359	R224709-35	SWITCH BOX 2+2+1G 35MM/0.9MM WITH ONE ADJUSTABLE LUG AND EARTH TERMINAL
RB8359	R224809-35	SWITCH BOX 1+1+1G 35MM/0.9MM WITH ONE ADJUSTABLE LUG AND EARTH TERMINAL

GI ADAPTABLE BOXES



ORDERING CODE	SYS.CODE	DESCRIPTION
RAB109	R225109	3x3x2 Plain Adaptable Box
RAB109K	R225109K	3x3x2 KO Adaptable Box
RAB209	R225209	4x4x2 Plain Adaptable Box
RAB209K	R225209K	4x4x2 KO Adaptable Box
RAB309	R225309	4x4x3 Plain Adaptable Box
RAB309K	R225309K	4x4x3 KO Adaptable Box
RAB409	R225409	6x6x2 Plain Adaptable Box
RAB409K	R225409K	6x6x2 KO Adaptable Box
RAB509	R225509	6x6x3 Plain Adaptable Box
RAB509K	R225509K	6x6x3 KO Adaptable Box
RAB609	R225609	6x6x4 Plain Adaptable Box
RAB609K	R225609K	6x6x4 KO Adaptable Box
RAB112	R225112	3x3x2 Plain Adaptable Box
RAB112K	R225112K	3x3x2 KO Adaptable Box
RAB212	R225212	4x4x2 Plain Adaptable Box
RAB212K	R225212K	4x4x2 KO Adaptable Box
RAB312	R225312	4x4x3 Plain Adaptable Box
RAB312K	R225312K	4x4x3 KO Adaptable Box
RAB412	R225412	6x6x2 Plain Adaptable Box
RAB412K	R225412K	6x6x2 KO Adaptable Box
RAB512	R225512	6x6x3 Plain Adaptable Box
RAB512K	R225512K	6x6x3 KO Adaptable Box

RAISED FLOOR BOXES



RFB 302 0

RXG Code: 93090A A

3 COMPARTMENT FLOOR BOX EMPT Y

315mm x 210mm x 75mm - without plate s

RFB 3020-FTD

RXG Code: 93089AA

3 COMPARTMENT FLOOR BOX FITTE D

315mm x 210mm x 75mm fitted with

Accessory Plates: RXTRF-3200 / RXTRB-3000 / RXTRF-3200J



Specifications

- Floor box manufactured from galvanised steel
- 25 & 20mm knockouts to accept flexible conduit
- Frame & lid moulded from flame retardant ABS
- Galvanised lid insert for strength
- Easy grip recessed lifting handle
- Compact design 298 x 202mm floor cut-out
- Clamp fixing for fast installation
- Special plates available to order
- Suitable for carpeted floors only
- ABS Plastic Frame & Lid Load Test 450 K G

Dimensions

Floor Cut Out:	298 x 202m m
Floor Box Depth:	75mm
Plug Top Clearance:	23mm
Overall Frame & Lid:	315 x 210m m
Frame Lid Recess:	8 mm
Accessories Plates:	200 x 85m m

ACCESSORY PLATES

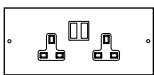

RXTRFW1462LP
RXG Code: 93187AA
2 gangswitched
Socket outlet

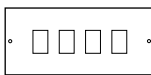

RXTRF-3200J
RXG Code: 93152AA
Data/Telecoms plate
38mm x 25mm
knock outs

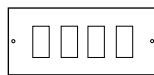

RXTRF-3200J/50
RXG Code: 93153AA
Data/Telecoms plate
50mm x 25mm
knock outs



RXTRF-3345
RXG Code: 93150AA
Punched plate for
2 x 1 gang
accessories

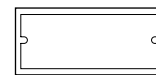

RXTRF-3200
RXG Code: 93149AA
Punched plate for
2 gang
accessories



RXTRB-3000
RXG Code: 93151AA
Blank Plate

PART NO	DESCRIPTION
RXT-RFSB3075/3-UNFTD	RAISED FLOOR SERVICE OUTLET BOX 315X210X75, W/O MOUNTING PLATE & U-LI CHOP/3 COMPARTMENTS
CU-3345J	2G MOUNT PLATE-1PC
CU-3200J	2GANG ACCESSORY PLATE - 2 N
CB-3000	BLANK PLATE -1 PC

UNDER FLOOR - SERVICE OUTLET BOX



- Overall depth 56mm for 25mm trunking
- Overall depth 75mm for 38mm trunking
- Standard Finish: Epoxy Powder Coated
- Pre-Galvanised sheet complies to BS EN 10143:1993, BS 1004 :1985 Zinc Alloy for Die Casting

PRODUCT CODE	SPECIFICATIONS
RUF5B250/250/3	Under floor service outlet box 250x250x75/90, 3 compartments
RUF5B300/300/3	Under floor service outlet box 300x300x75/90, 3 compartments
RUF13ADSP	Dual Socket Plate for Under Floor service outlet box 13 Amp
RUF13ASSP	Dual Single Socket Plate for Under Floor service outlet box 13 Amp
RUFDSP	Data Socket Plate for Under Floor service outlet box
RUFDSP/RJ45	Data Socket Plate for 4 RJ45 fo Under Floor service outlet box
RUFBP	Blank Plate for Under Floor service outlet box

UNDER FLOOR - JUNCTION BOX

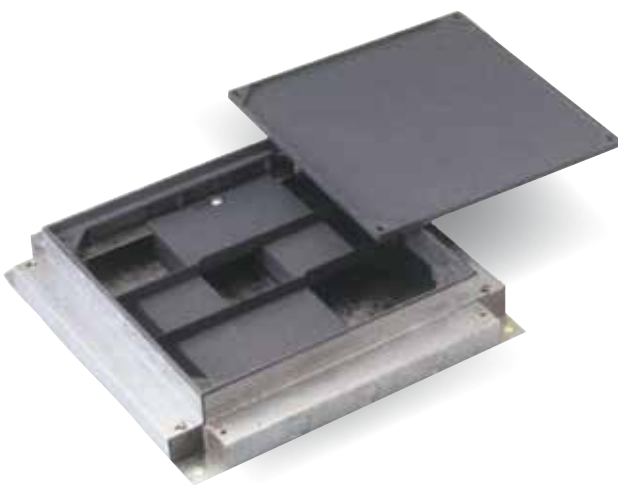

The junction box comes complete with 4 conduit Knockout Plates. It can be used as a Terminal, Through, Bend, Tee, Fourway or Conduit box. Flyover is also supplied.

- Adjustable upwards by 15mm
- Overall depth 56mm for 25mm trunking
- Overall depth 75mm for 38mm trunking
- Lid recess 6mm and 9mm for carpet or vinyl tile finishes.

PRODUCT CODE	SPECIFICATIONS
RUFJBG250/250/90/3	Junction box 250x250x75/90 , 3 compartments
RUFJBG300/300/90/3	Junction box 300x300x75/90, 3 compartments

PRODUCT SAFETY DATA SHEET – PVC-U ELECTRICAL CONDUITS

1. IDENTIFICATION OF THE SUBSTANCE/PREPARATION AND COMPANY

PVC-U-ELECTRICAL CONDUITS

Supplier:

REXTON TECHNOLOGIES MIDDLE EAST
 P.O. Box: 8080, Sharjah, UAE
 Tel: +971 6 557 0555, Fax: +971 6 557 0707
 Email: info@rextontechnologies.com
 Website: www.rextontechnologies.com

2. COMPOSITION/INFORMATION ON INGREDIENTS

A. EXTRUSIONS

(For all product manufactured from January 2008)

Polyvinyl chloride	Approx. 85%
Zn salts (as Zn)	Less than 0.1%
Calcium carbonate	Less than 6%
Titanium dioxide	Less than 3.5% (White only)
Other	To 100%

B. MOULDINGS

Polyvinyl chloride	Approx. 85%
Tin salts (as Sn)	Less than 1.0%
Calcium carbonate	Less than 6%
Titanium dioxide	Less than 3.5% (White only)
Other	To 100%

3. HAZARDS IDENTIFICATION

No specific hazards as the ingredients are bound into the PVC matrix and are thus rendered virtually insoluble.

4. FIRST AID MEASURES

Inhalation:	Very low risk of inhalation
Eye contact:	Not applicable
Skin contact:	Not applicable
Ingestion:	Very low risk of ingestion

(Normal first aid procedures are applicable for handling extruded profiles and mouldings).

5. FIRE FIGHTING MEASURES

All available fire fighting extinguishers are effective for fighting fires involving PVC, although due care must be taken of the primary source of the fire e.g. live electrical equipment.

The major products of combustion/decomposition of PVC include hydrogen chloride, carbon monoxide and carbon dioxide. Suitable breathing apparatus should be provided.

6. ACCIDENTAL RELEASE MEASURES

No specific hazards.

7. HANDLING AND STORAGE

There are no specific hazards when handling and storing PVC electrical conduits, trunking and fittings.

The products should however be stored and handled in accordance with the relevant recommendations of of Rexton Technologies

8. EXPOSURE CONTROLS/PERSONAL PROTECTION

INGREDIENT	8 HRTWA
Sn	WEL 0.10mg/m ³

Ref: HSE EH40/2005 Workplace exposure limits

The additives are bound into the PVC matrix and are thus rendered virtually insoluble. By virtue of the size of the products manufactured from PVC it is very unlikely that normal exposure will lead to (material) hazards to eyes, skin, inhalation or ingestion.

9. PHYSICAL AND CHEMICAL PROPERTIES

Physical state: Solid
 Density: 1.35 – 1.45 g/cc
 Softening point: Extrusions 82°C BS 2782 Method 120 B
 Mouldings 74°C BS 2782 Method 120B
 Solubility in Water: Insoluble
 Solubility in other: Soluble in cyclohexanone, tetrahydrofuran, 1,2 – dichlorethane
 Oxygen Index: Approx. 45%

10. STABILITY AND REACTIVITY

Stable under the recommended storage and handling conditions (see sect7.). In a fire hazardous decomposition products such as smoke, carbon monoxide, carbon dioxide and hydrogen chloride may be produced.
 With the exception of sulphuric acid (>90%) and nitric acid (>50%) the material is resistant to most acids and alkalis up to 60°C, but above this temperature the stronger acids attack the polymer.

11. TOXICOLOGICAL INFORMATION

The finished products in use present a very low level of risk. They should not however be used for applications for direct contact with foodstuffs.

12. ECOLOGICAL INFORMATION

The products are insoluble in water and will not degrade when buried in landfills etc.

13. WASTE DISPOSAL

Any waste products may be disposed of to landfill in accordance with any local restrictions.

14. TRANSPORT INFORMATION

Not classified as dangerous for transport.

15. REGULATORY INFORMATION

Not classified as dangerous for supply.

16. OTHER INFORMATION

This product should only be used as directed by Rexton Technologies and should not be used for any other application other than as directed. For further information contact our Technical Services Department. This safety data sheet was compiled using the current safety information supplied by the distributors of the component materials.

Abbreviations: PVC=Polyvinylchloride, PE=Polyethylene, PP=Polypropylene, PC=Polycarbonate, PA=Polyamide, PPE/PPO=Polyphenyleneether/Polyphenyleneoxide															
Chemical Attack	Conc.%	°C	PVC	PE/PP	PC	PA	PPE/PPO	Chemical Attack	Conc.%	°C	PVC	PE/PP	PC	PA	PPE/PPO
Acetaldehyde, aqueous	40	40	Ø	+	-	Ø	Ø	Hydrofluoric acid, aqueous	<40	20	+	+	-	+	Ø
Acetic acid	<10	40	+	+	+	Ø	Ø	Hydrogen	100	60	+	+	+	+	+
Acetic acid	10-85	60	+	+	-	-	Ø	Hydrogen peroxide	20	20	+	+	Ø	Ø	-
Acetic acid	85-95	40	+	+	-	-	Ø	Hydrogen sulphide, dry or humid	60	+	+	Ø	Ø	Ø	Ø
Acetic acid	>95	20	+	+	-	-	-	Hydrogen sulphide, aqueous	40	+	+	Ø	Ø	Ø	Ø
Acetone	trace	20	-	+	-	+	-	Ketone	-	-	-	-	+	-	-
Ammonia, aqueous	20	40	+	+	-	+	Ø	Lactic acid, aqueous	1	40	+	+	+	+	+
Ammonia, dry	60	+	+	-	+	Ø	Methyl alcohol, aqueous	all	40	+	+	-	+	+	+
Ammonium fluoride	2	20	+	Ø	Ø	-	Mineral oil	20	+	+	Ø	+	Ø	Ø	Ø
Aniline	saturated	60	Ø	-	-	Ø	-	Nitric acid	<30	40	+	+	-	-	Ø
Arsenic acid	<20	60	+	+	+	Ø	-	Nitric acid	30-45	45	+	+	-	-	-
Beer	60	+	+	Ø	+	+	-	Nitric acid	50-60	20	+	Ø	-	-	-
Benzene	20	-	Ø	-	+	-	-	Nitric gases, dry or humid	weak	60	Ø	Ø	-	Ø	Ø
Bleaching agent	12,5	40	+	+	Ø	Ø	+	Oils and Fats (vegetable),	-	-	-	-	-	-	-
Borax, aqueous	60	+	+	Ø	Ø	Ø	-	Oils and Fats (organic)	60	+	+	-	+	-	-
Bromic acid, aqueous	10	20	+	+	-	-	-	Oxalic acid, aqueous	10	40	+	+	+	Ø	Ø
Butane, gaseous	+	-	+	+	+	Ø	-	Oxalic acid, aqueous	conc.	60	+	+	-	-	Ø
Carbonic acid, dry	40	+	+	+	+	Ø	-	Oxygen	60	+	+	Ø	+	+	+
Carbonic acid, dry or humid	40	+	+	Ø	+	Ø	-	Ozone	20	+	Ø	-	Ø	Ø	Ø
Carbon tetrachloride	20	-	-	-	+	-	-	Permanganate	<6	20	+	+	Ø	-	Ø
Carbon disulphide	20	Ø	Ø	-	Ø	-	-	Petrol, Normal/Premium	60	+	Ø	-	+	-	-
Caustic soda	>40	40	+	+	-	+	+	Petroleum	20	+	+	Ø	+	-	-
Caustic soda	40-60	60	+	+	-	+	+	Pheno., aqueous	<90	45	Ø	Ø	-	-	-
Cement, dry	20	+	+	+	+	+	+	Phosphoric acid, aqueous	<30	40	+	+	-	-	Ø
Chloric gas, dry or humid	20	Ø	Ø	-	-	-	-	Phosphoric acid, aqueous	<30	60	+	+	-	-	Ø
Chloric water	20	Ø	-	-	-	-	-	Potash lye, aqueous	40	40	+	+	-	+	+
Chlorinated hydrocarbons	-	-	-	-	+	-	-	Potash lye	40-50	60	+	+	-	+	++
Chlorosulfuric acid	100	20	Ø	Ø	-	-	-	Potassium sodium lye	<40	40	+	+	-	+	+
Chromium acid, aqueous	<50	50	+	+	-	-	-	Propane, liquid	+	-	+	+	+	+	Ø
Chromium acid	20	Ø	Ø	+	-	-	-	Salt solution	all	40	+	+	+	+	+
Chromosulfuric acid	20	Ø	Ø	-	-	-	-	Seawater	40	+	+	Ø	+	+	+
Citric acid	all	60	+	+	+	+	Ø	Sulfur dioxide, aqueous	all	40	+	+	Ø	Ø	Ø
Cresol, aqueous	<90	45	Ø	Ø	-	-	-	Sulfuric acid, dry or humid	all	60	+	+	Ø	Ø	Ø
Cupric Sulfate	all	60	+	+	+	Ø	Ø	Sulfuric acid, aqueous	<40	40	+	+	Ø	-	+
Diesel oil	20	+	+	Ø	+	-	-	Sulfuric acid, aqueous	40-80	60	+	+	-	-	Ø
Developer (phot.)	40	+	+	Ø	+	Ø	-	Sulfuric acid, aqueous	80-90	40	+	+	-	-	Ø
Dextrine	18	20	+	+	Ø	+	Ø	Sulfuric acid, aqueous	90-96	20	+	+	-	-	Ø
Ester	-	-	-	-	+	+	-	Sodium chloride solution	weak	40	+	+	+	+	+
Ethyl alcohol, aqueous	<40	40	+	+	Ø	+	+	Tartaric acid	10	60	+	+	+	+	Ø
Ethyl ether	20	-	Ø	Ø	+	-	-	Urine	40	+	+	+	+	+	+
Fatty acid	20	+	Ø	Ø	+	Ø	-	Water	60	+	+	+	+	+	+
Fixing bath	40	+	+	Ø	+	Ø	-	Xylene	100	20	-	Ø	-	+	-
Fluorochlorinated hydrocarbons	+	Ø	+	+	+	-	-	Zinc chloride, aqueous	all	60	Ø	+	Ø	-	Ø
Formaldehyde, aqueous	all	30	+	+	Ø	+	-	Zinc sulfate, aqueous	weak	60	+	+	Ø	-	Ø
Formic Acid	<30	40	+	+	Ø	-	Ø								
Formic Acid	conc.	20	+	+	-	-	Ø								
Glycerine, aqueous	60	+	-	Ø	+	+	-								
Hydrochloric acid	weak	40	+	+	Ø	-	+								
Hydrochloric acid	conc.	60	+	+	-	-	Ø								
Hydrofluosilic acid, aqueous	<32,5	60	+	+	+	-	Ø								

All given values refer to standard test samples under standardized laboratory conditions. Design and specifications subject to change without notice.

CABLE CAPACITIES OF CONDUIT AND TRUNKING

(Appendix A of the 16th Edition of the I.E.E Regulations/UK)

Introduction:

This appendix describes a method which can be used to determine the size of conduit or trunking necessary to accommodate cables of the same size, or differing sizes and provides a means of compliance with Regulation 522-08, which states "The number of cables drawn into, or laid in, an enclosure of a wiring system shall be such that no damage is caused to the cables or to the enclosure during their installation". The method employs a unit system, each cable size being allocated a factor. The sum of all factors for the cables intended to be run in the same enclosure is compared against the factors given for conduit or trunking, as appropriate, in order to determine the size of the conduit or trunking necessary to accommodate those cables.

It has been found necessary, for conduit, to distinguish between

1. Straight runs not exceeding 3metres in length, and
2. Straight runs exceeding 3 metres, or runs of any length incorporating bends or sets.

The term 'Bend' signifies a standard 90° bend, and one double set is equivalent to one bend. For the case 1, each conduit size is represented by only one factor. For the case 2, each conduit size has a variable factor which is dependent on the length of run and the number of bends or sets. For a particular size of cable the factor, allocated to it for case 1 is not the same for case 2. For trunking each size of cable has been allocated a factor, as has been each size of trunking.

Because of certain aspects, such as the assessment of reasonable care of pulling-in, acceptable utilization of the space available and the dimensional tolerance of cables, conduit and trunking, any method of standardizing the cable capacities of such enclosures can only give guidance on the number of cables which can be accommodated. Thus the sizes of conduit or trunking determined by the method given in this appendix are those which can be reasonably expected to accommodate the desired number of cables in a particular run using an acceptable pulling force and with the minimum probability of damage to cable insulation. Only mechanical considerations have been taken into account in determining the factors given in the following tables. As the number of circuits in a conduit or trunking increases, the current-carrying capacities of the cables must be reduced accordingly. It may therefore be more attractive economically to divide the circuits concerned between two or more enclosures.

This appendix deals with the following four cases:

Single-core P.V.C. insulated cables in straight runs of conduit not exceeding 3m in length.

Single-core P.V.C. insulated cables in straight runs of conduit exceeding 3m in length incorporating bends or sets.

Single-core P.V.C. insulated cables in trunking.

Other sizes and types of cable in trunking.

For other cables and/or conduits not covered by the tables, advice on the number of cables which can be accommodated should be obtained from the manufacturers.

TABLE 12A	Cable factors for short straight runs		TABLE 12B	Conduit factors for short straight runs		TABLE 12C	Cable factors for long straight runs or runs incorporating bends			TABLE 12E	Cable factors for trunking			TABLE 12F	Factor for trunking	
Type of conductor	Conductor cross-sectional area mm ²	Factor	Conduit dia. mm	Factor	Type of conductor	Conductor cross-sectional area mm ²	Factor	Type of conductor	Conductor cross-sectional area mm ²	Factor	Dim. of trunking mm	Factor	Dim. of trunking mm	Factor		
Solied	1	22	16	290	Solied or stranded	1	16	Solied	1.5	7.1	50x37.5	767	50x50	1037		
	1.5	27	20	460		1.5	22		2.5	10.2	75x25	738	75x37.5	1146		
	2.5	39	25	800		2.5	30		1.5	8.1	75x50	1555	75x75	2371		
Stranded	1.5	31	32	1400		4	43	2.5	11.4	100x37.45	1542	100x50	2091			
	2.5	43	38	1900		6	58	4	15.2	100x75	3189	100x100	4252			
	4	58	50	3500		10	105	6	22.9							
	6	88					10	36.3								
10	146															

TABLE 12D	Conduit factors for runs incorporating bends																			
	Length of run, m.	Conduit diameter, mm																		
		Straight				One bends				Two bends				Three bends				Four bends		
	16	20	25	32	16	20	25	32	16	20	25	32	16	20	25	32	16	20	25	32
1.0	Covered by Tables 12A and 12B				188	303	543	947	177	286	514	900	158	256	463	818	130	213	388	692
1.5					182	294	528	923	167	270	487	857	143	233	422	750	111	182	333	600
2.0					177	286	514	900	158	256	463	818	130	213	388	692	97	159	292	529
2.5					171	278	500	878	150	244	442	783	120	196	358	643	86	141	260	474
3.0					167	270	487	857	143	233	422	750	111	182	333	600				
3.5	179	290	521	911	162	263	475	837	136	222	404	720	103	169	311	563				
4.0	177	286	514	900	158	256	463	818	130	213	388	692	97	159	292	529				
4.5	174	282	507	889	154	250	452	800	125	204	373	667	91	149	275	500				
5.0	171	278	500	878	150	244	442	783	120	196	358	643	86	141	260	474				
6.0	167	270	487	857	143	233	422	750	111	182	333	600								
7.0	162	263	475	837	136	222	404	720	103	169	311	563								
8.0	158	256	463	818	130	213	388	692	97	159	292	529								
9.0	154	250	452	800	125	204	373	667	91	149	275	500								
10.0	150	244	442	783	120	196	358	643	86	141	260	474								

CHEMICAL RESISTANCE OF PVC-U

The resistance against chemical attack basically on the mechanical stress of the plastic part, the time of exposure, the temperature and the concentration of the media. In view of the various environmental conditions laboratory tests under standard conditions are only of limited value for practical use. Under critical conditions tests should be made according to actual conditions to be stated by the user.

Mechanical stress and temperature

Mechanical stress can be minimized at the installation, taking care that the system is being installed as stressfree as possible, e.g. using large bending radii, leaving space for thermal expansion at the joints and taking care, that fixings are not fastened too firmly. Using insulating systems at higher temperatures, the thermal expansion must be taken into account to avoid later stresses on the installed system by using expansion joints and allow gliding within the fixings. At higher temperatures it must be taken into consideration that especially in sealed closed systems, temperatures may occur exceeding the surrounding temperatures. This can be due to additional heat through the cables or heat radiation (sunlight), the following survey gives general information about possible incompatibilities occurring during installation or use.

Chemical resistance of PVC Systems

PVC offers excellent resistance against most chemicals used in the building industry. Care shall be taken with chemicals like carbon tetrachloride acetone, chlorinated hydrocarbons and benzene.

FIRE BEHAVIOUR

Rexton Conduits designed for indoor use are basically self extinguishing and non flame propagating. Moreover there are some other aspects which have to be taken into consideration in case of fire.

A very important point is the density (opacity) of the released smoke in safety areas (e.g. emergency exits). It is not only important how much smoke is totally released; more important is how rapidly the smoke is released. The slower the smoke density increases, the longer safe getaway is available.



International Offices :

UNITED KINGDOM

Rexton Technologies UK
Newcombe House, Newcombe Way,
Orton Southgate, Peterborough, PE2 6SE
Tel: +44 (0) 0844 372 7750
Fax +44 (0) 0844 372 7760
Email: rexton@redringxpelair.com
info@rextontechnologies.co.uk

USA

Rexton Technologies-US
4607 Sundown Court
Missouri City Houston Texas 77459
Tel: +1 281 962 4646
Fax: +1 281 241 6660
E-mail: info@rextontechnologies.us

CANADA

Rexton Technologies Canada Inc.
27, River Rock Crescent
Brampton Ontario L7A2V2, Canada
Tel: +1 905 970 9077
Fax: +1 905 495 8277
Email: info@rextontechnologies.ca

MIDDLE EAST-UAE

Rexton Technologies Middle East
M4-18 Saif Zone, P.O. Box: 8080
Sharjah, UAE
Tel: +971 6 509 6666
Fax: +971 6 557 8828
Email: info@rextontechnologies.com

QATAR

Rexton Technologies
P.O. Box: 202368, Doha, Qatar
Tel: +974 4444 0899
Fax: +974 4411 5944

BAHRAIN

Rexton Technologies
P.O. Box: 75691, Kingdom of Bahrain

INDIA

Bangalore

Rexton Automation (India) Pvt. Ltd.
75, BDA Complex, Indira Nagar,
Bangalore: 560038, Karnataka, India
Tel: +91 80 4123 77 77, 4151 77 77

Cochin

Rexton Automation (India) Pvt. Ltd.
401, Pioneer Towers, Marine Drive
Cochin-682 031, Kerala
Tel: +91 484 4117 777, 4037 777
E-mail: sales@rexton.co.in

Gurgaon

1039, Spaze I-Tech Park
Tower-A, Sohna Road Sector-49
Gurgaon (Haryana)-122018
Tel: +91 124-6517777
Email: sales@rexton.co.in