

THT



CJTHT/PLUS



THT-IMP-0



FANS FOR THE SMOKE EXTRACTION

400°C/2h - 300°C/2h - 200°C/2h



EN-12101-3-2002
Powered smoke and
heat exhaust ventilators
for use in Construction Works





OUR COMMITMENT TO THE ENVIRONMENT

Sodeca has begun a new stage of study and design of new trends in ventilation which will help to preserve the environment and to make the energy saving which so much concerns today's society.



In order to obtain an improvement in the energetic consumption, SODECA has adjusted the impellers in the maximum efficiency working area. For this reason there might be changes in the curves of this catalogue compared to previous editions.

SODECA has concentrated its activity on the production of industrial fans, ventilation systems and extractors for the removal of smoke in case of fire since 1983, when it was founded.

SODECA's fans and extractors are present in all European countries and in many parts of the world, thanks to the quality of the product and the methods of research and development used.

Our quality procedures used and certified by BUREAU VERITAS, in accordance with ISO 9001:2008, are another of the reasons which make **SODECA** one of the best and most renowned fan manufacturers in Europe.

Without a doubt, the most important factor to achieve our objectives is the human factor, the great professionals who work at your service, offering not only ventilation equipment but also solutions to any ventilation need required by our customers.

We sincerely offer you the possibility of visiting our facilities in Sant Quirze de Besora, with over 16,000 square metres of built area, where you will be able to see our fan manufacture with perfect clarity and with the highest standards of quality, complying with the ISO and AMCA standards.

This catalogue is only a small part of our possibilities. Do not hesitate to contact us. We will put all our experience and our human resources at your disposal.



*installations
headquarters of
SODECA s.a.,
at Sant Quirze
de Besora and
manufacturing plant
in Santiago
de Chile.*



FANS FOR THE SMOKE EXTRACTION AND OVERPRESSURE SYSTEMS



Thanks to the knowledge acquired during our 25 years' experience in the manufacture of fans for continuous working at high temperature, SODECA has become specialised in the manufacture of fans for the removal of smoke in case of fire and overpressure systems for the control of smoke in facilities for escape routes in case of fire.

If our manufacturing systems are certified by external quality certification organisations such as BUREAU VERITAS, the quality controls for the manufacturing processes and control of the fans for removing smoke at a temperature are also completely audited by independent organisations such as APPLUS, to ensure the correct functioning and compliance with the regulations and technical characteristics of the fans.

All our fans for removing smoke comply with the demands of the European Standard EN-12101-3-2002 "Powered smoke and heat exhaust ventilators for use in Construction Works", and are certified by an independent laboratory and accredited by the European Directives

Summary of approvals and certificates:

■ They are delivered with the F-400 authorisation, and are suitable for applications F-300 and F-200

Series	Type	S2 Service			EC mark		
		F200 200°C-120min	F300 300°C-120min	F400 400°C-120min	F200 (120min)	F300 (60min)	F400 (120min)
THT - THT/ATEX	AXIAL FAN	x	x	x	0370-CPD-0514	0370-CPD-0973	0370-CPD-0305
CJTHT/PLUS	AXIAL FAN	x	x	x	0370-CPD-0515	0370-CPD-0974	0370-CPD-0312
CJTHT - CJTHT/ATEX	AXIAL FAN	x	x	x	0370-CPD-0515	0370-CPD-0974	0370-CPD-0312
CJTHT/DUPLEX/ATEX	AXIAL FAN		x	x		0370-CPD-0974	0370-CPD-0312
THT/IMP	AXIAL FAN IMPULSIONS	x	x	x	0370-CPD-0394	0370-CPD-0822	0370-CPD-0822
VST	TUNNEL JETFAN			x			1511-CPD-0128
VMSF	AXIAL FAN			x			1511-CPD-0104
CI	CENTRIFUGAL FAN IMPULSIONS		x			0370-CPD-0715	
HTMF	AXIAL ROOF FAN		x	x		0370-CPD-0544	0370-CPD-0544
CJBDT	CENTRIFUGAL FAN		x	x		0370-CPD-0888	0370-CPD-0580
CBDT	CENTRIFUGAL FAN		x	x		0370-CPD-0888	0370-CPD-0580
TCR	CENTRIFUGAL FAN		x	x		0370-CPD-0384	0370-CPD-0384
CTMP	CENTRIFUGAL FAN		x	x		0370-CPD-0397	0370-CPD-0397
CJS	CENTRIFUGAL FAN		x	x		0370-CPD-0398	0370-CPD-0398
CJMD	CENTRIFUGAL FAN		x	x		0370-CPD-0399	0370-CPD-0399
TCR/R	CENTRIFUGAL FAN	■	■	x			0370-CPD-0400
CJTCR/R	CENTRIFUGAL FAN	■	■	x			0370-CPD-0401
TCMP	CENTRIFUGAL FAN	■	■	x			0370-CPD-0313
CJMP	CENTRIFUGAL FAN	■	■	x			0370-CPD-0402
CJTX-C	CENTRIFUGAL FAN	■	■	x			0370-CPD-0468
CJSX	CENTRIFUGAL FAN	■	■	x			0370-CPD-0503
CJSRX	CENTRIFUGAL FAN	■	■	x			0370-CPR-1578
CSX	CENTRIFUGAL FAN	■	■	x			0370-CPR-1577
CJLINE	CENTRIFUGAL FAN	■	■	x			0370-CPD-0594
CJEC	CENTRIFUGAL FAN	■	■	x			0370-CPD-0382
CHT	CENTRIFUGAL ROOF FAN	■	■	x			0370-CPD-0897
CVT	CENTRIFUGAL ROOF FAN	■	■	x			0370-CPD-0897

INSIDE

Installation of fan inside fire danger zone

<p>THT</p>  <p>Cased axial fans 400°C/2h, 300°C/2h and 200°C/2h</p> <p>12</p>	<p>CJTHT/PLUS</p>  <p>400°C/2h, 300°C/2h y 200°C/2h extraction units with built-in noise reducer</p> <p>20</p>	<p>CJTHT</p>  <p>400°C/2h, 300°C/2h and 200°C/2h axial extraction units with soundproofed box</p> <p>24</p>	<p>CJTHT/DUPLEX/ATEX</p>  <p>400°C/2h extraction units, with ATEX certification, category 2 Ex II2G in accordance with Spanish Low Voltage Regulation ITC 29 ATEX and NBE-CP/96 for Zone 1 and 2 rated car parks.</p> <p>30</p>
<p>THT/HATCH</p>  <p>High-powered ventilators with motorised opening and equipped with a roof fan, for smoke extraction in the event of a fire, 400°C/2h</p> <p>92</p>	<p>THT/IMP</p>  <p>400°C/2h, 300°C/2h and 200°C/2h single-direction or reversible long-range impulsion fans with circular or rectangular design</p> <p>97</p>	<p>TÚNEL JETFAN</p>  <p>Powertur Jet fans especially designed for tunnel ventilation, 400°C/2h, 300°C/2h and 200°C/2h Certificates</p> <p>101</p>	<p>VMSF</p>  <p>Cased high-pressure axial fans, certified 400°C/2h</p> <p>105</p>
<p>CI</p>  <p>300°C/2h centrifugal induction fans.</p> <p>107</p>	<p>HTMF</p>  <p>Multifunctional 400°C/2h and 300°C/2h roof fans</p> <p>109</p>	<p>CJBDT</p>  <p>Extraction units to work inside fire danger zones at 400°C/2h and 300°C/2h, with soundproofed box</p> <p>115</p>	<p>CBDT</p>  <p>Centrifugal double inlet and direct motor fans for working inside fire danger zones 400°C/2h and 300°C/2h, with possibility of single-phase motor</p> <p>115</p>
<p>TCR</p>  <p>400°C/2h and 300°C/2h centrifugal fans with backward-curved impeller</p> <p>119</p>	<p>CTMP</p>  <p>400°C/2h and 300°C/2h centrifugal fans with multi-blade impeller</p> <p>122</p>	<p>CJS</p>  <p>400°C/2h and 300°C/2h extraction units with exchangeable hatches</p> <p>125</p>	<p>CJMD</p>  <p>400°C/2h and 300°C/2h extraction units with linear inlet and outlet</p> <p>128</p>

OUTSIDE

Installation of fan outside fire danger zone

TCR/R



400°C/2h centrifugal fans with backward-curved impeller.

132

CJTCR/R



400°C/2h extraction units with backward-curved impeller.

132

TCMP



400°C/2h centrifugal fan with multi-blade impeller.

137

CJMP



400°C/2h extraction units with multi-blade impeller

137

CJTX-C



400°C/2h extraction units with inside belt-driven motor and automatic belt tensing device

143

CJSX



400°C/2h belt-driven extraction units with single-inlet fan

155

CSX



162

CJSRX



172

CJLINE



400°C/2h extraction units with linear inlet and outlet

175

CJEC



400°C/2h Extraction hoods for kitchens and 2-speed motor

180

CHT



400°C/2h centrifugal roof fans with horizontal outlet air, hood in aluminium

183

CVT



400°C/2h centrifugal roof fans with vertical outlet air, hood in aluminium

183

KIT SOBREPRESIÓN FOR ESCAPE ROUTES



KIT DE SOBREPRESIÓN

KIT SOBREPRESIÓN WITH RESERVE FAN

188

FULFILMENT OF STANDARDS

SODECA's fans and extractors comply with the following standards:

QUALITY	
ISO 9001:2008	Sistemas de gestión de la calidad. Requisitos. Quality management systems -- Requirements
TESTS	
ISO 5801	Ventiladores industriales. Industrial fans -- Performance testing using standardized airways Industrial fans -- Performance testing using standardized airways
AMCA 210-99	Ventiladores industriales. Métodos de ensayos de ventiladores y su representación de ensayos. Laboratory Methods of Testing Fans for Aerodynamic Performance Rating
UNE 100212:1990	Ventiladores. Dispositivos e instalaciones para el ensayo de ventiladores.
ISO 13350	Ventiladores industriales. Ensayos de comportamiento de ventiladores de chorro. Industrial fans -- Performance testing of jet fans
ISO 13348	Industrial fans -- Tolerances, methods of conversion and technical data presentation
FANS FOR HIGH TEMPERATURES	
EN 12101-3:2002	Sistemas de control de humos y calor. Parte 3: Especificaciones para aireadores extractores de humos y calor mecánicos. Smoke and heat control systems - Part 3: Specification for powered smoke and heat exhaust ventilators
ACOUSTICS	
ISO 3744	Acústica. Determinación de los niveles de potencia acústica de fuentes de ruido a partir de la presión acústica. Método de ingeniería para condiciones de campo libre sobre un plano reflectante. Acoustics -- Determination of sound power levels of noise sources using sound pressure -- Engineering method in an essentially free field over a reflecting plane
BALANCE AND VIBRATIONS	
ISO 1940-1	Vibraciones mecánicas. Calidad de equilibrio Mechanical vibration -- Balance quality requirements for rotors in a constant (rigid) state -- Part 1: Specification and verification of balance tolerances
ISO 10816-1	Vibraciones mecánicas. Evaluación de las vibraciones de máquinas Mechanical vibration -- Evaluation of machine vibration by measurements on non-rotating parts -- Part 1: General guidelines
ISO 14694	Ventiladores industriales. Especificaciones para equilibrio y niveles de vibración Industrial fans -- Specifications for balance quality and vibration levels
SAFETY (Declaration of EC Compliance)	
EN ISO 12100-1	Seguridad de las máquinas. Conceptos básicos, principios generales para el diseño. Parte 1: Terminología básica, metodología. Safety of machinery -- Basic concepts, general principles for design -- Part 1: Basic terminology, methodology
EN ISO 12100-2	Seguridad de las máquinas. Conceptos básicos, principios generales para el diseño. Parte 2: Principios técnicos. Safety of machinery -- Basic concepts, general principles for design -- Part 2: Technical principles
EN 60204-1	Seguridad de las máquinas. Equipo eléctrico de las máquinas. Parte 1: Requisitos generales. Safety of machinery - Electrical equipment of machines - Part 1: General requirements
EN 294	Seguridad de máquinas. Distancias de seguridad para impedir que se alcancen zonas peligrosas con los miembros superiores Safety of machinery; safety distances to prevent danger zones from being reached by the upper limbs
ISO 13857	Seguridad de máquinas. Distancias de seguridad para impedir que se alcancen zonas peligrosas con los miembros superiores e inferiores. Safety of machinery -- Safety distances to prevent danger zones being reached by upper and lower limbs
UNE 100250	Ventiladores industriales. Seguridad mecánica de los ventiladores (equivalente ISO 12499)
ISO 12499	Ventiladores industriales. Seguridad mecánica en los ventiladores Industrial fans -- Mechanical safety of fans -- Guarding
DIRECTIVES	
Directiva 2006/42/CE	Directiva de máquinas Machinery Directive
Directiva 2006/95/CE	Directiva de baja tensión Low Voltage Directive
Directiva 2004/108/CE	Directiva compatibilidad electromagnética EMC Directive
Directiva 89/106/CE	Directiva productos de construcción Construction Products Directive (CPD)
Directiva 2009/125/CE	Directiva de requisitos de diseño ecológico para productos que utilizan energía. Ecodesign Requirements for Energy-related Products Directive
ATEX EXECUTIONS	
Directiva ATEX 94/9/CE	Aparatos y sistemas de protección para uso en atmósferas potencialmente explosivas Equipment and protective systems intended for use in potentially explosive atmospheres
EN 14986	Diseño de ventiladores para trabajar en atmósferas potencialmente explosivas. Design of fans working in potentially explosive atmospheres
EN 13463-1	Equipos no eléctricos destinados a atmósferas potencialmente explosivas. Parte 1: Requisitos y metodología básica. Non-electrical equipment for use in potentially explosive atmospheres - Part 1: Basic method and requirements
EN 1127-1	Atmósferas explosivas. Prevención y protección contra la explosión. Parte 1: Conceptos básicos y metodología. Explosive atmospheres - Explosion prevention and protection - Part 1: Basic concepts and methodology

Smoke extraction for: **CAR PARKS**

Method of smoke extraction by means of fans certified for work at temperature during a specific period of time according to classification and certification. This method is habitually applied in blocks, shopping centres, tunnels, car parks and other large buildings and with large open areas, also in industrial buildings with a high risk of fire and for smoke extraction in industrial kitchens.



FAN INSIDE

Installation of fan inside fire danger zone



FAN OUTSIDE

Installation of fan outside fire danger zone



JET FAN TYPE IMPULSION FAN

Installation of impulsion fan inside fire danger zone



Smoke extraction for: **INDUSTRIAL KITCHENS**

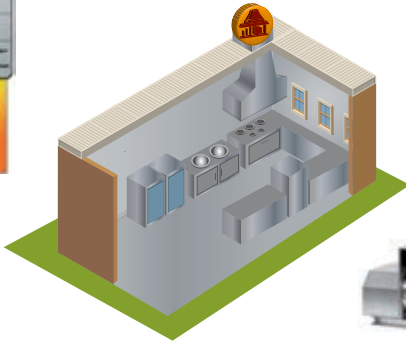

Fans suitable for use in industrial kitchens
For the correct application of the standard:

- C.T.E. Technical Building Code Basic SI Document for fire safety Basic HS Document for health and safety



Smoke extraction for: **INDUSTRIAL BUILDINGS**



Fans suitable for use in industrial buildings
For the correct application of the standard:

- Regulation for Fire Safety in Industrial Buildings, Royal Decree 2267/2004, UNE-23585:2004 Fire Safety



Control of smoke by differential pressure for: **ESCAPE ROUTES**



Overpressure smoke control method; this system consists of pressurization by means of the injection of air in spaces which are used as escape routes for people in case of fire, such as stair wells, passageways, corridors, elevators, etc. Above all in densely occupied tall buildings. This method is based on smoke control by means of the speed of air and the artificial barrier which is created by excess air pressure over smoke, so that it cannot enter escape routes. In accordance with standard EN-12101-6-2006

STAIRWELL KIT SOBREPRESION FOR THREE-PHASE EQUIPMENT



STAIRWELL KIT SOBREPRESION FOR SINGLE-PHASE EQUIPMENT



KIT SOBREPRESION WITH RESERVE FAN





TUNNEL JET FAN

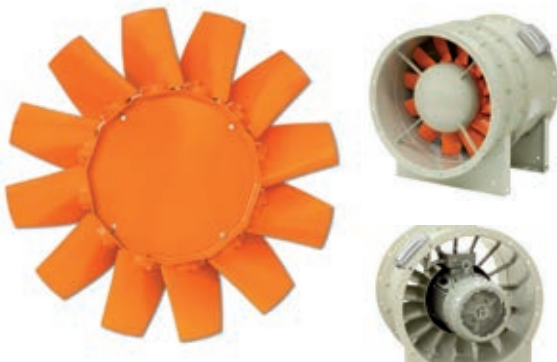

Smoke extraction for: **TUNNELS**

TUNNEL VENTILATION

Tunnels play an important part in the global development of economies, contributing to the creation of large infrastructures and the improvement of urban communications. Most tunnel ventilation covers road tunnels, metro tunnels and railway tunnels.

The safety and air quality requirements are the most important aspects in the demand for tunnel ventilation, both for new constructions and in the improvement and adaptation of old infrastructures.

Although the main objective of tunnel ventilation is safety and smoke control in case of fire, the control of emissions of combustion gases from vehicles also plays an important part.



LATEST TUNNEL INSTALLATIONS

Reference:
RENTERIA TUNNEL VARIANT (GUIPUZCOA)
Longitudinal ventilation of the tunnel, using Tunnel Jetfan type fans certified for 400°C/2h. Model THT/IMP-C-125-4T

Reference:
PLAZA DE LUGO TUNNEL IN A CORUÑA
Longitudinal ventilation of the tunnel, using Tunnel Jetfan type fans certified for 400°C/2h. Model THT/IMP-C-125-4T

Reference:
PLAZA ESPAÑA TUNNEL IN FERROL
Longitudinal ventilation of the tunnel, using Tunnel Jetfan type fans certified for 400°C/2h. Model THT/IMP-C-100-4T

Reference:
LINE 9 BARCELONA UNDERGROUND RAILWAY
Ventilation of different stations and ventilation shafts, using different sizes of fans certified for 400°C/2h from the THT series

Reference:
METRO WARSAW
Ventilation of different stations with VST Tunnel Jetfan fans certified for 400°C/2h. Model: VST-1600-4T-100 for an airflow of 193,000 m³/h with a 75Kw motor

Reference: **TUNNELS HIGHWAY C-17 in Ripoll (Girona-Spain)**
Longitudinal ventilation of the tunnel using fans type Tunnel Jetfan certified for 400°C/2h. Model VST-1400-7-4-100

TUNNEL VENTILATION SYSTEMS

There are basically three ways of ventilating tunnels:

Longitudinal ventilation: The air flow goes in the same direction as the axis of the tunnel. The air enters one of the ends of the tunnel and leaves at the other end. This is used in tunnels that are not excessively long, up to two kilometres in severe conditions and up to five kilometres in not-so-severe conditions, or if the traffic is all in one direction. This ventilation can be divided into a number of sections with intermediate extractions and injections of fresh air, in this case, the system of ventilation can be used for tunnels of greater length, up to ten kilometres.

Longitudinal Ventilation

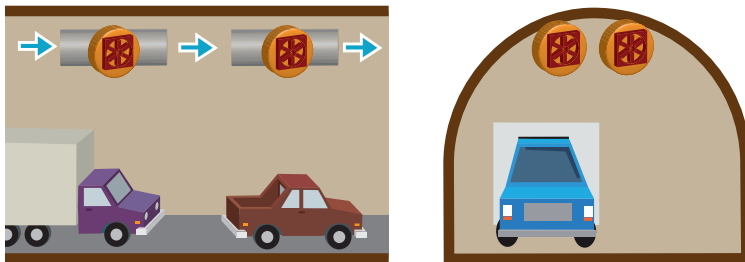

In normal practice, reversible fans are used, so as to be able to adapt the direction of circulation of the air according to the traffic needs, making it possible to compensate for the piston effect caused by the passage of vehicles through the tunnel.

Transverse ventilation: The air flow direction is transverse to the axis of the tunnel. Clean air is injected uniformly along the entire length of the tunnel and by means of one or several channels, and the extracted air is also drawn out along the length of the entire tunnel and in a uniform manner. So as to limit losses of load, these ducts are divided transversely into independent sections of between 1000 and 1600 metres. The best system consists of blowing in fresh air through the sides of the traffic surface and extracting the used air from the upper part of the tunnel.

Transverse Ventilation

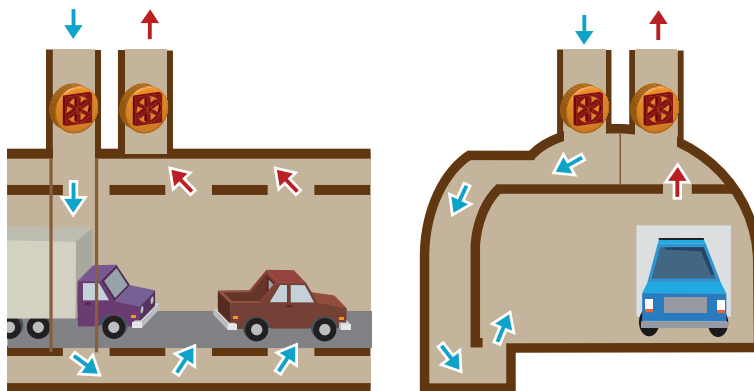

This system is considered to be the safest and most comfortable; it is independent of the influence of weather, the wind speed at the inlets and of the air speed caused by the vehicles. Even so, this system is the most expensive for investment and for the operating costs.

It is generally used in road tunnels of medium length and long tunnels with high traffic loads.

Semi-Transverse ventilation: The fresh clean air is injected in a direction that is transverse to the axis of the tunnel, by means of a parallel channel running along the whole length of the tunnel and the used air leaves through the two ends of the tunnel.

Semi-Transverse Ventilation

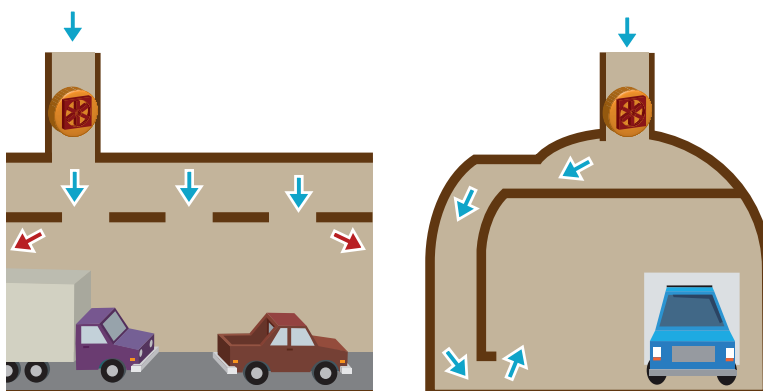

This system has the advantage of being able to make a reversible system so that it is possible, in the case of a fire, to invert the direction of air flow and in this way extract the smoke and gases from the fire through the upper part of the tunnel.

It is generally used in road tunnels of medium length with not very high traffic loads.

THT



Detail THT/Atex

THT: Cased axial fans 400°C/2h, 300°C/2h and 200°C/2h

THT/ATEX: Cased axial fans 400°C/2h, 300°C/2h and 200°C/2h with ATEX certification



Short casing axial fans for working inside fire danger zones.
THT/ATEX: with ATEX certification, category 3 Ex II3G. In accordance with Spanish Low Voltage Regulation ITC 29 ATEX for Zone 2 rated car parks.

Fan:

- Sheet steel short casing. THT/ATEX: with aluminium strip in the impeller area in accordance with Standard EN-14986:2005.
- Turnable cast aluminium impellers.
- Approval according to Standard EN-12101-3-2002, certificate no.: 0370-CPD-0305.
- Airflow direction from motor to impeller.

Motor:

- Class H motors, ongoing use S1 and emergency use S2, with ball bearings, IP55 protection, and one or two speeds depending on the model.
- Three-phase 230/400V.-50Hz. (up to 4CV.) and 400/690V.-50Hz. (power over 4CV.)
- Max. temperature of air for transport: S1 Service -20°C+ 40°C for ongoing use, S2 Service 200°C/2h, 300°C/2h, 400°C/2h

Finish:

- Anticorrosive finish in polyester resin, polymerised at 190°C, after alkaline degreasing and phosphate-free pre-treatment.

On request:

- Long casing fans with inspection hatch
- 100% reversible impellers.

Order code

From size 40 to size 100

THT — 56 — 4T — 2 — F-400

THT: Short cased axial fans 400°C/2h, 300°C/2h and 200°C/2h

Impeller diameter in cm.

Number of motor poles

T=Three-phase

Power motor (c.v.)

F-200 Officially approved 200°C/2h

THT/ATEX: Short cased axial fans 400°C/2h, 300°C/2h and 200°C/2h with ATEX certification

- 2=2900 r/min. 50 Hz
- 4=1400 r/min. 50 Hz
- 6=900 r/min. 50 Hz
- 8=750 r/min. 50 Hz
- 12=500 r/min. 50 Hz

- F-300 Officially approved, tested for 300°C/2h
- F-400 Officially approved 400°C/2h
- CAT3: With ATEX certification, Category 3 Ex II3G.

THT/CL: Long cased axial fans 400°C/2h, 300°C/2h and 200°C/2h with long casing, equipped with an inspection door

From size 125 to size 160

THT — 125 — 4T / 9-10 — 15 — F-400

THT: Short cased axial fans 400°C/2h, 300°C/2h and 200°C/2h

Impeller diameter in cm.

Number of motor poles

T=Three-phase

Number of blades
3 blades
6 blades
9 blades

Angle of inclination of the blades

Power motor (c.v.)

F-200 Officially approved 200°C/2h

THT/CL: Long cased axial fans 400°C/2h, 300°C/2h and 200°C/2h with long casing, equipped with an inspection door

- 2=2900 r/min. 50 Hz
- 4=1400 r/min. 50 Hz
- 6=900 r/min. 50 Hz
- 8=750 r/min. 50 Hz
- 12=500 r/min. 50 Hz

- F-300 Officially approved, tested for 300°C/2h
- F-400 Officially approved 400°C/2h
- CAT3: With ATEX certification, Category 3 Ex II3G.

Technical characteristics

Model	Speed (r/min)	Maximum admissible current (A)			Power installed (kW)	Tilting angle blades (°)	Airflow maximum (m ³ /h)	Sound pressure level dB(A)	Approx. weight (Kg)	
		230V	400V	690V					Long	Short
THT-40-2T-1,5	2880	4.70	2.70		1.10	20	7050	76	33	31
THT-40-2/4T-1,5	2900 / 1450	2.90 / 1.10			1.10 / 0.25	20	7050 / 3525	76 / 61	34	32
THT-40-2T-2	2880	5.90	3.40		1.50	24	7950	77	35	33
THT-40-2/4T-2	2940 / 1460	4.40 / 1.40			1.50 / 0.37	24	7950 / 3975	77 / 62	35	33
THT-40-4T-0,75	1420	2.90	1.70		0.55	32	4800	64	32	29
THT-40-6T-0,75	930	3.30	1.90		0.55	32	3150	53	37	34
THT-40-6/12T-0,75	940 / 460	2.10 / 0.90			0.55 / 0.09	32	3150 / 1575	53 / 38	41	38
THT-45-2T-2	2880	5.90	3.40		1.50	16	9400	78	38	34
THT-45-2/4T-2	2940 / 1460	4.40 / 1.40			1.50 / 0.37	16	9400 / 4700	78 / 63	37	34
THT-45-2T-3	2900	8.70	5.00		2.20	22	11350	80	39	36
THT-45-2/4T-3	2930 / 1450	5.70 / 1.80			2.20 / 0.60	22	11350 / 5675	80 / 65	39	36
THT-45-4T-0,75	1420	2.90	1.70		0.55	36	7450	68	34	30
THT-45-6T-0,75	930	3.30	1.90		0.55	30	4450	55	38	35
THT-45-6/12T-0,75	940 / 460	2.10 / 0.90			0.55 / 0.09	30	4450 / 2225	55 / 40	42	39
THT-50-2T-4	2880	11.20	6.50		3.00	16	13900	82	49	42
THT-50-2/4T-4	2920 / 1440	6.70 / 2.00			3.00 / 0.80	16	13900 / 6950	82 / 67	51	44
THT-50-2T-5,5	2890	16.00	9.30		4.00	20	15900	83	65	57
THT-50-2/4T-6	2930 / 1450	10.00 / 3.20			4.50 / 1.30	20	15900 / 7950	83 / 68	67	60
THT-50-4T-1	1430	3.80	2.20		0.75	28	9750	69	37	33
THT-50-6T-0,75	930	3.30	1.90		0.55	32	7000	57	40	36
THT-50-6/12T-0,75	940 / 460	2.10 / 0.90			0.55 / 0.09	32	7000 / 3500	57 / 42	44	40
THT-56-2T-5,5	2890	16.00	9.30		4.00	16	18800	88	69	60
THT-56-2/4T-6	2930 / 1450	10.00 / 3.20			4.50 / 1.30	16	18800 / 9400	88 / 72	71	63
THT-56-2T-12	2950		19.20	11.09	9.00	30	27200	89	147	139
THT-56-2/4T-12	2920 / 1440	18.50 / 5.50			9.00 / 2.50	30	27200 / 13600	89 / 74	137	129
THT-56-4T-1	1430	3.80	2.20		0.75	22	11250	73	45	40
THT-56-4T-1,5	1420	4.70	2.70		1.10	30	13600	74	44	40
THT-56-4/8T-1,5	1440 / 710	2.90 / 1.40			1.10 / 0.25	30	13600 / 6800	74 / 59	48	43
THT-56-4T-2	1425	6.60	3.80		1.50	36	15050	75	48	43
THT-56-4/8T-2	1415 / 715	3.60 / 1.50			1.50 / 0.30	36	15050 / 7525	75 / 60	59	55
THT-56-6T-0,75	930	3.30	1.90		0.55	38	10150	62	44	39
THT-56-6/12T-0,75	940 / 460	2.10 / 0.90			0.55 / 0.09	38	10150 / 5075	62 / 47	48	43
THT-63-2T-12	2950		19.20	11.09	9.00	18	32300	90	161	143
THT-63-2/4T-12	2920 / 1440	18.50 / 5.50			9.00 / 2.50	18	32300 / 16150	90 / 75	151	133
THT-63-2T-22	2960		32.30	18.65	16.00	28	39950	91	188	170
THT-63-2/4T-22	2960 / 1480	32.30 / 8.90			16.00 / 4.00	28	39950 / 19975	91 / 76	188	170
THT-63-4T-1	1430	3.80	2.20		0.75	14	15200	73	49	43
THT-63-4T-1,5	1420	4.70	2.70		1.10	20	17800	74	51	45
THT-63-4/8T-1,5	1440 / 710	2.90 / 1.40			1.10 / 0.25	20	17800 / 8900	74 / 59	55	49
THT-63-4T-2	1425	6.60	3.80		1.50	24	19300	75	55	49
THT-63-4/8T-2	1415 / 715	3.60 / 1.50			1.50 / 0.30	24	19300 / 9650	75 / 60	70	60
THT-63-4T-3	1435	9.20	5.30		2.20	32	22150	76	64	54
THT-63-4/8T-3	1415 / 715	5.20 / 1.90			2.20 / 0.45	32	22150 / 11075	76 / 61	77	66
THT-63-4T-4	1430	11.40	6.60		3.00	38	24250	77	73	63
THT-63-4/8T-4	1420 / 705	6.90 / 2.30			3.00 / 0.60	38	24250 / 12125	77 / 62	86	77
THT-63-6T-0,75	930	3.30	1.90		0.55	28	13600	65	51	45
THT-63-6/12T-0,75	940 / 460	2.10 / 0.90			0.55 / 0.09	28	13600 / 6800	65 / 50	55	49
THT-63-6T-1	940	4.40	2.60		0.75	38	15900	66	54	48
THT-63-6/12T-1	935 / 430	2.50 / 1.03			0.75 / 0.15	38	15900 / 7950	66 / 51	61	55
THT-71-4T-1,5	1420	4.70	2.70		1.10	12	19500	78	58	52
THT-71-4/8T-1,5	1440 / 710	2.90 / 1.40			1.10 / 0.25	12	19500 / 9750	78 / 63	61	56
THT-71-4T-2	1425	6.60	3.80		1.50	14	20900	79	61	56
THT-71-4/8T-2	1415 / 715	3.60 / 1.50			1.50 / 0.30	14	20900 / 10450	79 / 64	76	67

Technical characteristics

Model	Speed (r/min)	Maximum admissible current (A)			Power installed (kW)	Tilting angle blades (°)	Airflow maximum (m³/h)	Sound pressure level dB(A)	Approx. weight (Kg)	
		230V	400V	690V					Long	Short
THT-71-4T-3	1435	9.20	5.30		2.20	22	25100	81	70	61
THT-71-4/8T-3	1415 / 715		5.20 / 1.90		2.20 / 0.45	22	25100 / 12550	81 / 66	82	74
THT-71-4T-4	1430	11.40	6.60		3.00	28	27500	82	79	70
THT-71-4/8T-4	1420 / 705		6.90 / 2.30		3.00 / 0.60	28	27500 / 13750	82 / 67	92	83
THT-71-6T-0,75	930	3.30	1.90		0.55	20	16100	67	57	52
THT-71-6/12T-0,75	940 / 460		2.10 / 0.90		0.55 / 0.09	20	16100 / 8050	67 / 52	61	56
THT-71-6T-1	940	4.40	2.60		0.75	26	17300	68	61	55
THT-71-6/12T-1	935 / 430		2.50 / 1.03		0.75 / 0.15	26	17300 / 8650	68 / 53	67	62
THT-71-6T-1,5	945	6.40	3.70		1.10	34	19950	69	69	61
THT-71-6/12T-1,5	940 / 450		3.30 / 1.20		1.10 / 0.18	34	19950 / 9975	69 / 54	77	69
THT-80-4T-3	1435	9.20	5.30		2.20	12	25450	82	79	69
THT-80-4/8T-3	1415 / 715		5.20 / 1.90		2.20 / 0.45	12	25450 / 12725	82 / 67	91	82
THT-80-4T-4	1430	11.40	6.60		3.00	16	30250	83	88	78
THT-80-4/8T-4	1420 / 705		6.90 / 2.30		3.00 / 0.60	16	30250 / 15125	83 / 68	101	92
THT-80-4T-5,5	1440		8.40	4.85	4.00	18	32750	84	94	85
THT-80-4/8T-5,5	1450 / 720		9.40 / 3.50		4.00 / 0.80	18	32750 / 16375	84 / 69	127	118
THT-80-6T-1,5	945	6.40	3.70		1.10	18	21450	72	78	69
THT-80-6/12T-1,5	940 / 450		3.30 / 1.20		1.10 / 0.18	18	21450 / 10725	72 / 57	86	77
THT-80-6T-2	945	7.40	4.30		1.50	26	25950	73	87	78
THT-80-6/12T-2	960 / 470		4.30 / 1.70		1.50 / 0.25	26	25950 / 12975	73 / 58	91	82
THT-80-6T-3	950	10.30	5.90		2.20	32	29950	74	94	84
THT-80-6/12T-3	940 / 470		5.60 / 2.20		2.20 / 0.37	32	29950 / 14975	74 / 59	100	91
THT-80-8T-0,75	700	3.60	2.10		0.55	20	17550	70	71	62
THT-80-8T-1	710	4.80	2.80		0.75	28	20650	71	78	69
THT-90-4T-4	1430	11.40	6.60		3.00	8	33600	87	110	93
THT-90-4/8T-4	1420 / 705		6.90 / 2.30		3.00 / 0.60	8	33600 / 16800	87 / 72	124	106
THT-90-4T-5,5	1440		8.40	4.85	4.00	12	38900	89	117	99
THT-90-4/8T-5,5	1450 / 720		9.40 / 3.50		4.00 / 0.80	12	38900 / 19450	89 / 74	150	132
THT-90-4T-7,5	1430		11.50	6.64	5.50	18	46150	91	143	126
THT-90-4/8T-7,5	1455 / 725		12.80 / 4.60		5.50 / 1.10	18	46150 / 23075	91 / 76	157	140
THT-90-4T-10	1460		17.70	10.22	7.50	22	50150	92	154	137
THT-90-4/8T-9	1455 / 725		15.50 / 5.50		6.70 / 1.50	22	50150 / 25075	92 / 77	157	140
THT-90-6T-2	945	7.40	4.30		1.50	16	28800	77	110	92
THT-90-6/12T-2	960 / 470		4.30 / 1.70		1.50 / 0.25	16	28800 / 14400	77 / 62	114	96
THT-90-6T-3	950	10.30	5.90		2.20	24	34000	78	116	99
THT-90-6/12T-3	940 / 470		5.60 / 2.20		2.20 / 0.37	24	34000 / 17000	78 / 63	123	105
THT-90-6T-4	945	15.00	8.70		3.00	30	38900	79	142	124
THT-90-6/12T-4	970 / 475		8.90 / 3.50		3.00 / 0.55	30	38900 / 19450	79 / 64	143	126
THT-90-8T-1	710	4.80	2.80		0.75	18	22900	71	100	84
THT-90-8T-2	700	9.00	5.20		1.50	30	29500	73	116	99
THT-90-8T-3	705	13.20	7.60		2.20	32	30850	74	134	116
THT-100-4T-7,5	1430		11.50	6.64	5.50	10	46850	92	151	131
THT-100-4/8T-7,5	1455 / 725		12.80 / 4.60		5.50 / 1.10	10	46850 / 23425	92 / 77	165	145
THT-100-4T-10	1460		17.70	10.22	7.50	16	57400	93	162	142
THT-100-4/8T-9	1455 / 725		15.50 / 5.50		6.70 / 1.50	14	54700 / 27350	93 / 78	165	145
THT-100-4T-15	1455		23.00	13.28	11.00	22	66300	94	215	195
THT-100-4/8T-15	1470 / 725		23.20 / 8.70		11.00 / 2.80	22	66300 / 33150	94 / 79	215	195
THT-100-4T-20	1460		29.00	16.74	15.00	28	76150	95	230	210
THT-100-4/8T-20	1470 / 725		31.70 / 11.80		15.00 / 3.80	28	76150 / 38075	95 / 80	230	210
THT-100-6T-3	950	10.30	5.90		2.20	16	37600	82	124	105
THT-100-6/12T-3	940 / 470		5.60 / 2.20		2.20 / 0.37	16	37600 / 18800	82 / 67	130	112
THT-100-6T-4	945	15.00	8.70		3.00	20	41150	83	150	130
THT-100-6/12T-4	970 / 475		8.90 / 3.50		3.00 / 0.55	20	41150 / 20575	83 / 68	151	131
THT-100-6T-5,5	970		11.00	6.35	4.00	26	47800	84	162	142
THT-100-6/12T-5,5	970 / 480		11.30 / 4.20		4.00 / 0.65	26	47800 / 23900	84 / 69	162	142

Technical characteristics

Model	Speed (r/min)	Maximum admissible current (A)			Power installed (kW)	Tilting angle blades (°)	Airflow maximum (m³/h)	Sound pressure level dB(A)	Approx. weight (Kg)	
		230V	400V	690V					Long	Short
THT-100-8T-2	700	9.00	5.20		1.50	22	32900	77	124	105
THT-100-8T-3	705	13.20	7.60		2.20	30	39400	77	142	122
THT-100-8T-4	710	15.60	9.00		3.00	32	40550	78	162	142
THT-125-4T/3-10	1460		17.70	10.22	7.50	8	58550	88	243	210
THT-125-4/8T/3-9	1455 / 725		15.50 / 5.50		6.70 / 1.50	8	58550 / 29275	88 / 68	243	210
THT-125-4T/3-15	1455		23.00	13.28	11.00	14	77750	89	294	266
THT-125-4/8T/3-15	1470 / 725		23.20 / 8.70		11.00 / 2.80	14	77750 / 38875	89 / 69	294	266
THT-125-4T/3-20	1460		29.00	16.74	15.00	18	91450	91	309	281
THT-125-4/8T/3-20	1470 / 725		31.70 / 11.80		15.00 / 3.80	18	91450 / 45725	91 / 71	309	281
THT-125-4T/3-25	1465		37.00	21.36	18.50	20	98350	91	377	334
THT-125-4T/3-30	1470		42.00	24.25	22.00	24	110350	92	391	348
THT-125-4/8T/3-27	1470 / 735		38.00 / 13.00		20.00 / 4.00	22	104400 / 52200	92 / 71	391	348
THT-125-4/8T/3-37	1475 / 735		51.00 / 20.60		27.00 / 6.00	28	120700 / 60350	93 / 72	472	429
THT-125-4T/3-40	1475		58.00	33.49	30.00	30	125000	93	472	429
THT-125-4/8T/3-40	1480 / 735		62.00 / 27.00		30.00 / 10.00	30	125000 / 62500	93 / 72	618	562
THT-125-4T/6-20	1460		29.00	16.74	15.00	10	78600	89	318	290
THT-125-4/8T/6-20	1470 / 725		31.70 / 11.80		15.00 / 3.80	10	78600 / 39300	89 / 68	318	290
THT-125-4/8T/6-22	1470 / 735		31.80 / 12.00		16.50 / 3.30	12	85600 / 42800	89 / 69	303	275
THT-125-4T/6-25	1465		37.00	21.36	18.50	14	92550	90	386	343
THT-125-4/8T/6-27	1470 / 735		38.00 / 13.00		20.00 / 4.00	16	98850 / 49425	90 / 69	400	357
THT-125-4T/6-30	1470		42.00	24.25	22.00	16	98850	90	400	357
THT-125-4/8T/6-37	1475 / 735		51.00 / 20.60		27.00 / 6.00	20	110900 / 55450	90 / 70	481	437
THT-125-4T/6-40	1475		58.00	33.49	30.00	22	117450	92	481	437
THT-125-4/8T/6-40	1480 / 735		62.00 / 27.00		30.00 / 10.00	22	117450 / 58725	92 / 71	627	571
THT-125-4T/6-50	1480		73.00	42.15	37.00	26	131050	93	529	473
THT-125-4T/9-25	1465		37.00	21.36	18.50	10	79650	88	395	352
THT-125-4/8T/9-22	1470 / 735		31.80 / 12.00		16.50 / 3.30	8	71150 / 35575	88 / 69	312	284
THT-125-4T/9-30	1470		42.00	24.25	22.00	12	88300	89	409	366
THT-125-4/8T/9-27	1470 / 735		38.00 / 13.00		20.00 / 4.00	12	88300 / 44150	89 / 70	409	366
THT-125-4/8T/9-37	1475 / 735		51.00 / 20.60		27.00 / 6.00	16	104050 / 52025	90 / 70	490	446
THT-125-4T/9-40	1475		58.00	33.49	30.00	16	104050	91	490	446
THT-125-4/8T/9-40	1480 / 735		62.00 / 27.00		30.00 / 10.00	16	104050 / 52025	91 / 71	636	580
THT-125-4T/9-50	1480		73.00	42.15	37.00	20	118400	93	538	482
THT-125-6T/3-4	945	15.00	8.70		3.00	12	46750	79	230	197
THT-125-6/12T/3-4	970 / 475		8.90 / 3.50		3.00 / 0.55	12	46750 / 23375	79 / 64	232	199
THT-125-6T/3-5,5	970		11.00	6.35	4.00	16	55400	80	242	209
THT-125-6/12T/3-5,5	970 / 480		11.30 / 4.20		4.00 / 0.65	16	55400 / 27700	80 / 65	243	210
THT-125-6T/3-7,5	970		14.00	8.08	5.50	22	68400	81	249	216
THT-125-6/12T/3-7,5	970 / 480		13.70 / 5.60		5.50 / 1.00	22	68400 / 34200	81 / 66	263	230
THT-125-6T/3-10	960		18.60	10.74	7.50	28	79150	83	274	246
THT-125-6/12T/3-10	970 / 480		19.00 / 8.00		7.50 / 1.40	28	79150 / 39575	83 / 68	294	266
THT-125-6T/3-15	955		26.00	15.01	11.00	34	87150	84	304	276
THT-125-6/12T/3-15	970 / 470		28.50 / 13.00		11.00 / 2.00	34	87150 / 43575	84 / 69	309	281
THT-125-6T/3-20	950		35.50	20.50	15.00	38	91650	85	377	334
THT-125-6/12T/3-24	970 / 480		36.00 / 14.50		17.50 / 3.50	38	91650 / 45825	85 / 70	472	429
THT-125-6T/6-5,5	970		11.00	6.35	4.00	10	51500	77	251	218
THT-125-6/12T/6-5,5	970 / 480		11.30 / 4.20		4.00 / 0.65	10	51500 / 25750	77 / 62	252	219
THT-125-6T/6-7,5	970		14.00	8.08	5.50	14	60650	77	258	225
THT-125-6/12T/6-7,5	970 / 480		13.70 / 5.60		5.50 / 1.00	14	60650 / 30325	77 / 62	272	239
THT-125-6T/6-10	960		18.60	10.74	7.50	20	72650	79	283	255
THT-125-6/12T/6-10	970 / 480		19.00 / 8.00		7.50 / 1.40	20	72650 / 36325	79 / 64	303	275
THT-125-6T/6-15	955		26.00	15.01	11.00	26	85850	81	313	285
THT-125-6/12T/6-15	970 / 470		28.50 / 13.00		11.00 / 2.00	26	85850 / 42925	81 / 66	318	290
THT-125-6T/6-20	950		35.50	20.50	15.00	30	92850	82	386	343
THT-125-6/12T/6-24	970 / 480		36.00 / 14.50		17.50 / 3.50	34	99650 / 49825	82 / 67	481	437

Technical characteristics

Model	Speed (r/min)	Maximum admissible current (A)			Power installed (kW)	Tilting angle blades (°)	Airflow maximum (m ³ /h)	Sound pressure level dB(A)	Approx. weight (Kg)	
		230V	400V	690V					Long	Short
THT-125-6T/9-10	960		18.60	10.74	7.50	14	63500	78	292	264
THT-125-6/12T/9-10	970 / 480		19.00 / 8.00		7.50 / 1.40	14	63500 / 31750	78 / 63	312	284
THT-125-6T/9-15	955		26.00	15.01	11.00	20	77550	81	322	294
THT-125-6/12T/9-15	970 / 470		28.50 / 13.00		11.00 / 2.00	20	77550 / 38775	81 / 66	327	299
THT-125-6T/9-20	950		35.50	20.50	15.00	26	92950	84	395	352
THT-125-6/12T/9-24	970 / 480		36.00 / 14.50		17.50 / 3.50	30	98500 / 49250	84 / 69	490	446
THT-140-6T/3-5,5	970		11.00	6.35	4.00	8	51300	83	279	242
THT-140-6T/3-7,5	970		14.00	8.08	5.50	14	68150	84	287	250
THT-140-6T/3-10	960		18.60	10.74	7.50	18	80200	85	339	300
THT-140-6T/3-15	955		26.00	15.01	11.00	24	96700	86	356	317
THT-140-6T/3-20	950		35.50	20.50	15.00	30	109600	88	436	386
THT-140-6T/6-7,5	970		14.00	8.08	5.50	8	62800	84	297	260
THT-140-6T/6-10	960		18.60	10.74	7.50	10	68900	85	349	310
THT-140-6T/6-15	955		26.00	15.01	11.00	16	86650	86	366	327
THT-140-6T/6-20	950		35.50	20.50	15.00	22	102950	87	445	396
THT-140-6T/6-25	975		34.40	19.86	18.50	24	108750	88	497	448
THT-140-6T/6-30	975		41.40	23.90	22.00	28	119050	89	506	457
THT-140-6T/9-10	960		18.60	10.74	7.50	8	62350	84	358	319
THT-140-6T/9-15	955		26.00	15.01	11.00	12	77400	86	375	336
THT-140-6T/9-20	950		35.50	20.50	15.00	16	91200	87	455	405
THT-140-6T/9-25	975		34.40	19.86	18.50	20	103800	88	506	458
THT-140-6T/9-30	975		41.40	23.90	22.00	22	111000	89	515	467
THT-140-6T/9-40	985		54.20	31.29	30.00	28	128800	91	673	611
THT-140-6T/9-50	980		66.40	38.34	37.00	32	135750	92	751	696
THT-140-8T/3-3	705	13.20	7.60		2.20	12	47400	78	279	242
THT-140-8T/3-4	710	15.60	9.00		3.00	16	56200	78	287	250
THT-140-8T/3-5,5	710		13.00	7.51	4.00	20	65350	79	337	298
THT-140-8T/3-7,5	710		15.10	8.72	5.50	26	77400	81	346	307
THT-140-8T/3-10	715		20.60	11.89	7.50	32	85900	82	357	318
THT-140-8T/6-3	705	13.20	7.60		2.20	8	47600	78	289	252
THT-140-8T/6-4	710	15.60	9.00		3.00	10	52250	79	297	260
THT-140-8T/6-5,5	710		13.00	7.51	4.00	14	61500	80	347	308
THT-140-8T/6-7,5	710		15.10	8.72	5.50	18	69550	81	356	317
THT-140-8T/6-10	715		20.60	11.89	7.50	24	82700	82	367	328
THT-140-8T/6-15	725		21.70	12.53	11.00	30	94150	83	453	404
THT-140-8T/9-4	710	15.60	9.00		3.00	8	47250	79	306	269
THT-140-8T/9-5,5	710		13.00	7.51	4.00	10	52950	79	356	317
THT-140-8T/9-7,5	710		15.10	8.72	5.50	14	64400	81	365	326
THT-140-8T/9-10	715		20.60	11.89	7.50	18	73900	82	376	337
THT-140-8T/9-15	725		21.70	12.53	11.00	26	94300	83	463	413
THT-140-8T/9-20	725		32.90	18.99	15.00	32	102900	86	516	468
THT-160-6T/3-10	960		18.60	10.74	7.50	8	76600	83	412	358
THT-160-6T/3-15	955		26.00	15.01	11.00	12	93350	85	429	375
THT-160-6T/3-20	950		35.50	20.50	15.00	18	119700	86	522	453
THT-160-6T/3-25	975		34.40	19.86	18.50	22	136600	87	574	504
THT-160-6T/3-30	975		41.40	23.90	22.00	24	144550	89	583	513
THT-160-6T/6-15	955		26.00	15.01	11.00	8	93750	85	440	386
THT-160-6T/6-20	950		35.50	20.50	15.00	12	112000	86	532	463
THT-160-6T/6-25	975		34.40	19.86	18.50	14	121100	87	584	515
THT-160-6T/6-30	975		41.40	23.90	22.00	16	129350	88	593	524
THT-160-6T/6-40	985		54.20	31.29	30.00	22	153700	89	768	669
THT-160-6T/6-50	980		66.40	38.34	37.00	26	170800	91	842	757
THT-160-6T/9-15	955		26.00	15.01	11.00	8	93100	85	450	396
THT-160-6T/9-20	950		35.50	20.50	15.00	8	93100	86	542	473
THT-160-6T/9-25	975		34.40	19.86	18.50	10	104250	87	594	525

Technical characteristics

Model	Speed (r/min)	Maximum admissible current (A)			Power installed (kW)	Tilting angle blades (°)	Airflow maximum (m³/h)	Sound pressure level dB(A)	Approx. weight (Kg)	
		230V	400V	690V					Long	Short
THT-160-6T/9-30	975		41.40	23.90	22.00	14	126800	88	603	534
THT-160-6T/9-40	985		54.20	31.29	30.00	18	145500	89	778	679
THT-160-6T/9-50	980		66.40	38.34	37.00	20	154950	90	852	768
THT-160-6T/9-60	985		84.50	48.79	45.00	24	176750	91	1067	968
THT-160-6T/9-75	985		100.00	57.74	55.00	28	192300	92	1112	1013
THT-160-8T/3-4	710	15.60	9.00		3.00	8	58050	77	356	304
THT-160-8T/3-5,5	710		13.00	7.51	4.00	12	70750	79	410	356
THT-160-8T/3-7,5	710		15.10	8.72	5.50	16	83900	80	419	365
THT-160-8T/3-10	715		20.60	11.89	7.50	20	97550	81	430	376
THT-160-8T/3-15	725		21.70	12.53	11.00	26	115550	83	530	461
THT-160-8T/6-5,5	710		13.00	7.51	4.00	8	71050	77	421	367
THT-160-8T/6-7,5	710		15.10	8.72	5.50	10	77950	79	430	376
THT-160-8T/6-10	715		20.60	11.89	7.50	14	91800	80	441	387
THT-160-8T/6-15	725		21.70	12.53	11.00	18	103800	82	540	471
THT-160-8T/6-20	725		32.90	18.99	15.00	24	123050	83	594	525
THT-160-8T/6-25	730		34.90	20.15	18.50	28	134700	84	741	642
THT-160-8T/9-7,5	710		15.10	8.72	5.50	8	70550	79	440	386
THT-160-8T/9-10	715		20.60	11.89	7.50	10	79000	80	451	397
THT-160-8T/9-15	725		21.70	12.53	11.00	14	96100	82	550	481
THT-160-8T/9-20	725		32.90	18.99	15.00	18	110300	83	604	535
THT-160-8T/9-25	730		34.90	20.15	18.50	22	125600	84	751	652
THT-160-8T/9-30	730		41.10	23.73	22.00	26	140750	85	776	677
THT-160-8T/9-40	730		56.30	32.50	30.00	32	153550	86	837	753

Acoustic features

The specified values are determined according to free field measurements of pressure and sound levels in dB(A) at an equivalent distance of twice the fan's span plus the impeller's diameter, with a minimum of 1.5 m.

Sound power Lw(A) spectrum in dB(A) via frequency band in Hz.

Model	63	125	250	500	1000	2000	4000	8000	Model	63	125	250	500	1000	2000	4000	8000
40-2-1.5	48	69	76	81	84	80	73	62	63-6-0.75	42	60	68	73	75	72	65	56
40-2-2	49	70	77	82	85	81	74	63	63-6-1	43	62	70	75	77	74	67	57
40-4-0.75	36	57	64	69	72	68	61	50	63-8-1.5	33	53	61	66	68	65	58	50
40-4-1.5	33	54	61	66	69	65	58	47	63-8-2	37	53	61	66	68	65	58	51
40-4-2	34	55	62	67	70	66	59	48	63-8-3	38	55	63	68	70	67	62	52
40-6	25	46	53	58	61	57	50	39	63-8-4	39	56	64	69	71	68	63	53
40-12	10	31	38	43	46	42	35	24	63-12-0.75	27	43	51	56	58	55	48	37
45-2-2	50	71	78	83	86	82	75	64	63-12-1	28	45	53	58	60	57	50	42
45-2-3	52	73	80	85	88	84	77	66	71-4-1.5	54	74	82	87	89	86	79	69
45-4-0.75	40	61	68	73	76	72	65	54	71-4-2	53	73	81	86	88	85	78	70
45-4-2	35	56	63	68	71	67	60	49	71-4-3	58	72	80	85	87	84	77	71
45-4-3	37	58	65	70	73	69	62	51	71-4-4	59	73	81	86	88	85	78	72
45-6	27	48	55	60	63	59	52	41	71-6-0.75	44	63	72	74	76	73	66	55
45-12	12	33	40	45	48	44	37	26	71-6-1	45	65	73	75	77	74	67	56
50-2-4	57	77	85	90	92	89	82	71	71-6-1.5	46	66	71	76	78	75	68	57
50-2-5.5	58	78	86	91	93	90	83	72	71-8-1.5	38	58	66	71	73	70	63	54
50-2-6	58	78	86	91	93	90	83	72	71-8-2	38	58	66	71	73	70	63	55
50-4-1	44	64	72	77	79	76	69	58	71-8-3	43	57	65	70	72	69	62	56
50-4-4	42	62	70	75	77	74	67	56	71-8-4	44	58	66	71	73	70	63	57
50-4-6	43	63	71	76	78	75	68	57	71-12-0.75	29	44	52	57	59	56	49	38
50-6	32	52	60	65	67	64	57	46	71-12-1	30	46	54	59	61	58	51	40
50-12	17	37	45	50	52	49	42	31	71-12-1.5	31	46	54	59	61	58	51	40
50-2-5.5	63	83	91	96	98	95	88	77	80-4-3	57	77	85	90	92	89	82	73
56-2-6	63	83	91	96	98	95	88	77	80-4-4	56	76	84	89	91	88	81	74
56-2-12	64	84	92	97	99	96	89	78	80-4-5.5	56	76	84	89	91	88	81	70
56-4-1	48	68	76	81	83	80	73	62	80-6-1.5	49	66	74	79	81	78	71	60
56-4-1.5	49	69	77	82	84	81	74	63	80-6-2	50	67	75	80	82	79	72	61
56-4-2	50	70	78	83	85	82	75	64	80-6-3	51	68	76	81	83	80	73	62
56-4-6	48	68	76	81	83	80	73	62	80-8-0.75	47	60	68	73	75	72	65	54
56-4-12	49	69	77	82	84	81	74	63	80-8-1	48	61	69	74	76	73	66	55
56-6	37	57	65	70	72	69	62	51	80-8-3	42	62	70	75	77	74	67	58
56-8-1.5	34	54	62	67	69	66	59	48	80-8-4	41	61	69	74	76	73	66	59
56-8-2	35	55	63	68	70	67	60	49	80-8-5.5	40	60	68	73	75	72	65	59
56-12	22	42	50	55	57	54	47	36	80-12-1.5	34	49	57	62	64	61	54	43
63-2-12	67	87	95	100	102	99	92	81	80-12-2	35	50	58	63	65	62	55	44
63-2-22	68	88	96	101	103	100	93	82	80-12-3	36	51	59	64	66	63	56	45
63-4-1	50	70	78	83	85	82	75	64	90-4-4	61	82	89	94	97	93	86	79
63-4-1.5	48	68	76	81	83	80	73	65	90-4-5.5	60	81	88	93	96	92	85	74
63-4-2	52	68	76	81	83	80	73	66	90-4-7.5	59	80	87	92	95	91	84	73
63-4-3	53	70	78	83	85	82	77	67	90-4-9	58	79	86	91	94	90	83	72
63-4-4	54	71	79	84	86	83	78	68	90-4-10	58	79	86	91	94	90	83	72
63-4-12	52	72	80	85	87	84	77	66	90-6-2	49	70	77	82	85	81	74	63
63-4-22	53	73	81	86	88	85	78	67	90-6-3	56	70	77	82	85	81	74	63

Acoustic features

Sound power Lw(A) spectrum in dB(A) via frequency band in Hz.

90-6-4	57	72	79	84	87	83	76	65	125-4/9-40	69	77	94	100	101	96	91	87
90-8-1	42	63	70	75	78	74	67	56	125-4/9-50	71	79	96	102	103	98	93	89
90-8-2	51	66	73	78	81	77	70	59	125-6/9-10	58	68	83	87	86	85	74	70
90-8-3	52	66	73	78	81	77	70	59	125-6/9-15	61	71	86	90	89	88	77	73
90-8-4	46	67	74	79	82	78	71	64	125-6/9-20	64	74	89	93	92	91	80	76
90-8-5.5	45	66	73	78	81	77	70	59	125-6/9-24	64	74	89	93	92	91	80	76
90-8-7.5	43	64	71	76	79	75	68	57	125-8/9-22	47	55	72	78	79	74	69	65
90-8-9	43	64	71	76	79	75	68	57	125-8/9-27	48	56	73	79	80	75	70	66
90-12-2	32	53	60	65	68	64	57	46	125-8/9-37	48	56	73	79	80	75	70	66
90-12-3	41	53	60	65	68	64	57	46	125-8/9-40	49	57	74	80	81	76	71	67
90-12-4	42	55	62	67	70	66	59	48	125-12/9-10	43	53	68	72	71	70	59	55
100-4-7.5	64	84	92	97	99	96	89	78	125-12/9-15	46	56	71	75	74	73	62	58
100-4-9	63	83	91	96	98	95	88	77	125-12/9-24	49	59	74	78	77	76	65	61
100-4-10	62	82	90	95	97	94	87	76	140-6/3-5.5	69	79	87	92	91	90	77	77
100-4-15	61	81	89	94	96	93	86	75	140-6/3-7.5	70	80	88	93	92	91	78	78
100-4-20	63	83	91	96	98	95	88	77	140-6/3-10	71	81	89	94	93	92	79	79
100-6-3	61	72	80	85	87	84	77	66	140-6/3-15	72	82	90	95	94	93	80	80
100-6-4	64	72	80	85	87	84	77	66	140-6/3-20	74	84	92	97	96	95	82	82
100-6-5.5	64	73	81	86	88	85	78	67	140-6/6-7.5	68	83	92	94	91	85	77	73
100-8-2	56	66	74	79	81	78	71	60	140-6/6-10	69	84	93	95	92	86	78	74
100-8-3	57	68	76	81	83	80	73	62	140-6/6-15	70	85	94	96	93	87	79	75
100-8-4	58	68	76	81	83	80	73	62	140-6/6-20	71	86	95	97	94	88	80	76
100-8-7.5	49	69	77	82	84	81	74	63	140-6/6-25	72	87	96	98	95	89	81	77
100-8-9	48	68	76	81	83	80	73	62	140-6/6-30	73	88	97	99	96	90	82	78
100-8-15	46	66	74	79	81	78	71	60	140-6/9-10	66	84	93	92	91	87	78	73
100-8-20	47	67	75	80	82	79	72	61	140-6/9-15	68	86	95	94	93	89	80	75
100-12-3	46	55	63	68	70	67	60	49	140-6/9-20	69	87	96	95	94	90	81	76
100-12-4	48	55	63	68	70	67	60	49	140-6/9-25	70	88	97	96	95	91	82	77
100-12-5.5	49	56	64	69	71	68	61	50	140-6/9-30	71	89	98	97	96	92	83	78
125-4/3-9	70	76	88	98	98	94	86	82	140-6/9-40	73	91	100	99	98	94	85	80
125-4/3-10	70	76	88	98	98	94	86	82	140-6/9-50	74	92	101	100	99	95	86	81
125-4/3-15	71	77	89	99	99	95	87	83	140-8/3-3	64	74	82	87	86	85	72	67
125-4/3-20	73	79	91	101	101	97	89	85	140-8/3-4	64	74	82	87	86	85	72	67
125-4/3-25	73	79	91	101	101	97	89	85	140-8/3-5.5	65	75	83	88	87	86	73	68
125-4/3-27	74	80	92	102	102	98	90	86	140-8/3-7.5	67	77	85	90	89	88	75	70
125-4/3-30	74	80	92	102	102	98	90	86	140-8/3-10	68	78	86	91	90	89	76	71
125-4/3-37	75	81	93	103	103	99	91	87	140-8/6-3	63	75	84	88	86	80	70	67
125-4/3-40	75	81	93	103	103	99	91	87	140-8/6-4	64	76	85	89	87	81	71	68
125-6/3-5.5	66	74	86	90	88	83	74	70	140-8/6-5.5	65	77	86	90	88	82	72	69
125-6/3-7.5	67	75	87	91	89	84	75	71	140-8/6-7.5	66	78	87	91	89	83	73	70
125-6/3-10	69	77	89	93	91	86	77	73	140-8/6-10	67	79	88	92	90	84	74	71
125-6/3-15	70	78	90	94	92	87	78	74	140-8/6-15	68	80	89	93	91	85	75	72
125-6/3-20	71	79	91	95	93	88	79	75	140-8/9-4	62	73	84	89	87	83	73	68
125-6/3-24	71	79	91	95	93	88	79	75	140-8/9-5.5	62	73	84	89	87	83	73	68
125-8/3-9	50	56	68	78	78	74	66	62	140-8/9-7.5	64	75	86	91	89	85	75	70
125-8/3-15	51	57	69	79	79	75	67	63	140-8/9-10	65	76	87	92	90	86	76	71
125-8/3-20	53	59	71	81	81	77	69	65	140-8/9-15	66	77	88	93	91	87	77	72
125-8/3-27	53	59	71	81	81	77	69	65	140-8/9-20	69	80	91	96	94	90	80	75
125-8/3-37	54	60	72	82	82	78	70	66	160-6/3-10	69	79	87	92	91	90	77	72
125-8/3-40	54	60	72	82	82	78	70	66	160-6/3-15	71	81	89	94	93	92	79	74
125-6/3-4	65	73	85	89	87	82	73	69	160-6/3-20	72	82	90	95	94	93	80	75
125-12/3-4	50	58	70	74	72	67	58	54	160-6/3-25	73	83	91	96	95	94	81	76
125-12/3-5.5	51	59	71	75	73	68	59	55	160-6/3-30	75	85	93	98	97	96	83	78
125-12/3-7.5	52	60	72	76	74	69	60	56	160-6/6-15	69	84	93	95	92	86	78	74
125-12/3-10	54	62	74	78	76	71	62	58	160-6/6-20	70	85	94	96	93	87	79	75
125-12/3-15	55	63	75	79	77	72	63	59	160-6/6-25	71	86	95	97	94	88	80	76
125-12/3-24	56	64	76	80	78	73	64	60	160-6/6-30	72	87	96	98	95	89	81	77
125-4/6-20	67	75	91	98	100	95	89	85	160-6/6-40	73	88	97	99	96	90	82	78
125-4/6-22	67	75	91	98	100	95	89	85	160-6/6-50	75	90	99	101	98	92	84	80
125-4/6-25	68	76	92	99	101	96	90	86	160-6/9-15	67	85	94	93	92	88	79	74
125-4/6-27	68	76	92	99	101	96	90	86	160-6/9-20	68	86	95	94	93	89	80	75
125-4/6-30	68	76	92	99	101	96	90	86	160-6/9-25	69	87	96	95	94	90	81	76
125-4/6-37	68	76	92	99	101	96	90	86	160-6/9-30	70	88	97	96	95	91	82	77
125-4/6-40	70	78	94	101	103	98	92	88	160-6/9-40	71	89	98	97	96	92	83	78
125-4/6-50	71	79	95	102	104	99	93	89	160-6/9-50	72	90	99	98	97	93	84	79
125-6/6-5.5	60	69	82	85	86	83	72	68	160-6/9-60	73	91	100	99	98	94	85	80
125-6/6-7.5	60	69	82	85	86	83	72	68	160-6/9-75	74	92	101	100	99	95	86	81
125-6/6-10	62	71	84	87	88	85	74	70	160-8/3-4	63	73	81	86	85	84	71	66
125-6/6-15	64	73	86	89	90	87	76	72	160-8/3-5.5	65	75	83	88	87	86	73	68
125-6/6-20	65	74	87	90	91	88	77	73	160-8/3-7.5	66	76	84	89	88	87	74	69
125-6/6-24	65	74	87	90	91	88	77	73	160-8/3-10	67	77	85	90	89	88	75	70
125-8/6-20	46	54	70	77	79	74	68	64	160-8/3-15	69	79	87	92	91	90	77	72
125-8/6-22	47	55	71	78	80	75	69	65	160-8/6-5.5	61	76	85	87	84	78	70	66
125-8/6-27	47	55	71	78	80	75	69	65	160-8/6-7.5	63	78	87	89	86	80	72	68
125-8/6-37	48	56	72	79	81	76	70	66	160-8/6-10	64	79	88	90	87	81	73	69
125-8/6-40	49	57	73	80	82	77	71	67	160-8/6-15	66	81	90	92	89	83	75	71
125-12/6-5.5	45	54	67	70	71	68	57	53	160-8/6-20	67	82	91	93	90	84	76	72
125-12/6-7.5	45	54	67	70	71	68	57	53	160-8/6-25	68	83	92	94	91	85	77	73
125-12/6-10	47	56	69	72	73	70	59	55	160-8/9-7.5	61	79	88	87	86	82	73	68
125-12/6-15	49	58	71	74	75	72	61	57	160-8/9-10	62	80	89	88	87	83	74	69
125-12/6-24	50	59	72	75	76	73	62	58	160-8/9-15	64	82	91	90	89	85	76	71
125-4/9-22	66	74	91	97	98	93	88	84	160-8/9-20	65	83	92	91	90	86	77	72
125-4/9-25	66	74	91	97	98	93	88	84	160-8/9-25	66	84	93	92	91	87		

Dimensions in mm

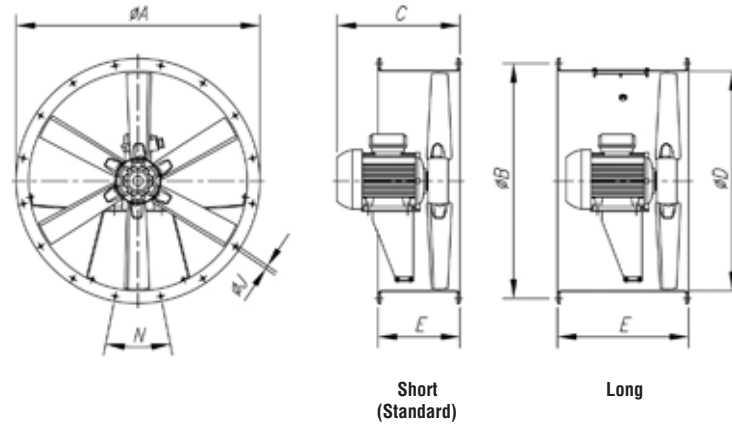

Model	ØA	ØB	C (consult motor size according to power)																E			ØJ	N
			80	90S	90L	100	112	132S	132M	160M	160L	180M	180L	200L	225	250	280	ØD	Short	Long			
THT-40	490	450	348	364	389	-	-	-	-	-	-	-	-	-	-	-	-	410	250	400	12	8x45°	
THT-45	540	500	348	364	389	-	-	-	-	-	-	-	-	-	-	-	-	460	250	400	12	8x45°	
THT-50	600	560	339	364	389	419	-	-	-	-	-	-	-	-	-	-	-	514	250	400	12	12x30°	
THT-50	600	560	-	-	-	-	438	-	-	-	-	-	-	-	-	-	-	514	250	500	12	12x30°	
THT-56	660	620	275	364	389	-	-	-	-	-	-	-	-	-	-	-	-	560	250	400	12	12x30°	
THT-56	660	620	-	-	-	416	432	480	518	-	-	-	-	-	-	-	-	560	250	500	12	12x30°	
THT-56	660	620	-	-	-	-	-	-	-	620	-	-	-	-	-	-	-	560	250	650	12	12x30°	
THT-63	730	690	339	359	389	-	-	-	-	-	-	-	-	-	-	-	-	640	250	400	12	12x30°	
THT-63	730	690	-	-	-	420	437	-	-	-	-	-	-	-	-	-	-	640	250	500	12	12x30°	
THT-63	730	690	-	-	-	-	-	539	577	-	-	-	-	-	-	-	-	640	250	650	12	12x30°	
THT-63	730	690	-	-	-	-	-	-	-	630	674	-	-	-	-	-	-	640	350	650	12	12x30°	
THT-71	810	770	366	379	404	-	-	-	-	-	-	-	-	-	-	-	-	710	300	430	12	16x22°30'	
THT-71	810	770	-	-	-	438	433	-	-	-	-	-	-	-	-	-	-	710	300	500	12	16x22°30'	
THT-80	900	860	-	-	422	456	472	-	-	-	-	-	-	-	-	-	-	800	300	500	12	16x22°30'	
THT-80	900	860	-	-	-	-	-	515	-	-	-	-	-	-	-	-	-	800	300	600	12	16x22°30'	
THT-90	1015	970	-	-	-	466	482	525	565	-	-	-	-	-	-	-	-	900	350	600	15	16x22°30'	
THT-100	1115	1070	-	-	-	-	482	525	565	-	-	-	-	-	-	-	-	1000	350	600	15	16x22°30'	
THT-100	1115	1070	-	-	-	-	-	-	-	695	695	-	-	-	-	-	-	1000	450	700	15	16x22°30'	
THT-125	1365	1320	-	-	-	-	-	561	601	-	-	-	-	-	-	-	-	1250	500	700	15	20x18°	
THT-125	1365	1320	-	-	-	-	-	-	-	695	695	-	-	-	-	-	-	1250	500	700	15	20x18°	
THT-125	1365	1320	-	-	-	-	-	-	-	-	-	740	740	860	-	-	-	1250	500	900	15	20x18°	
THT-125	1365	1320	-	-	-	-	-	-	-	-	-	-	-	-	907	-	-	1250	500	1000	15	20x18°	
THT-125	1365	1320	-	-	-	-	-	-	-	-	-	-	-	-	-	987	-	1250	600	1000	15	20x18°	
THT-125	1365	1320	-	-	-	-	-	-	-	-	-	-	-	-	-	-	1077	1250	600	1200	15	20x18°	
THT-140	1515	1470	-	-	-	-	-	-	570	-	-	-	-	-	-	-	-	1400	400	650	15	20x18°	
THT-140	1515	1470	-	-	-	-	-	-	-	-	700	-	-	-	-	-	-	1400	450	700	15	20x18°	
THT-140	1515	1470	-	-	-	-	-	-	-	-	-	-	765	-	-	-	-	1400	550	900	15	20x18°	
THT-140	1515	1470	-	-	-	-	-	-	-	-	-	-	-	825	-	-	-	1400	550	900	15	20x18°	
THT-140	1515	1470	-	-	-	-	-	-	-	-	-	-	-	-	910	-	-	1400	550	1000	15	20x18°	
THT-140	1515	1470	-	-	-	-	-	-	-	-	-	-	-	-	-	985	-	1400	600	1000	15	20x18°	
THT-160	1735	1680	-	-	-	-	-	-	570	-	-	-	-	-	-	-	-	1600	400	650	19	24x15°	
THT-160	1735	1680	-	-	-	-	-	-	-	-	700	-	-	-	-	-	-	1600	450	700	19	24x15°	
THT-160	1735	1680	-	-	-	-	-	-	-	-	-	-	765	-	-	-	-	1600	550	900	19	24x15°	
THT-160	1735	1680	-	-	-	-	-	-	-	-	-	-	-	825	-	-	-	1600	550	1000	19	24x15°	
THT-160	1735	1680	-	-	-	-	-	-	-	-	-	-	-	-	910	-	-	1600	550	1000	19	24x15°	
THT-160	1735	1680	-	-	-	-	-	-	-	-	-	-	-	-	-	985	-	1600	600	1000	19	24x15°	
THT-160	1735	1680	-	-	-	-	-	-	-	-	-	-	-	-	-	-	1190	1600	700	1000	19	24x15°	

Motor build sizes depending on power (one-speed)

	CV																			
	0,75	1	1,5	2	3	4	5,5	7,5	10	12	15	20	22	25	30	40	50	60	75	100
2T (3000 r/min)	80	80	80	90S	90L	100LB	112M	132S	132S	132MA	160M	160M	160L	180M	180L	200L	225S/M	225S/M	250S/M	280S/M
4T (1500 r/min)	90S	90S	90S	90L	100LA	100LB	112M	132S	132M	-	160M	160L	-	180M	180L	200L	225S/M	225S/M	250S/M	280S/M
6T (1000 r/min)	90S	90S	90L	100L	112M	132S	132MA	132MB	160M	-	160L	180L	-	200MLA	200MLB	225SMB	250S/M	280S/M	280S/M	-
8T (750 r/min)	90L	100LA	100L	112M	132S	132M	160MA	160M	160L	-	180L	200MLA	-	225SMA	225SMB	250SMA	280S/M	280S/M	-	-

Motor build sizes depending on power (two-speed)

	CV																					
	0,75	1	1,5	2	3	4	5,5	6	7,5	8	10	12	15	18	20	22	24	27	37	38	40	
2/4(3000/1500 r/min)	-	-	90S	90S	90L	100L	-	112M	-	-	132M	-	160MA	-	160M	-	160L	-	-	-	-	
4/8(1500/750 r/min)	-	-	90S	100L	100LA	100LC	132S	-	132S	132S	-	132M	-	160M	-	160L	180M	180M	180L	200MLA	200L	225S/M
6/12(1000/500 r/min)	90L	100L	100LB	112M	112M	132MC	160M	160M	160LB	160LB	-	160LB	-	200MLC	160L	200M	-	250SMB	225S/M	-	225S/M	-

Characteristic curves

See characteristic curves on page 33.

CJTHT/PLUS



400°C/2h, 300°C/2h and 200°C/2h axial extraction units with built-in noise reducer



Extraction units with soundproofed box to work inside fire danger zones at 400°C/2h and noise reducer, with built-in central core.

Fan:

- Galvanised sheet steel structure with thermal insulation and soundproofing.
- Turnable cast aluminium impellers.
- Noise reducer with sound-absorbing material, especially tested to reduce noise considerably. Units suitable for working in both horizontal and vertical positions. Approval according to Standard EN-12101-3-2002, certificate no.: 0370-CPD-0312
- Airflow direction from motor to impeller



Highly-efficient built-in noise reducer.

Motor:

- Class H motors, ongoing use S1 and emergency use S2, with ball bearings, IP55 protection, and one- or two- speed depending on the model.
- Three-phase 230/400V.-50Hz. (up to 4CV.) and 400/690V.-50Hz. (power over 4CV.)
- Max. temperature of air for transport: S1 Service -20°C+ 40°C for ongoing use, S2 Service 200°C/2h, 300°C/2h, 400°C/2h

Finish:

- Anticorrosive galvanized sheet steel.

On request:

- 100% reversible impellers.

Order code

CJTHT/PLUS — 56 — 4T — 2 — F-400

CJTHT/PLUS: 400°C/2h, 300°C/2h y 200°C/2h axial extraction units with built-in noise reducer

Impeller diameter in cm.

Number of motor poles
 2=2900 r/min. 50 Hz
 4=1400 r/min. 50 Hz
 6=900 r/min. 50 Hz
 8=750 r/min. 50 Hz
 12=500 r/min. 50 Hz

T=Three-phase

Power motor (c.v.)

F-200 Officially approved 200°C/2h
 F-300 Officially approved, tested for 300°C/2h
 F-400 Officially approved 400°C/2h

Technical characteristics

Model	Speed (r/min)	Maximum admissible current (A)			Power installed (kW)	Tilting angle blades (°)	Airflow maximum (m³/h)	Sound pressure level dB(A)	Approx. weight (Kg)
		230V	400V	690V					
CJTHT-40-2/4T-1.5/PLUS	2900 / 1450		2.90 / 1.10		1.10 / 0.25	20	7050 / 3525	71 / 56	53
CJTHT-40-2/4T-2/PLUS	2940 / 1460		4.40 / 1.40		1.50 / 0.37	24	7950 / 3975	72 / 57	54
CJTHT-40-4T-0.75/PLUS	1420	2.90	1.70		0.55	32	4800	59	47
CJTHT-40-6T-0.75/PLUS	930	3.30	1.90		0.55	32	3150	49	52
CJTHT-40-6/12T-0.75/PLUS	940 / 460		2.10 / 0.90		0.55 / 0.09	32	3150 / 1575	49 / 34	56
CJTHT-45-2/4T-2/PLUS	2940 / 1460		4.40 / 1.40		1.50 / 0.37	16	9400 / 4700	73 / 58	56
CJTHT-45-2/4T-3/PLUS	2930 / 1450		5.70 / 1.80		2.20 / 0.60	22	11350 / 5675	75 / 60	58
CJTHT-45-4T-0.75/PLUS	1420	2.90	1.70		0.55	36	7450	63	49
CJTHT-45-6T-0.75/PLUS	930	3.30	1.90		0.55	30	4450	51	53
CJTHT-45-6/12T-0.75/PLUS	940 / 460		2.10 / 0.90		0.55 / 0.09	30	4450 / 2225	51 / 36	58
CJTHT-50-2/4T-4/PLUS	2920 / 1440		6.70 / 2.00		3.00 / 0.80	16	13900 / 6950	77 / 60	65

Technical characteristics

Model	Speed (r/min)	Maximum admissible current (A)			Power installed (kW)	Tilting angle blades (°)	Airflow maximum (m³/h)	Sound pressure level dB(A)	Approx. weight (Kg)
		230V	400V	690V					
CJTHT-50-2/4T-6/PLUS	2930 / 1450		10.00 / 3.20		4.50 / 1.30	20	15900 / 7950	78 / 63	81
CJTHT-50-4T-1/PLUS	1430	3.80	2.20		0.75	28	9750	64	51
CJTHT-50-6T-0.75/PLUS	930	3.30	1.90		0.55	32	7000	53	55
CJTHT-50-6/12T-0.75/PLUS	940 / 460		2.10 / 0.90		0.55 / 0.09	32	7000 / 3500	53 / 38	59
CJTHT-56-2/4T-6/PLUS	2930 / 1450		10.00 / 3.20		4.50 / 1.30	16	18800 / 9400	83 / 67	90
CJTHT-56-2/4T-12/PLUS	2920 / 1440		18.50 / 5.50		9.00 / 2.50	30	27200 / 13600	84 / 69	153
CJTHT-56-4T-1/PLUS	1430	3.80	2.20		0.75	22	11250	68	62
CJTHT-56-4T-1.5/PLUS	1420	4.70	2.70		1.10	30	13600	69	64
CJTHT-56-4/8T-1.5/PLUS	1440 / 710		2.90 / 1.40		1.10 / 0.25	30	13600 / 6800	69 / 52	68
CJTHT-56-4T-2/PLUS	1425	6.60	3.80		1.50	36	15050	70	68
CJTHT-56-4/8T-2/PLUS	1415 / 715		3.60 / 1.50		1.50 / 0.30	36	15050 / 7525	70 / 53	80
CJTHT-56-6T-0.75/PLUS	930	3.30	1.90		0.55	38	10150	58	64
CJTHT-56-6/12T-0.75/PLUS	940 / 460		2.10 / 0.90		0.55 / 0.09	38	10150 / 5075	58 / 41	68
CJTHT-63-4T-1/PLUS	1430	3.80	2.20		0.75	14	15200	68	66
CJTHT-63-4T-1.5/PLUS	1420	4.70	2.70		1.10	20	17800	69	69
CJTHT-63-4/8T-1.5/PLUS	1440 / 710		2.90 / 1.40		1.10 / 0.25	20	17800 / 8900	69 / 52	72
CJTHT-63-4T-2/PLUS	1425	6.60	3.80		1.50	24	19300	70	72
CJTHT-63-4/8T-2/PLUS	1415 / 715		3.60 / 1.50		1.50 / 0.30	24	19300 / 9650	70 / 53	84
CJTHT-63-4T-3/PLUS	1435	9.20	5.30		2.20	32	22150	72	78
CJTHT-63-4/8T-3/PLUS	1415 / 715		5.20 / 1.90		2.20 / 0.45	32	22150 / 11075	72 / 54	90
CJTHT-63-4T-4/PLUS	1430	11.40	6.60		3.00	38	24250	73	87
CJTHT-63-4/8T-4/PLUS	1420 / 705		6.90 / 2.30		3.00 / 0.60	38	24250 / 12125	73 / 55	101
CJTHT-63-6T-0.75/PLUS	930	3.30	1.90		0.55	28	13600	61	68
CJTHT-63-6/12T-0.75/PLUS	940 / 460		2.10 / 0.90		0.55 / 0.09	28	13600 / 6800	61 / 44	72
CJTHT-63-6T-1/PLUS	940	4.40	2.60		0.75	38	15900	62	72
CJTHT-63-6/12T-1/PLUS	935 / 430		2.50 / 1.03		0.75 / 0.15	38	15900 / 7950	62 / 45	78
CJTHT-71-4T-1.5/PLUS	1420	4.70	2.70		1.10	12	19500	74	85
CJTHT-71-4/8T-1.5/PLUS	1440 / 710		2.90 / 1.40		1.10 / 0.25	12	19500 / 9750	74 / 59	89
CJTHT-71-4T-2/PLUS	1425	6.60	3.80		1.50	14	20900	75	89
CJTHT-71-4/8T-2/PLUS	1415 / 715		3.60 / 1.50		1.50 / 0.30	14	20900 / 10450	75 / 60	101
CJTHT-71-4T-3/PLUS	1435	9.20	5.30		2.20	22	25100	76	95
CJTHT-71-4/8T-3/PLUS	1415 / 715		5.20 / 1.90		2.20 / 0.45	22	25100 / 12550	76 / 62	107
CJTHT-71-4T-4/PLUS	1430	11.40	6.60		3.00	28	27500	77	104
CJTHT-71-4/8T-4/PLUS	1420 / 705		6.90 / 2.30		3.00 / 0.60	28	27500 / 13750	77 / 63	118
CJTHT-71-6T-0.75/PLUS	930	3.30	1.90		0.55	20	16100	63	85
CJTHT-71-6/12T-0.75/PLUS	940 / 460		2.10 / 0.90		0.55 / 0.09	20	16100 / 8050	63 / 49	89
CJTHT-71-6T-1/PLUS	940	4.40	2.60		0.75	26	17300	64	88
CJTHT-71-6/12T-1/PLUS	935 / 430		2.50 / 1.03		0.75 / 0.15	26	17300 / 8650	64 / 49	95
CJTHT-71-6T-1.5/PLUS	945	6.40	3.70		1.10	34	19950	65	94
CJTHT-71-6/12T-1.5/PLUS	940 / 450		3.30 / 1.20		1.10 / 0.18	34	19950 / 9975	65 / 50	102
CJTHT-80-4T-3/PLUS	1435	9.20	5.30		2.20	12	25450	78	103
CJTHT-80-4/8T-3/PLUS	1415 / 715		5.20 / 1.90		2.20 / 0.45	12	25450 / 12725	78 / 63	115
CJTHT-80-4T-4/PLUS	1430	11.40	6.60		3.00	16	30250	79	112
CJTHT-80-4/8T-4/PLUS	1420 / 705		6.90 / 2.30		3.00 / 0.60	16	30250 / 15125	79 / 64	125
CJTHT-80-4T-5.5/PLUS	1440		8.40	4.85	4.00	18	32750	80	118
CJTHT-80-4/8T-5.5/PLUS	1450 / 720		9.40 / 3.50		4.00 / 0.80	18	32750 / 16375	80 / 65	153
CJTHT-80-6T-1.5/PLUS	945	6.40	3.70		1.10	18	21450	68	102
CJTHT-80-6/12T-1.5/PLUS	940 / 450		3.30 / 1.20		1.10 / 0.18	18	21450 / 10725	68 / 53	110
CJTHT-80-6T-2/PLUS	945	7.40	4.30		1.50	26	25950	69	111
CJTHT-80-6/12T-2/PLUS	960 / 470		4.30 / 1.70		1.50 / 0.25	26	25950 / 12975	69 / 54	115
CJTHT-80-6T-3/PLUS	950	10.30	5.90		2.20	32	29950	70	118
CJTHT-80-6/12T-3/PLUS	940 / 470		5.60 / 2.20		2.20 / 0.37	32	29950 / 14975	70 / 55	124
CJTHT-80-8T-0.75/PLUS	700	3.60	2.10		0.55	20	17550	67	95

Technical characteristics

Model	Speed (r/min)	Maximum admissible current (A)			Power installed (kW)	Tilting angle blades (°)	Airflow maximum (m³/h)	Sound pressure level dB(A)	Approx. weight (Kg)
		230V	400V	690V					
CJTHT-80-8T-1/PLUS	710	4.80	2.80		0.75	28	20650	68	102
CJTHT-90-4T-4/PLUS	1430	11.40	6.60		3.00	8	33600	82	136
CJTHT-90-4/8T-4/PLUS	1420 / 705		6.90 / 2.30		3.00 / 0.60	8	33600 / 16800	82 / 68	149
CJTHT-90-4T-5.5/PLUS	1440		8.40	4.85	4.00	12	38900	84	142
CJTHT-90-4/8T-5.5/PLUS	1450 / 720		9.40 / 3.50		4.00 / 0.80	12	38900 / 19450	84 / 69	177
CJTHT-90-4T-7.5/PLUS	1430		11.50	6.64	5.50	18	46150	86	168
CJTHT-90-4/8T-7.5/PLUS	1455 / 725		12.80 / 4.60		5.50 / 1.10	18	46150 / 23075	86 / 72	182
CJTHT-90-4T-10/PLUS	1460		17.70	10.22	7.50	22	50150	87	179
CJTHT-90-4/8T-9/PLUS	1455 / 725		15.50 / 5.50		6.70 / 1.50	22	50150 / 25075	87 / 73	182
CJTHT-90-6T-2/PLUS	945	7.40	4.30		1.50	16	28800	74	135
CJTHT-90-6/12T-2/PLUS	960 / 470		4.30 / 1.70		1.50 / 0.25	16	28800 / 14400	74 / 59	139
CJTHT-90-6T-3/PLUS	950	10.30	5.90		2.20	24	34000	75	142
CJTHT-90-6/12T-3/PLUS	940 / 470		5.60 / 2.20		2.20 / 0.37	24	34000 / 17000	75 / 60	148
CJTHT-90-6T-4/PLUS	945	15.00	8.70		3.00	30	38900	76	166
CJTHT-90-6/12T-4/PLUS	970 / 475		8.90 / 3.50		3.00 / 0.55	30	38900 / 19450	76 / 61	168
CJTHT-90-8T-1/PLUS	710	4.80	2.80		0.75	18	22900	68	126
CJTHT-90-8T-2/PLUS	700	9.00	5.20		1.50	30	29500	69	142
CJTHT-90-8T-3/PLUS	705	13.20	7.60		2.20	32	30850	70	158
CJTHT-100-4T-7.5/PLUS	1430		11.50	6.64	5.50	10	46850	88	176
CJTHT-100-4/8T-7.5/PLUS	1455 / 725		12.80 / 4.60		5.50 / 1.10	10	46850 / 23425	88 / 73	190
CJTHT-100-4T-10/PLUS	1460		17.70	10.22	7.50	16	57400	89	187
CJTHT-100-4/8T-9/PLUS	1455 / 725		15.50 / 5.50		6.70 / 1.50	14	54700 / 27350	89 / 74	190
CJTHT-100-4T-15/PLUS	1455		23.00	13.28	11.00	22	66300	90	231
CJTHT-100-4/8T-15/PLUS	1470 / 725		23.20 / 8.70		11.00 / 2.80	22	66300 / 33150	90 / 75	231
CJTHT-100-4T-20/PLUS	1460		29.00	16.74	15.00	28	76150	91	246
CJTHT-100-4/8T-20/PLUS	1470 / 725		31.70 / 11.80		15.00 / 3.80	28	76150 / 38075	91 / 76	246
CJTHT-100-6T-3/PLUS	950	10.30	5.90		2.20	16	37600	79	150
CJTHT-100-6/12T-3/PLUS	940 / 470		5.60 / 2.20		2.20 / 0.37	16	37600 / 18800	79 / 64	156
CJTHT-100-6T-4/PLUS	945	15.00	8.70		3.00	20	41150	80	175
CJTHT-100-6/12T-4/PLUS	970 / 475		8.90 / 3.50		3.00 / 0.55	20	41150 / 20575	80 / 65	176
CJTHT-100-6T-5.5/PLUS	970		11.00	6.35	4.00	26	47800	81	187
CJTHT-100-6/12T-5.5/PLUS	970 / 480		11.30 / 4.20		4.00 / 0.65	26	47800 / 23900	81 / 66	187
CJTHT-100-8T-2/PLUS	700	9.00	5.20		1.50	22	32900	74	150
CJTHT-100-8T-3/PLUS	705	13.20	7.60		2.20	30	39400	74	167
CJTHT-100-8T-4/PLUS	710	15.60	9.00		3.00	32	40550	75	187

Acoustic features

The specified values are determined according to free field measurements of pressure and sound levels in dB(A) at an equivalent distance of twice the fan's span plus the impeller's diameter, with a minimum of 1.5 m.

Sound power Lw(A) spectrum in dB(A) via frequency band in Hz.

Model	63	125	250	500	1000	2000	4000	8000	Model	63	125	250	500	1000	2000	4000	8000
40-2-1.5	43	64	71	76	79	75	68	57	50-6	28	48	56	61	63	60	53	42
40-2-2	44	65	72	77	80	76	69	58	50-12	13	33	41	46	48	45	38	27
40-4-0.75	31	52	59	64	67	63	56	45	56-2-6	58	78	86	91	93	90	83	72
40-4-1.5	28	49	56	61	64	60	53	42	56-2-12	59	79	87	92	94	91	84	73
40-4-2	29	50	57	62	65	61	54	43	56-4-1	43	63	71	76	78	75	68	57
40-6	21	42	49	54	57	53	46	35	56-4-1.5	44	64	72	77	79	76	69	58
40-12	6	27	34	39	42	38	31	20	56-4-2	45	65	73	78	80	77	70	59
45-2-2	45	66	73	78	81	77	70	59	56-4-6	42	62	70	75	77	74	67	56
45-2-3	47	68	75	80	83	79	72	61	56-4-12	44	64	72	77	79	76	69	58
45-4-0.75	35	56	63	68	71	67	60	49	56-6	33	53	61	66	68	65	58	47
45-4-2	30	51	58	63	66	62	55	44	56-8-1.5	27	47	55	60	62	59	52	41
45-4-3	32	53	60	65	68	64	57	46	56-8-2	28	48	56	61	63	60	53	42
45-6	23	44	51	56	59	55	48	37	56-12	16	36	44	49	51	48	41	30
45-12	8	29	36	41	44	40	33	22	63-4-1	45	65	73	78	80	77	70	59
50-2-4	52	72	80	85	87	84	77	66	63-4-1.5	44	64	72	77	79	76	69	60
50-2-6	53	73	81	86	88	85	78	67	63-4-2	47	64	72	77	79	76	69	61
50-4-1	39	59	67	72	74	71	64	53	63-4-3	49	67	75	80	82	79	74	63
50-4-4	35	55	63	68	70	67	60	49	63-4-4	50	68	76	81	83	80	75	64
50-4-6	38	58	66	71	73	70	63	52	63-6-0.75	38	56	64	69	71	68	61	52

Acoustic features

Sound power Lw(A) spectrum in dB(A) via frequency band in Hz.

63-6-1	39	58	66	71	73	70	63	53	90-4-5.5	56	77	84	89	92	88	81	70
63-8-1.5	27	47	55	60	62	59	52	43	90-4-7.5	55	76	83	88	91	87	80	69
63-8-2	30	47	55	60	62	59	52	44	90-4-9	54	75	82	87	90	86	79	68
63-8-3	31	49	57	62	64	61	56	45	90-4-10	54	75	82	87	90	86	79	68
63-8-4	32	50	58	63	65	62	57	46	90-6-2	46	67	74	79	82	78	71	60
63-12-0.75	21	37	45	50	52	49	42	31	90-6-3	53	67	74	79	82	78	71	60
63-12-1	22	39	47	52	54	51	44	36	90-6-4	54	69	76	81	84	80	73	62
71-4-1.5	51	71	79	84	86	83	76	65	90-8-1	39	60	67	72	75	71	64	53
71-4-2	50	70	78	83	85	82	75	66	90-8-2	47	62	69	74	77	73	66	55
71-4-3	53	68	76	81	83	80	73	67	90-8-3	48	62	69	74	77	73	66	55
71-4-4	54	69	77	82	84	81	74	68	90-8-4	43	64	71	76	79	75	68	60
71-6-0.75	40	60	68	71	73	70	63	52	90-8-5.5	41	62	69	74	77	73	66	55
71-6-1	41	61	69	71	73	70	63	52	90-8-7.5	40	61	68	73	76	72	65	54
71-6-1.5	42	62	67	72	74	71	64	53	90-8-9	40	61	68	73	76	72	65	54
71-8-1.5	36	55	63	68	70	67	61	50	90-12-2	29	50	57	62	65	61	54	43
71-8-2	35	55	63	68	70	67	60	51	90-12-3	38	50	57	62	65	61	54	43
71-8-3	39	54	62	67	69	66	59	53	90-12-4	39	52	59	64	67	63	56	45
71-8-4	40	55	63	68	70	67	60	54	100-4-7.5	61	81	89	94	96	93	86	75
71-12-0.75	26	42	50	55	57	54	47	36	100-4-9	60	80	88	93	95	92	85	74
71-12-1	26	42	50	55	57	54	47	36	100-4-10	59	79	87	92	94	91	84	73
71-12-1.5	27	42	50	55	57	54	47	36	100-4-15	58	78	86	91	93	90	83	72
80-4-3	55	74	82	88	89	86	80	69	100-4-20	60	80	88	93	95	92	85	74
80-4-4	53	73	81	86	88	85	78	70	100-6-3	59	70	78	83	85	82	75	64
80-4-5.5	53	73	81	86	88	85	78	71	100-6-4	60	68	76	81	83	80	73	62
80-6-1.5	45	62	70	75	77	74	67	56	100-6-5.5	61	70	78	83	85	82	75	64
80-6-2	46	63	71	76	78	75	68	57	100-8-2	54	64	72	77	79	76	69	58
80-6-3	47	64	72	77	79	76	69	58	100-8-3	54	66	74	79	81	78	71	60
80-8-0.75	44	57	65	70	72	69	62	51	100-8-4	55	66	74	79	81	78	71	60
80-8-1	45	58	66	71	73	70	63	52	100-8-7.5	46	66	74	79	81	78	71	60
80-8-3	40	59	67	73	74	71	65	54	100-8-9	45	65	73	78	80	77	70	59
80-8-4	38	58	66	71	73	70	63	55	100-8-15	43	63	71	76	78	75	68	57
80-8-5.5	37	57	65	70	72	69	62	56	100-8-20	44	64	72	77	79	76	69	58
80-12-1.5	30	45	53	58	60	57	50	39	100-12-3	44	53	61	66	68	65	58	47
80-12-2	31	46	54	59	61	58	51	40	100-12-4	45	52	60	65	67	64	57	46
80-12-3	32	47	55	60	62	59	52	41	100-12-5.5	46	53	61	66	68	65	58	47
90-4-4	57	78	85	90	93	89	82	74									

Dimensions in mm

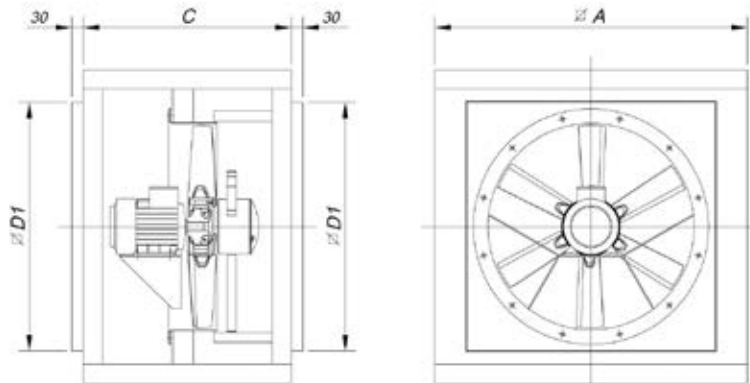

Model	∅A	C	∅D1
CJTHT/PLUS-40/45/50	700	550	565
CJTHT/PLUS-56/63	825	550	690
CJTHT/PLUS-71/80	1000	650	850
CJTHT/PLUS-90/100	1200	750	1050

Characteristic curves

See characteristic curves on page 33.

Accessories

See accessories section



CJTHT

CJTHT: 400°C/2h, 300°C/2h and 200°C/2h axial extraction units with soundproofed box
CJTHT/ATEX: 400°C/2h, 300°C/2h and 200°C/2h axial extraction units with ATEX certification



Extraction units to work inside fire danger zones at 400°C/2h, with soundproofed box.

Fan:

- Galvanised sheet steel structure with thermal insulation and soundproofing.
- Turnable impellers cast aluminium.
- Units suitable for working in both horizontal and vertical positions.
- Approval according to Standard EN-12101-3-2002, certificate no.: 0370-CPD-0312
- CJTHT/ATEX: with ATEX certification, category 3 Ex II3G. In accordance with Spanish Low Voltage Regulation ITC 29 ATEX for Zone 2 rated car parks.



Motor:

- Class H motors, ongoing use S1 and emergency use S2, with ball bearings, IP55 protection, and one- or two- speed depending on the model.
- Three-phase 230/400V.-50Hz. (up to 4CV.) and 400/690V.-50Hz. (power over 4CV.)
- Max. temperature of air for transport: S1 Service -20°C+ 40°C for ongoing use, S2 Service 200°C/2h, 300°C/2h, 400°C/2h

Finish:

- Anticorrosive galvanized sheet steel.

On request:

- 100% reversible impellers.



Detail CJTHT/ATEX

Order code

From size 40 to size 100

CJTHT — 56 — 4T — 2 — F-400

CJTHT: 400°C/2h, 300°C/2h and 200°C/2h axial extraction units with soundproofed box

Impeller diameter in cm.

Number of motor poles
 T=Three-phase
 2=2900 r/min. 50 Hz
 4=1400 r/min. 50 Hz
 6=900 r/min. 50 Hz
 8=750 r/min. 50 Hz
 12=500 r/min. 50 Hz

Power motor (c.v.)

F-200 Officially approved 200°C/2h
 F-300 Officially approved, tested for 300°C/2h
 F-400 Officially approved 400°C/2h
 CAT3: With ATEX certification, Category 3 Ex II3G.

CJTHT/ATEX: 400°C/2h, 300°C/2h and 200°C/2h axial extraction units with ATEX certification

Size 125

CJTHT — 125 — 4T / — 9-10 — 15 — F-400

CJTHT: 400°C/2h, 300°C/2h and 200°C/2h axial extraction units with soundproofed box

Impeller diameter in cm.

Number of motor poles
 T=Three-phase
 2=2900 r/min. 50 Hz
 4=1400 r/min. 50 Hz
 6=900 r/min. 50 Hz
 8=750 r/min. 50 Hz
 12=500 r/min. 50 Hz

T=Three-phase

Number of blades
 3 blades
 6 blades
 9 blades

Angle of inclination of the blades

Power motor (c.v.)

F-200 Officially approved 200°C/2h
 F-300 Officially approved, tested for 300°C/2h
 F-400 Officially approved 400°C/2h
 CAT3: With ATEX certification, Category 3 Ex II3G.

Technical characteristics

Model	Speed (r/min)	Maximum admissible current (A)			Power installed (kW)	Tilting angle blades (°)	Airflow maximum (m³/h)	Sound pressure level dB(A)	Approx. weight (Kg)
		230V	400V	690V					
CJTHT-40-2/4T-1,5	2900 / 1450		2.90 / 1.10		1.10 / 0.25	20	7050 / 3525	73 / 58	50
CJTHT-40-2/4T-2	2940 / 1460		4.40 / 1.40		1.50 / 0.37	24	7950 / 3975	74 / 59	51
CJTHT-40-4T-0,75	1420	2.90	1.70		0.55	32	4800	61	41
CJTHT-40-6T-0,75	930	3.30	1.90		0.55	32	3150	51	49
CJTHT-40-6/12T-0,75	940 / 460		2.10 / 0.90		0.55 / 0.09	32	3150 / 1575	51 / 36	53
CJTHT-45-2/4T-2	2940 / 1460		4.40 / 1.40		1.50 / 0.37	16	9400 / 4700	75 / 60	53
CJTHT-45-2/4T-3	2930 / 1450		5.70 / 1.80		2.20 / 0.60	22	11350 / 5675	77 / 62	55
CJTHT-45-4T-0,75	1420	2.90	1.70		0.55	36	7450	65	43
CJTHT-45-6T-0,75	930	3.30	1.90		0.55	30	4450	53	51
CJTHT-45-6/12T-0,75	940 / 460		2.10 / 0.90		0.55 / 0.09	30	4450 / 2225	53 / 38	55
CJTHT-50-2/4T-4	2920 / 1440		6.70 / 2.00		3.00 / 0.80	16	13900 / 6950	79 / 64	62
CJTHT-50-2/4T-6	2930 / 1450		10.00 / 3.20		4.50 / 1.30	20	15900 / 7950	80 / 65	78
CJTHT-50-4T-1	1430	3.80	2.20		0.75	28	9750	66	50
CJTHT-50-6T-0,75	930	3.30	1.90		0.55	32	7000	55	52
CJTHT-50-6/12T-0,75	940 / 460		2.10 / 0.90		0.55 / 0.09	32	7000 / 3500	55 / 40	56
CJTHT-56-2/4T-6	2930 / 1450		10.00 / 3.20		4.50 / 1.30	16	18800 / 9400	85 / 69	87
CJTHT-56-2/4T-12	2920 / 1440		18.50 / 5.50		9.00 / 2.50	30	27200 / 13600	86 / 71	153
CJTHT-56-4T-1	1430	3.80	2.20		0.75	22	11250	70	59
CJTHT-56-4T-1,5	1420	4.70	2.70		1.10	30	13600	71	61
CJTHT-56-4/8T-1,5	1440 / 710		2.90 / 1.40		1.10 / 0.25	30	13600 / 6800	71 / 56	65
CJTHT-56-4T-2	1425	6.60	3.80		1.50	36	15050	72	63
CJTHT-56-4/8T-2	1415 / 715		3.60 / 1.50		1.50 / 0.30	36	15050 / 7525	72 / 57	69
CJTHT-56-6T-0,75	930	3.30	1.90		0.55	38	10150	60	61
CJTHT-56-6/12T-0,75	940 / 460		2.10 / 0.90		0.55 / 0.09	38	10150 / 5075	60 / 45	65
CJTHT-63-4T-1	1430	3.80	2.20		0.75	14	15200	70	63
CJTHT-63-4T-1,5	1420	4.70	2.70		1.10	20	17800	71	66
CJTHT-63-4/8T-1,5	1440 / 710		2.90 / 1.40		1.10 / 0.25	20	17800 / 8900	71 / 56	69
CJTHT-63-4T-2	1425	6.60	3.80		1.50	24	19300	72	67
CJTHT-63-4/8T-2	1415 / 715		3.60 / 1.50		1.50 / 0.30	24	19300 / 9650	72 / 57	74
CJTHT-63-4T-3	1435	9.20	5.30		2.20	32	22150	73	73
CJTHT-63-4/8T-3	1415 / 715		5.20 / 1.90		2.20 / 0.45	32	22150 / 11075	73 / 58	87
CJTHT-63-4T-4	1430	11.40	6.60		3.00	38	24250	74	78
CJTHT-63-4/8T-4	1420 / 705		6.90 / 2.30		3.00 / 0.60	38	24250 / 12125	74 / 59	91
CJTHT-63-6T-0,75	930	3.30	1.90		0.55	28	13600	63	66
CJTHT-63-6/12T-0,75	940 / 460		2.10 / 0.90		0.55 / 0.09	28	13600 / 6800	63 / 48	69
CJTHT-63-6T-1	940	4.40	2.60		0.75	38	15900	64	67
CJTHT-63-6/12T-1	935 / 430		2.50 / 1.03		0.75 / 0.15	38	15900 / 7950	64 / 49	71
CJTHT-71-4T-1,5	1420	4.70	2.70		1.10	12	19500	75	82
CJTHT-71-4/8T-1,5	1440 / 710		2.90 / 1.40		1.10 / 0.25	12	19500 / 9750	75 / 60	86
CJTHT-71-4T-2	1425	6.60	3.80		1.50	14	20900	76	84
CJTHT-71-4/8T-2	1415 / 715		3.60 / 1.50		1.50 / 0.30	14	20900 / 10450	76 / 61	91
CJTHT-71-4T-3	1435	9.20	5.30		2.20	22	25100	78	90
CJTHT-71-4/8T-3	1415 / 715		5.20 / 1.90		2.20 / 0.45	22	25100 / 12550	78 / 63	103
CJTHT-71-4T-4	1430	11.40	6.60		3.00	28	27500	79	95
CJTHT-71-4/8T-4	1420 / 705		6.90 / 2.30		3.00 / 0.60	28	27500 / 13750	79 / 64	108
CJTHT-71-6T-0,75	930	3.30	1.90		0.55	20	16100	65	82
CJTHT-71-6/12T-0,75	940 / 460		2.10 / 0.90		0.55 / 0.09	20	16100 / 8050	65 / 50	86
CJTHT-71-6T-1	940	4.40	2.60		0.75	26	17300	66	84
CJTHT-71-6/12T-1	935 / 430		2.50 / 1.03		0.75 / 0.15	26	17300 / 8650	66 / 51	87
CJTHT-71-6T-1,5	945	6.40	3.70		1.10	34	19950	67	86
CJTHT-71-6/12T-1,5	940 / 450		3.30 / 1.20		1.10 / 0.18	34	19950 / 9975	67 / 52	97
CJTHT-80-4T-3	1435	9.20	5.30		2.20	12	25450	79	98
CJTHT-80-4/8T-3	1415 / 715		5.20 / 1.90		2.20 / 0.45	12	25450 / 12725	79 / 64	111

Technical characteristics

Model	Speed (r/min)	Maximum admissible current (A)			Power installed (kW)	Tilting angle blades (°)	Airflow maximum (m³/h)	Sound pressure level dB(A)	Approx. weight (Kg)
		230V	400V	690V					
CJTHT-80-4T-4	1430	11.40	6.60		3.00	16	30250	80	103
CJTHT-80-4/8T-4	1420 / 705		6.90 / 2.30		3.00 / 0.60	16	30250 / 15125	80 / 65	115
CJTHT-80-4T-5,5	1440		8.40	4.85	4.00	18	32750	81	113
CJTHT-80-4/8T-5,5	1450 / 720		9.40 / 3.50		4.00 / 0.80	18	32750 / 16375	81 / 66	147
CJTHT-80-6T-1,5	945	6.40	3.70		1.10	18	21450	70	95
CJTHT-80-6/12T-1,5	940 / 450		3.30 / 1.20		1.10 / 0.18	18	21450 / 10725	70 / 55	105
CJTHT-80-6T-2	945	7.40	4.30		1.50	26	25950	71	99
CJTHT-80-6/12T-2	960 / 470		4.30 / 1.70		1.50 / 0.25	26	25950 / 12975	71 / 56	113
CJTHT-80-6T-3	950	10.30	5.90		2.20	32	29950	72	113
CJTHT-80-6/12T-3	940 / 470		5.60 / 2.20		2.20 / 0.37	32	29950 / 14975	72 / 57	118
CJTHT-80-8T-0,75	700	3.60	2.10		0.55	20	17550	68	99
CJTHT-80-8T-1	710	4.80	2.80		0.75	28	20650	69	111
CJTHT-90-4T-4	1430	11.40	6.60		3.00	8	33600	84	127
CJTHT-90-4/8T-4	1420 / 705		6.90 / 2.30		3.00 / 0.60	8	33600 / 16800	84 / 69	139
CJTHT-90-4T-5,5	1440		8.40	4.85	4.00	12	38900	86	137
CJTHT-90-4/8T-5,5	1450 / 720		9.40 / 3.50		4.00 / 0.80	12	38900 / 19450	86 / 71	171
CJTHT-90-4T-7,5	1430		11.50	6.64	5.50	18	46150	88	171
CJTHT-90-4/8T-7,5	1455 / 725		12.80 / 4.60		5.50 / 1.10	18	46150 / 23075	88 / 73	190
CJTHT-90-4T-10	1460		17.70	10.22	7.50	22	50150	89	208
CJTHT-90-4/8T-9	1455 / 725		15.50 / 5.50		6.70 / 1.50	22	50150 / 25075	89 / 74	198
CJTHT-90-6T-2	945	7.40	4.30		1.50	16	28800	75	123
CJTHT-90-6/12T-2	960 / 470		4.30 / 1.70		1.50 / 0.25	16	28800 / 14400	75 / 60	137
CJTHT-90-6T-3	950	10.30	5.90		2.20	24	34000	76	137
CJTHT-90-6/12T-3	940 / 470		5.60 / 2.20		2.20 / 0.37	24	34000 / 17000	76 / 61	142
CJTHT-90-6T-4	945	15.00	8.70		3.00	30	38900	77	171
CJTHT-90-6/12T-4	970 / 475		8.90 / 3.50		3.00 / 0.55	30	38900 / 19450	77 / 62	171
CJTHT-90-8T-1	710	4.80	2.80		0.75	18	22900	69	135
CJTHT-90-8T-2	700	9.00	5.20		1.50	30	29500	71	139
CJTHT-90-8T-3	705	13.20	7.60		2.20	32	30850	72	171
CJTHT-100-4T-7,5	1430		11.50	6.64	5.50	10	46850	89	179
CJTHT-100-4/8T-7,5	1455 / 725		12.80 / 4.60		5.50 / 1.10	10	46850 / 23425	89 / 74	198
CJTHT-100-4T-10	1460		17.70	10.22	7.50	16	57400	90	216
CJTHT-100-4/8T-9	1455 / 725		15.50 / 5.50		6.70 / 1.50	14	54700 / 27350	90 / 75	206
CJTHT-100-4T-15	1455		23.00	13.28	11.00	22	66300	91	251
CJTHT-100-4/8T-15	1470 / 725		23.20 / 8.70		11.00 / 2.80	22	66300 / 33150	91 / 76	251
CJTHT-100-4T-20	1460		29.00	16.74	15.00	28	76150	92	258
CJTHT-100-4/8T-20	1470 / 725		31.70 / 11.80		15.00 / 3.80	28	76150 / 38075	92 / 77	258
CJTHT-100-6T-3	950	10.30	5.90		2.20	16	37600	80	145
CJTHT-100-6/12T-3	940 / 470		5.60 / 2.20		2.20 / 0.37	16	37600 / 18800	80 / 65	150
CJTHT-100-6T-4	945	15.00	8.70		3.00	20	41150	81	179
CJTHT-100-6/12T-4	970 / 475		8.90 / 3.50		3.00 / 0.55	20	41150 / 20575	81 / 66	179
CJTHT-100-6T-5,5	970		11.00	6.35	4.00	26	47800	82	187
CJTHT-100-6/12T-5,5	970 / 480		11.30 / 4.20		4.00 / 0.65	26	47800 / 23900	82 / 67	206
CJTHT-100-8T-2	700	9.00	5.20		1.50	22	32900	75	147
CJTHT-100-8T-3	705	13.20	7.60		2.20	30	39400	75	179
CJTHT-100-8T-4	710	15.60	9.00		3.00	32	40550	76	216
CJTHT-125-4T/3-10	1460		17.70	10.22	7.50	8	58550	85	395
CJTHT-125-4/8T/3-9	1455 / 725		15.50 / 5.50		6.70 / 1.50	8	58550 / 29275	85 / 65	409
CJTHT-125-4T/3-15	1455		23.00	13.28	11.00	14	77750	86	450
CJTHT-125-4/8T/3-15	1470 / 725		23.20 / 8.70		11.00 / 2.80	14	77750 / 38875	86 / 66	456
CJTHT-125-4T/3-20	1460		29.00	16.74	15.00	18	91450	88	457
CJTHT-125-4/8T/3-20	1470 / 725		31.70 / 11.80		15.00 / 3.80	18	91450 / 45725	88 / 68	476
CJTHT-125-4T/3-25	1465		37.00	21.36	18.50	20	98350	88	540

Technical characteristics

Model	Speed (r/min)	Maximum admissible current (A)			Power installed (kW)	Tilting angle blades (°)	Airflow maximum (m³/h)	Sound pressure level dB(A)	Approx. weight (Kg)
		230V	400V	690V					
CJTHT-125-4T/3-30	1470		42.00	24.25	22.00	24	110350	89	545
CJTHT-125-4/8T/3-27	1470 / 735		38.00 / 13.00		20.00 / 4.00	22	104400 / 52200	89 / 68	548
CJTHT-125-4/8T/3-37	1475 / 735		51.00 / 20.60		27.00 / 6.00	28	120700 / 60350	90 / 69	625
CJTHT-125-4T/3-40	1475		58.00	33.49	30.00	30	125000	90	598
CJTHT-125-4/8T/3-40	1480 / 735		62.00 / 27.00		30.00 / 10.00	30	125000 / 62500	90 / 69	638
CJTHT-125-4T/6-20	1460		29.00	16.74	15.00	10	78600	86	466
CJTHT-125-4/8T/6-20	1470 / 725		31.70 / 11.80		15.00 / 3.80	10	78600 / 39300	86 / 65	485
CJTHT-125-4/8T/6-22	1470 / 735		31.80 / 12.00		16.50 / 3.30	12	85600 / 42800	86 / 66	555
CJTHT-125-4T/6-25	1465		37.00	21.36	18.50	14	92550	87	549
CJTHT-125-4/8T/6-27	1470 / 735		38.00 / 13.00		20.00 / 4.00	16	98850 / 49425	87 / 66	557
CJTHT-125-4T/6-30	1470		42.00	24.25	22.00	16	98850	87	554
CJTHT-125-4/8T/6-37	1475 / 735		51.00 / 20.60		27.00 / 6.00	20	110900 / 55450	87 / 67	633
CJTHT-125-4T/6-40	1475		58.00	33.49	30.00	22	117450	89	606
CJTHT-125-4/8T/6-40	1480 / 735		62.00 / 27.00		30.00 / 10.00	22	117450 / 58725	89 / 68	646
CJTHT-125-4T/6-50	1480		73.00	42.15	37.00	26	131050	90	734
CJTHT-125-4T/9-25	1465		37.00	21.36	18.50	10	79650	85	558
CJTHT-125-4/8T/9-22	1470 / 735		31.80 / 12.00		16.50 / 3.30	8	71150 / 35575	85 / 66	564
CJTHT-125-4T/9-30	1470		42.00	24.25	22.00	12	88300	86	563
CJTHT-125-4/8T/9-27	1470 / 735		38.00 / 13.00		20.00 / 4.00	12	88300 / 44150	86 / 67	566
CJTHT-125-4/8T/9-37	1475 / 735		51.00 / 20.60		27.00 / 6.00	16	104050 / 52025	87 / 67	642
CJTHT-125-4T/9-40	1475		58.00	33.49	30.00	16	104050	88	615
CJTHT-125-4/8T/9-40	1480 / 735		62.00 / 27.00		30.00 / 10.00	16	104050 / 52025	88 / 68	655
CJTHT-125-4T/9-50	1480		73.00	42.15	37.00	20	118400	90	743
CJTHT-125-6T/3-4	945	15.00	8.70		3.00	12	46750	77	385
CJTHT-125-6/12T/3-4	970 / 475		8.90 / 3.50		3.00 / 0.55	12	46750 / 23375	77 / 62	401
CJTHT-125-6T/3-5,5	970		11.00	6.35	4.00	16	55400	78	393
CJTHT-125-6/12T/3-5,5	970 / 480		11.30 / 4.20		4.00 / 0.65	16	55400 / 27700	78 / 63	432
CJTHT-125-6T/3-7,5	970		14.00	8.08	5.50	22	68400	79	401
CJTHT-125-6/12T/3-7,5	970 / 480		13.70 / 5.60		5.50 / 1.00	22	68400 / 34200	79 / 64	445
CJTHT-125-6T/3-10	960		18.60	10.74	7.50	28	79150	81	449
CJTHT-125-6/12T/3-10	970 / 480		19.00 / 8.00		7.50 / 1.40	28	79150 / 39575	81 / 66	457
CJTHT-125-6T/3-15	955		26.00	15.01	11.00	34	87150	82	466
CJTHT-125-6/12T/3-15	970 / 470		28.50 / 13.00		11.00 / 2.00	34	87150 / 43575	82 / 67	557
CJTHT-125-6T/3-20	950		35.50	20.50	15.00	38	91650	83	533
CJTHT-125-6/12T/3-24	970 / 480		36.00 / 14.50		17.50 / 3.50	38	91650 / 45825	83 / 68	623
CJTHT-125-6T/6-5,5	970		11.00	6.35	4.00	10	51500	75	402
CJTHT-125-6/12T/6-5,5	970 / 480		11.30 / 4.20		4.00 / 0.65	10	51500 / 25750	75 / 60	441
CJTHT-125-6T/6-7,5	970		14.00	8.08	5.50	14	60650	75	410
CJTHT-125-6/12T/6-7,5	970 / 480		13.70 / 5.60		5.50 / 1.00	14	60650 / 30325	75 / 60	454
CJTHT-125-6T/6-10	960		18.60	10.74	7.50	20	72650	77	458
CJTHT-125-6/12T/6-10	970 / 480		19.00 / 8.00		7.50 / 1.40	20	72650 / 36325	77 / 62	466
CJTHT-125-6T/6-15	955		26.00	15.01	11.00	26	85850	79	475
CJTHT-125-6/12T/6-15	970 / 470		19.00 / 8.00		11.00 / 2.00	26	85850 / 42925	79 / 64	566
CJTHT-125-6T/6-20	950		35.50	20.50	15.00	30	92850	80	542
CJTHT-125-6/12T/6-24	970 / 480		36.00 / 14.50		17.50 / 3.50	34	99650 / 49825	80 / 65	631
CJTHT-125-6T/9-10	960		18.60	10.74	7.50	14	63500	76	467
CJTHT-125-6/12T/9-10	970 / 480		19.00 / 8.00		7.50 / 1.40	14	63500 / 31750	76 / 61	475
CJTHT-125-6T/9-15	955		26.00	15.01	11.00	20	77550	79	484
CJTHT-125-6/12T/9-15	970 / 470		28.50 / 13.00		11.00 / 2.00	20	77550 / 38775	79 / 64	575
CJTHT-125-6T/9-20	950		35.50	20.50	15.00	26	92950	82	551
CJTHT-125-6/12T/9-24	970 / 480		36.00 / 14.50		17.50 / 3.50	30	98500 / 49250	82 / 67	640

Acoustic features

The specified values are determined according to free field measurements of pressure and sound levels in dB(A) at an equivalent distance of twice the fan's span plus the impeller's diameter, with a minimum of 1.5 m.

Sound power Lw(A) spectrum in dB(A) via frequency band in Hz.

	63	125	250	500	1000	2000	4000	8000		63	125	250	500	1000	2000	4000	8000
40-2-1.5	45	66	73	78	81	77	70	59	90-12-4	40	53	60	65	68	64	57	46
40-2-2	46	67	74	79	82	78	71	60	100-4-7.5	62	82	90	95	97	94	87	76
40-4-0.75	33	54	61	66	69	65	58	47	100-4-9	61	81	89	94	96	93	86	75
40-4-1.5	30	51	58	63	66	62	55	44	100-4-10	60	80	88	93	95	92	85	74
40-4-2	31	52	59	64	67	63	56	45	100-4-15	59	79	87	92	94	91	84	73
40-6	23	44	51	56	59	55	48	37	100-4-20	61	81	89	94	96	93	86	75
40-12	8	29	36	41	44	40	33	22	100-6-3	60	71	79	84	86	83	76	65
45-2-2	47	68	75	80	83	79	72	61	100-6-4	61	69	77	82	84	81	74	63
45-2-3	49	70	77	82	85	81	74	63	100-6-5.5	62	71	79	84	86	83	76	65
45-4-0.75	37	58	65	70	73	69	62	51	100-8-2	55	65	73	78	80	77	70	59
45-4-2	32	53	60	65	68	64	57	46	100-8-3	55	67	75	80	82	79	72	61
45-4-3	34	55	62	67	70	66	59	48	100-8-4	56	67	75	80	82	79	72	61
45-6	25	46	53	58	61	57	50	39	100-8-7.5	47	67	75	80	82	79	72	61
45-12	10	31	38	43	46	42	35	24	100-8-9	46	66	74	79	81	78	71	60
50-2-4	54	74	82	87	89	86	79	68	100-8-15	44	64	72	77	79	76	69	58
50-2-6	55	75	83	88	90	87	80	69	100-8-20	45	65	73	78	80	77	70	59
50-4-1	41	61	69	74	76	73	66	55	100-12-3	45	54	62	67	69	66	59	48
50-4-4	39	59	67	72	74	71	64	53	100-12-4	46	53	61	66	68	65	58	47
50-4-6	40	60	68	73	75	72	65	54	100-12-5.5	47	54	62	67	69	66	59	48
50-6	30	50	58	63	65	62	55	44	125-4/3-9	67	73	85	95	95	91	83	79
50-12	15	35	43	48	50	47	40	29	125-4/3-10	67	73	85	95	95	91	83	79
56-2-6	60	80	88	93	95	92	85	74	125-4/3-15	68	74	86	96	96	92	84	80
56-2-12	61	81	89	94	96	93	86	75	125-4/3-20	70	76	88	98	98	94	86	82
56-4-1	45	65	73	78	80	77	70	59	125-4/3-25	70	76	88	98	98	94	86	82
56-4-1.5	46	66	74	79	81	78	71	60	125-4/3-27	71	77	89	99	99	95	87	83
56-4-2	47	67	75	80	82	79	72	61	125-4/3-30	71	77	89	99	99	95	87	83
56-4-6	44	64	72	77	79	76	69	58	125-4/3-37	72	78	90	100	100	96	88	84
56-4-12	46	66	74	79	81	78	71	60	125-4/3-40	72	78	90	100	100	96	88	84
56-6	35	55	63	68	70	67	60	49	125-6/3-4	63	71	83	87	85	80	71	67
56-8-1.5	31	51	59	64	66	63	56	45	125-6/3-5.5	64	72	84	88	86	81	72	68
56-8-2	32	52	60	65	67	64	57	46	125-6/3-7.5	65	73	85	89	87	82	73	69
56-12	20	40	48	53	55	52	45	34	125-6/3-10	67	75	87	91	89	84	75	71
63-4-1	47	67	75	80	82	79	72	61	125-6/3-15	68	76	88	92	90	85	76	72
63-4-1.5	46	66	74	79	81	78	71	62	125-6/3-20	69	77	89	93	91	86	77	73
63-4-2	49	66	74	79	81	78	71	63	125-6/3-24	69	77	89	93	91	86	77	73
63-4-3	50	68	76	81	83	80	75	64	125-6/3-9	47	53	65	75	75	71	63	59
63-4-4	51	69	77	82	84	81	76	65	125-8/3-15	48	54	66	76	76	72	64	60
63-6-0.75	40	58	66	71	73	70	63	54	125-8/3-20	50	56	68	78	78	74	66	62
63-6-1	41	60	68	73	75	72	65	55	125-8/3-27	50	56	68	78	78	74	66	62
63-8-1.5	31	51	59	64	66	63	56	47	125-8/3-37	51	57	69	79	79	75	67	63
63-8-2	34	51	59	64	66	63	56	48	125-8/3-40	51	57	69	79	79	75	67	63
63-8-3	35	53	61	66	68	65	60	49	125-12/3-4	48	56	68	72	70	65	56	52
63-8-4	36	54	62	67	69	66	61	50	125-12/3-5.5	49	57	69	73	71	66	57	53
63-12-0.75	25	41	49	54	56	53	46	35	125-12/3-7.5	50	58	70	74	72	67	58	54
63-12-1	26	43	51	56	58	55	48	40	125-12/3-10	52	60	72	76	74	69	60	56
71-4-1.5	52	72	80	85	87	84	77	66	125-12/3-15	53	61	73	77	75	70	61	57
71-4-2	51	71	79	84	86	83	76	67	125-12/3-24	54	62	74	78	76	71	62	58
71-4-3	55	70	78	83	85	82	75	69	125-4/6-20	64	72	88	95	97	92	86	82
71-4-4	56	71	79	84	86	83	76	70	125-4/6-22	64	72	88	95	97	92	86	82
71-6-0.75	42	62	70	73	75	72	65	54	125-4/6-25	65	73	89	96	98	93	87	83
71-6-1	43	63	71	73	75	72	65	54	125-4/6-27	65	73	89	96	98	93	87	83
71-6-1.5	44	64	69	74	76	73	66	55	125-4/6-30	65	73	89	96	98	93	87	83
71-8-1.5	37	56	64	69	71	68	62	51	125-4/6-37	65	73	89	96	98	93	87	83
71-8-2	36	56	64	69	71	68	61	52	125-4/6-40	67	75	91	98	100	95	89	85
71-8-3	40	55	63	68	70	67	60	54	125-4/6-50	68	76	92	99	101	96	90	86
71-8-4	41	56	64	69	71	68	61	55	125-6/6-5.5	58	67	80	83	84	81	70	66
71-12-0.75	27	43	51	56	58	55	48	37	125-6/6-7.5	58	67	80	83	84	81	70	66
71-12-1	28	44	52	57	59	56	49	38	125-6/6-10	60	69	82	85	86	83	72	68
71-12-1.5	29	44	52	57	59	56	49	38	125-6/6-15	62	71	84	87	88	85	74	70
80-4-3	56	75	83	89	90	87	81	70	125-6/6-20	63	72	85	88	89	86	75	71
80-4-4	54	74	82	87	89	86	79	71	125-6/6-24	63	72	85	88	89	86	75	71
80-4-5.5	54	74	82	87	89	86	79	72	125-8/6-20	43	51	67	74	76	71	65	61
80-6-1.5	47	64	72	77	79	76	69	58	125-8/6-22	44	52	68	75	77	72	66	62
80-6-2	48	65	73	78	80	77	70	59	125-8/6-27	44	52	68	75	77	72	66	62
80-6-3	49	66	74	79	81	78	71	60	125-8/6-37	45	53	69	76	78	73	67	63
80-8-0.75	45	58	66	71	73	70	63	52	125-8/6-40	46	54	70	77	79	74	68	64
80-8-1	46	59	67	72	74	71	64	53	125-12/6-5.5	43	52	65	68	69	66	55	51
80-8-3	41	60	68	74	75	72	66	55	125-12/6-7.5	43	52	65	68	69	66	55	51
80-8-4	39	59	67	72	74	71	64	56	125-12/6-10	45	54	67	70	71	68	57	53
80-8-5.5	38	58	66	71	73	70	63	57	125-12/6-15	47	56	69	72	73	70	59	55
80-12-1.5	32	47	55	60	62	59	52	41	125-12/6-24	48	57	70	73	74	71	60	56
80-12-2	33	48	56	61	63	60	53	42	125-4/9-22	63	71	88	94	95	90	85	81
80-12-3	34	49	57	62	64	61	54	43	125-4/9-25	63	71	88	94	95	90	85	81
90-4-4	59	80	87	92	95	91	84	76	125-4/9-27	64	72	89	95	96	91	86	82
90-4-5.5	58	79	86	91	94	90	83	72	125-4/9-30	64	72	89	95	96	91	86	82
90-4-7.5	57	78	85	90	93	89	82	71	125-4/9-37	65	73	90	96	97	92	87	83
90-4-9	56	77	84	89	92	88	81	70	125-4/9-40	66	74	91	97	98	93	88	84
90-4-10	56	77	84	89	92	88	81	70	125-4/9-50	68	76	93	99	100	95	90	86
90-6-2	47	68	75	80	83	79	72	61	125-6/9-10	56	66	81	85	84	83	72	68
90-6-3	54	68	75	80	83	79	72	61	125-6/9-15	59	69	84	88	87	86	75	71
90-6-4	55	70	77	82	85	81	74	63	125-6/9-20	62	72	87	91	90	89	78	74
90-8-1	40	61	68	73	76	72	65	54	125-6/9-24	62	72	87	91	90	89	78	74
90-8-2	49	64	71	76	79	75	68	57	125-8/9-22	44	52	69	75	76	71	66	62

Dimensions in mm

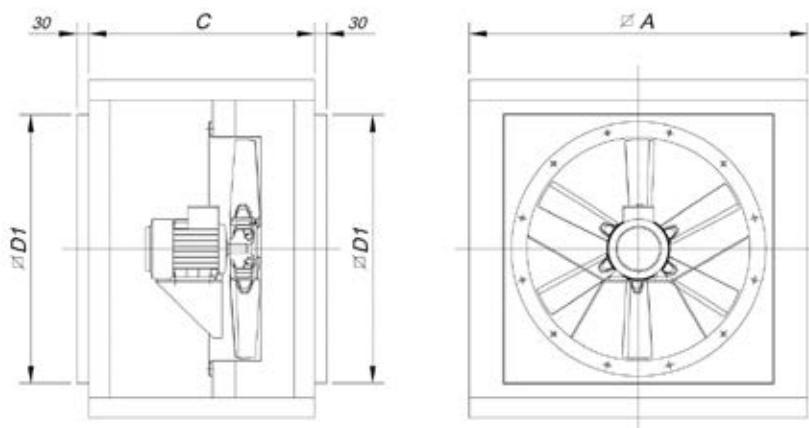

Model	∅A	C	∅D1
CJTHT-40/45/50	700	550	565
CJTHT-56/63	825	550	690
CJTHT-71/80	1000	650	850
CJTHT-90/100	1200	750	1050
CJTHT-125	1600	1200	1400

Characteristic curves

See characteristic curves on page 33.

Accessories

See accessories section



CJTHT/DUPLEX/ATEX



400°C/2h extraction units, with ATEX certification, category 2 Ex II2G In accordance with Spanish Low Voltage Regulation Itc 29 ATEX and NBE-CP/96 for Zone 1 and 2 rated car parks.

Duplex extraction units with soundproofed box to work inside fire danger zones at 400°C/2h, with ATEX certification, category 2 Ex II2G In accordance with Spanish Low Voltage Regulation Itc 29 ATEX for Zone 1 and 2 rated car parks.

Fan:

- Galvanised sheet steel structure with thermal insulation and soundproofing.
- Turnable impellers cast aluminium.
- Duplex extraction units consisting of:
 - CJTHT/ATEX category 3, 400°C/2h to smoke extraction in the event of fire, certificate No.: 0370-CPD-0312
 - CJHCH/ATEX category 2 to CO extraction during normal operation
- Airflow direction from motor to impeller



Motor:

- Class H motors, ongoing use S1 and emergency use S2, with ball bearings and IP55 protection
- Three-phase 230/400V.-50Hz. (up to 4CV) and 400/690V.-50Hz. (power over 4CV.)
- Max. temperature of air for transport: S1 Service -20°C+ 40°C for ongoing use, S2 Service 400°C/2h

Finish:

- Anticorrosive galvanized sheet steel.

On request:

- Built to work in a horizontal position



Order code

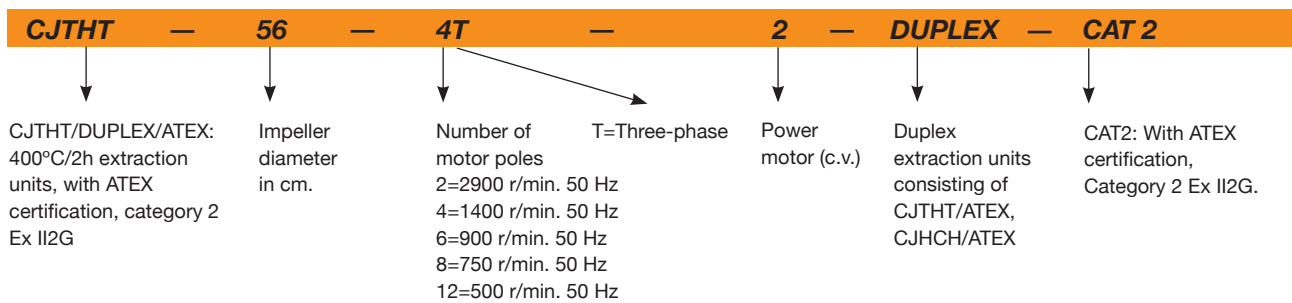

Technical characteristics

Model	Speed (r/min)	Maximum admissible current (A)			Power installed (kW)	Tilting angle blades (°)	Airflow maximum (m³/h)	Sound pressure level dB(A)	Approx. weight (Kg)
		230V	400V	690V					
CJTHT-40-4T-0.75/DUPLEX-CAT2	1420	2.90	1.70		0.55	32	4800	61	82
CJTHT-40-6T-0.75/DUPLEX-CAT2	930	3.30	1.90		0.55	32	3150	51	92
CJTHT-45-4T-0.75/DUPLEX-CAT2	1420	2.90	1.70		0.55	36	7450	65	85
CJTHT-45-6T-0.75/DUPLEX-CAT2	930	3.30	1.90		0.55	30	4450	53	95
CJTHT-50-4T-1/DUPLEX-CAT2	1430	3.80	2.20		0.75	28	9750	66	95
CJTHT-50-6T-0.75/DUPLEX-CAT2	930	3.30	1.90		0.55	32	7000	55	97
CJTHT-56-4T-1/DUPLEX-CAT2	1430	3.80	2.20		0.75	22	11250	70	113
CJTHT-56-4T-1.5/DUPLEX-CAT2	1420	4.70	2.70		1.10	30	13600	71	117
CJTHT-56-4T-2/DUPLEX-CAT2	1425	6.60	3.80		1.50	36	15050	72	122
CJTHT-56-6T-0.75/DUPLEX-CAT2	930	3.30	1.90		0.55	38	10150	60	115

Technical characteristics

Model	Speed (r/min)	Maximum admissible current (A)			Power installed (kW)	Tilting angle blades (°)	Airflow maximum (m³/h)	Sound pressure level dB(A)	Approx. weight (Kg)
		230V	400V	690V					
CJTHT-63-4T-1/DUPLEX-CAT2	1430	3.80	2.20		0.75	14	15200	70	122
CJTHT-63-4T-1.5/DUPLEX-CAT2	1420	4.70	2.70		1.10	20	17800	71	126
CJTHT-63-4T-2/DUPLEX-CAT2	1425	6.60	3.80		1.50	24	19300	72	131
CJTHT-63-4T-3/DUPLEX-CAT2	1435	9.20	5.30		2.20	32	22150	73	143
CJTHT-63-4T-4/DUPLEX-CAT2	1430	11.40	6.60		3.00	38	24250	74	150
CJTHT-63-6T-0.75/DUPLEX-CAT2	930	3.30	1.90		0.55	28	13600	63	124
CJTHT-63-6T-1/DUPLEX-CAT2	940	4.40	2.60		0.75	38	15900	64	128
CJTHT-71-4T-1.5/DUPLEX-CAT2	1420	4.70	2.70		1.10	12	19500	75	160
CJTHT-71-4T-2/DUPLEX-CAT2	1425	6.60	3.80		1.50	14	20900	76	164
CJTHT-71-4T-3/DUPLEX-CAT2	1435	9.20	5.30		2.20	22	25100	78	177
CJTHT-71-4T-4/DUPLEX-CAT2	1430	11.40	6.60		3.00	28	27500	79	184
CJTHT-71-6T-0.75/DUPLEX-CAT2	930	3.30	1.90		0.55	20	16100	65	158
CJTHT-71-6T-1/DUPLEX-CAT2	940	4.40	2.60		0.75	26	17300	66	161
CJTHT-71-6T-1.5/DUPLEX-CAT2	945	6.40	3.70		1.10	34	19950	67	166
CJTHT-80-4T-3/DUPLEX-CAT2	1435	9.20	5.30		2.20	12	25450	79	193
CJTHT-80-4T-4/DUPLEX-CAT2	1430	11.40	6.60		3.00	16	30250	80	200
CJTHT-80-4T-5.5/DUPLEX-CAT2	1440		8.40	4.85	4.00	18	32750	81	213
CJTHT-80-6T-1.5/DUPLEX-CAT2	945	6.40	3.70		1.10	18	21450	70	184
CJTHT-80-6T-2/DUPLEX-CAT2	945	7.40	4.30		1.50	26	25950	71	196
CJTHT-80-6T-3/DUPLEX-CAT2	950	10.30	5.90		2.20	32	29950	72	213
CJTHT-90-4T-4/DUPLEX-CAT2	1430	11.40	6.60		3.00	8	33600	84	248
CJTHT-90-4T-5.5/DUPLEX-CAT2	1440		8.40	4.85	4.00	12	38900	86	261
CJTHT-90-4T-7.5/DUPLEX-CAT2	1430		11.50	6.64	5.50	18	46150	88	309
CJTHT-90-4T-10/DUPLEX-CAT2	1460		17.70	10.22	7.50	22	50150	89	354
CJTHT-90-6T-2/DUPLEX-CAT2	945	7.40	4.30		1.50	16	28800	75	243
CJTHT-90-6T-3/DUPLEX-CAT2	950	10.30	5.90		2.20	24	34000	76	261
CJTHT-90-6T-4/DUPLEX-CAT2	945	15.00	8.70		3.00	30	38900	77	308
CJTHT-100-4T-7.5/DUPLEX-CAT2	1430		11.50	6.64	5.50	10	46850	89	326
CJTHT-100-4T-10/DUPLEX-CAT2	1460		17.70	10.22	7.50	16	57400	90	371
CJTHT-100-4T-15/DUPLEX-CAT2	1455		23.00	13.28	11.00	22	66300	91	436
CJTHT-100-4T-20/DUPLEX-CAT2	1460		29.00	16.74	15.00	28	76150	92	462
CJTHT-100-6T-3/DUPLEX-CAT2	950	10.30	5.90		2.20	16	37600	80	277
CJTHT-100-6T-4/DUPLEX-CAT2	945	15.00	8.70		3.00	20	41150	81	325
CJTHT-100-6T-5.5/DUPLEX-CAT2	970		11.00	6.35	4.00	26	47800	82	340

(*) The information refers to a single fan.

Acoustic features

The specified values are determined according to free field measurements of pressure and sound levels in dB(A) at an equivalent distance of twice the fan's span plus the impeller's diameter, with a minimum of 1.5 m.

Sound power Lw(A) spectrum in dB(A) via frequency band in Hz.

Model	63	125	250	500	1000	2000	4000	8000	Model	63	125	250	500	1000	2000	4000	8000
CJTHT-40-4T-0.75/DUPLEX-CAT2	33	54	61	66	69	65	58	47	CJTHT-71-6T-1/DUPLEX-CAT2	43	63	71	73	75	72	65	54
CJTHT-40-6T-0.75/DUPLEX-CAT2	23	44	51	56	59	55	48	37	CJTHT-71-6T-1.5/DUPLEX-CAT2	44	64	69	74	76	73	66	55
CJTHT-45-4T-0.75/DUPLEX-CAT2	37	58	65	70	73	69	62	51	CJTHT-80-4T-3/DUPLEX-CAT2	56	75	83	89	90	87	81	70
CJTHT-45-6T-0.75/DUPLEX-CAT2	25	46	53	58	61	57	50	39	CJTHT-80-4T-4/DUPLEX-CAT2	54	74	82	87	89	86	79	71
CJTHT-50-4T-1/DUPLEX-CAT2	41	61	69	74	76	73	66	55	CJTHT-80-4T-5.5/DUPLEX-CAT2	54	74	82	87	89	86	79	72
CJTHT-50-6T-0.75/DUPLEX-CAT2	30	50	58	63	65	62	55	44	CJTHT-80-6T-1.5/DUPLEX-CAT2	47	64	72	77	79	76	69	58
CJTHT-56-4T-1/DUPLEX-CAT2	45	65	73	78	80	77	70	59	CJTHT-80-6T-2/DUPLEX-CAT2	48	65	73	78	80	77	70	59
CJTHT-56-4T-1.5/DUPLEX-CAT2	46	66	74	79	81	78	71	60	CJTHT-80-6T-3/DUPLEX-CAT2	49	66	74	79	81	78	71	60
CJTHT-56-4T-2/DUPLEX-CAT2	47	67	75	80	82	79	72	61	CJTHT-90-4T-4/DUPLEX-CAT2	59	80	87	92	95	91	84	76
CJTHT-56-6T-0.75/DUPLEX-CAT2	35	55	63	68	70	67	60	49	CJTHT-90-4T-5.5/DUPLEX-CAT2	58	79	86	91	94	90	83	72
CJTHT-63-4T-1/DUPLEX-CAT2	47	67	75	80	82	79	72	61	CJTHT-90-4T-7.5/DUPLEX-CAT2	57	78	85	90	93	89	82	71
CJTHT-63-4T-1.5/DUPLEX-CAT2	46	66	74	79	81	78	71	62	CJTHT-90-4T-10/DUPLEX-CAT2	56	77	84	89	92	88	81	70
CJTHT-63-4T-2/DUPLEX-CAT2	49	66	74	79	81	78	71	63	CJTHT-90-6T-2/DUPLEX-CAT2	47	68	75	80	83	79	72	61
CJTHT-63-4T-3/DUPLEX-CAT2	50	68	76	81	83	80	75	64	CJTHT-90-6T-3/DUPLEX-CAT2	54	68	75	80	83	79	72	61
CJTHT-63-4T-4/DUPLEX-CAT2	51	69	77	82	84	81	76	65	CJTHT-90-6T-4/DUPLEX-CAT2	55	70	77	82	85	81	74	63
CJTHT-63-6T-0.75/DUPLEX-CAT2	40	58	66	71	73	70	63	54	CJTHT-100-4T-7.5/DUPLEX-CAT2	62	82	90	95	97	94	87	76
CJTHT-63-6T-1/DUPLEX-CAT2	41	60	68	73	75	72	65	55	CJTHT-100-4T-10/DUPLEX-CAT2	60	80	88	93	95	92	85	74
CJTHT-71-4T-1.5/DUPLEX-CAT2	52	72	80	85	87	84	77	66	CJTHT-100-4T-15/DUPLEX-CAT2	59	79	87	92	94	91	84	73
CJTHT-71-4T-2/DUPLEX-CAT2	51	71	79	84	86	83	76	67	CJTHT-100-4T-20/DUPLEX-CAT2	61	81	89	94	96	93	86	75
CJTHT-71-4T-3/DUPLEX-CAT2	55	70	78	83	85	82	75	69	CJTHT-100-6T-3/DUPLEX-CAT2	60	71	79	84	86	83	76	65
CJTHT-71-4T-4/DUPLEX-CAT2	56	71	79	84	86	83	76	70	CJTHT-100-6T-4/DUPLEX-CAT2	61	69	77	82	84	81	74	63
CJTHT-71-6T-0.75/DUPLEX-CAT2	42	62	70	73	75	72	65	54	CJTHT-100-6T-5.5/DUPLEX-CAT2	62	71	79	84	86	83	76	65

Dimensions in mm

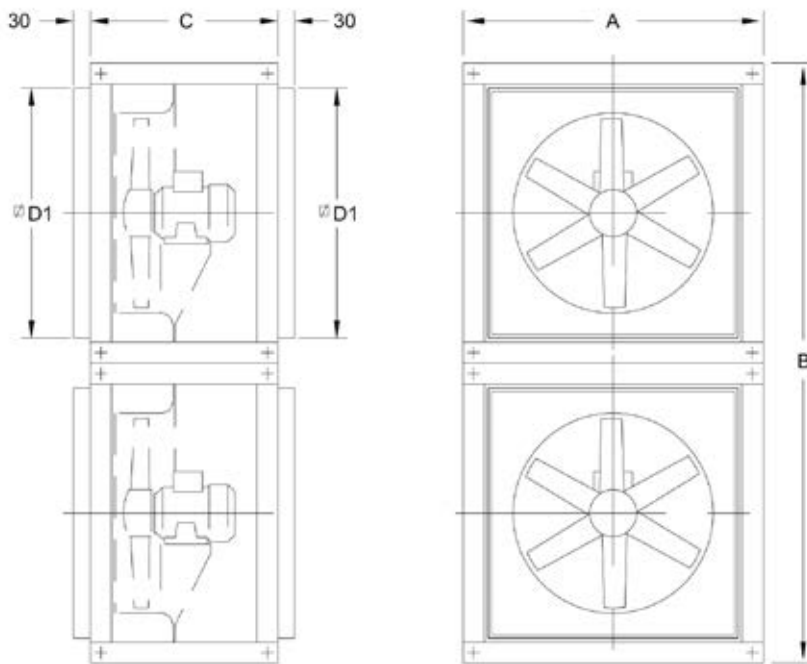

Model	∅A	B	C	∅D1
CJTHT/DUPLEX-40/45/50	700	1400	550	565
CJTHT/DUPLEX-56/63	825	1650	550	690
CJTHT/DUPLEX-71/80	1000	2000	650	850
CJTHT/DUPLEX-90/100	1200	2400	750	1050

Characteristic Curves

See characteristic curves on page 33.

Accessories

See accessories section



EXAMPLE OF SELECTION

Characteristic curves

THT CJTHT/PLUS CJTHT CJTHT/DUPLEX/ATEX:

Q = Airflow in m³/h, m³/s and cfm.

Pe = Static pressure in mm.w.c., Pa and inwg.

Impeller diameter (cm): 71

Number of poles: 6

Number of blades: 6

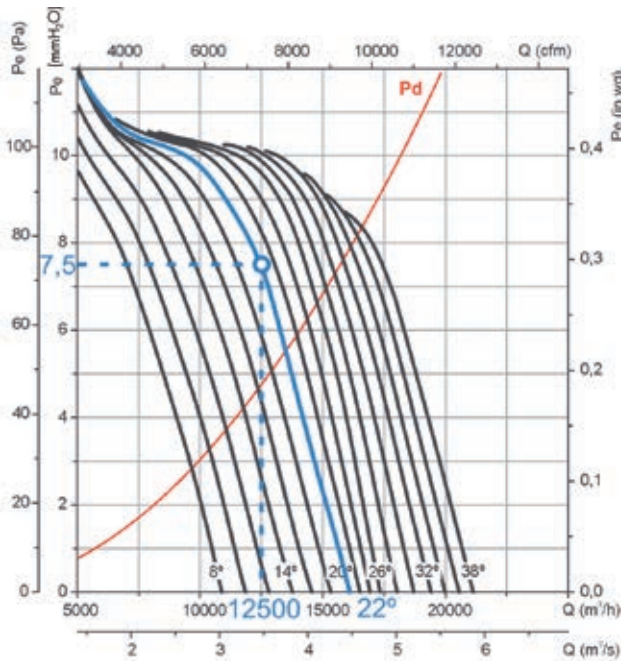

Initial data

- Working point:
- Airflow: 12,500 m³/h
- Loss of load: 7.5 mm w.c.

Steps for the selection of equipment

On the pressure graph:

1. Mark the working point, defined by the airflow (12,500 m³/h) and the loss of load (7.5 mm w.c.).
2. Select the curve of the equipment which is closest above the working point. In our case, a curve with a blade angle of 22° is obtained.

On the power graph:

3. Mark the working point, defined by the airflow (12,500 m³/h) and the selected blade angle (22°).
4. Read the absorbed power on the power axis on the left. Pa= 560 W at the working point.
5. Look for the straight red line which is closest to the working point above. On the right-hand side of the graph, the value of the installed motor power is obtained. In our case, this is 0.75 kW or 1 CV.

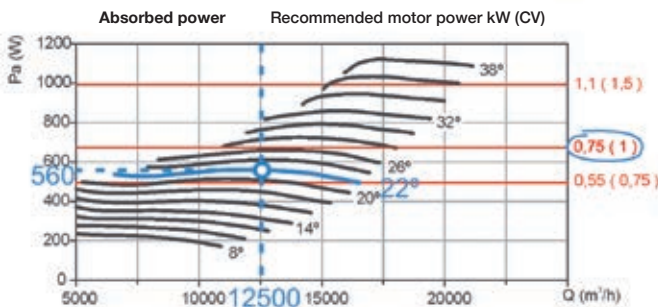

EXAMPLE OF ORDER CODE

THT — 71 — 6T — 1 — 6-22 — F-400

Name of series:

THT
CJTHT/PLUS
CJTHT
CJTHT/DUPLEX/ATEX

Impeller diameter in cm.

Number of motor poles

2=2900 r/min. 50 Hz
4=1400 r/min. 50 Hz
6=900 r/min. 50 Hz
8=750 r/min. 50 Hz
12=500 r/min. 50 Hz

T=Three-phase
M=Single-phase

Motor power (c.v.)

Number of blades:
3 blades
6 blades
9 blades

Angle of inclination of the blades

F-200 Officially approved

200°C/2h

F-300 Officially approved

300°C/2h

F-400 Officially approved

400°C/2h

CAT3: With ATEX certification,

Category 3 Ex II3G.

Characteristic curves

THT CJTHT/PLUS CJTHT CJTHT/DUPLEX/ATEX

Q = Airflow in m³/h, m³/s and cfm.

Pe = Static pressure in mm.w.c., Pa and inwg.

Impeller diameter (cm): 40 Number of poles: 2 Number of blades: 6

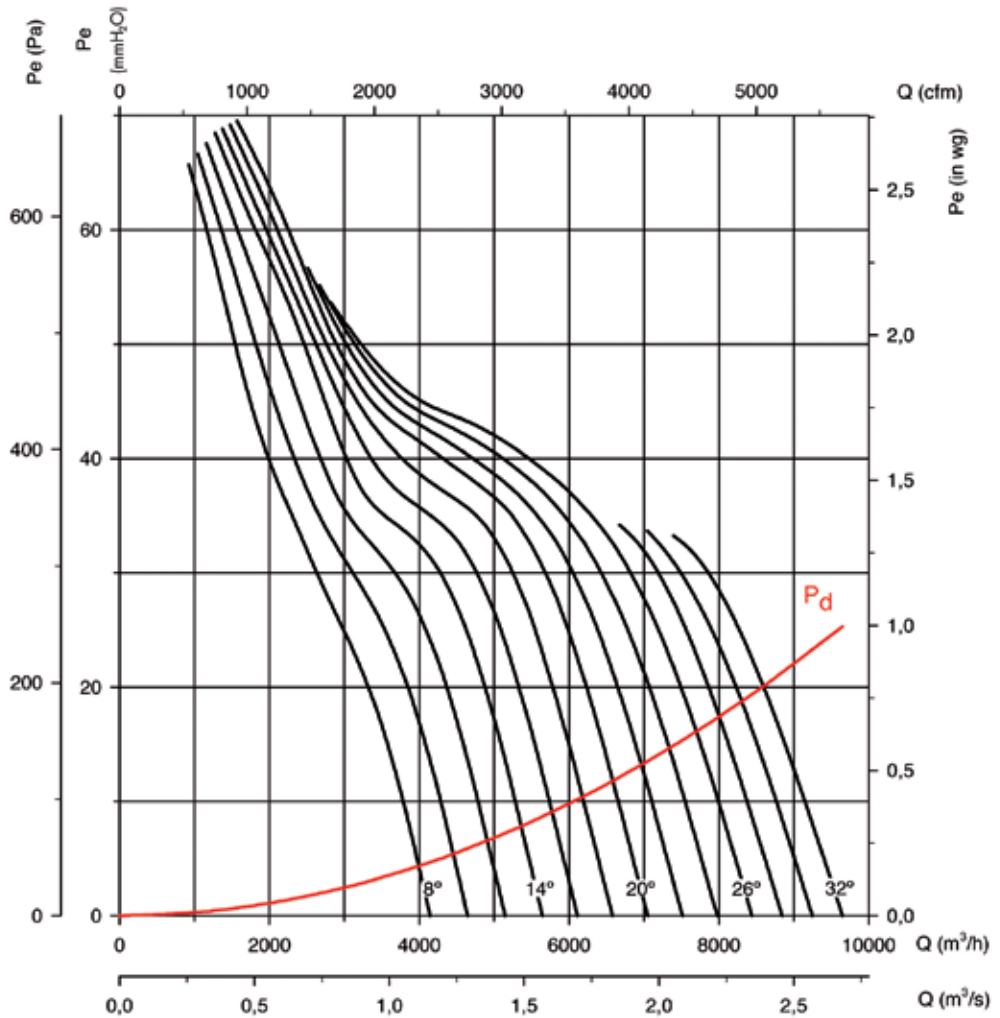

Absorbed power Recommended motor power kW (CV)

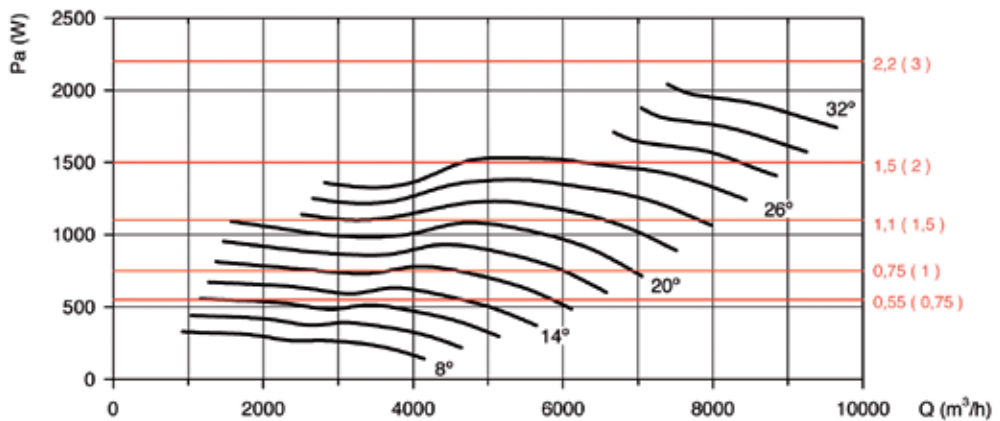

Available features best efficiency point (BEP) at the end of the series.

THT CJTHT/PLUS CJTHT CJTHT/DUPLEX/ATEX

Characteristic curves

THT CJTHT/PLUS CJTHT CJTHT/DUPLEX/ATEX:

Q = Airflow in m³/h, m³/s and cfm.

Pe = Static pressure in mm.w.c., Pa and inwg.

Impeller diameter (cm): 40

Number of poles: 4

Number of blades: 6

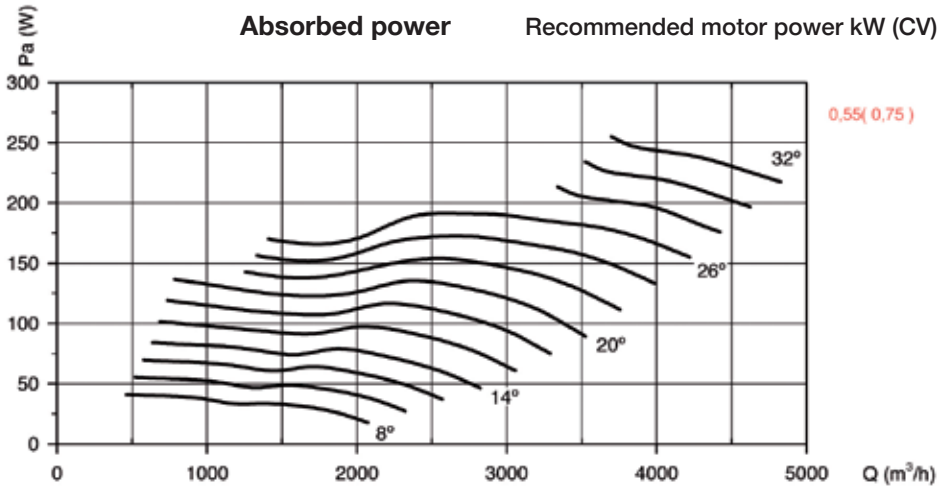
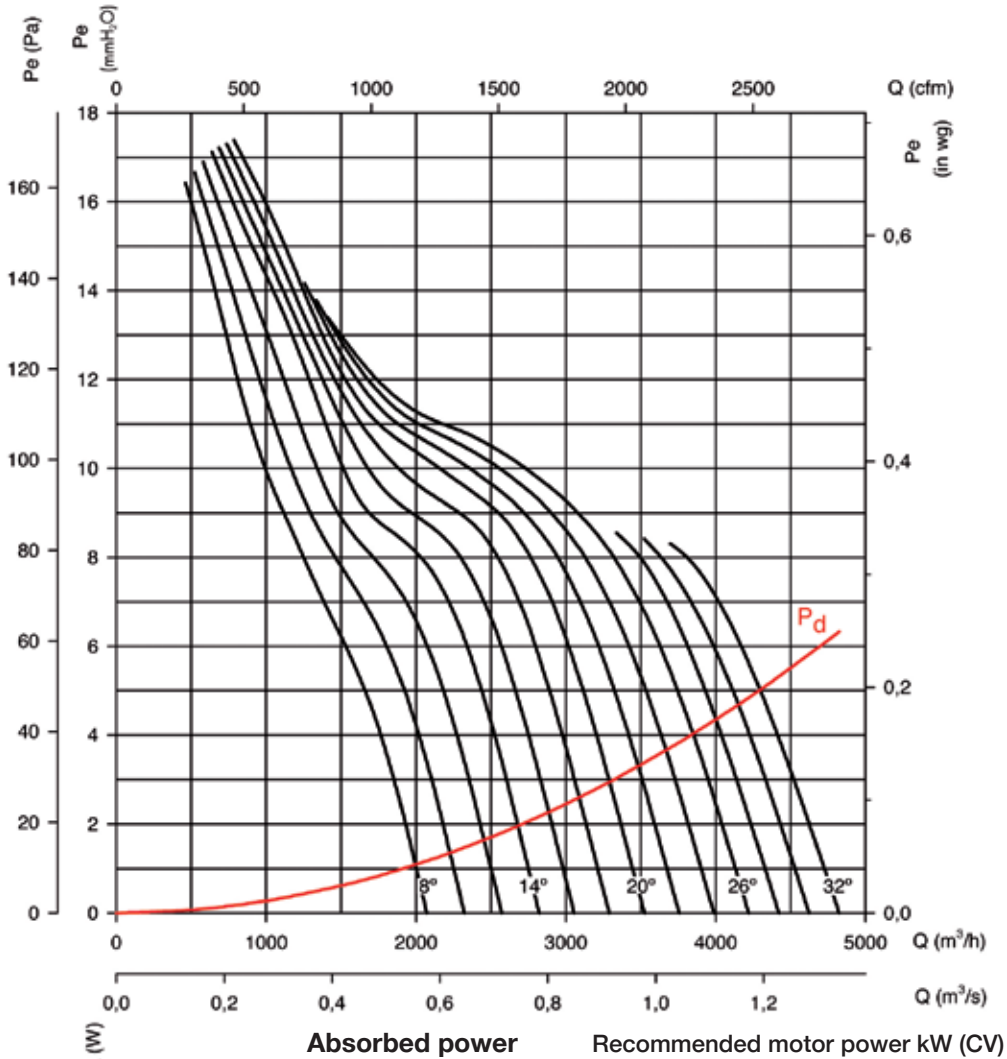

Available features best efficiency point (BEP) at the end of the series.

Characteristic curves

THT CJTHT/PLUS CJTHT CJTHT/DUPLEX/ATEX:

Q = Airflow in m³/h, m³/s and cfm.

Pe = Static pressure in mm.w.c., Pa and inwg.

Impeller diameter (cm): 40

Number of poles: 6

Number of blades: 6

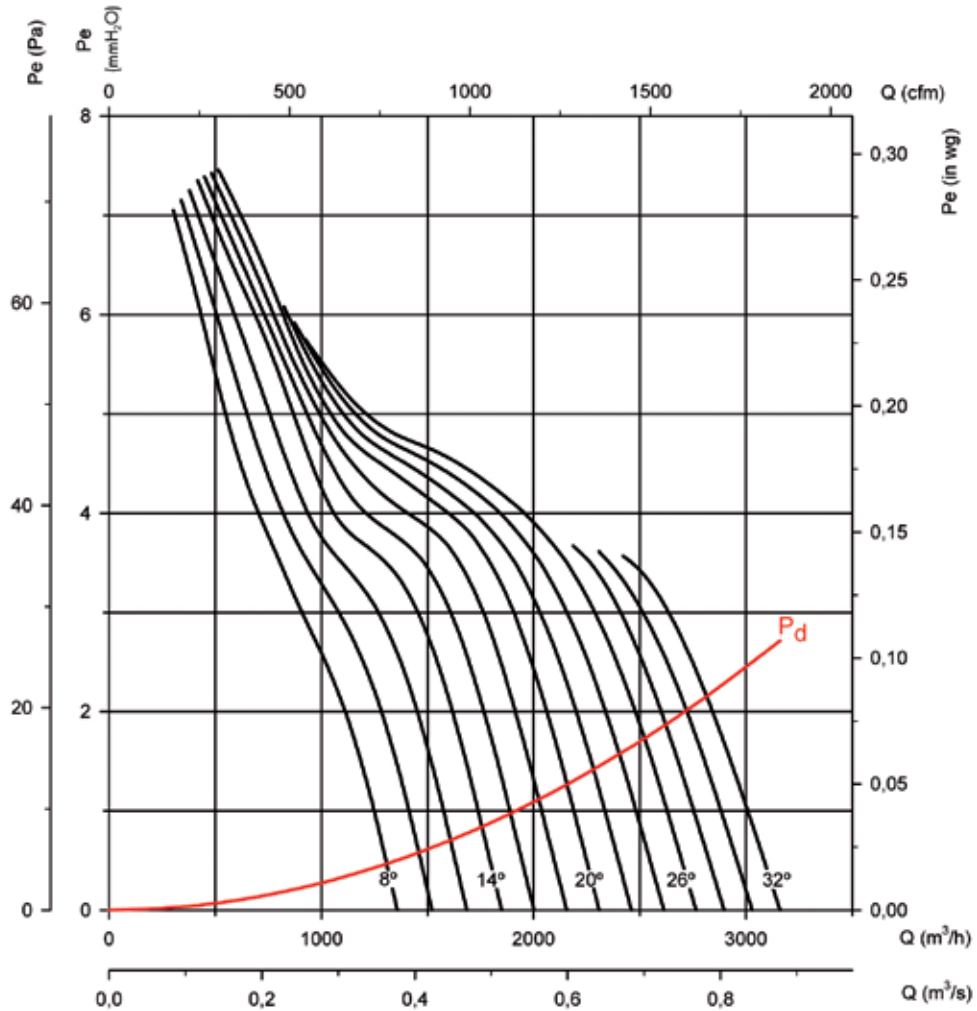

Absorbed power

Recommended motor power kW (CV)

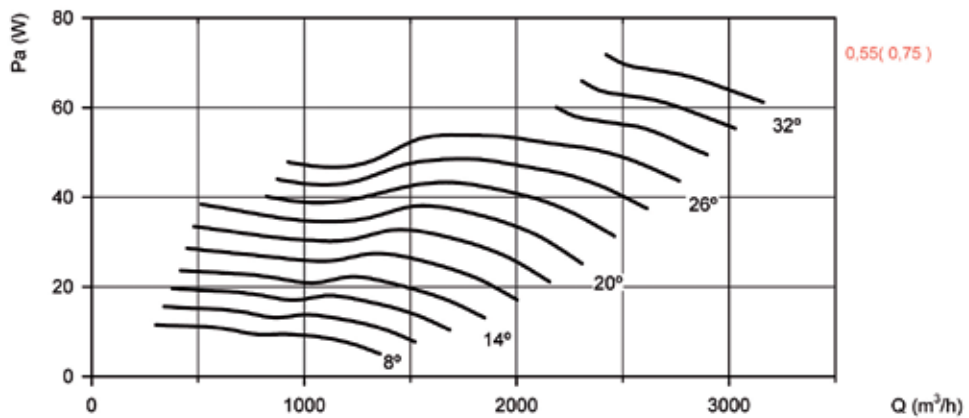

Available features best efficiency point (BEP) at the end of the series.

THT CJTHT/PLUS CJTHT CJTHT/DUPLEX/ATEX

Characteristic curves

THT CJTHT/PLUS CJTHT CJTHT/DUPLEX/ATEX

Q = Airflow in m³/h, m³/s and cfm.

Pe = Static pressure in mm.w.c., Pa and inwg.

Impeller diameter (cm): 45

Number of poles: 2

Number of blades: 6

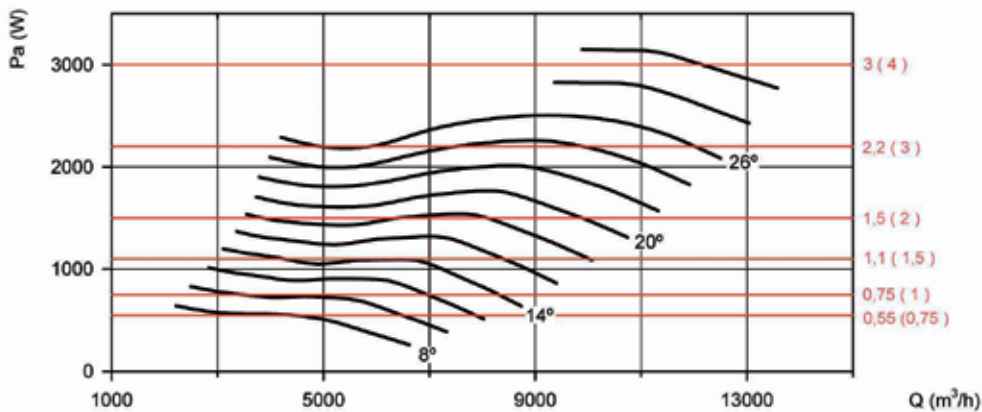
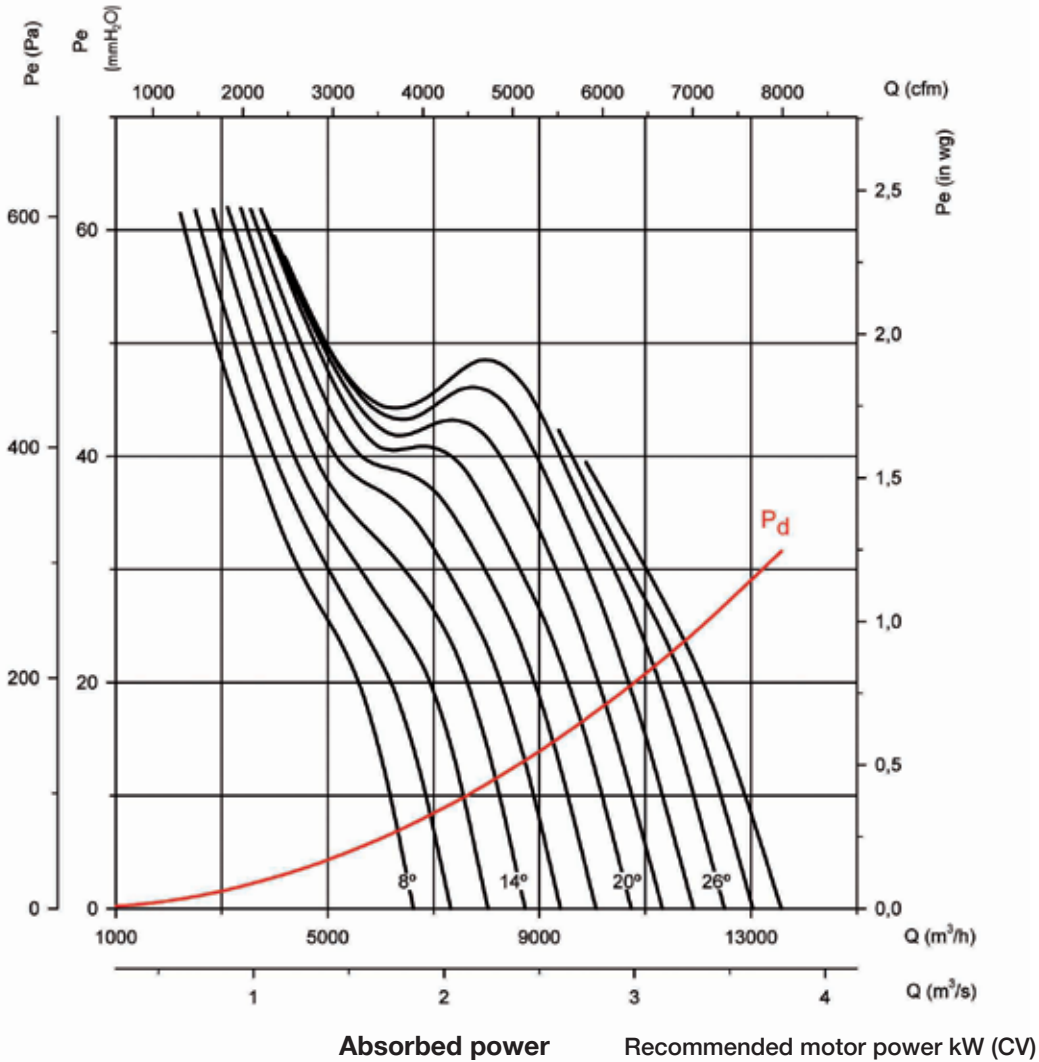

Available features best efficiency point (BEP) at the end of the series.

Characteristic curves

THT CJTHT/PLUS CJTHT CJTHT/DUPLEX/ATEX:

Q = Airflow in m³/h, m³/s and cfm.

Pe = Static pressure in mm.w.c., Pa and inwg.

Impeller diameter (cm): 45

Number of poles: 4

Number of blades: 6

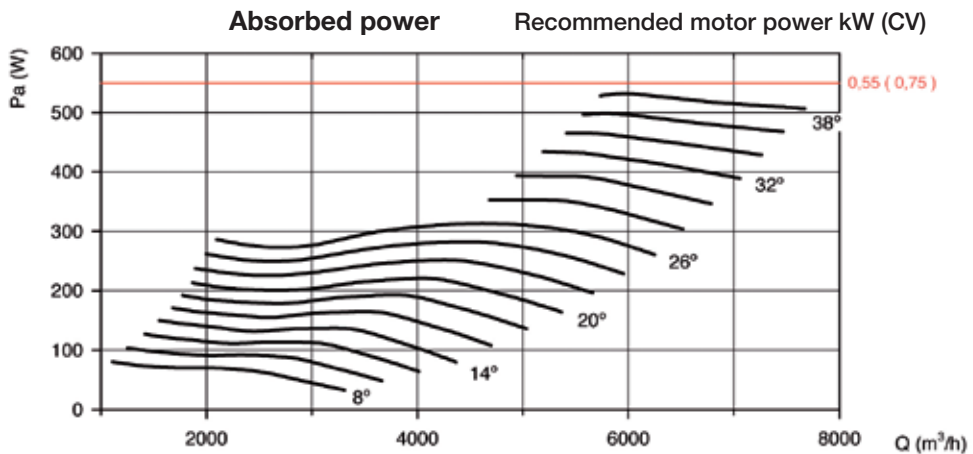
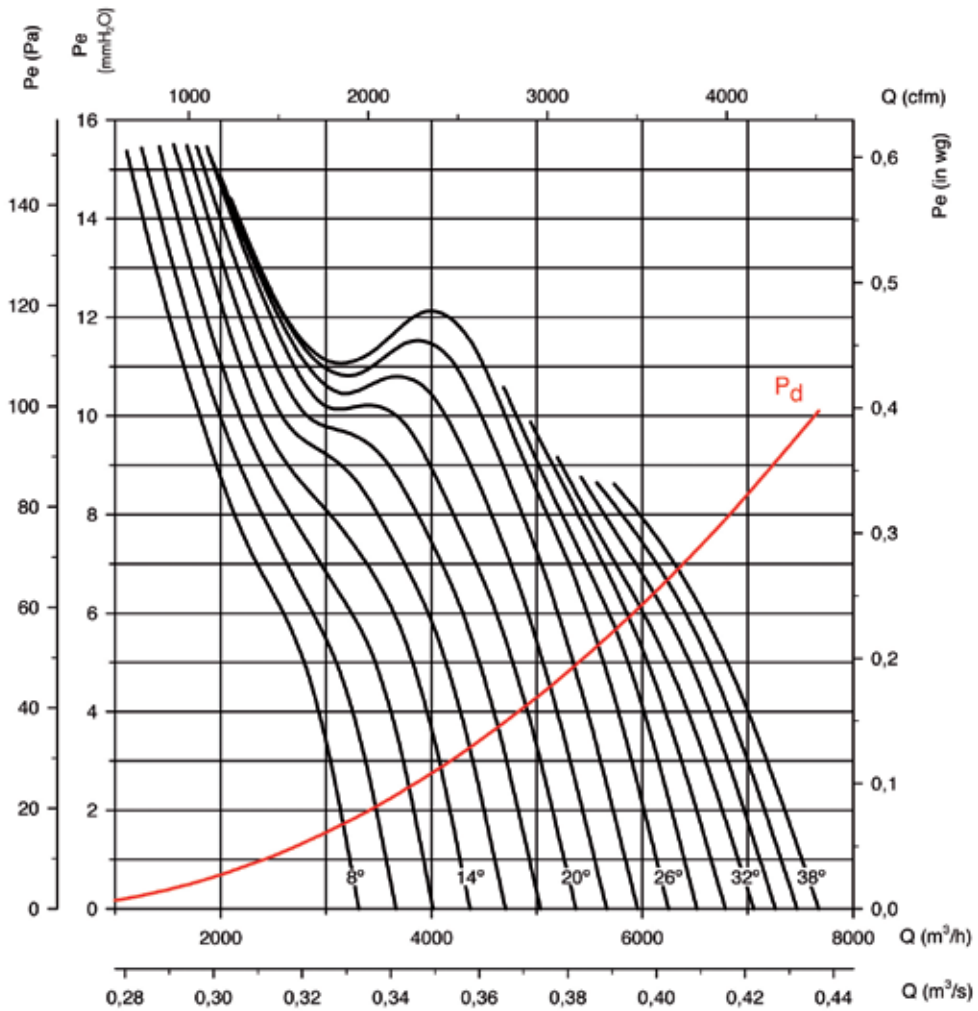

Available features best efficiency point (BEP) at the end of the series.

THT CJTHT/PLUS CJTHT CJTHT/DUPLEX/ATEX

Characteristic curves

THT CJTHT/PLUS CJTHT CJTHT/DUPLEX/ATEX:

Q = Airflow in m³/h, m³/s and cfm.

Pe = Static pressure in mm.w.c., Pa and inwg.

Impeller diameter (cm): 45

Number of poles: 6

Number of blades: 6

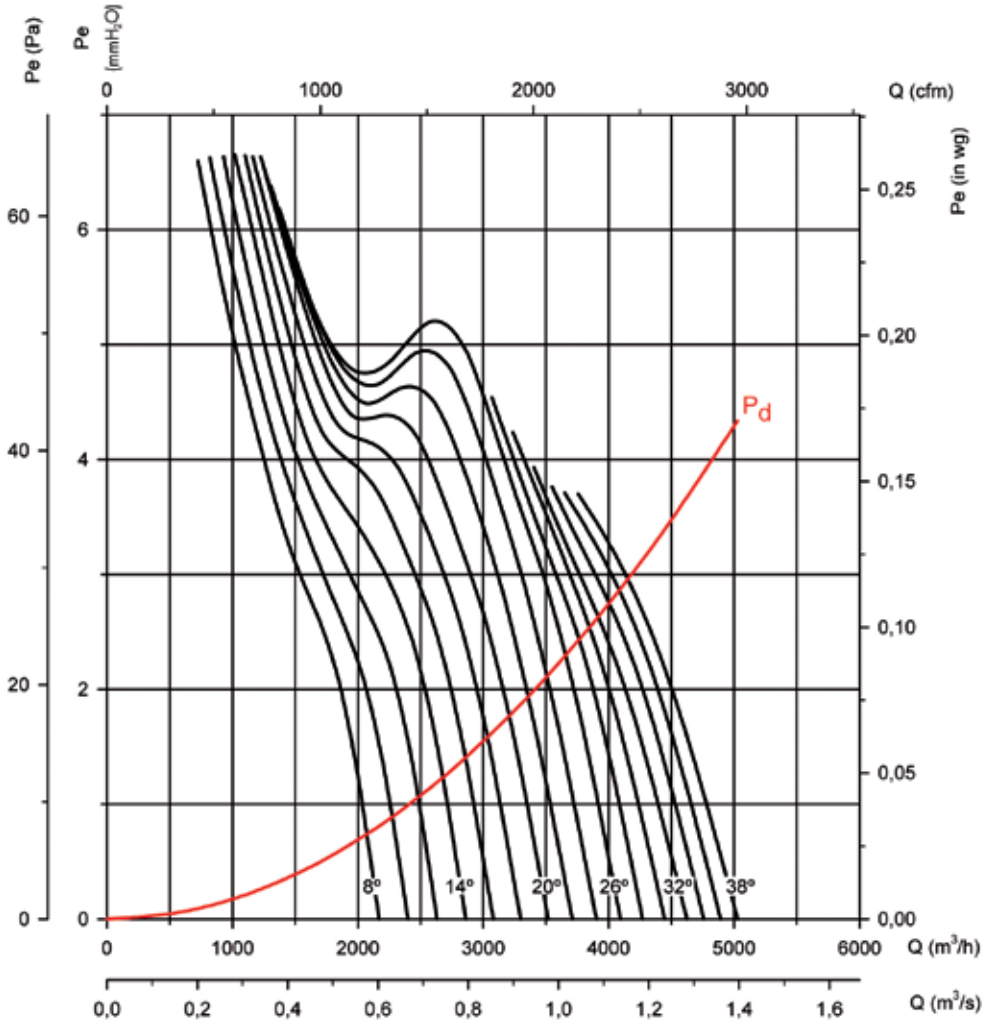

Absorbed power

Recommended motor power kW (CV)

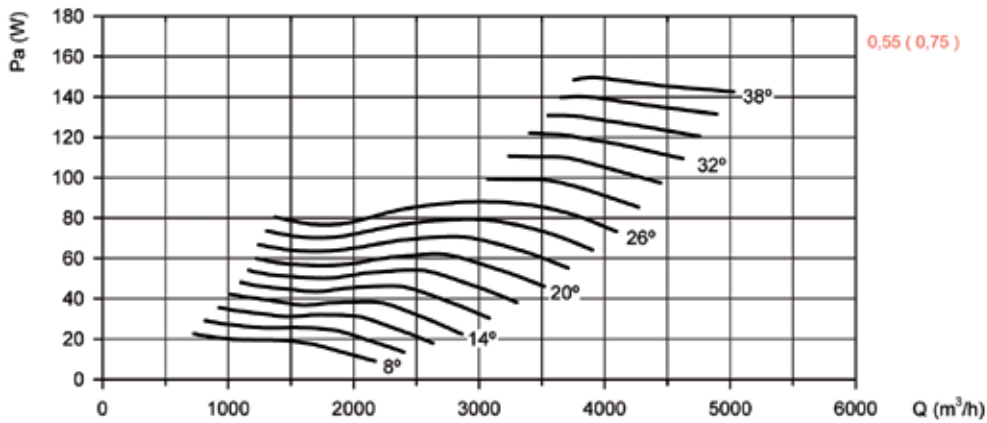

Available features best efficiency point (BEP) at the end of the series.

Characteristic curves

THT CJTHT/PLUS CJTHT CJTHT/DUPLEX/ATEX

Q = Airflow in m³/h, m³/s and cfm.

Pe = Static pressure in mm.w.c., Pa and inwg.

Impeller diameter (cm): 50

Number of poles: 2

Number of blades: 6

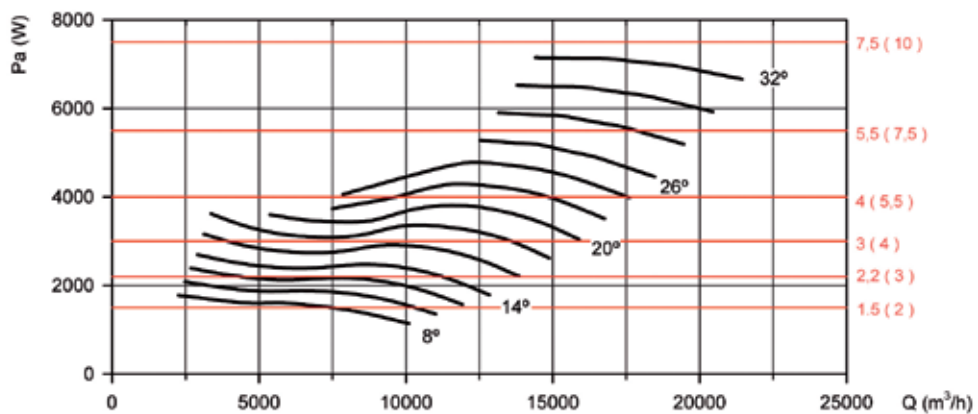
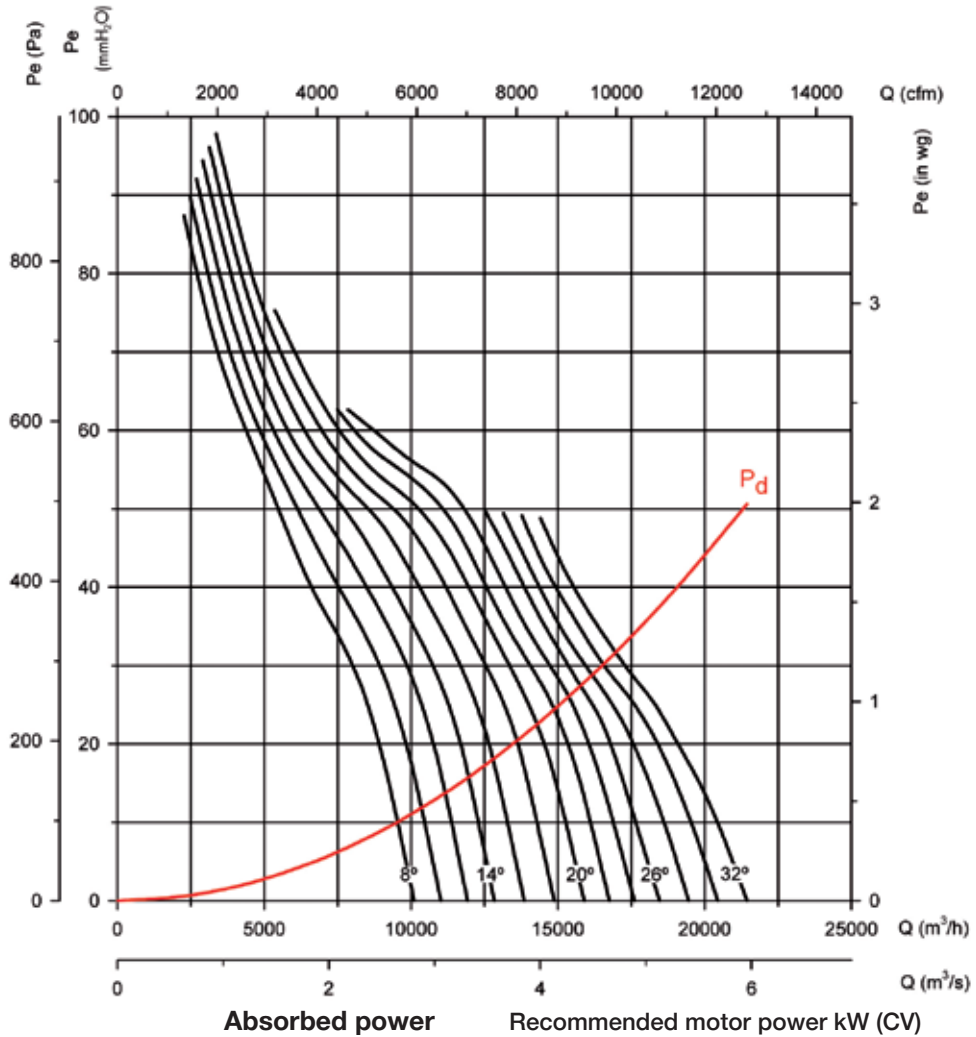

Available features best efficiency point (BEP) at the end of the series.

THT CJTHT/PLUS CJTHT CJTHT/DUPLEX/ATEX

Characteristic curves

THT CJTHT/PLUS CJTHT CJTHT/DUPLEX/ATEX

Q = Airflow in m³/h, m³/s and cfm.

Pe = Static pressure in mm.w.c., Pa and inwg.

Impeller diameter (cm): 50

Number of poles: 4

Number of blades: 6

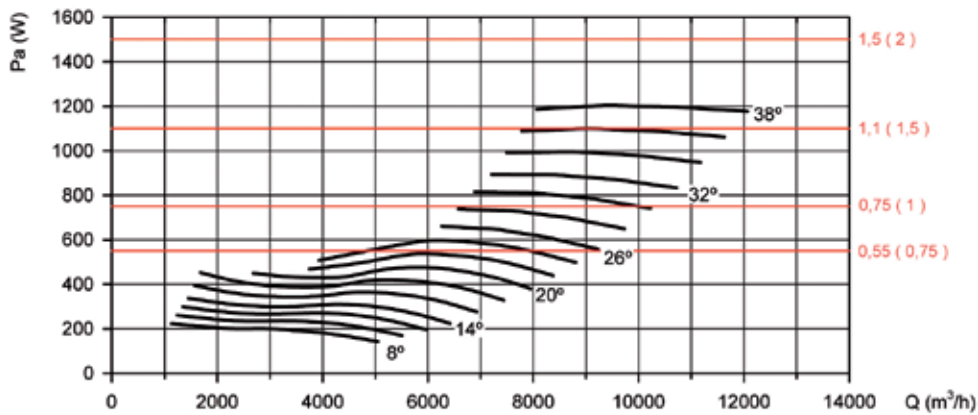
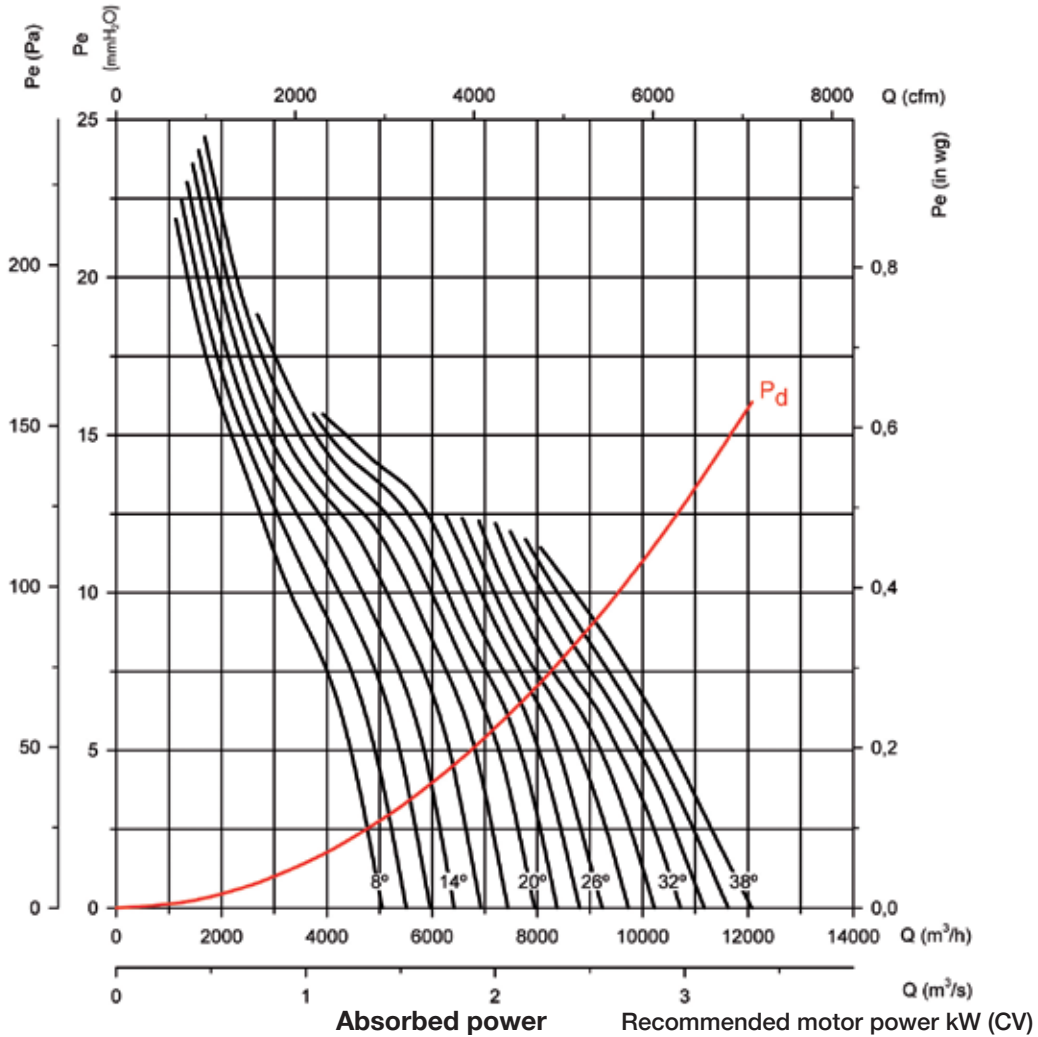

Available features best efficiency point (BEP) at the end of the series.

Characteristic curves

THT CJTHT/PLUS CJTHT CJTHT/DUPLEX/ATEX

Q = Airflow in m³/h, m³/s and cfm.

Pe = Static pressure in mm.w.c., Pa and inwg.

Impeller diameter (cm): 50

Number of poles 6

Number of blades: 6

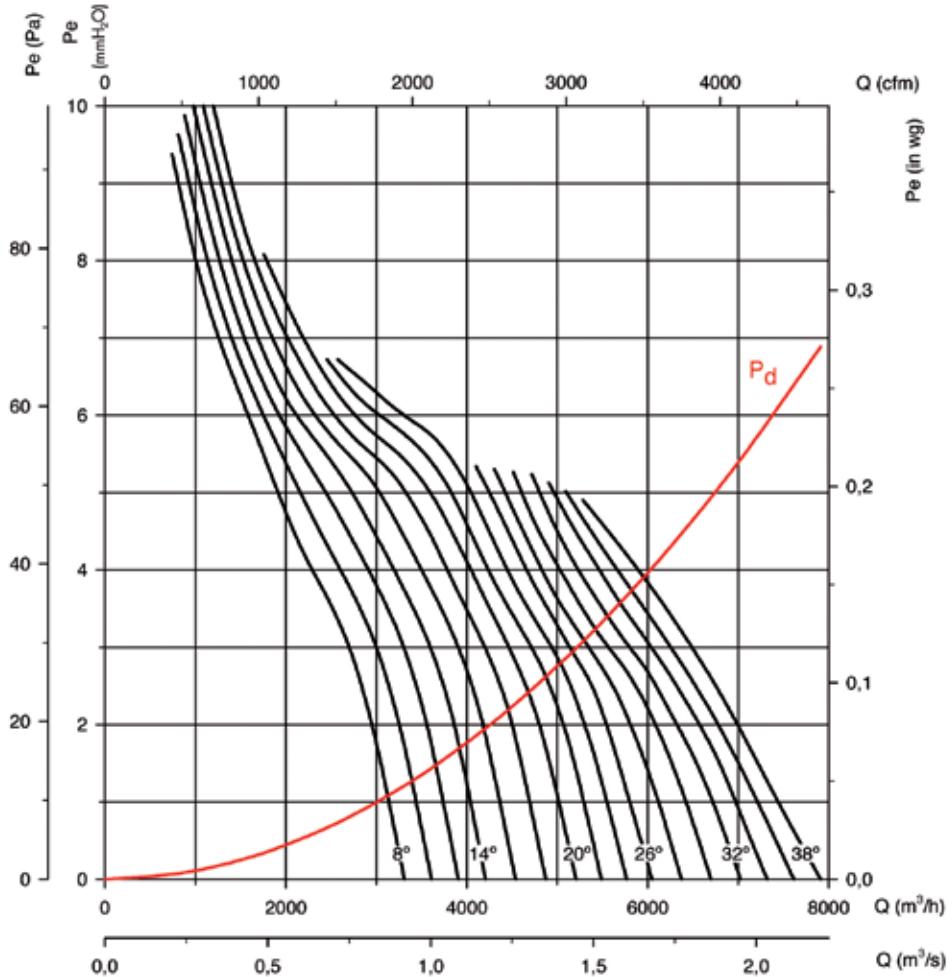

Absorbed power

Recommended motor power kW (CV)

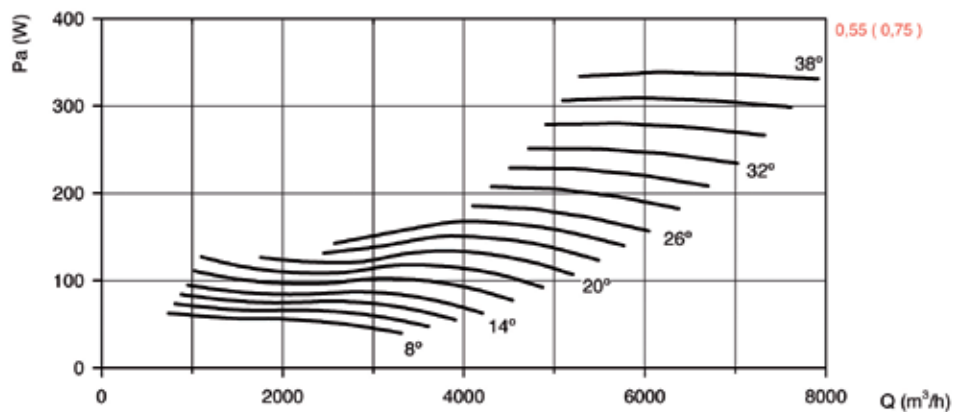

Available features best efficiency point (BEP) at the end of the series.

THT CJTHT/PLUS CJTHT CJTHT/DUPLEX/ATEX

Characteristic curves

THT CJTHT/PLUS CJTHT CJTHT/DUPLEX/ATEX

Q = Airflow in m³/h, m³/s and cfm.

Pe = Static pressure in mm.w.c., Pa and inwg.

Impeller diameter (cm): 56

Number of poles: 2

Number of blades: 6

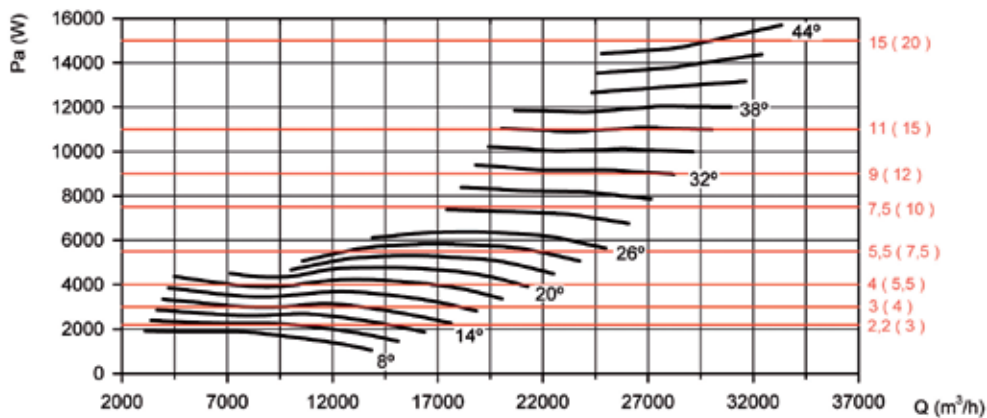
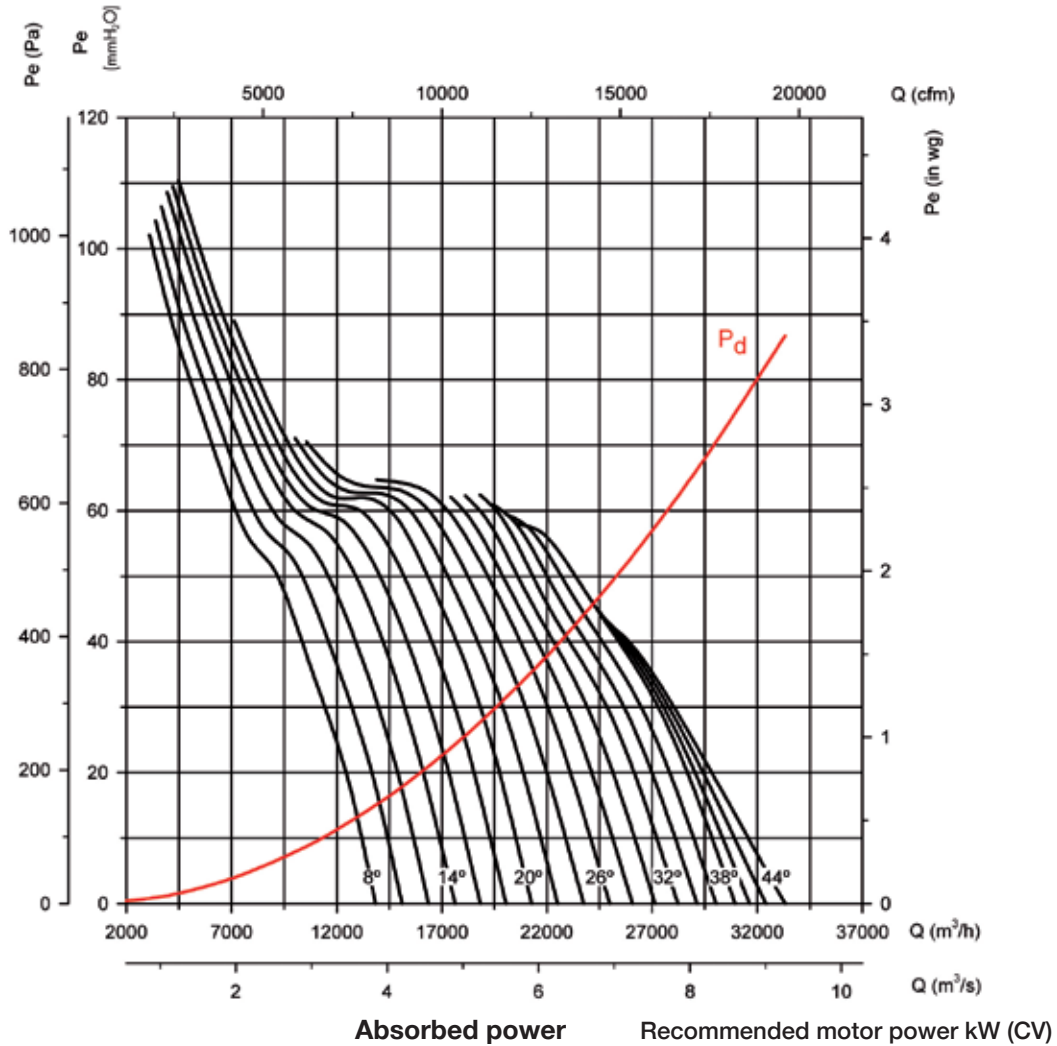

Available features best efficiency point (BEP) at the end of the series.

Characteristic curves

THT CJTHT/PLUS CJTHT CJTHT/DUPLEX/ATEX

Q = Airflow in m³/h, m³/s and cfm.

Pe = Static pressure in mm.w.c., Pa and inwg.

Impeller diameter (cm): 56

Number of poles: 4

Number of blades: 6

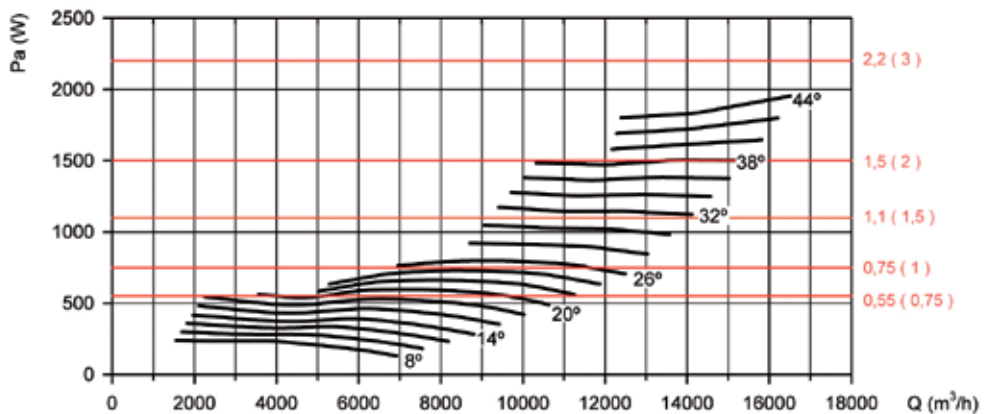
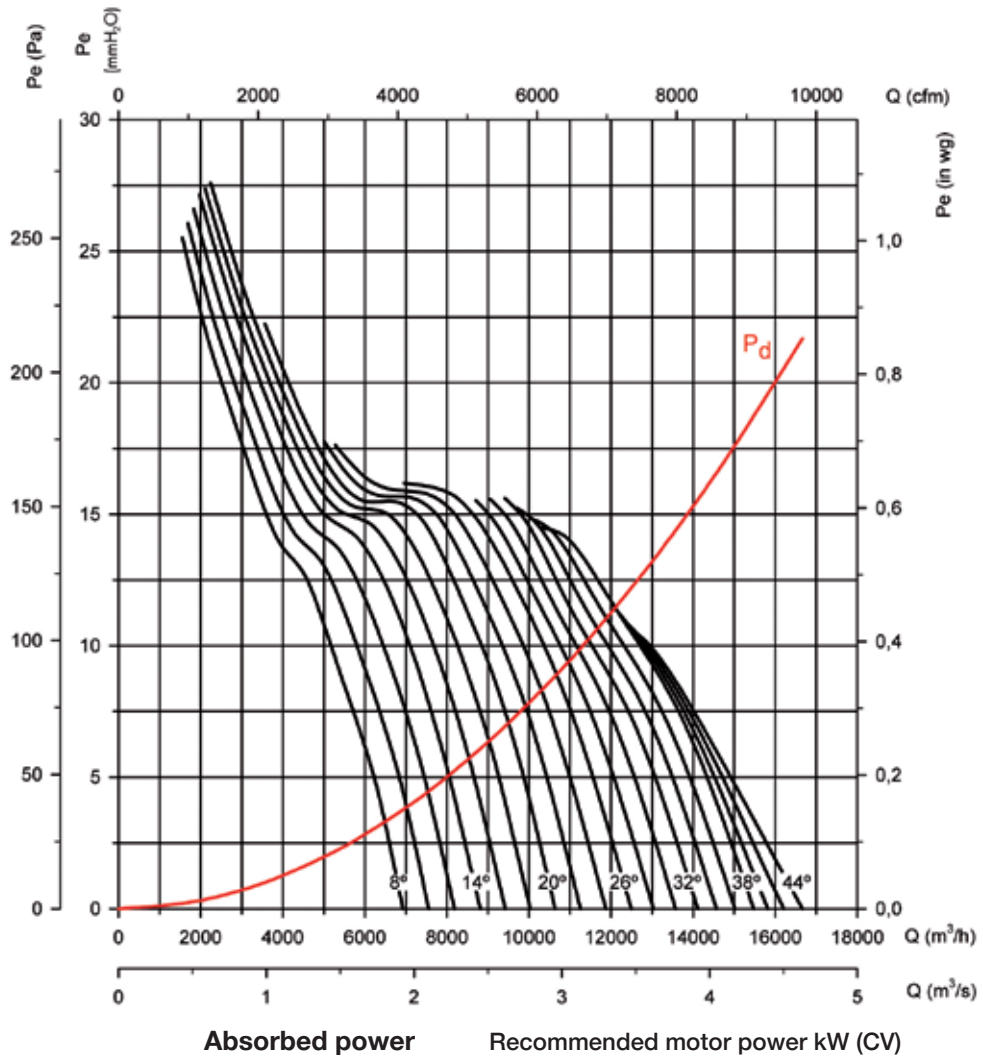

Available features best efficiency point (BEP) at the end of the series.

THT CJTHT/PLUS CJTHT CJTHT/DUPLEX/ATEX

Characteristic curves

THT CJTHT/PLUS CJTHT CJTHT/DUPLEX/ATEX

Q = Airflow in m³/h, m³/s and cfm.

Pe = Static pressure in mm.w.c., Pa and inwg.

Impeller diameter (cm): 56

Number of poles: 6

Number of blades: 6

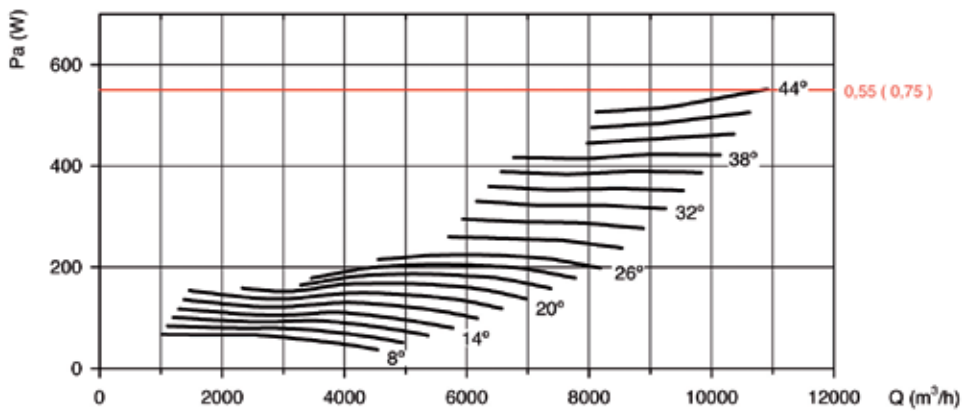
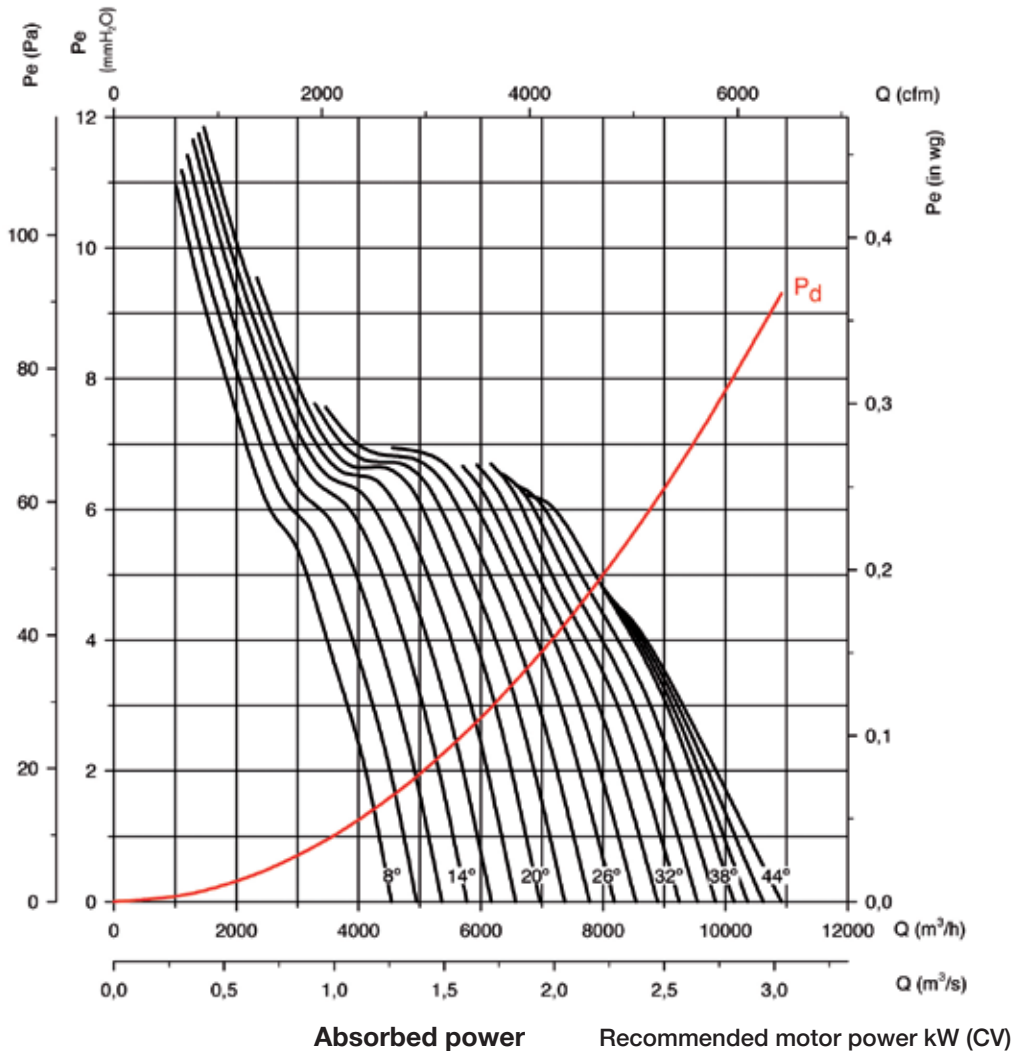

Available features best efficiency point (BEP) at the end of the series.

Characteristic curves

THT CJTHT/PLUS CJTHT CJTHT/DUPLEX/ATEX

Q = Airflow in m³/h, m³/s and cfm.

Pe = Static pressure in mm.w.c., Pa and inwg.

Impeller diameter (cm): 63

Number of poles: 2

Number of blades: 6

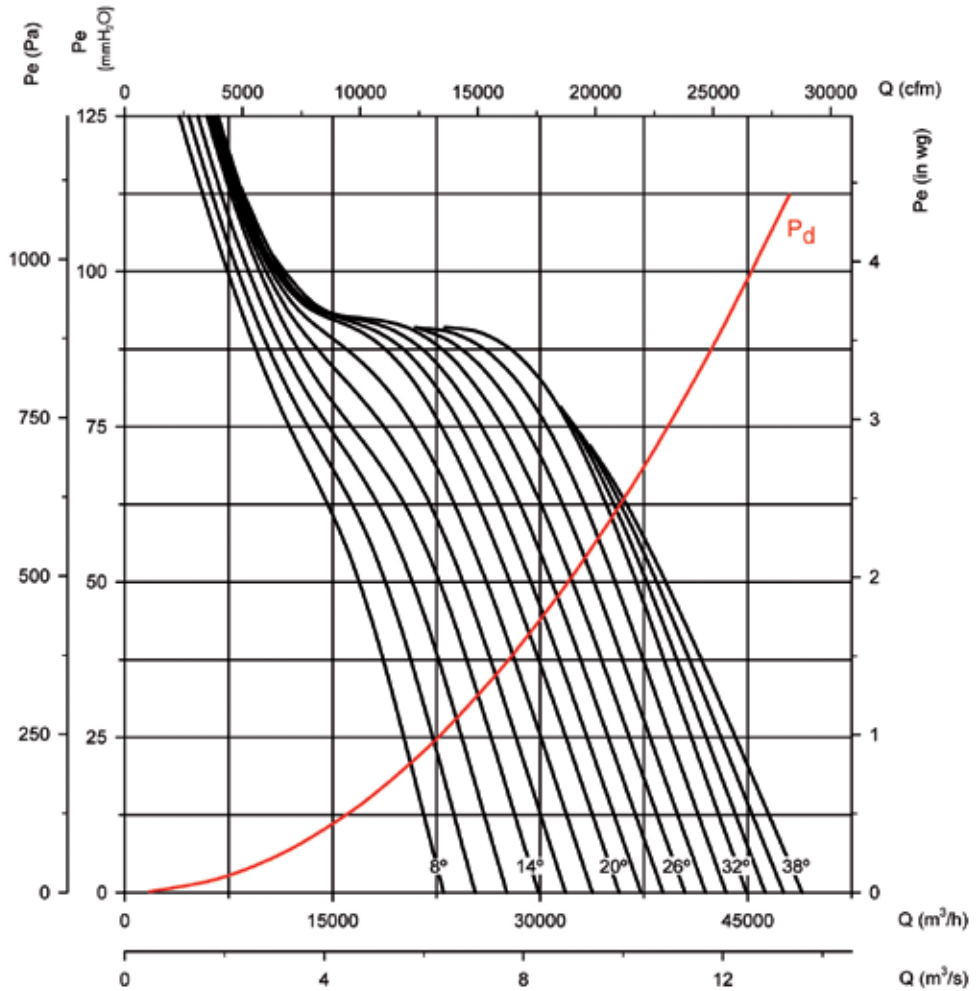

Absorbed power

Recommended motor power kW (CV)

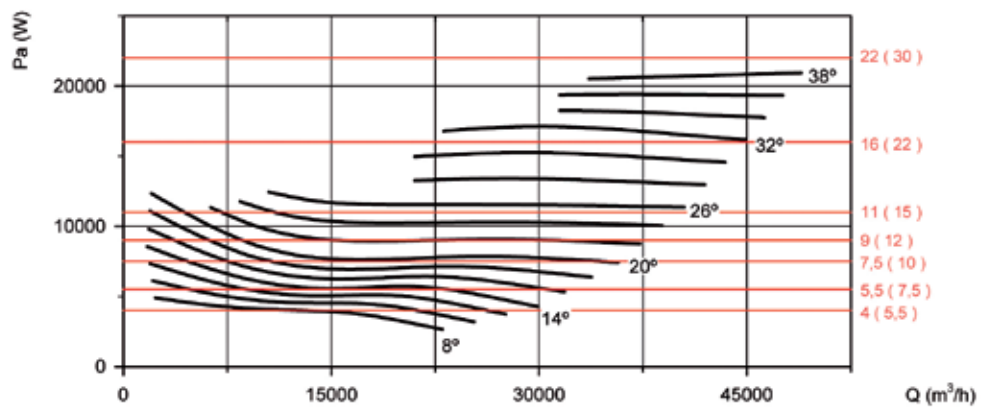

Available features best efficiency point (BEP) at the end of the series.

THT CJTHT/PLUS CJTHT CJTHT/DUPLEX/ATEX

Characteristic curves

THT

CJTHT/PLUS

CJTHT

CJTHT/DUPLEX/ATEX

Q = Airflow in m³/h, m³/s and cfm.

Pe = Static pressure in mm.w.c., Pa and inwg.

Impeller diameter (cm): 63

Number of poles: 4

Number of blades: 6

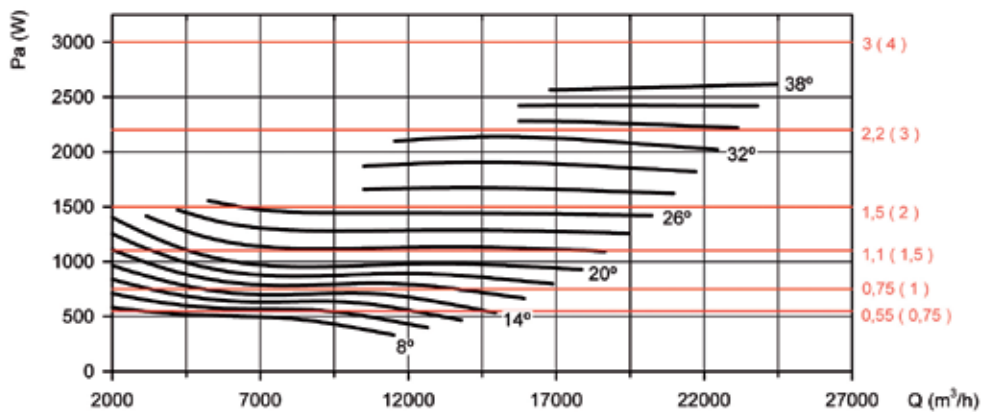
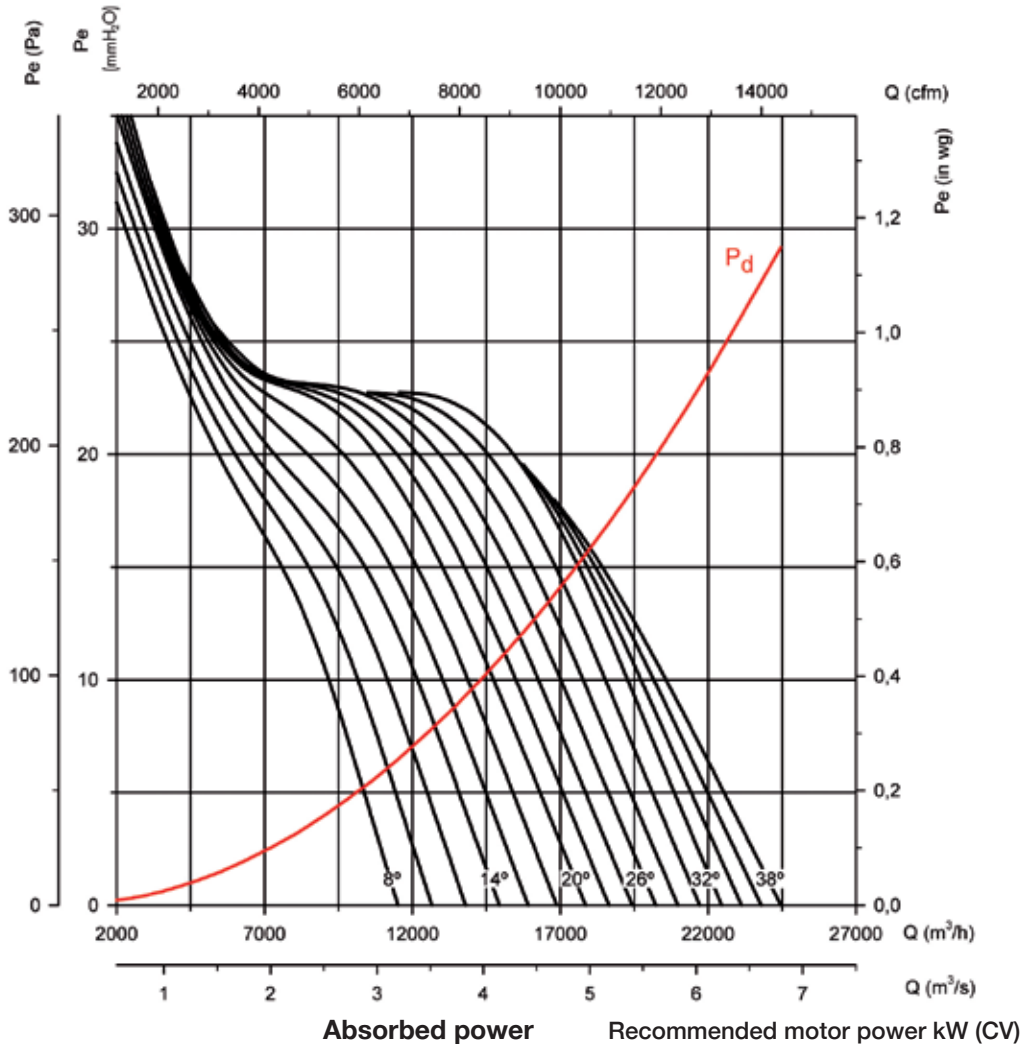

Available features best efficiency point (BEP) at the end of the series.

Characteristic curves

THT

CJTHT/PLUS

CJTHT

CJTHT/DUPLEX/ATEX

Q = Airflow in m³/h, m³/s and cfm.

Pe = Static pressure in mm.w.c., Pa and inwg.

Impeller diameter (cm): 63

Number of poles: 6

Number of blades: 6

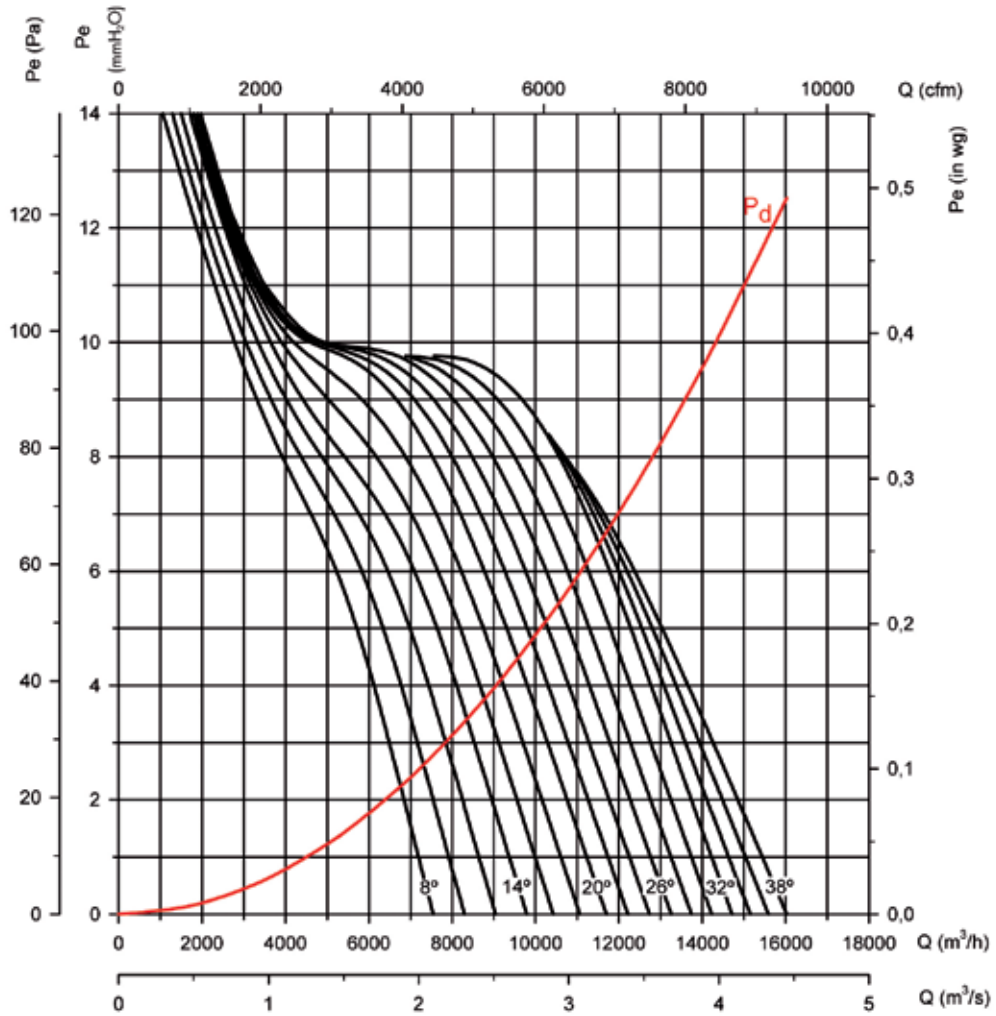

Absorbed power

Recommended motor power kW (CV)

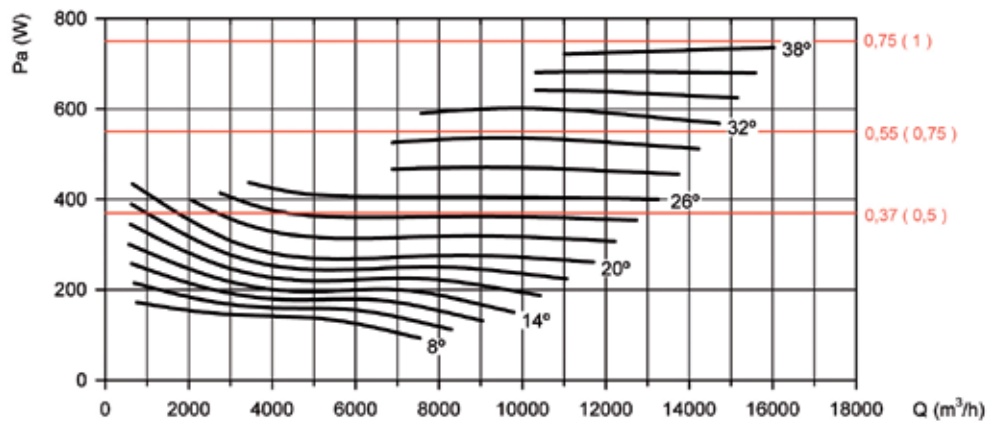

Available features best efficiency point (BEP) at the end of the series.

THT CJTHT/PLUS CJTHT CJTHT/DUPLEX/ATEX

Characteristic curves

THT

CJTHT/PLUS

CJTHT

CJTHT/DUPLEX/ATEX

Q = Airflow in m³/h, m³/s and cfm.

Pe = Static pressure in mm.w.c., Pa and inwg.

Impeller diameter (cm): 71

Number of poles: 4

Number of blades: 6

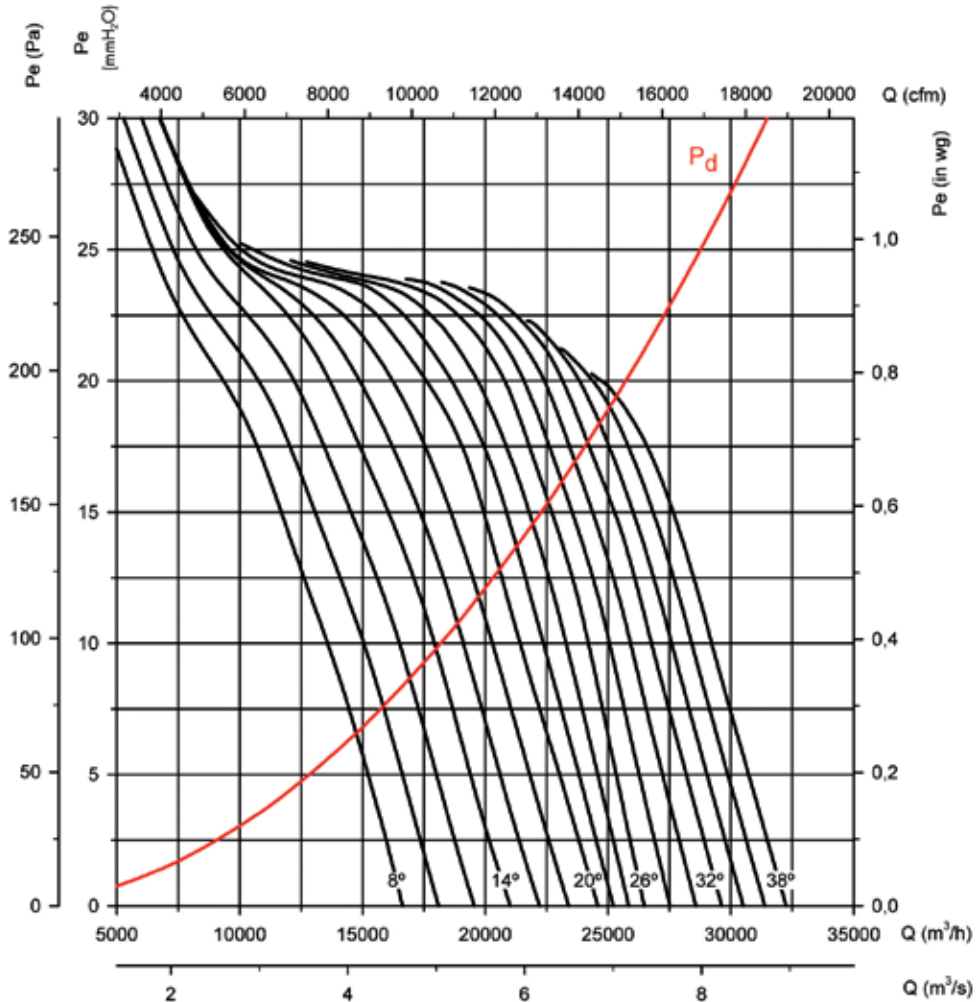

Absorbed power

Recommended motor power kW (CV)

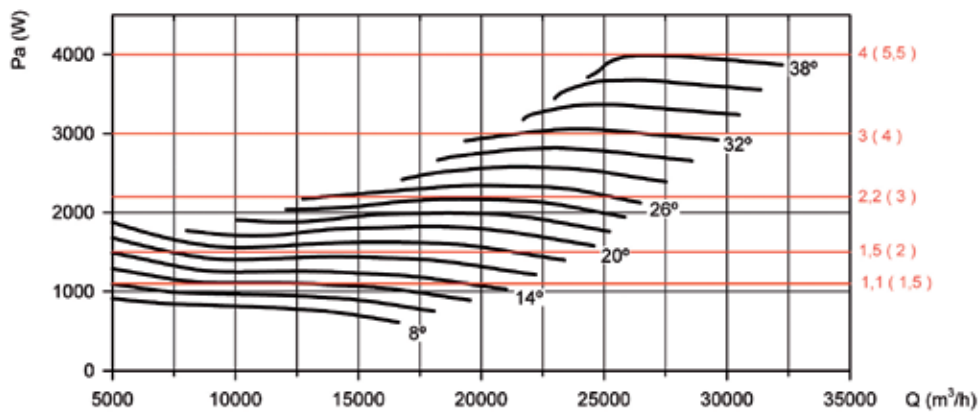

Available features best efficiency point (BEP) at the end of the series.

Characteristic curves

THT CJTHT/PLUS CJTHT CJTHT/DUPLEX/ATEX

Q = Airflow in m³/h, m³/s and cfm.

Pe = Static pressure in mm.w.c., Pa and inwg.

Impeller diameter (cm): 71 Number of poles: 6 Number of blades: 6

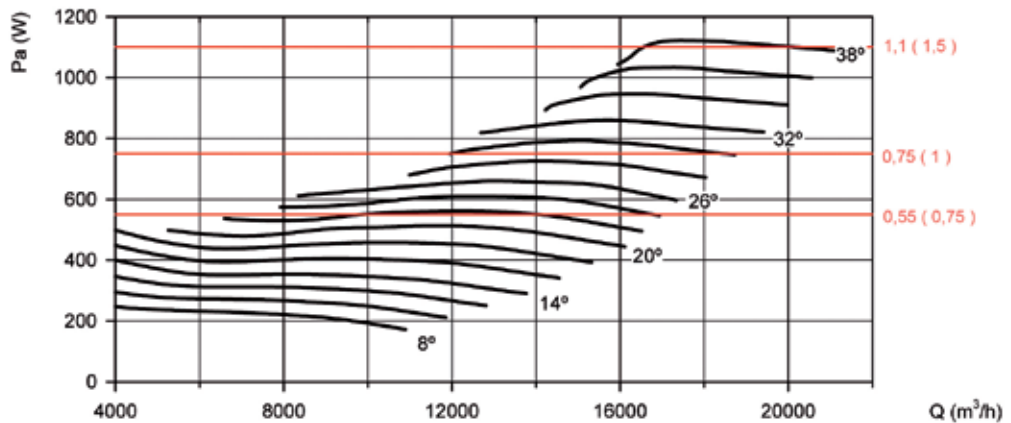
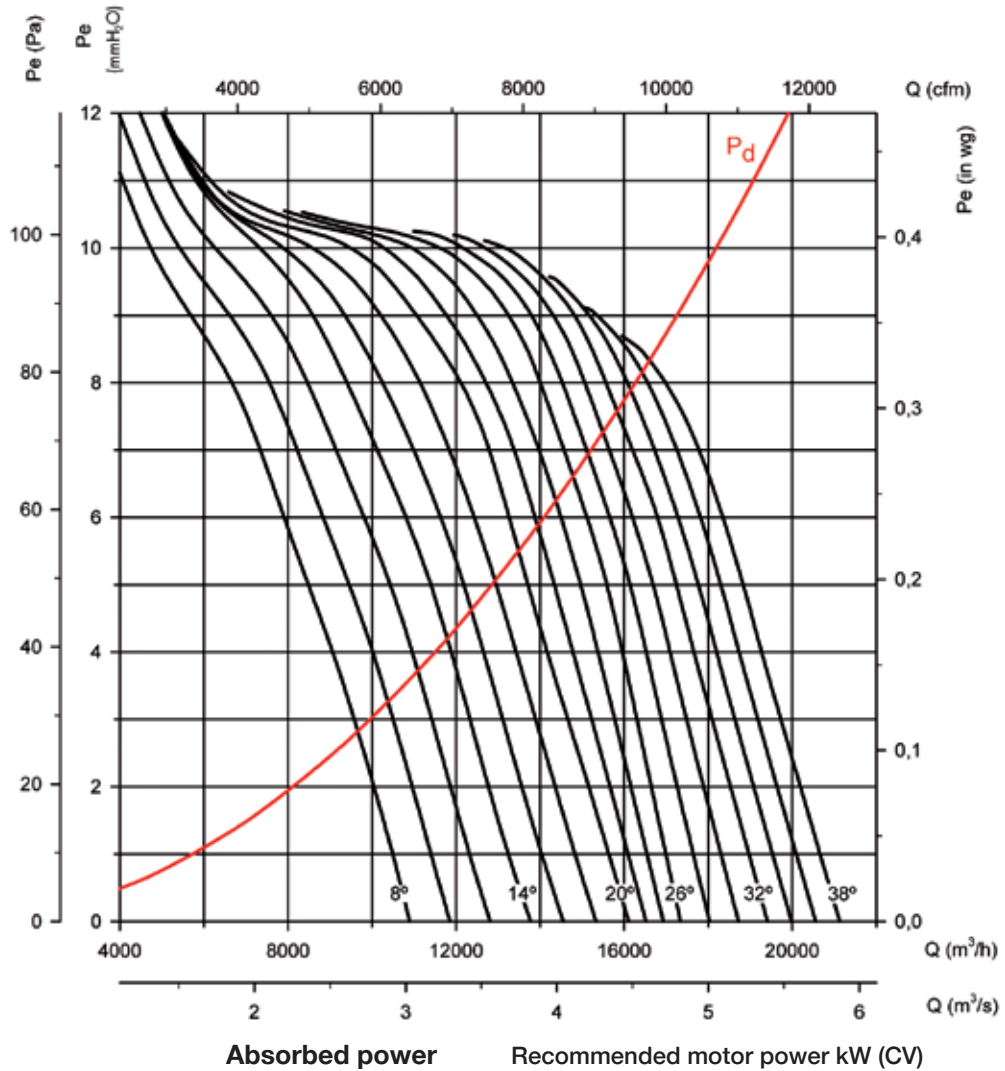

Available features best efficiency point (BEP) at the end of the series.

THT CJTHT/PLUS CJTHT CJTHT/DUPLEX/ATEX

Characteristic curves

THT

CJTHT/PLUS

CJTHT

CJTHT/DUPLEX/ATEX

Q = Airflow in m³/h, m³/s and cfm.

Pe = Static pressure in mm.w.c., Pa and inwg.

Impeller diameter (cm): 80

Number of poles: 4

Number of blades: 6

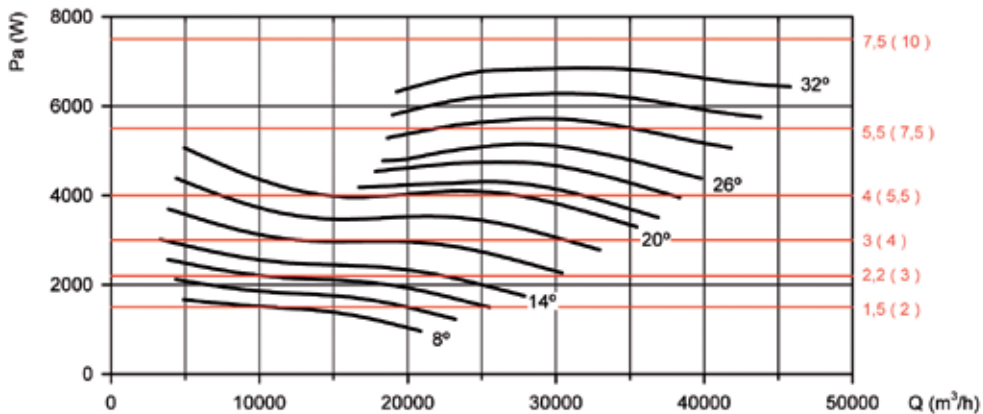
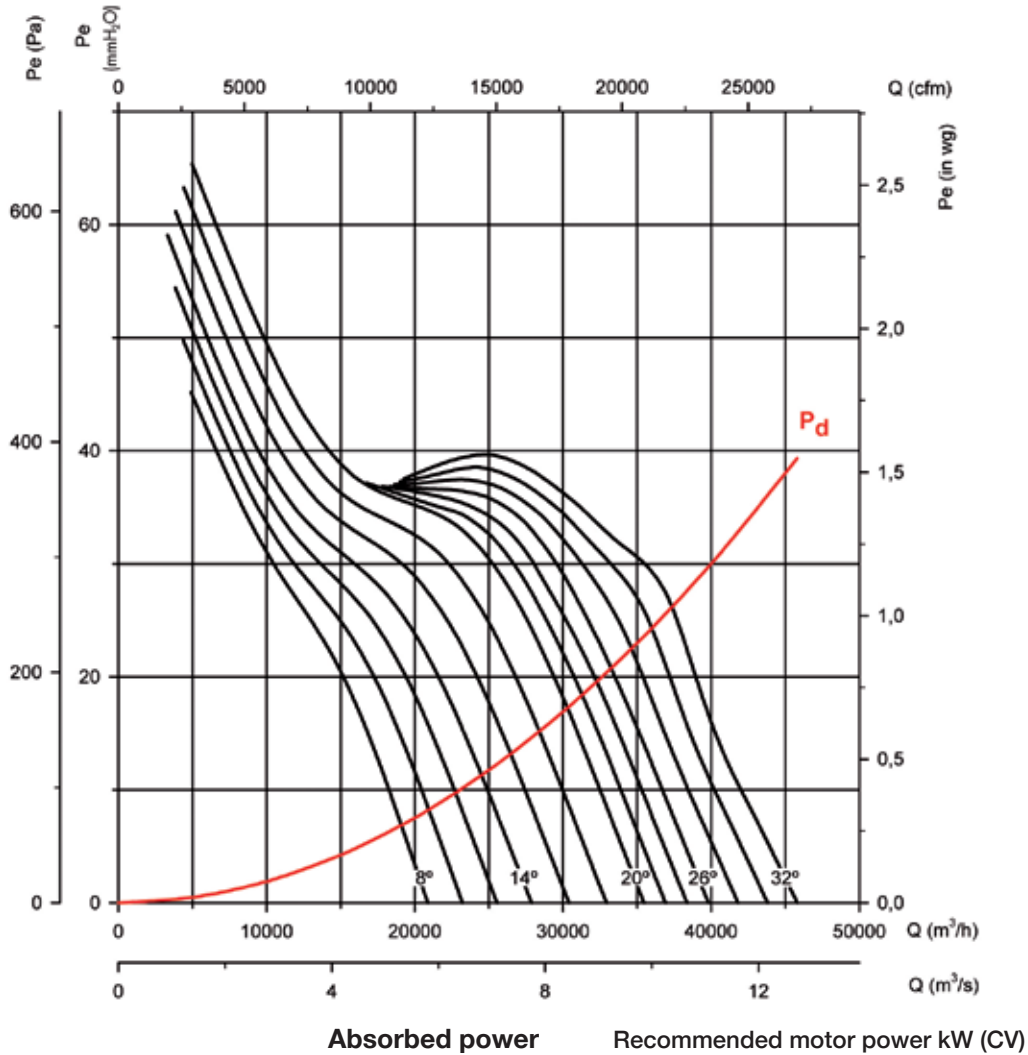

Available features best efficiency point (BEP) at the end of the series.

Characteristic curves

THT CJTHT/PLUS CJTHT CJTHT/DUPLEX/ATEX

Q = Airflow in m³/h, m³/s and cfm.

Pe = Static pressure in mm.w.c., Pa and inwg.

Impeller diameter (cm): 80

Number of poles: 6

Number of blades: 6

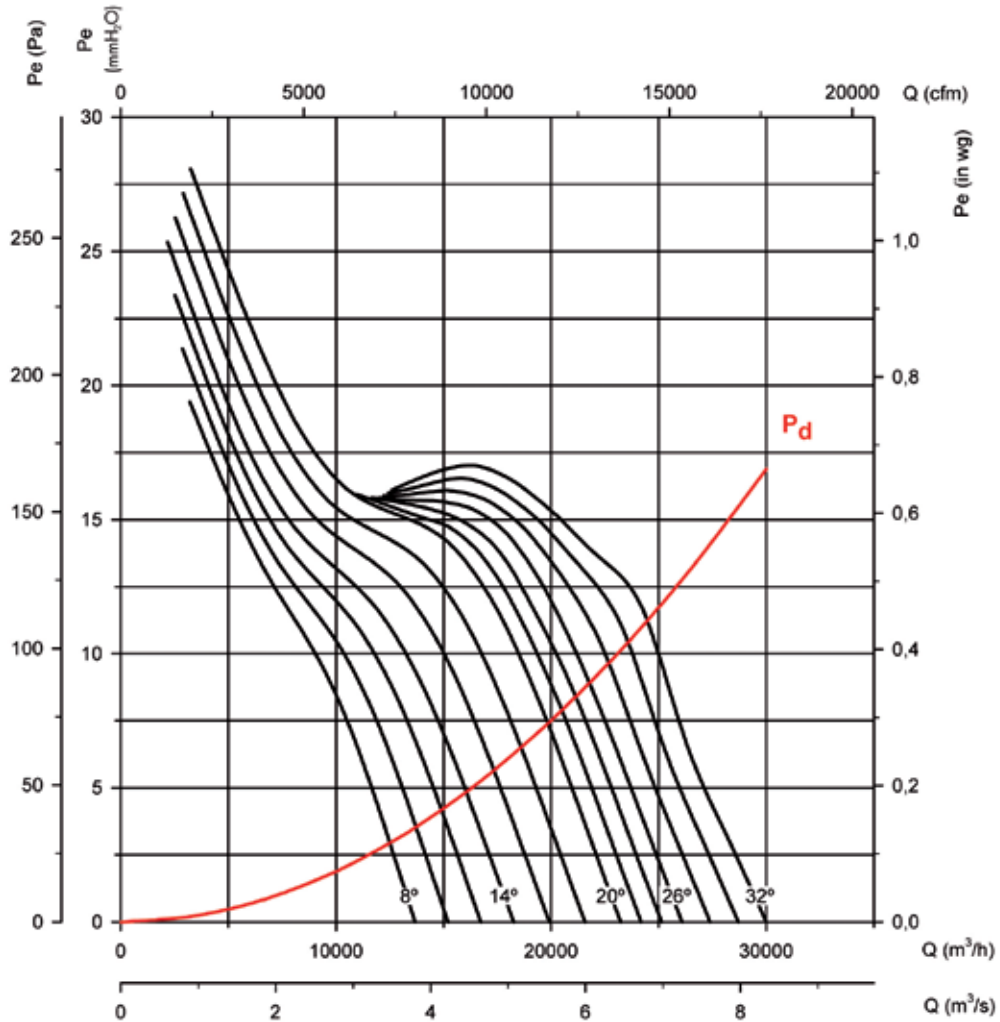

Absorbed power

Recommended motor power kW (CV)

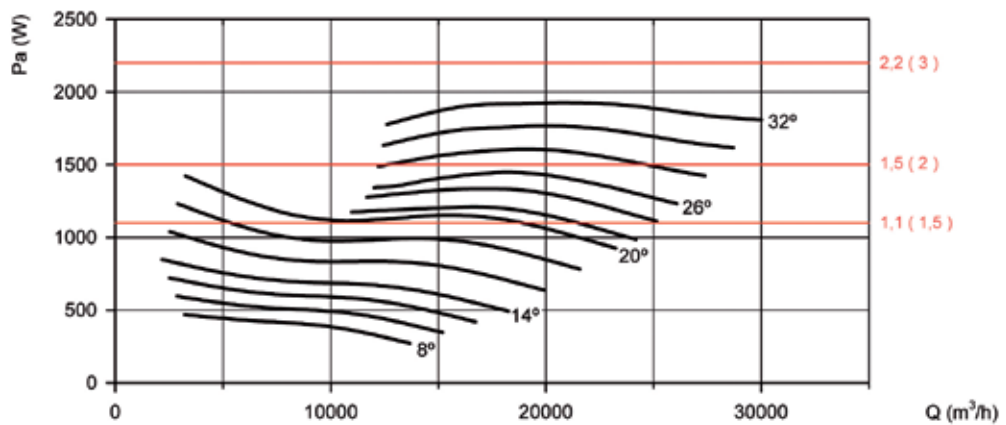

Available features best efficiency point (BEP) at the end of the series.

THT CJTHT/PLUS CJTHT CJTHT/DUPLEX/ATEX

Characteristic curves

THT CJTHT/PLUS CJTHT CJTHT/DUPLEX/ATEX

Q = Airflow in m³/h, m³/s and cfm.

Pe = Static pressure in mm.w.c., Pa and inwg.

Impeller diameter (cm): 80

Number of poles: 8

Number of blades: 6

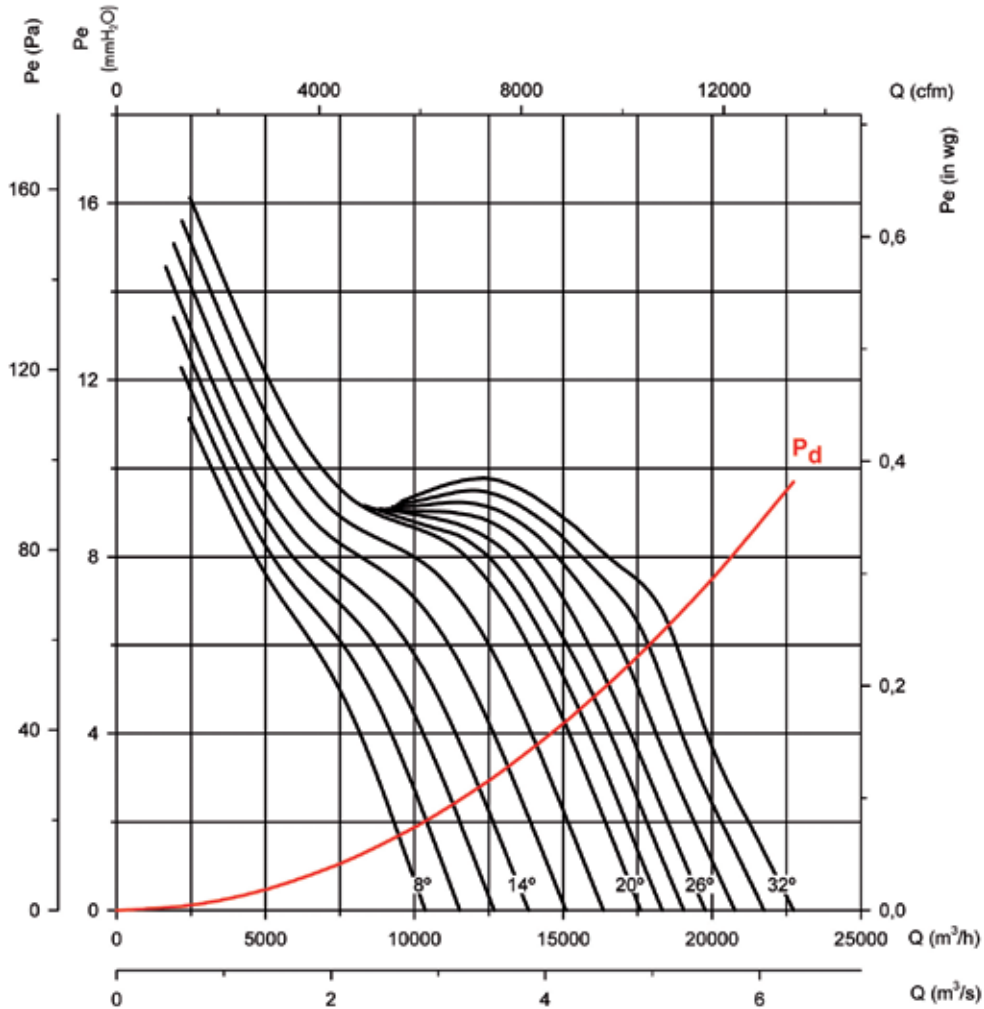

Absorbed power

Recommended motor power kW (CV)

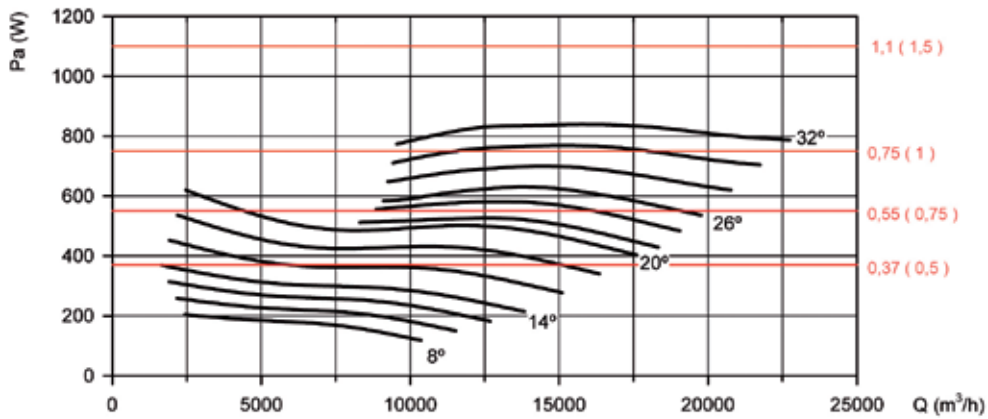

Available features best efficiency point (BEP) at the end of the series.

Characteristic curves

THT

CJTHT/PLUS

CJTHT

CJTHT/DUPLEX/ATEX

Q = Airflow in m³/h, m³/s and cfm.

Pe = Static pressure in mm.w.c., Pa and inwg.

Impeller diameter (cm): 90

Number of poles: 4

Number of blades: 6

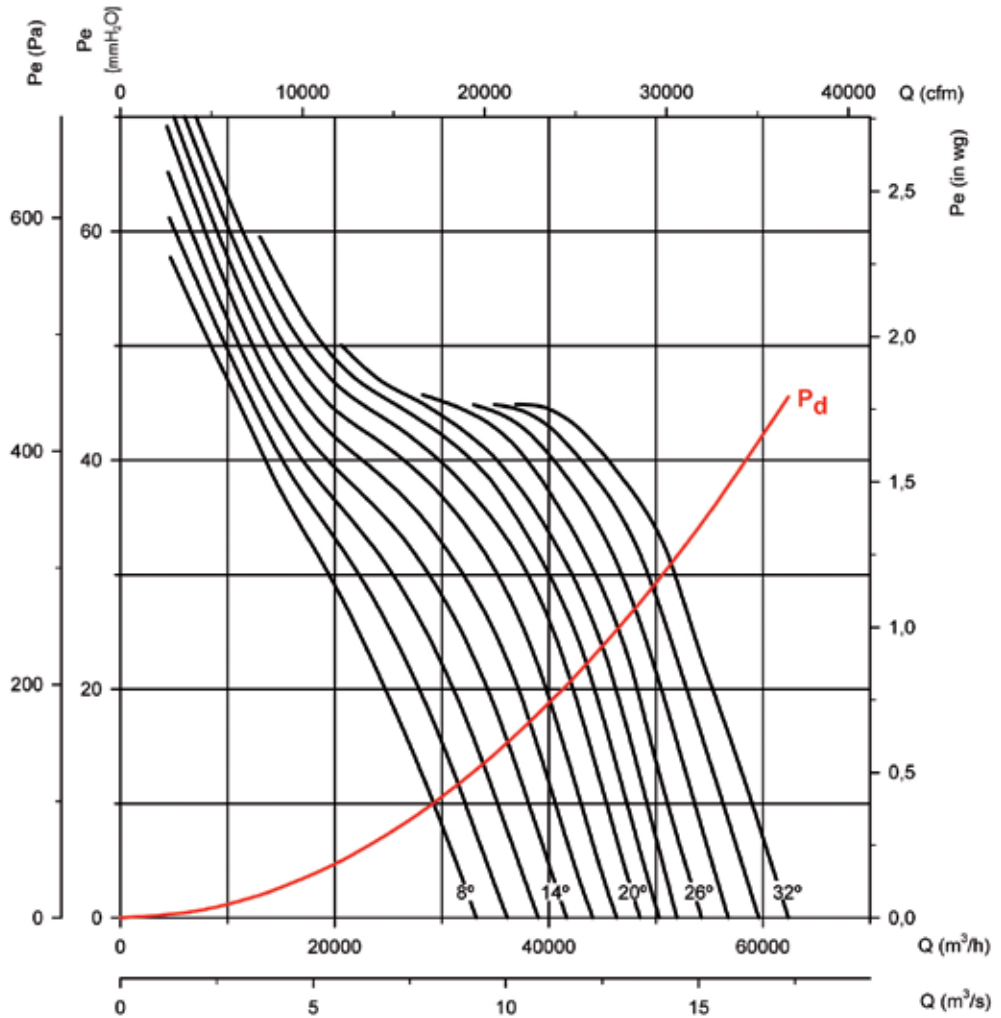

Absorbed power

Recommended motor power kW (CV)

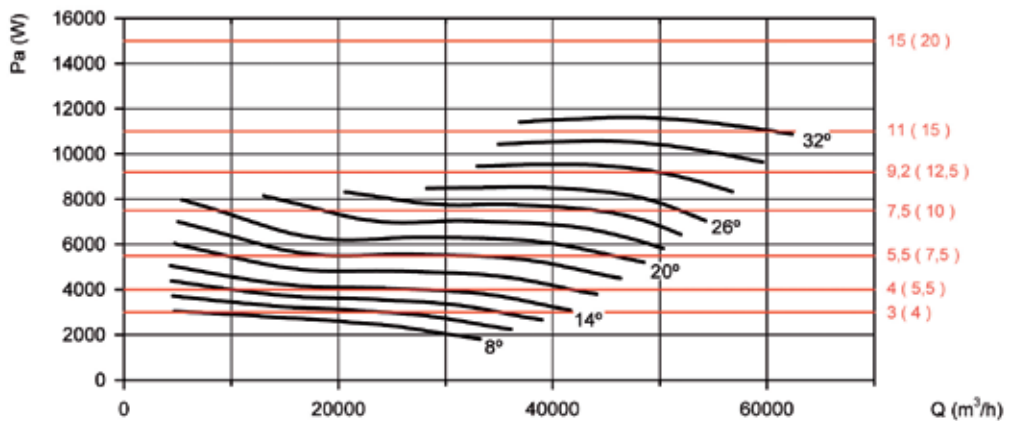

Available features best efficiency point (BEP) at the end of the series.

THT CJTHT/PLUS CJTHT CJTHT/DUPLEX/ATEX

Characteristic curves

THT

CJTHT/PLUS

CJTHT

CJTHT/DUPLEX/ATEX

Q = Airflow in m³/h, m³/s and cfm.

Pe = Static pressure in mm.w.c., Pa and inwg.

Impeller diameter (cm): 90

Number of poles: 6

Number of blades: 6

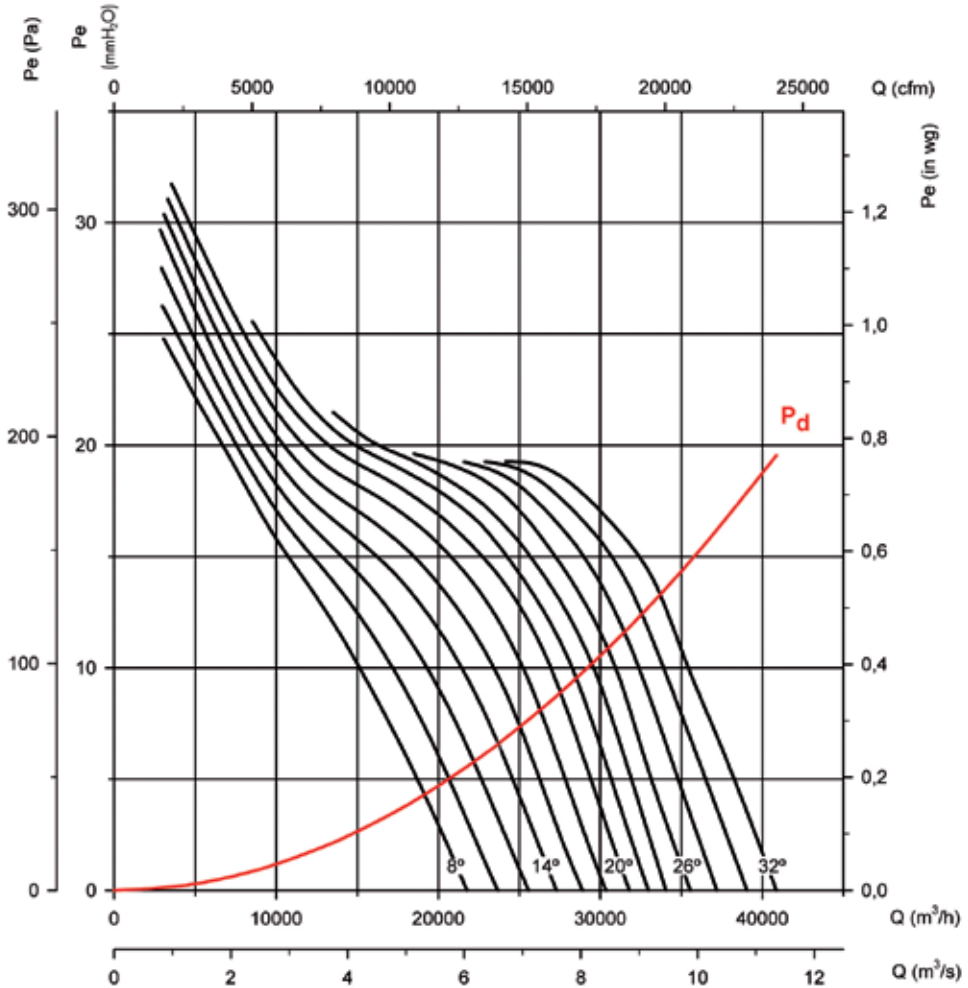

Absorbed power

Recommended motor power kW (CV)

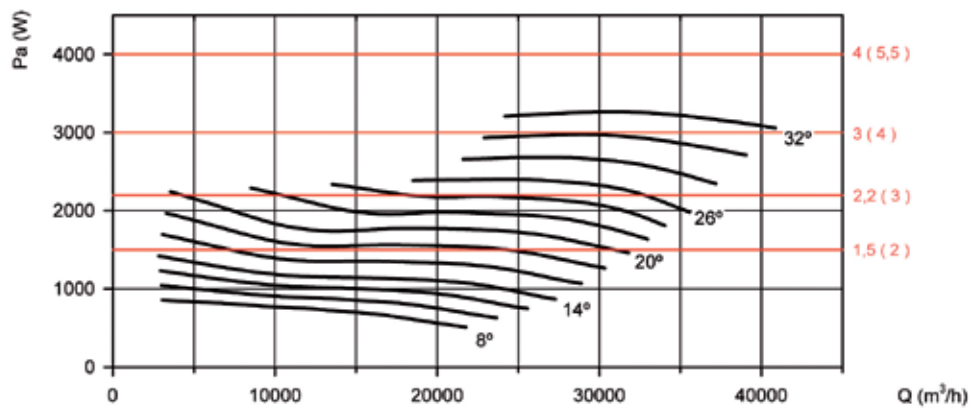

Available features best efficiency point (BEP) at the end of the series.

Characteristic curves

THT CJTHT/PLUS CJTHT CJTHT/DUPLEX/ATEX

Q = Airflow in m³/h, m³/s and cfm.

Pe = Static pressure in mm.w.c., Pa and inwg.

Impeller diameter (cm): 90

Number of poles: 8

Number of blades: 6

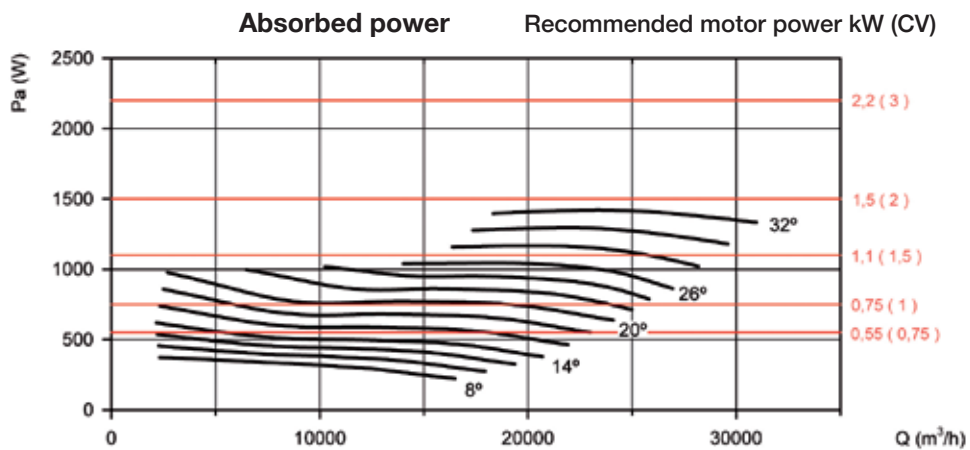
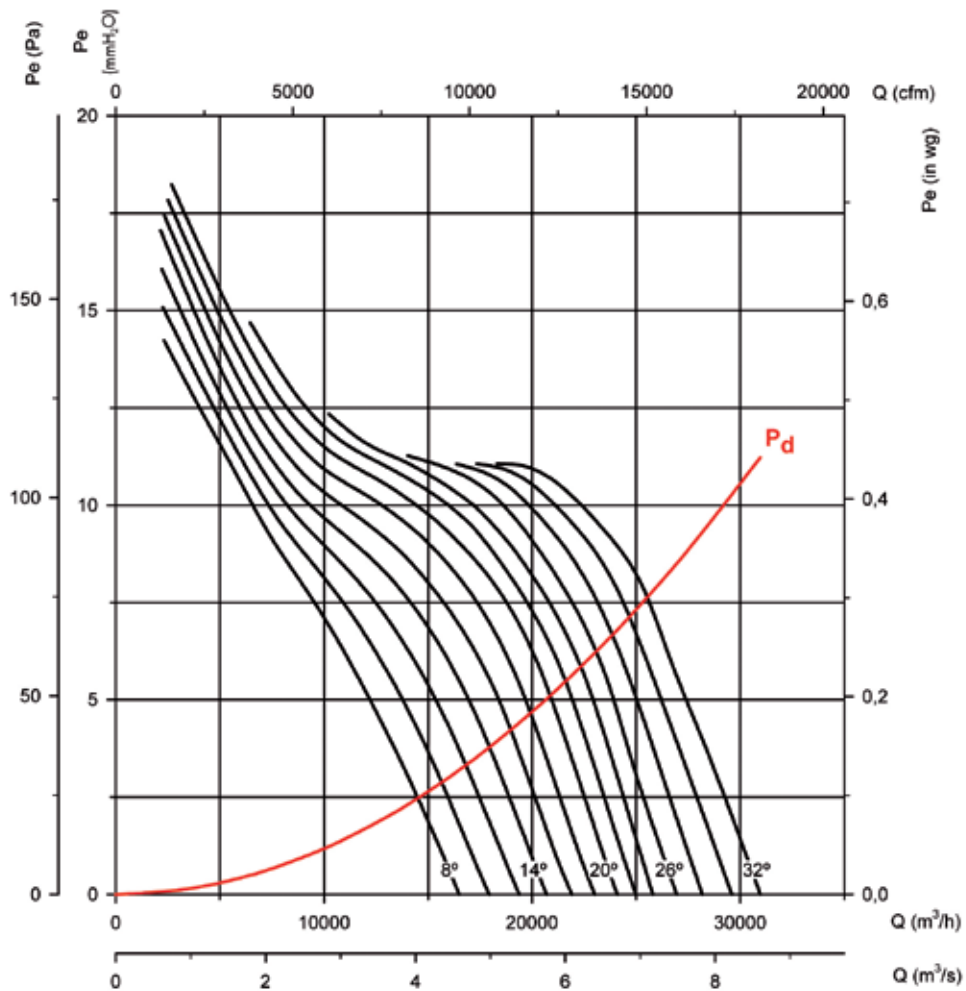

Available features best efficiency point (BEP) at the end of the series.

THT CJTHT/PLUS CJTHT CJTHT/DUPLEX/ATEX

Characteristic curves

THT

CJTHT/PLUS

CJTHT

CJTHT/DUPLEX/ATEX

Q = Airflow in m³/h, m³/s and cfm.

Pe = Static pressure in mm.w.c., Pa and inwg.

Impeller diameter (cm): 100

Number of poles: 4

Number of blades: 6

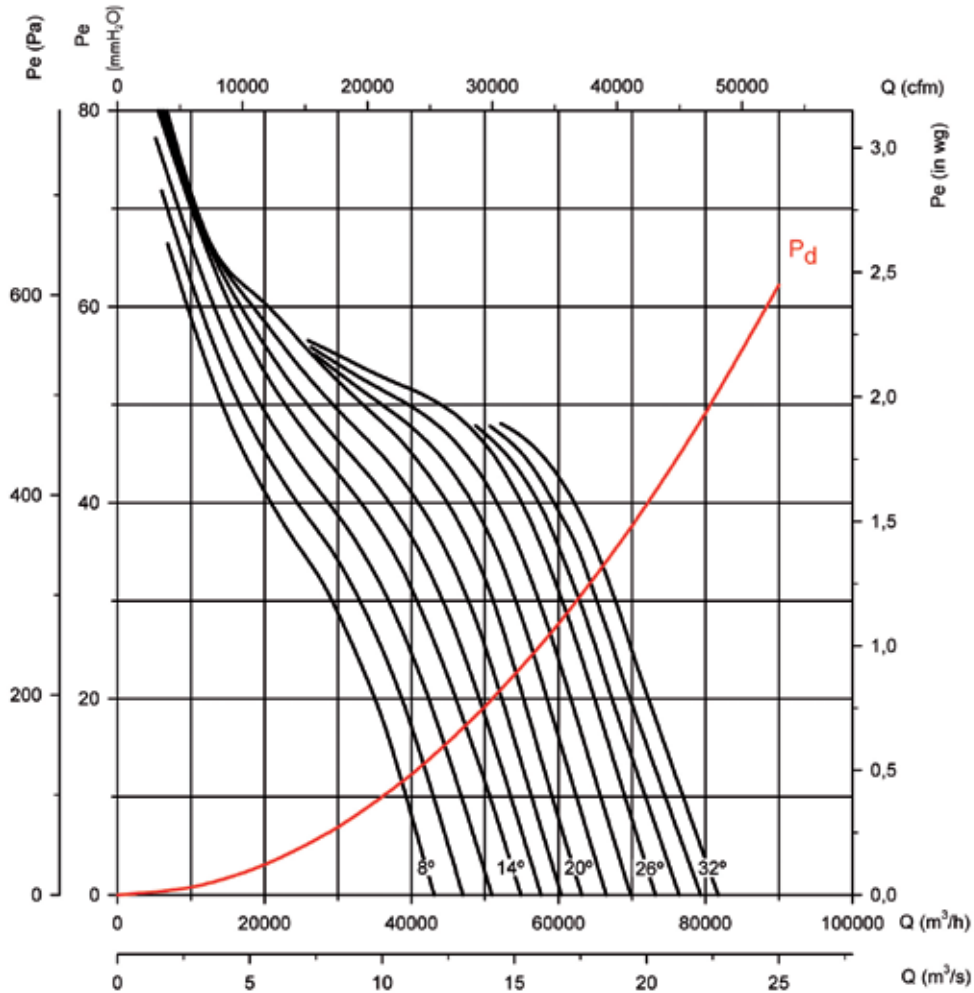

Absorbed power

Recommended motor power kW (CV)

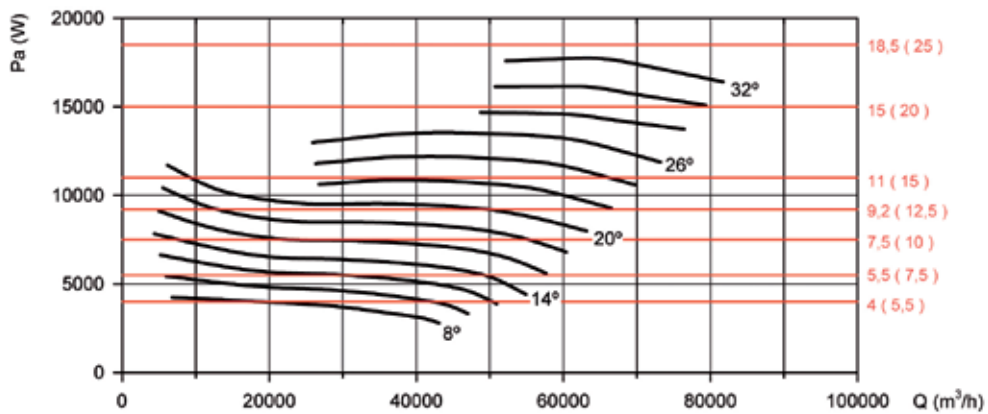

Available features best efficiency point (BEP) at the end of the series.

Characteristic curves

THT CJTHT/PLUS CJTHT CJTHT/DUPLEX/ATEX

Q = Airflow in m³/h, m³/s and cfm.

Pe = Static pressure in mm.w.c., Pa and inwg.

Impeller diameter (cm): 100 Number of poles: 6 Number of blades: 6

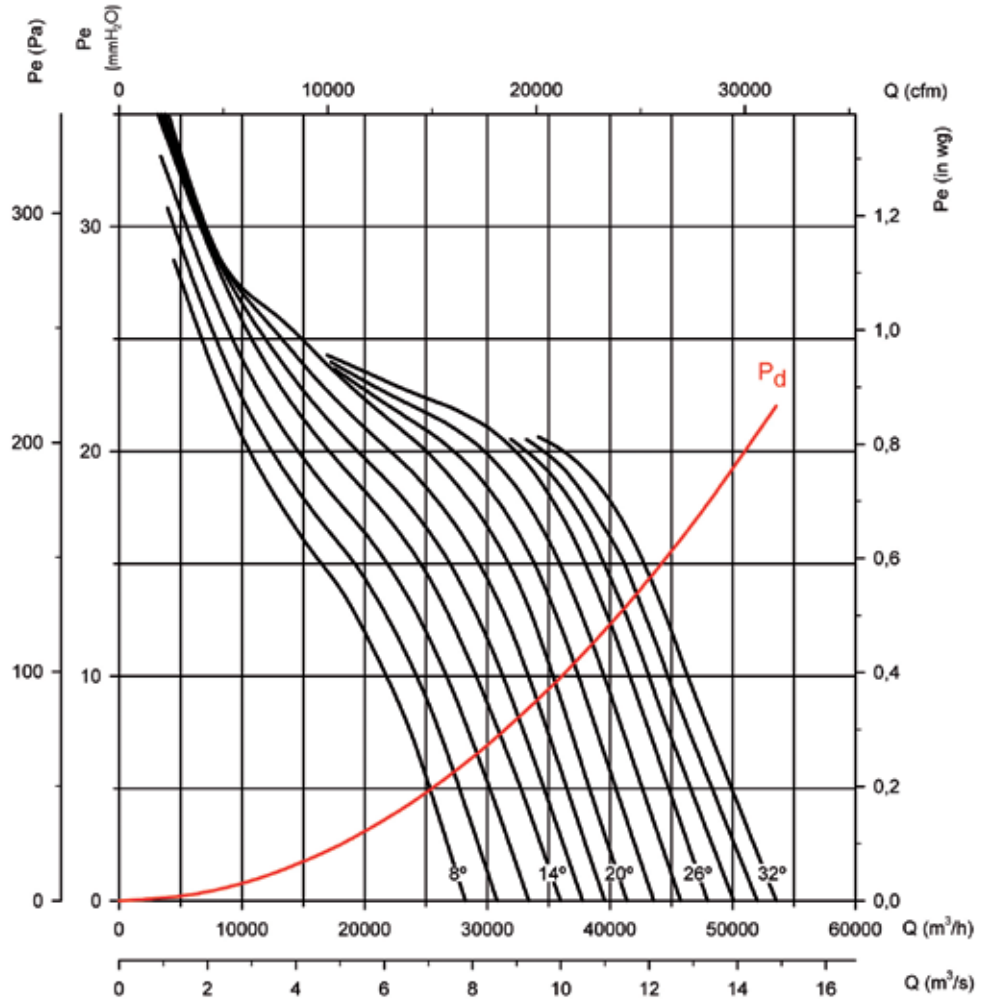

Absorbed power Recommended motor power kW (CV)

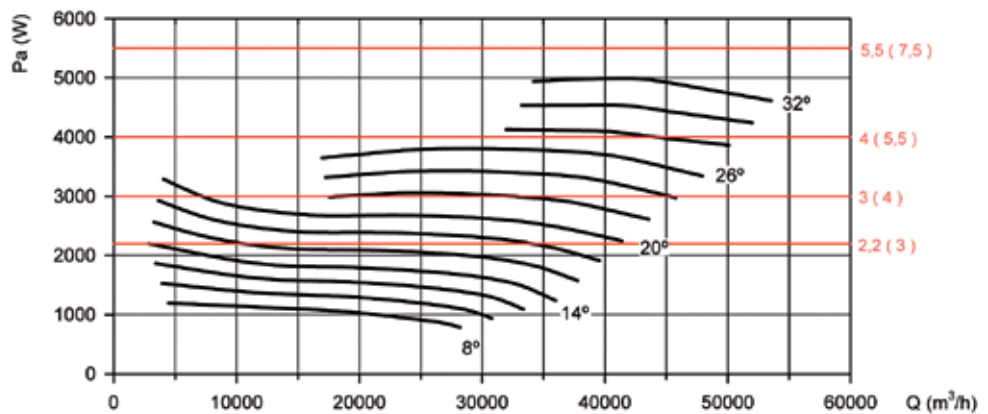

Available features best efficiency point (BEP) at the end of the series.

THT CJTHT/PLUS CJTHT CJTHT/DUPLEX/ATEX

Characteristic curves

THT

CJTHT/PLUS

CJTHT

CJTHT/DUPLEX/ATEX

Q = Airflow in m³/h, m³/s and cfm.

Pe = Static pressure in mm.w.c., Pa and inwg.

Impeller diameter (cm): 100

Number of poles: 8

Number of blades: 6

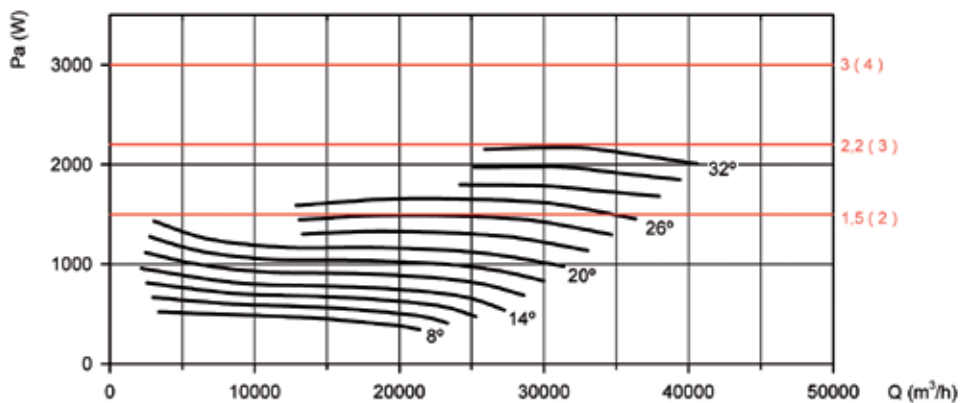
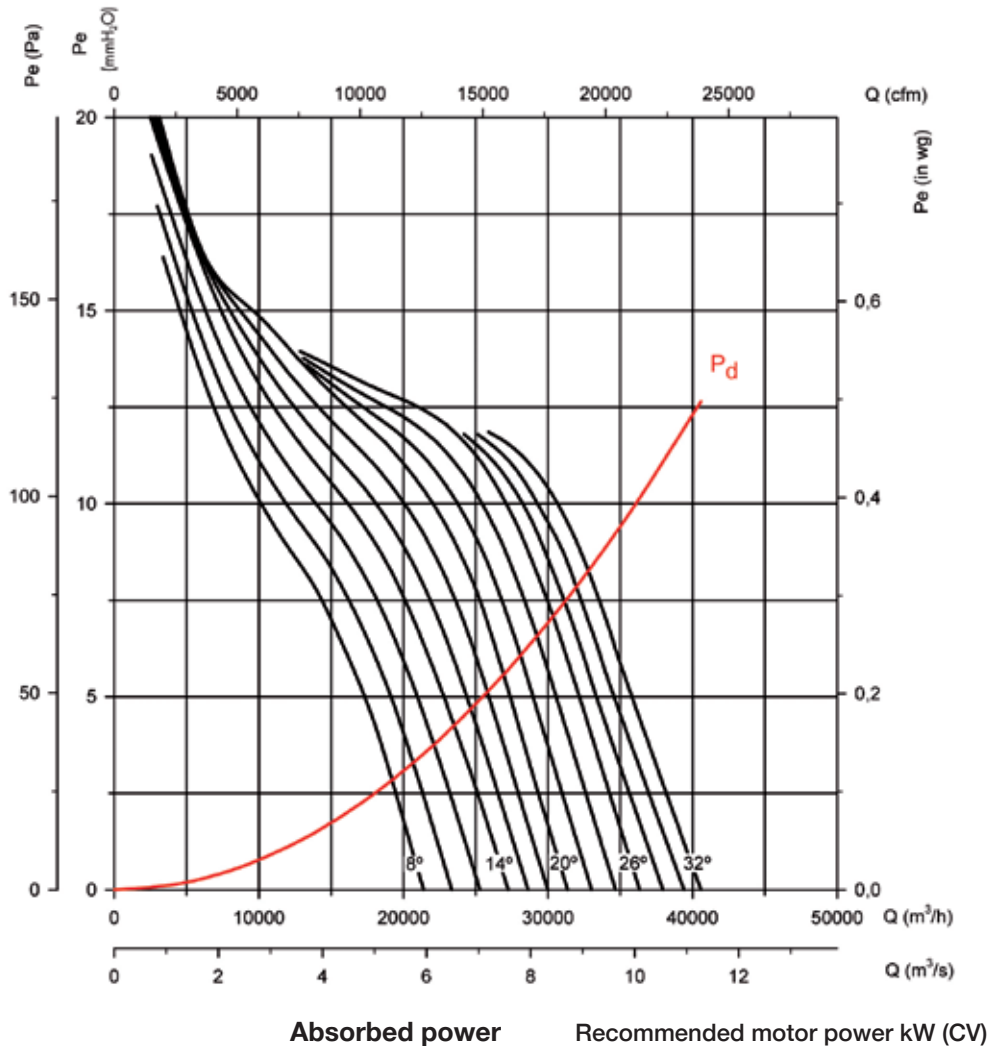

Available features best efficiency point (BEP) at the end of the series.

Characteristic curves

THT CJTHT/PLUS CJTHT CJTHT/DUPLEX/ATEX

Q = Airflow in m³/h, m³/s and cfm.

Pe = Static pressure in mm.w.c., Pa and inwg.

Impeller diameter (cm): 125 Number of poles: 4 Number of blades: 3

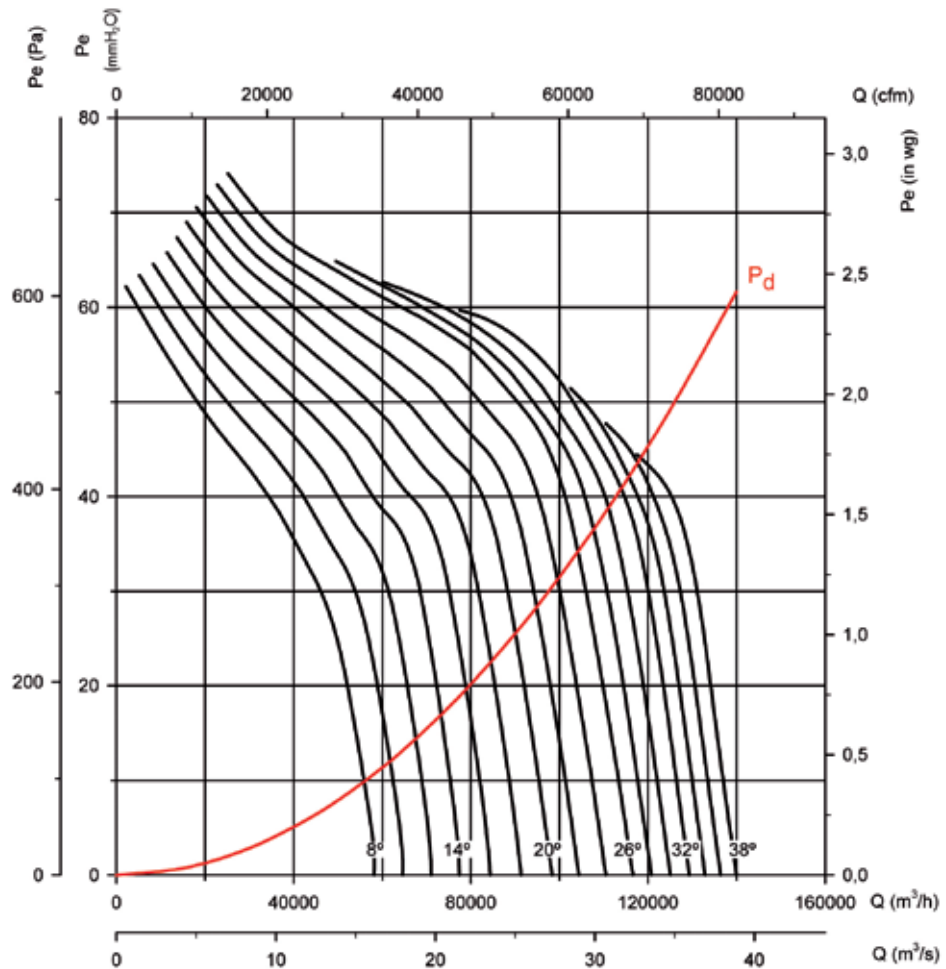

Absorbed power Recommended motor power kW (CV)

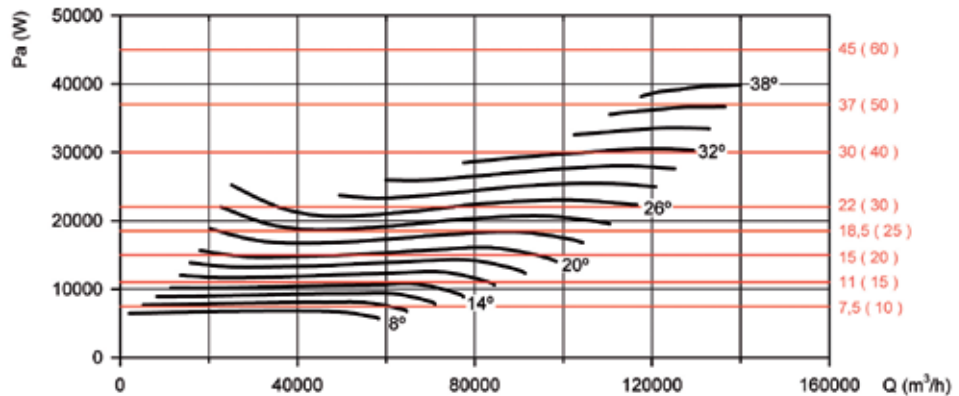

Available features best efficiency point (BEP) at the end of the series.

THT CJTHT/PLUS CJTHT CJTHT/DUPLEX/ATEX

Characteristic curves

THT

CJTHT/PLUS

CJTHT

CJTHT/DUPLEX/ATEX

Q = Airflow in m³/h, m³/s and cfm.

Pe = Static pressure in mm.w.c., Pa and inwg.

Impeller diameter (cm): 125

Number of poles: 4

Number of blades: 6

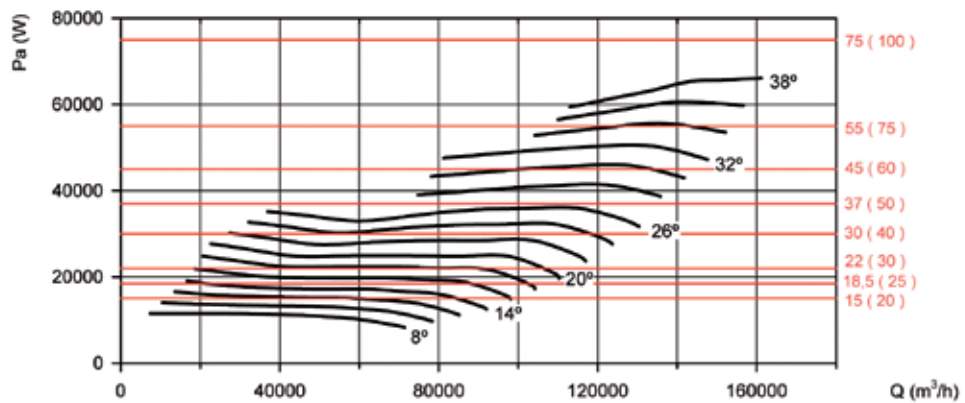
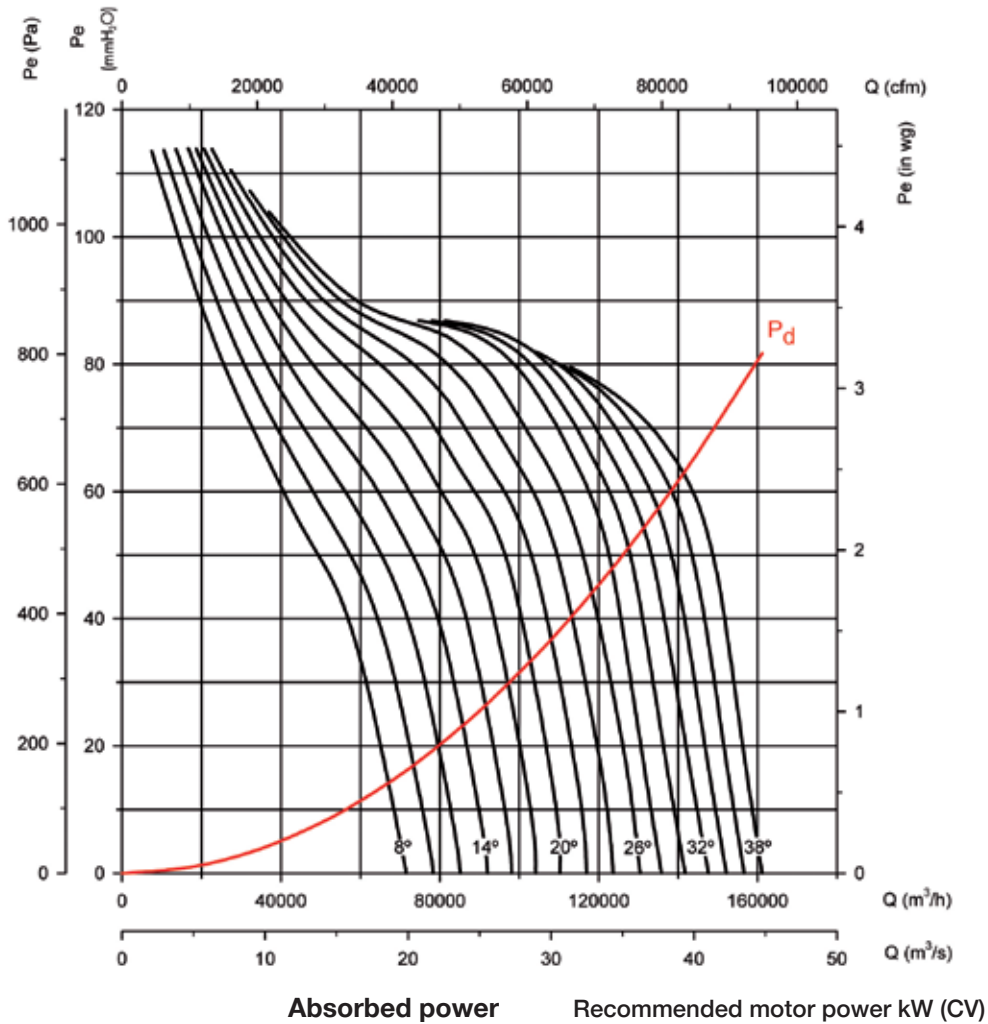

Available features best efficiency point (BEP) at the end of the series.

Characteristic curves

THT CJTHT/PLUS CJTHT CJTHT/DUPLEX/ATEX

Q = Airflow in m³/h, m³/s and cfm.

Pe = Static pressure in mm.w.c., Pa and inwg.

Impeller diameter (cm): 125 Number of poles: 4 Number of blades: 9

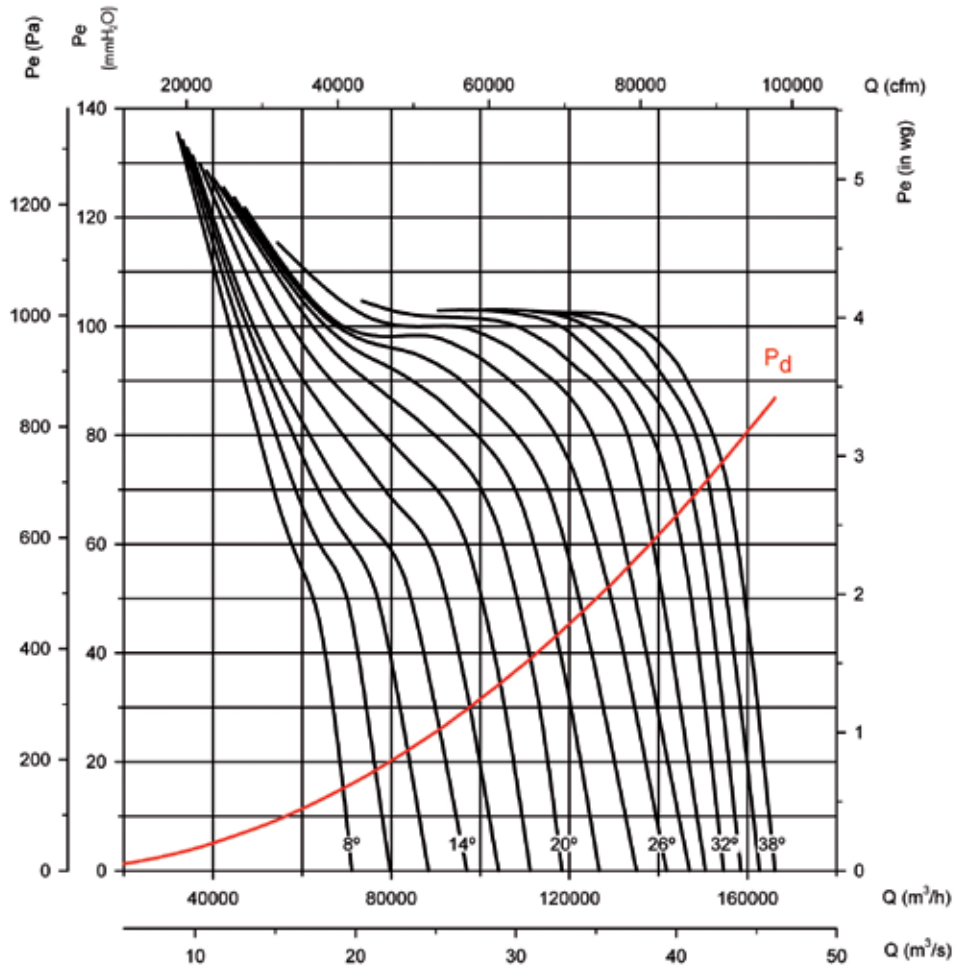

Absorbed power

Recommended motor power kW (CV)

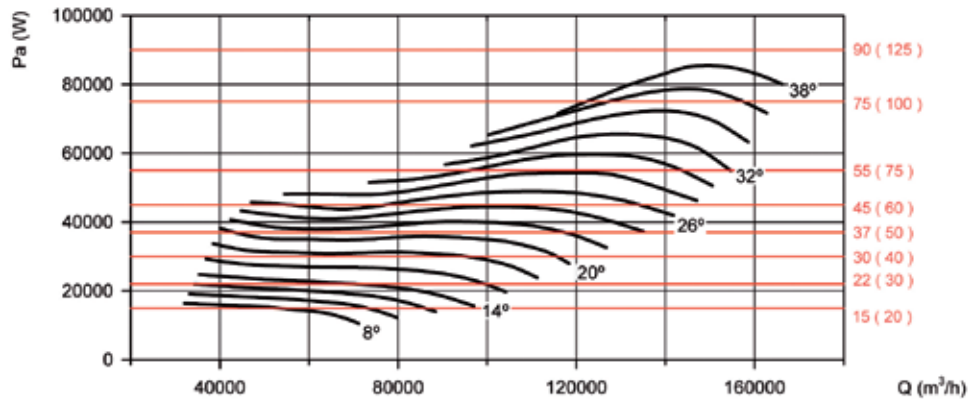

Available features best efficiency point (BEP) at the end of the series.

THT CJTHT/PLUS CJTHT CJTHT/DUPLEX/ATEX

Characteristic curves

THT

CJTHT/PLUS

CJTHT

CJTHT/DUPLEX/ATEX

Q = Airflow in m³/h, m³/s and cfm.

Pe = Static pressure in mm.w.c., Pa and inwg.

Impeller diameter (cm): 125

Number of poles: 6

Number of blades: 3

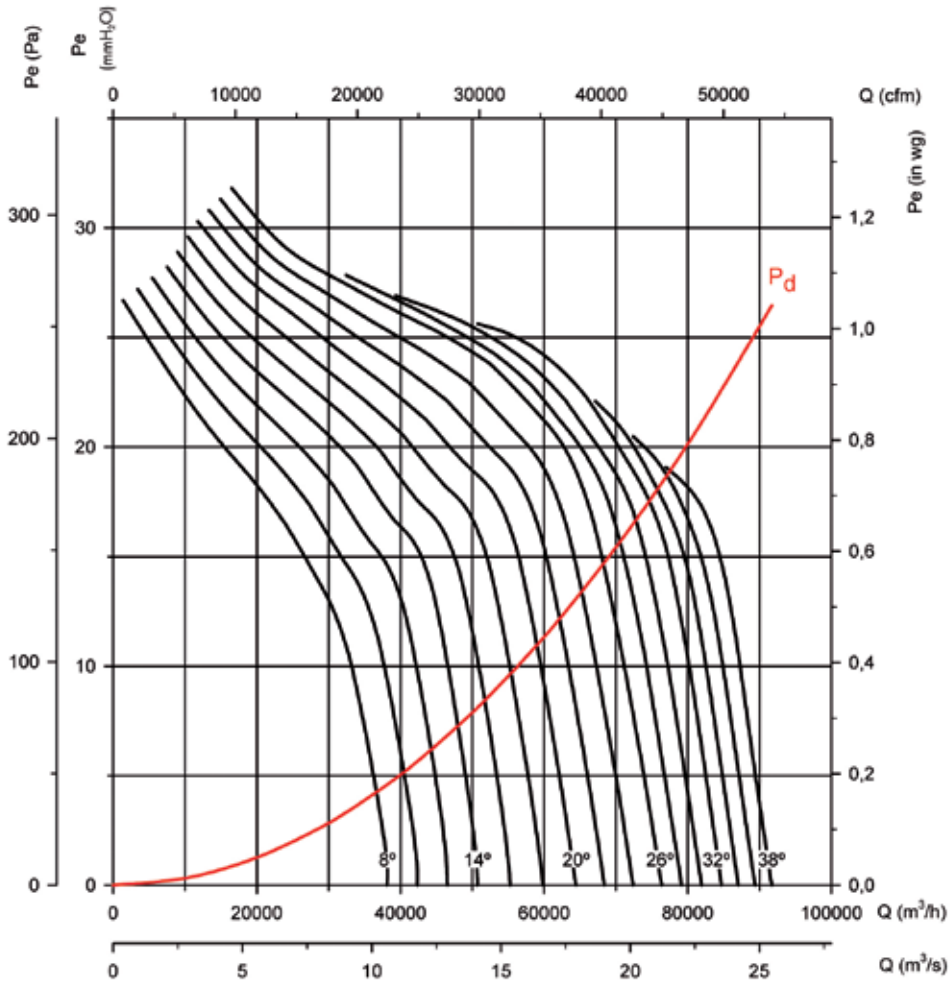

Absorbed power

Recommended motor power kW (CV)

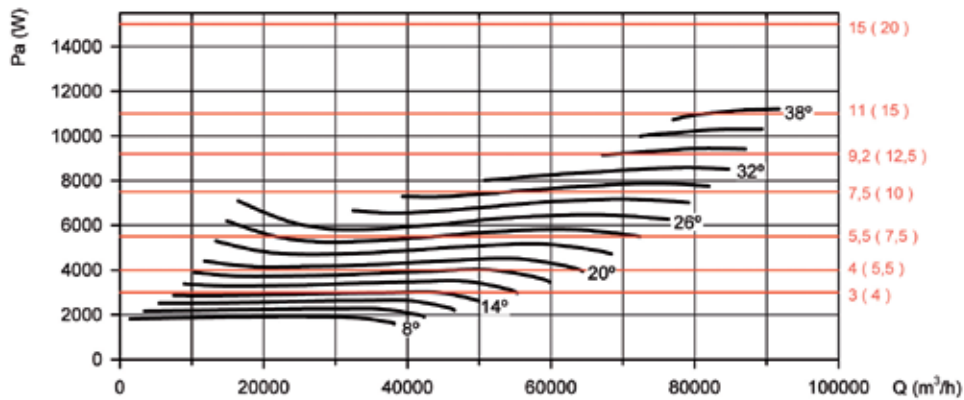

Available features best efficiency point (BEP) at the end of the series.

Characteristic curves

THT CJTHT/PLUS CJTHT CJTHT/DUPLEX/ATEX

Q = Airflow in m³/h, m³/s and cfm.

Pe= Static pressure in mm.w.c., Pa and inwg.

Impeller diameter (cm): 125 Number of poles: 6 Number of blades: 6

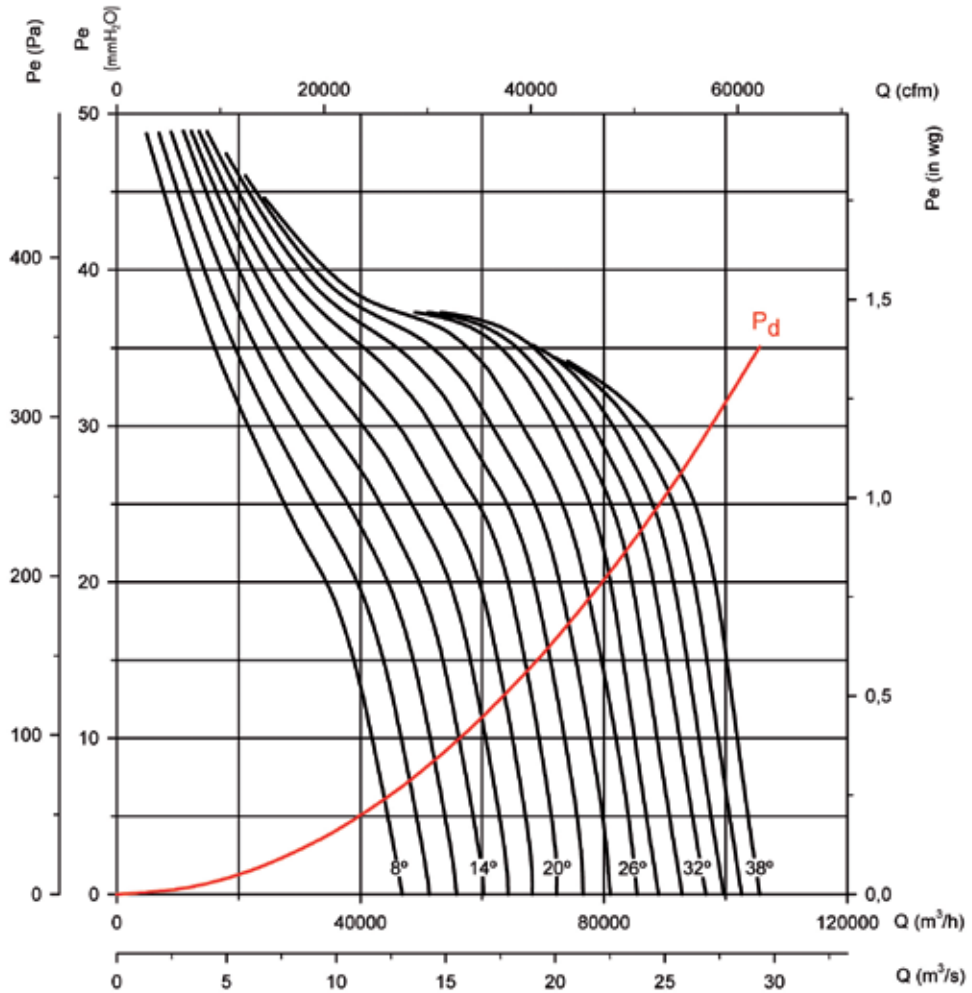

Absorbed power

Recommended motor power kW (CV)

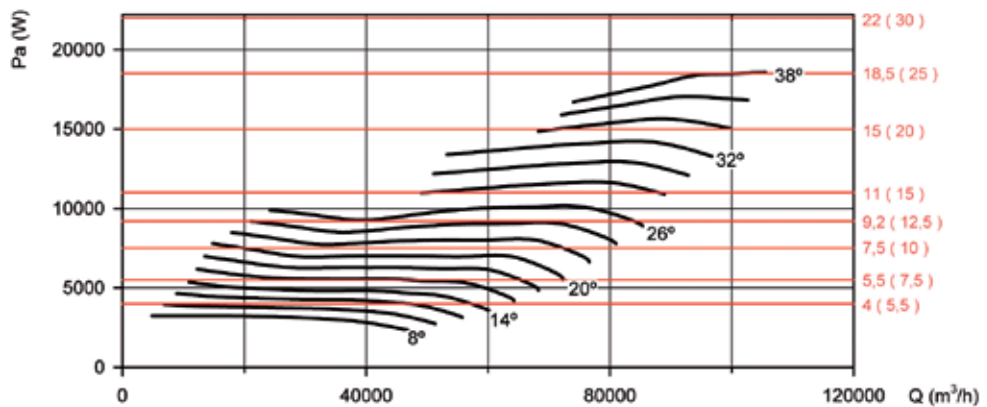

Available features best efficiency point (BEP) at the end of the series.

THT CJTHT/PLUS CJTHT CJTHT/DUPLEX/ATEX

Characteristic curves

THT

CJTHT/PLUS

CJTHT

CJTHT/DUPLEX/ATEX

Q = Airflow in m³/h, m³/s and cfm.

Pe = Static pressure in mm.w.c., Pa and inwg.

Impeller diameter (cm): 125

Number of poles: 6

Number of blades: 9

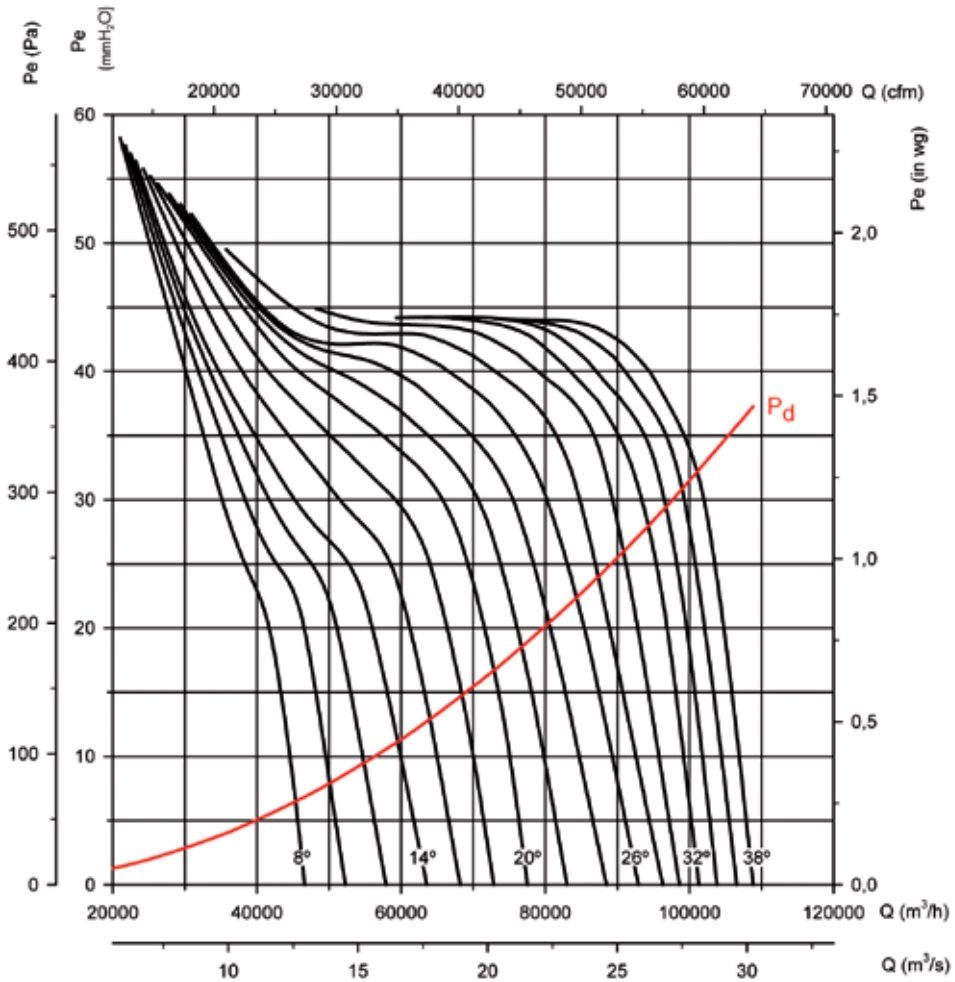

Absorbed power

Recommended motor power kW (CV)

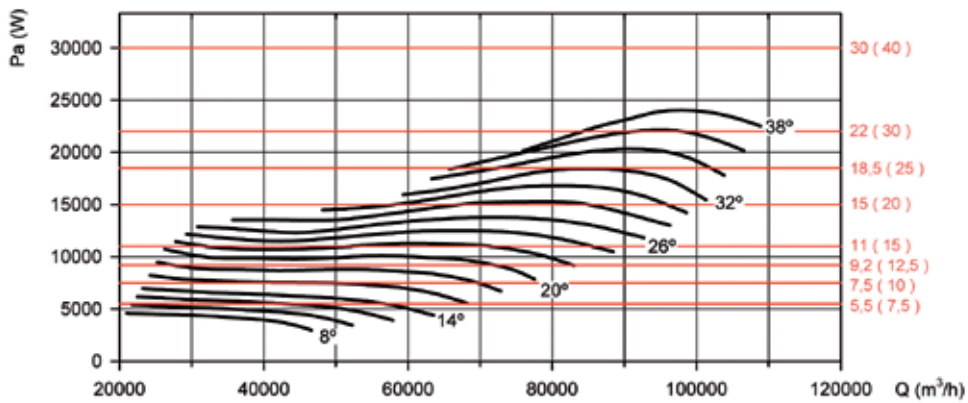

Available features best efficiency point (BEP) at the end of the series.

Characteristic curves

Q = Airflow in m³/h, m³/s and cfm.

Pe = Static pressure in mm.w.c., Pa and inwg.

Impeller diameter (cm): 140 Number of poles: 6 Number of blades: 3

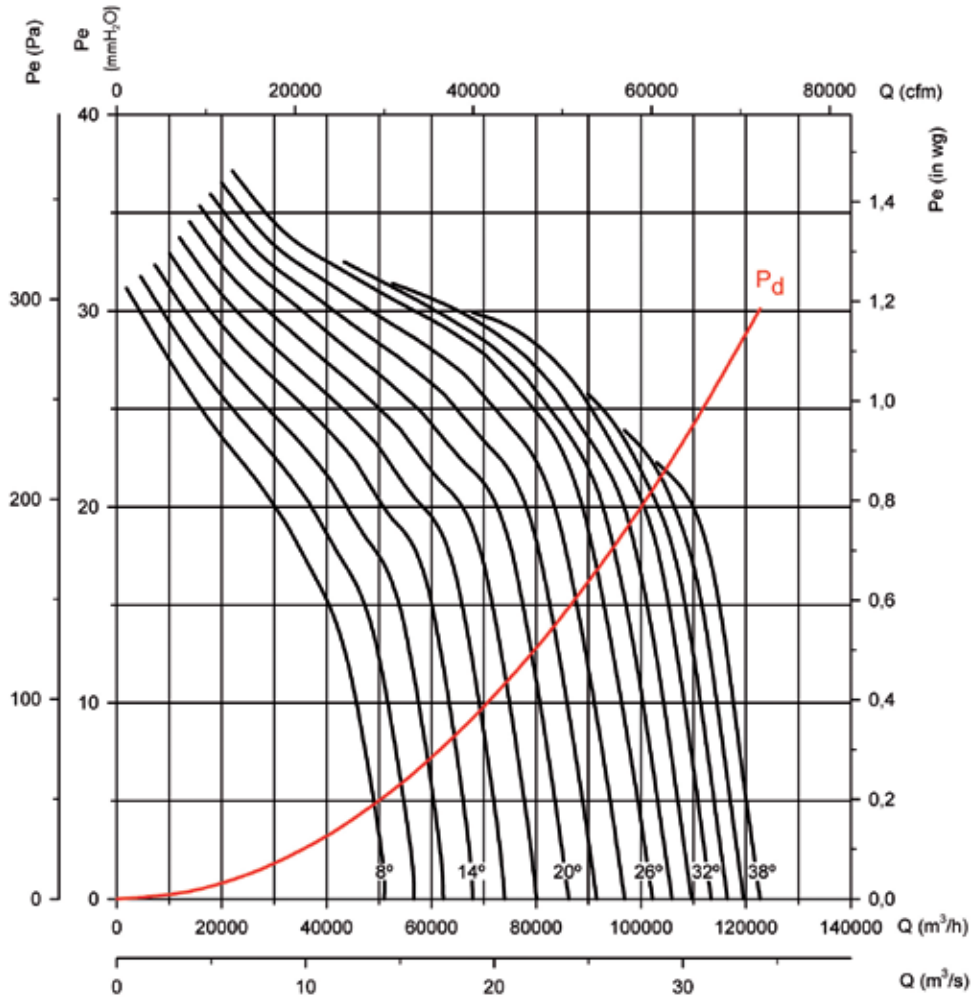

Absorbed power

Recommended motor power kW (CV)

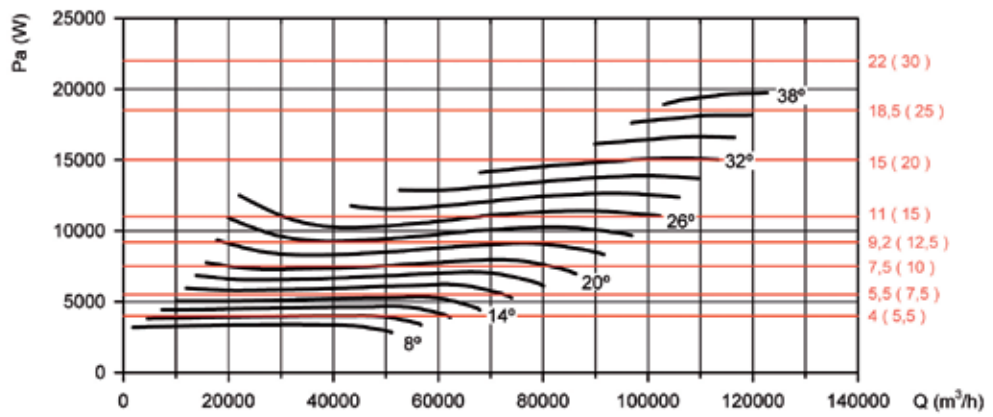

Available features best efficiency point (BEP) at the end of the series.

THT CJTHT/PLUS CJTHT CJTHT/DUPLEX/ATEX

Characteristic curves

THT CJTHT/PLUS CJTHT CJTHT/DUPLEX/ATEX

Q = Airflow in m³/h, m³/s and cfm.

Pe = Static pressure in mm.w.c., Pa and inwg.

Impeller diameter (cm): 140 Number of poles: 6 Number of blades: 6

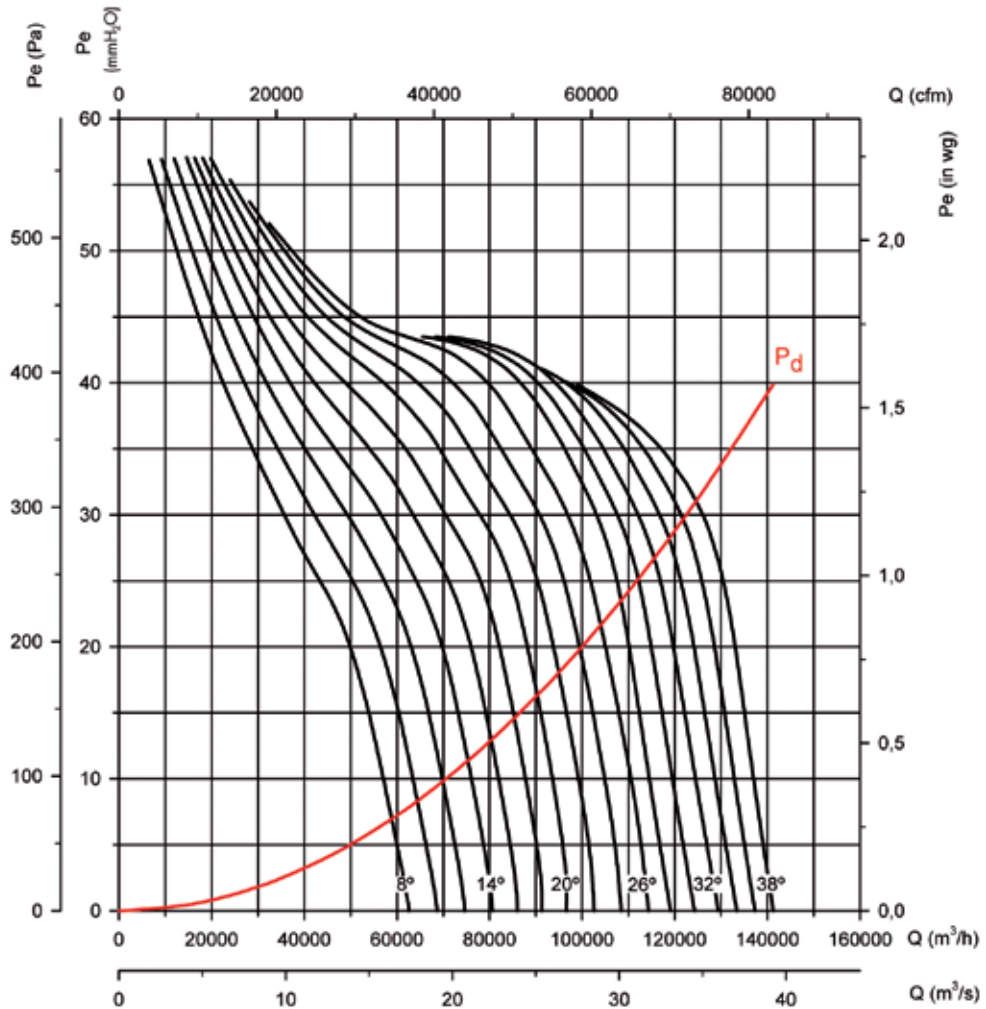

Absorbed power

Recommended motor power kW (CV)

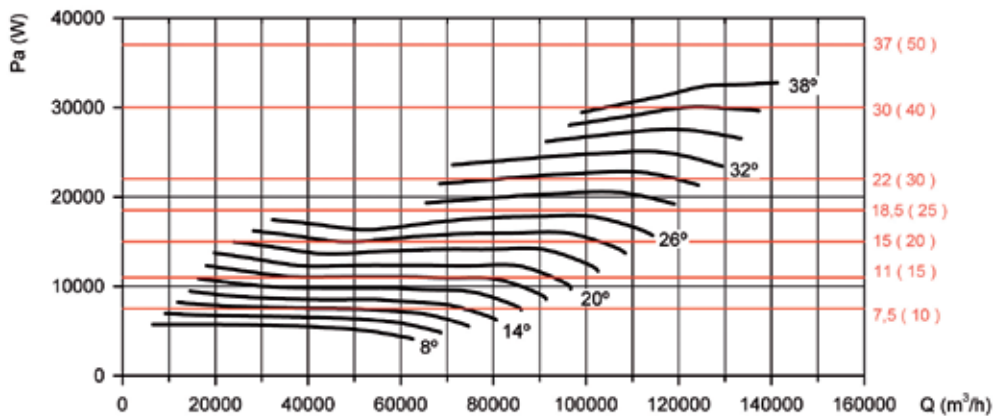

Available features best efficiency point (BEP) at the end of the series.

Characteristic curves

THT CJTHT/PLUS CJTHT CJTHT/DUPLEX/ATEX

Q = Airflow in m³/h, m³/s and cfm.

Pe = Static pressure in mm.w.c., Pa and inwg.

Impeller diameter (cm): 140 Number of poles: 6 Number of blades: 9

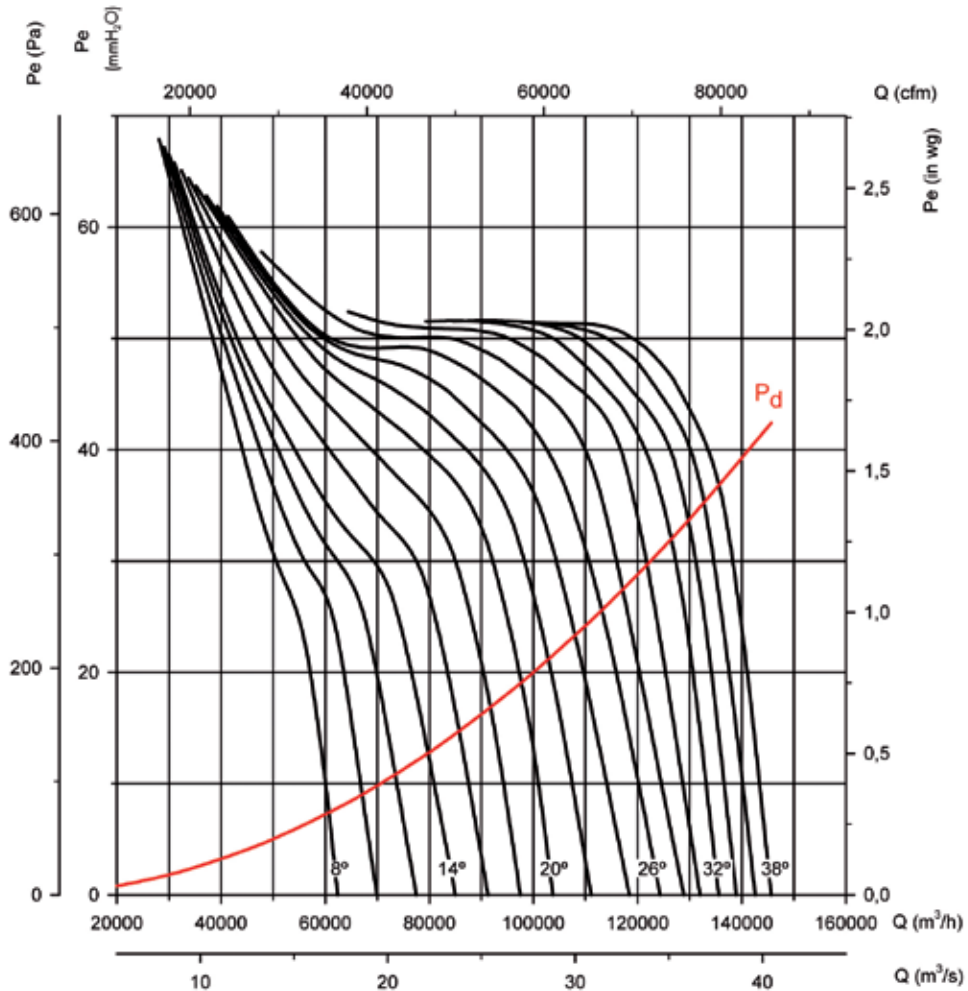

Absorbed power Recommended motor power kW (CV)

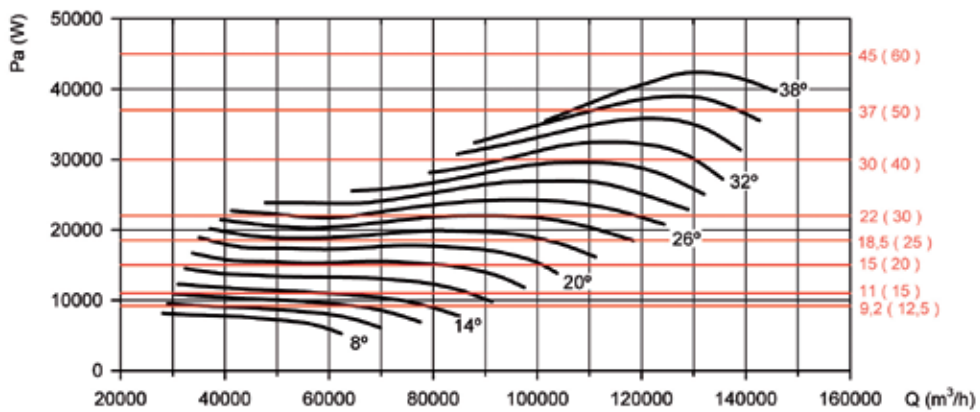

Available features best efficiency point (BEP) at the end of the series.

THT CJTHT/PLUS CJTHT CJTHT/DUPLEX/ATEX

Characteristic curves

THT CJTHT/PLUS CJTHT CJTHT/DUPLEX/ATEX

Q = Airflow in m³/h, m³/s and cfm.

Pe = Static pressure in mm.w.c., Pa and inwg.

Impeller diameter (cm): 140 Number of poles: 8 Number of blades: 3

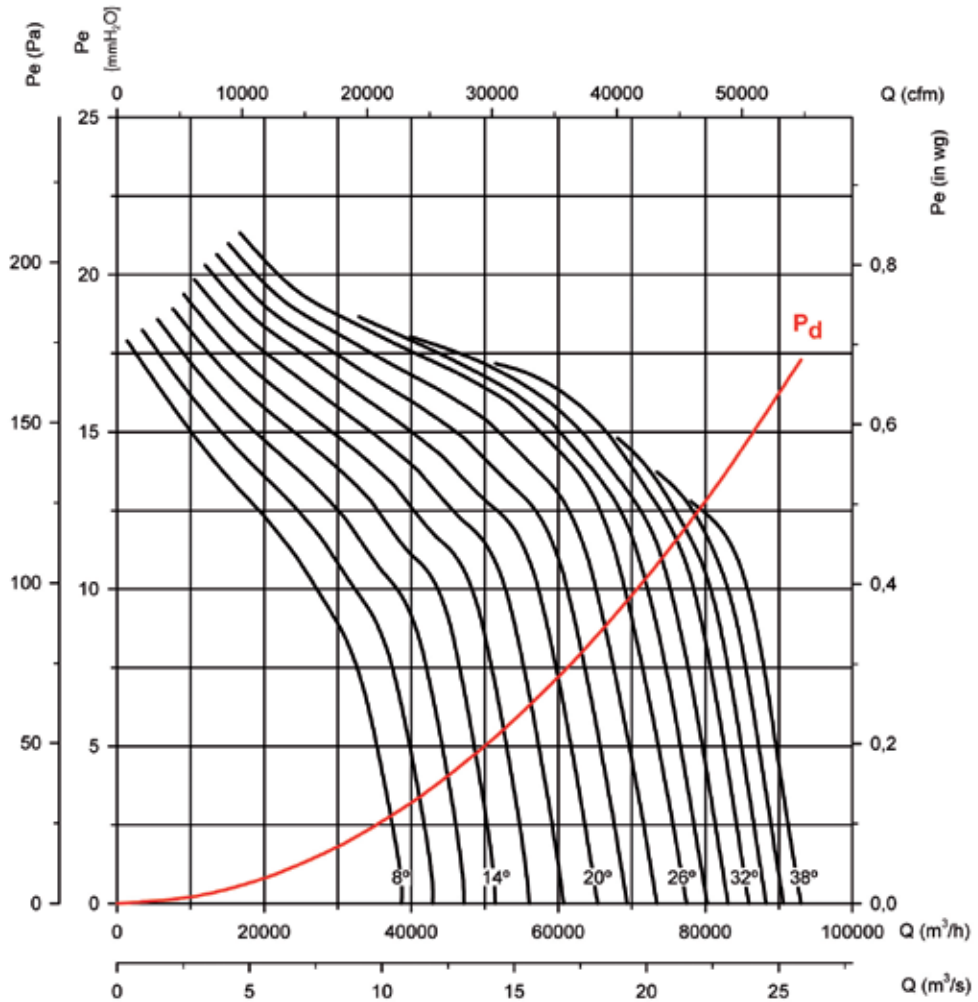

Absorbed power

Recommended motor power kW (CV)

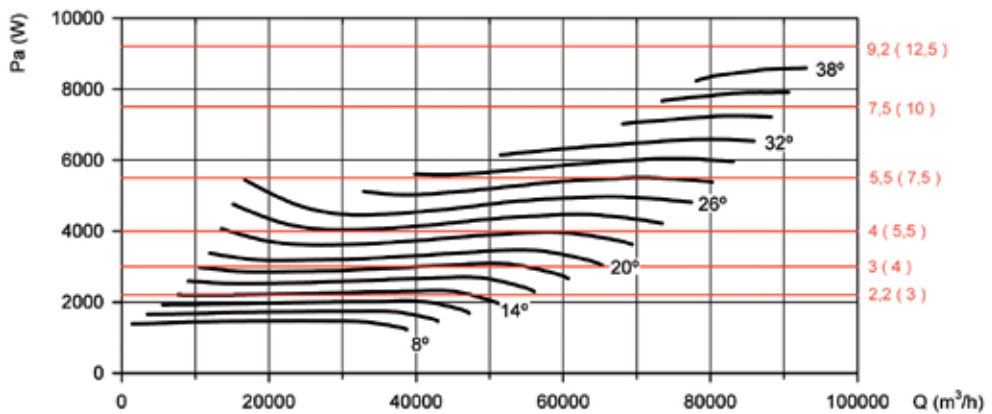

Available features best efficiency point (BEP) at the end of the series.

Characteristic curves

THT CJTHT/PLUS CJTHT CJTHT/DUPLEX/ATEX

Q = Airflow in m³/h, m³/s and cfm.

Pe = Static pressure in mm.w.c., Pa and inwg.

Impeller diameter (cm): 140 Number of poles: 8 Number of blades: 6

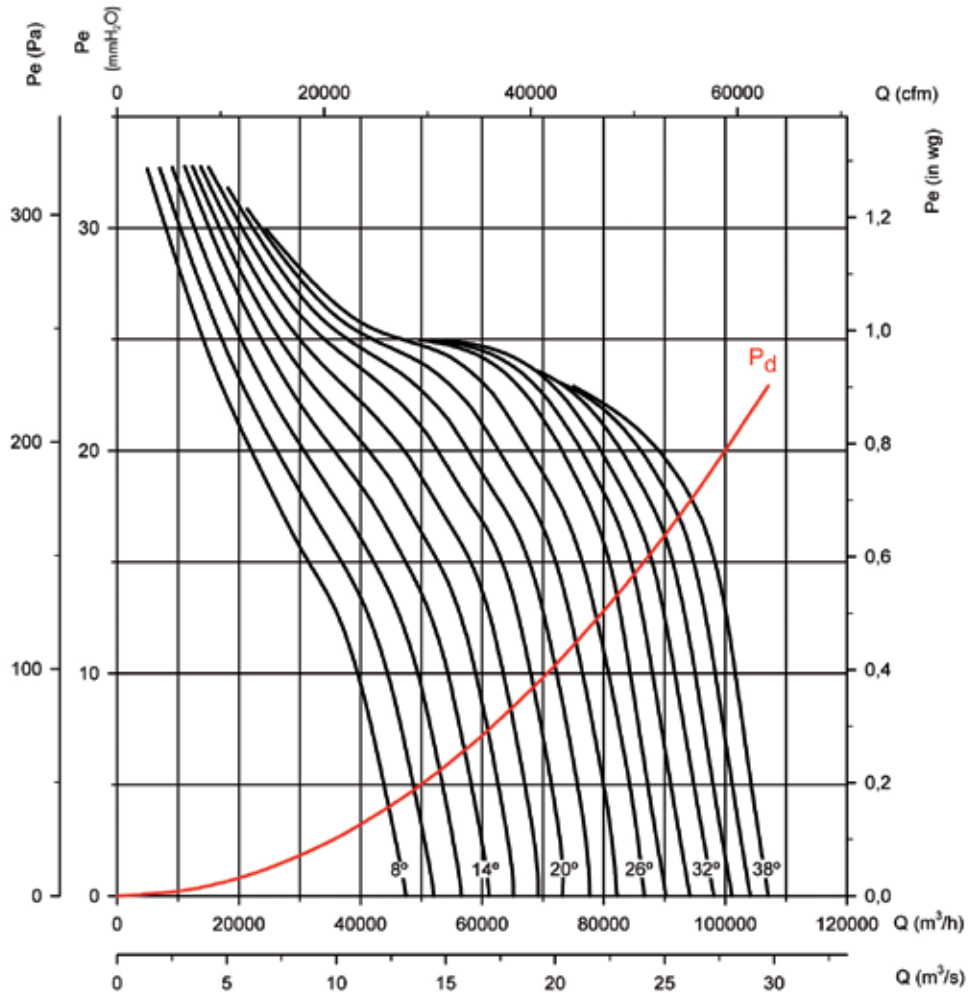

Absorbed power

Recommended motor power kW (CV)

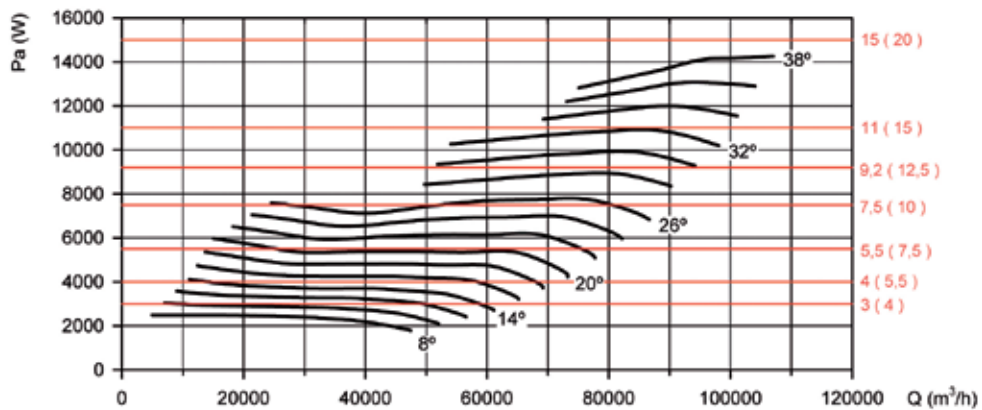

Available features best efficiency point (BEP) at the end of the series.

THT CJTHT/PLUS CJTHT CJTHT/DUPLEX/ATEX

Characteristic curves

THT

CJTHT/PLUS

CJTHT

CJTHT/DUPLEX/ATEX

Q = Airflow in m³/h, m³/s and cfm.

Pe = Static pressure in mm.w.c., Pa and inwg.

Impeller diameter (cm): 140

Number of poles: 8

Number of blades: 9

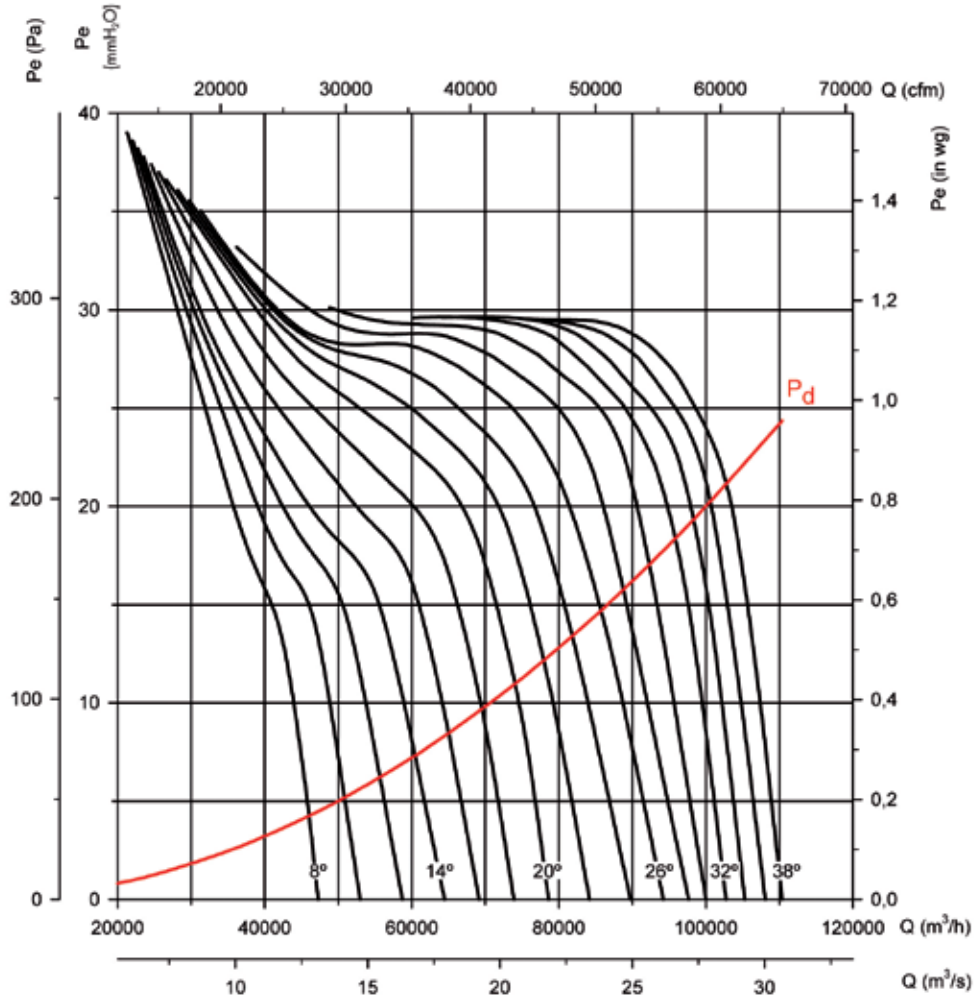

Absorbed power

Recommended motor power kW (CV)

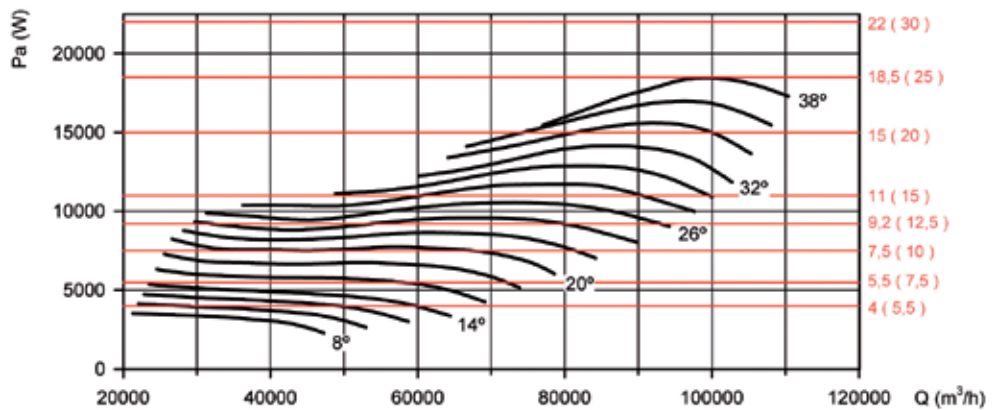

Available features best efficiency point (BEP) at the end of the series.

Characteristic curves

THT

CJTHT/PLUS

CJTHT

CJTHT/DUPLEX/ATEX

Q = Airflow in m³/h, m³/s and cfm.

Pe = Static pressure in mm.w.c., Pa and inwg.

Impeller diameter (cm): 160

Number of poles: 6

Number of blades: 3

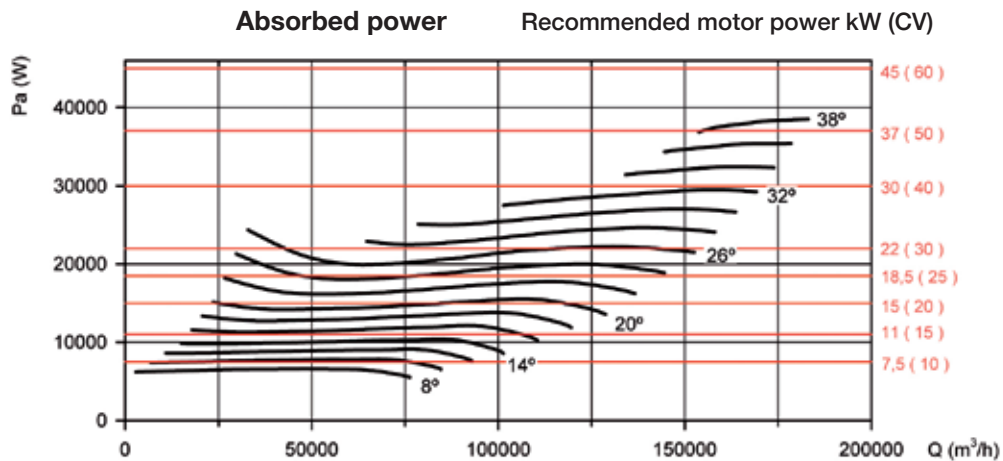
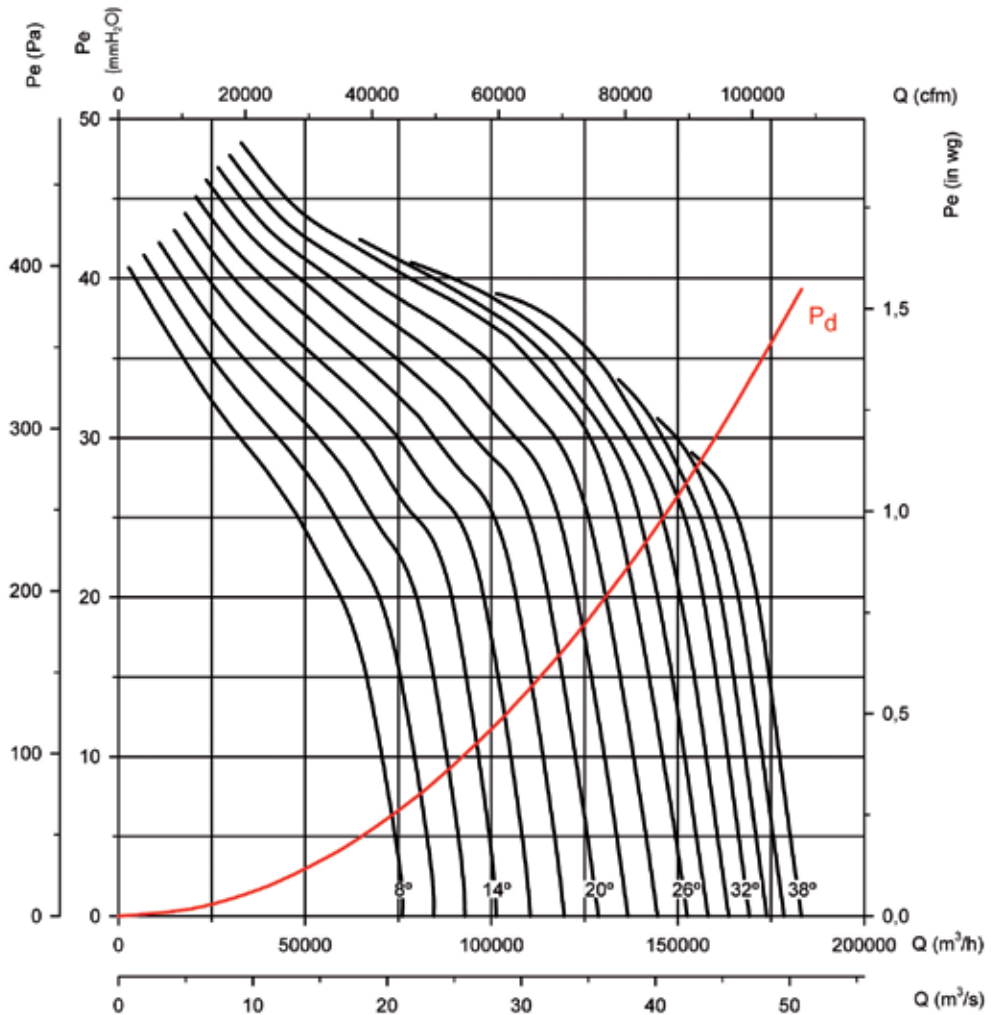

Available features best efficiency point (BEP) at the end of the series.

THT CJTHT/PLUS CJTHT CJTHT/DUPLEX/ATEX

Characteristic curves

THT

CJTHT/PLUS

CJTHT

CJTHT/DUPLEX/ATEX

Q = Airflow in m³/h, m³/s and cfm.

Pe = Static pressure in mm.w.c., Pa and inwg.

Impeller diameter (cm): 160

Number of poles: 6

Number of blades: 6

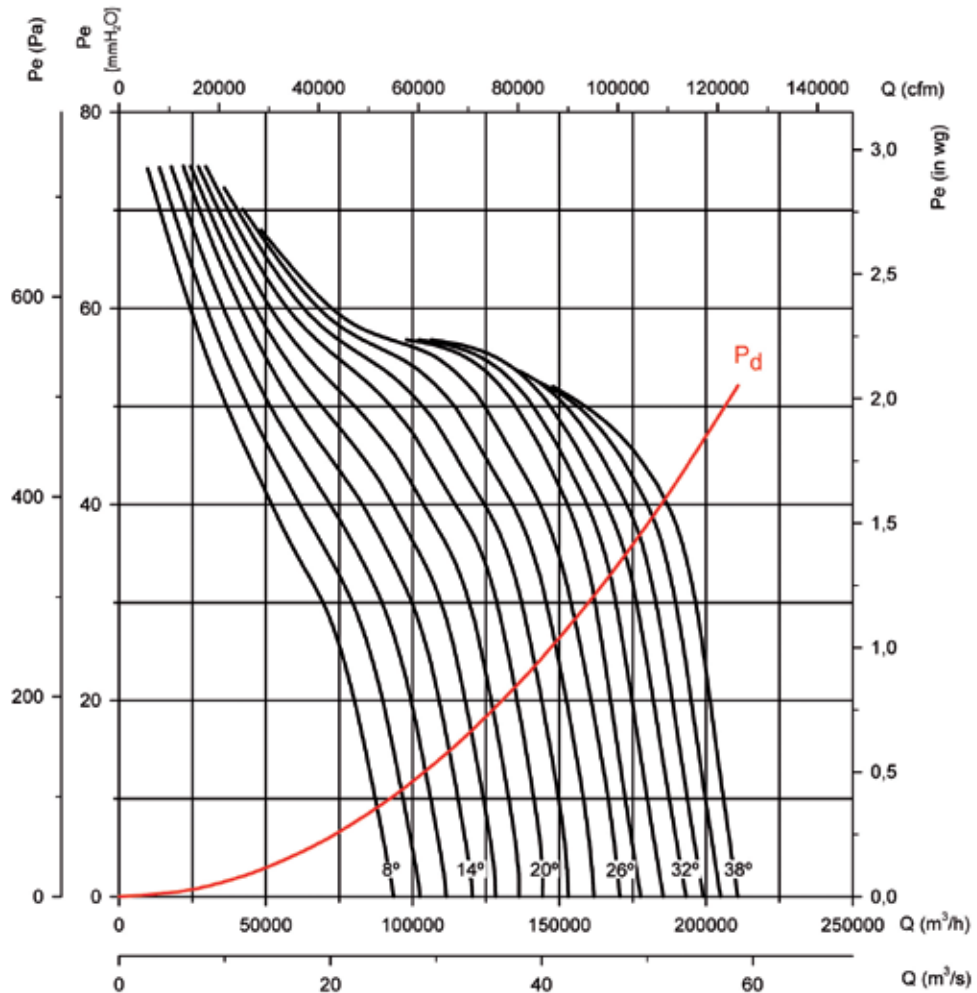

Absorbed power

Recommended motor power kW (CV)

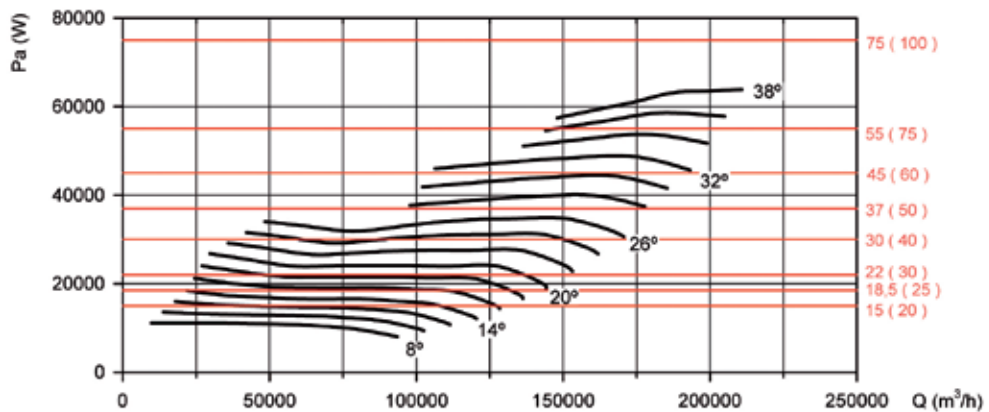

Available features best efficiency point (BEP) at the end of the series.

Characteristic curves

THT

CJTHT/PLUS

CJTHT

CJTHT/DUPLEX/ATEX

Q = Airflow in m³/h, m³/s and cfm.

Pe = Static pressure in mm.w.c., Pa and inwg.

Impeller diameter (cm): 160

Number of poles: 6

Number of blades: 9

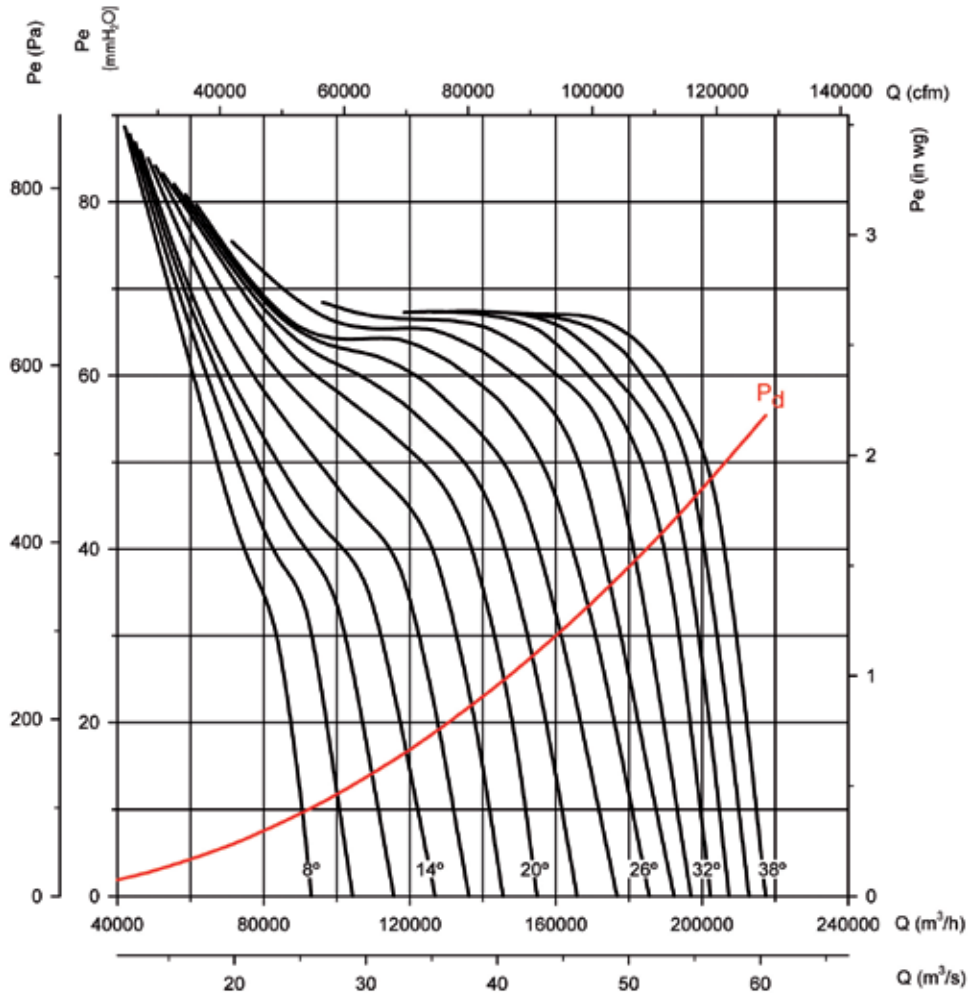

Absorbed power

Recommended motor power kW (CV)

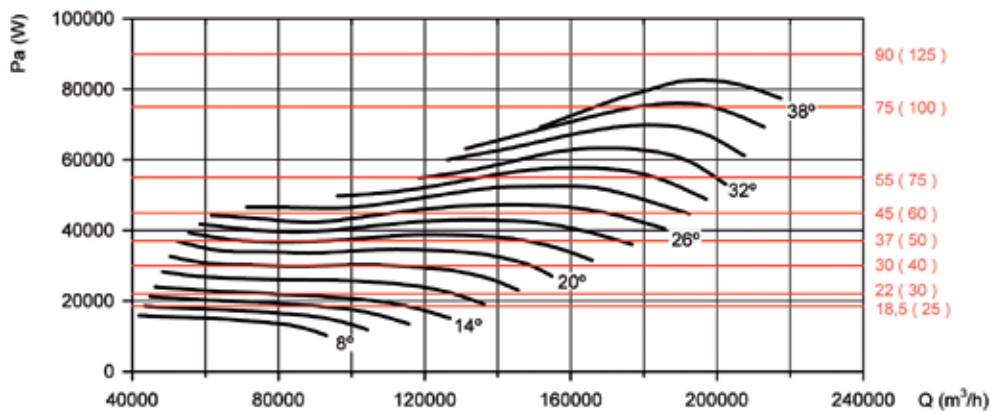

Available features best efficiency point (BEP) at the end of the series.

THT CJTHT/PLUS CJTHT CJTHT/DUPLEX/ATEX

Characteristic curves

THT

CJTHT/PLUS

CJTHT

CJTHT/DUPLEX/ATEX

Q = Airflow in m³/h, m³/s and cfm.

Pe = Static pressure in mm.w.c., Pa and inwg.

Impeller diameter (cm): 160

Number of poles: 8

Number of blades: 3

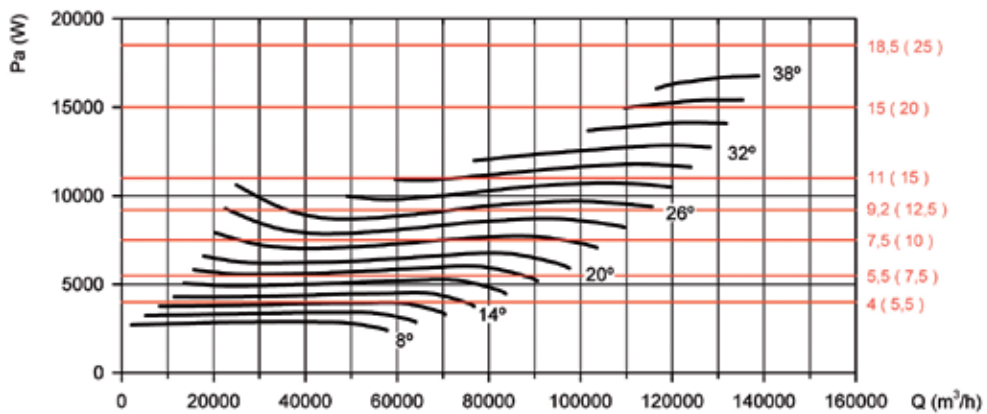
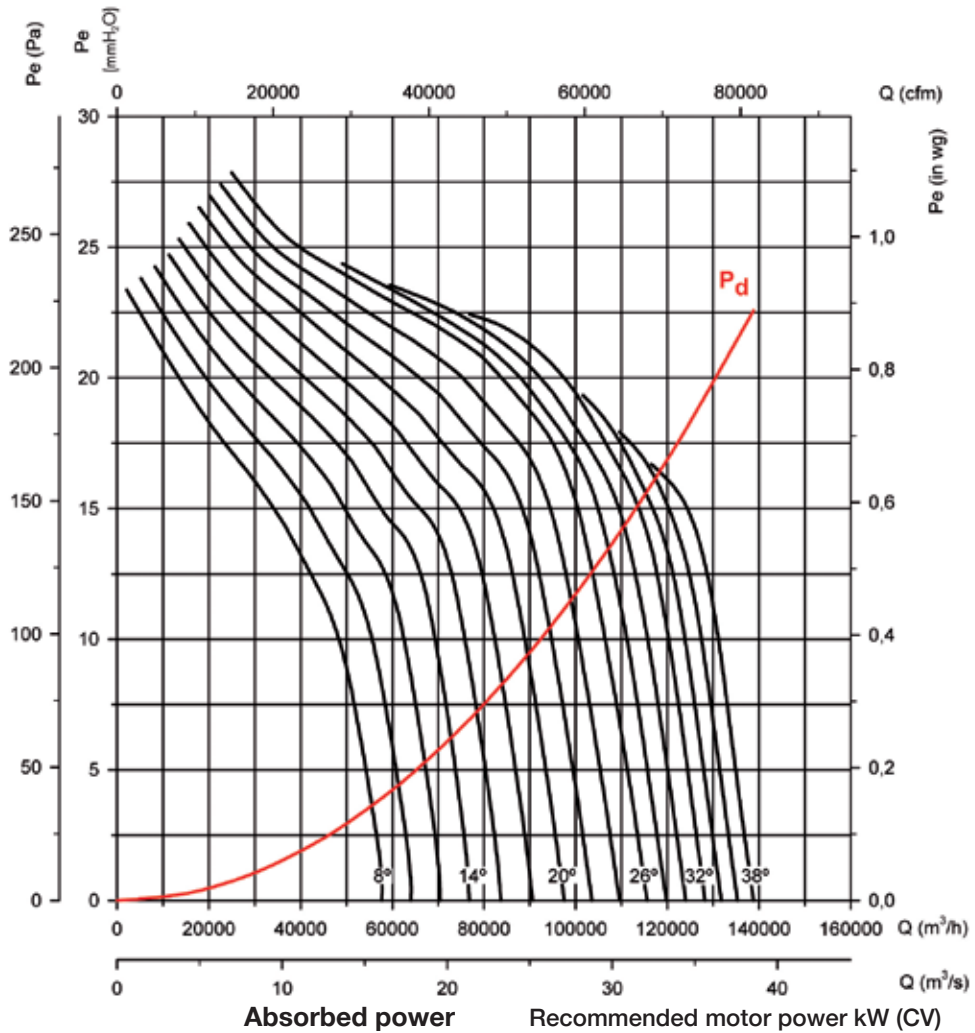

Available features best efficiency point (BEP) at the end of the series.

Characteristic curves

THT CJTHT/PLUS CJTHT CJTHT/DUPLEX/ATEX

Q = Airflow in m³/h, m³/s and cfm.

Pe = Static pressure in mm.w.c., Pa and inwg.

Impeller diameter (cm): 160 Number of poles: 8 Number of blades: 6

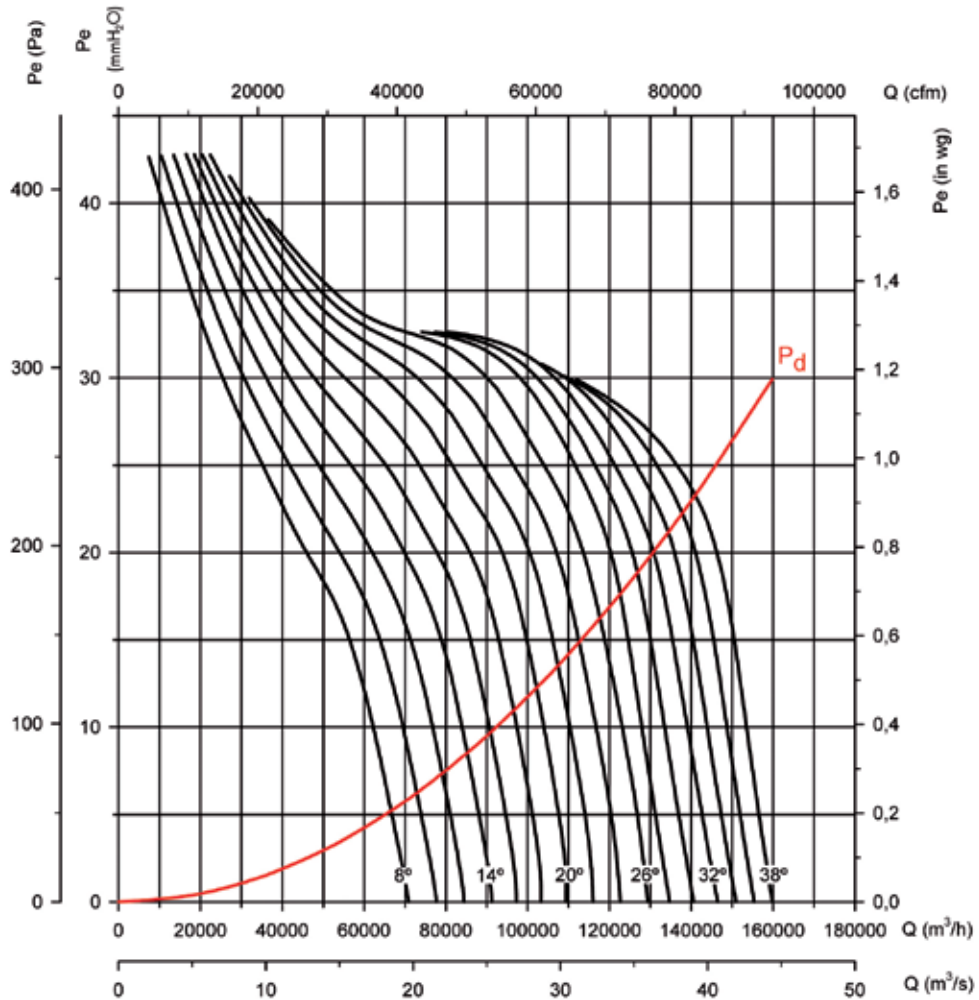

Absorbed power

Recommended motor power kW (CV)

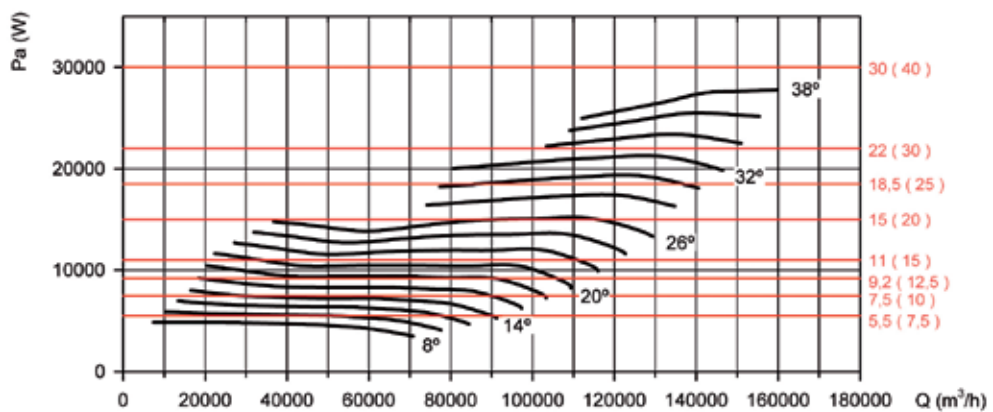

Available features best efficiency point (BEP) at the end of the series.

THT CJTHT/PLUS CJTHT CJTHT/DUPLEX/ATEX

Characteristic curves

THT CJTHT/PLUS CJTHT CJTHT/DUPLEX/ATEX

Q = Airflow in m³/h, m³/s and cfm.

Pe = Static pressure in mm.w.c., Pa and inwg.

Impeller diameter (cm): 160 Number of poles: 8 Number of blades: 9

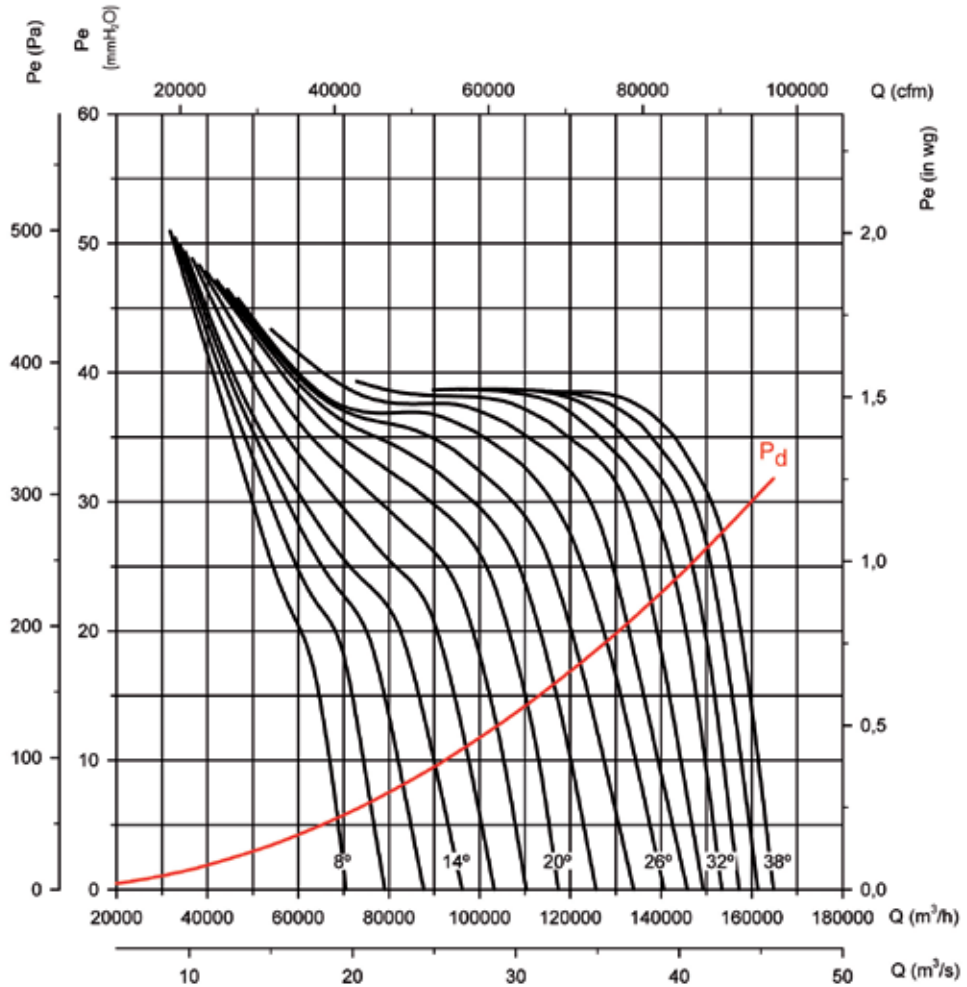

Absorbed power Recommended motor power kW (CV)

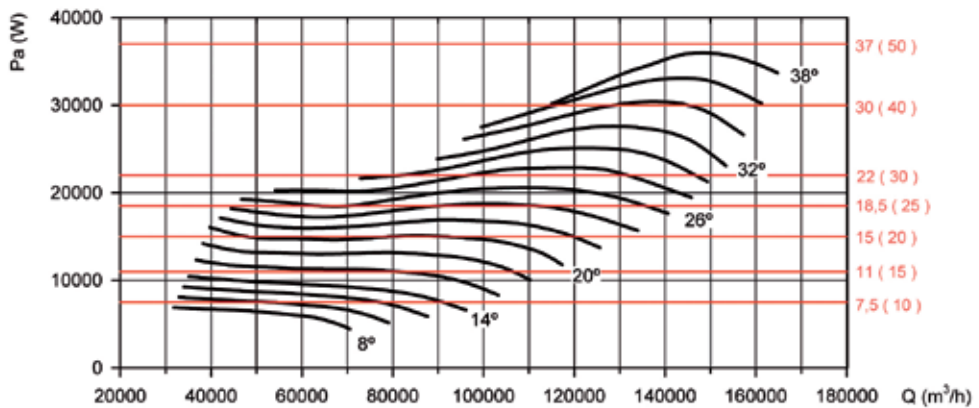

Available features best efficiency point (BEP) at the end of the series.



Erp. BEP (best efficiency point) characteristics

α [°]	Angle of inclination of the blades in degrees	SR	Specific relationship
PN	Motor's nominal power in kW	η_e [%]	Efficiency
MC	Measurement category	N	Degree of efficiency
EC	Efficiency category	[kW]	Electrical power
S	Static	[m³/h]	Airflow
T	Total	[mmH₂O]	Static or total pressure (According to EC)
VSD	Variable-speed drive	[RPM]	Speed

THT-40-2T

α [°]	PN	MC	EC	VSD	SR	η_e [%]	N	[kW]	[m³/h]	[mmH₂O]	[RPM]
8	0.55	A	S	NO	1.00	62.6%	71.8	0.350	2568	31.36	2906
10	0.55	A	S	NO	1.00	52.2%	60.4	0.502	2900	33.16	2866
12	0.55	A	S	NO	1.00	47.1%	54.8	0.601	3889	26.74	2839
14	0.75	A	S	NO	1.00	43.7%	50.8	0.780	3142	39.89	2831
16	0.75	A	S	NO	1.00	40.1%	46.5	0.967	4420	32.19	2791
18	1.1	A	S	NO	1.00	38.8%	44.8	1.129	4772	33.70	2918
20	1.1	A	S	NO	1.00	36.4%	41.9	1.334	5180	34.43	2903
22	1.5	A	S	NO	1.00	35.0%	40.2	1.506	5517	35.04	2951
24	1.5	A	S	NO	1.00	33.3%	38.1	1.699	5784	35.89	2945
26	2.2	A	S	NO	1.00	33.1%	37.8	1.816	6197	35.64	2952
28	2.2	A	S	NO	1.00	31.0%	35.4	2.026	6675	34.58	2946
30	2.2	A	S	NO	1.00	29.1%	33.3	2.228	7045	33.87	2941
32	2.2	B	T	NO	1.00	44.1%	48.1	2.318	8257	45.45	2939

THT-40-4T

α [°]	PN	MC	EC	VSD	SR	η_e [%]	N	[kW]	[m³/h]	[mmH₂O]	[RPM]
8	0.55	A	S	-	-	-	-	0.042	1284	7.84	1495
10	0.55	A	S	-	-	-	-	0.061	1339	9.01	1493
12	0.55	A	S	-	-	-	-	0.079	1425	9.60	1491
14	0.55	A	S	-	-	-	-	0.097	1571	9.97	1489
16	0.55	A	S	-	-	-	-	0.120	2210	8.05	1486
18	0.55	A	S	NO	1.00	38.0%	49.6	0.144	2386	8.43	1484
20	0.55	A	S	NO	1.00	36.1%	47.3	0.169	2564	8.71	1481
22	0.55	A	S	NO	1.00	33.5%	44.3	0.196	2758	8.76	1478
24	0.55	A	S	NO	1.00	32.3%	42.8	0.218	2939	8.80	1475
26	0.55	A	S	NO	1.00	31.0%	41.3	0.242	3099	8.91	1473
28	0.55	A	S	NO	1.00	29.1%	39.0	0.270	3337	8.65	1469
30	0.55	A	S	NO	1.00	27.3%	37.0	0.297	3522	8.47	1466
32	0.55	B	T	NO	1.00	41.3%	50.9	0.309	4129	11.36	1465

THT-40-6T

α [°]	PN	MC	EC	VSD	SR	η_e [%]	N	[kW]	[m³/h]	[mmH₂O]	[RPM]
8	0.55	A	S	-	-	-	-	0.012	841	3.37	999
10	0.55	A	S	-	-	-	-	0.018	877	3.87	999
12	0.55	A	S	-	-	-	-	0.023	934	4.12	998
14	0.55	A	S	-	-	-	-	0.028	1029	4.28	998
16	0.55	A	S	-	-	-	-	0.035	1448	3.45	997
18	0.55	A	S	-	-	-	-	0.042	1563	3.62	997
20	0.55	A	S	-	-	-	-	0.049	1680	3.74	996
22	0.55	A	S	-	-	-	-	0.057	1807	3.76	995
24	0.55	A	S	-	-	-	-	0.064	1895	3.85	995
26	0.55	A	S	-	-	-	-	0.071	1987	3.92	994
28	0.55	A	S	-	-	-	-	0.078	2186	3.71	994
30	0.55	A	S	-	-	-	-	0.086	2308	3.63	993
32	0.55	B	T	-	-	-	-	0.094	2422	3.61	992

THT CJTHT/PLUS CJTHT CJTHT/DUPLEX/ATEX

THT-45-2T

α [°]	PN	MC	EC	VSD	SR	ηe [%]	N	[kW]	[m³/h]	[mmH₂O]	[RPM]
8	0.55	A	S	NO	1.00	53.7%	61.1	0.689	4682	29.06	2816
10	0.75	A	S	NO	1.00	45.6%	52.1	0.938	4676	33.60	2797
12	1.1	A	S	NO	1.00	41.7%	47.7	1.131	5445	31.82	2918
14	1.1	A	S	NO	1.00	39.4%	44.9	1.347	6350	30.67	2902
16	1.5	A	S	NO	1.00	38.0%	43.1	1.593	6802	32.70	2948
18	2.2	A	S	NO	1.00	37.4%	42.0	1.822	7270	34.40	2952
20	2.2	A	S	NO	1.00	36.8%	41.0	2.112	7694	37.06	2944
22	2.2	A	S	NO	1.01	37.5%	41.4	2.417	8144	40.86	2936
24	3	A	S	NO	1.01	37.6%	41.3	2.682	8424	44.02	2939
26	3	A	S	NO	1.01	36.0%	39.4	2.968	8872	44.28	2933
28	3	A	S	NO	1.01	31.7%	34.8	3.334	9370	41.49	2925
30	4	B	T	NO	1.00	44.3%	47.2	3.571	11649	49.90	2946

THT-45-4T

α [°]	PN	MC	EC	VSD	SR	ηe [%]	N	[kW]	[m³/h]	[mmH₂O]	[RPM]
8	0.55	A	S	-	-	-	-	0.083	2341	7.26	1491
10	0.55	A	S	-	-	-	-	0.116	2338	8.40	1487
12	0.55	A	S	NO	1.00	40.9%	52.5	0.144	2742	7.89	1484
14	0.55	A	S	NO	1.00	38.6%	49.7	0.172	3175	7.67	1480
16	0.55	A	S	NO	1.00	36.5%	47.1	0.207	3401	8.17	1476
18	0.55	A	S	NO	1.00	35.0%	45.2	0.243	3635	8.60	1472
20	0.55	A	S	NO	1.00	34.9%	44.7	0.281	3947	9.14	1468
22	0.55	A	S	NO	1.00	34.4%	43.9	0.319	4027	10.01	1464
24	0.55	A	S	NO	1.00	34.2%	43.3	0.364	4316	10.59	1459
26	0.55	A	S	NO	1.00	33.8%	42.6	0.403	4312	11.62	1454
28	0.55	A	S	NO	1.00	29.3%	37.8	0.452	4685	10.37	1449
30	0.55	B	T	NO	1.00	40.3%	48.6	0.491	5825	12.48	1444
32	0.55	B	T	NO	1.00	39.0%	47.1	0.531	6243	12.19	1440
34	0.55	B	T	NO	1.00	38.8%	46.7	0.574	6470	12.66	1435
36	0.55	B	T	NO	1.00	38.5%	46.2	0.618	6694	13.06	1430
38	0.55	B	T	NO	1.00	38.2%	45.6	0.661	6877	13.48	1425

THT-45-6T

α [°]	PN	MC	EC	VSD	SR	ηe [%]	N	[kW]	[m³/h]	[mmH₂O]	[RPM]
8	0.55	A	S	-	-	-	-	0.024	1534	3.12	998
10	0.55	A	S	-	-	-	-	0.034	1532	3.61	997
12	0.55	A	S	-	-	-	-	0.042	1797	3.39	997
14	0.55	A	S	-	-	-	-	0.050	2080	3.29	996
16	0.55	A	S	-	-	-	-	0.060	2228	3.51	995
18	0.55	A	S	-	-	-	-	0.070	2382	3.69	994
20	0.55	A	S	-	-	-	-	0.081	2586	3.92	993
22	0.55	A	S	-	-	-	-	0.092	2644	4.41	992
24	0.55	A	S	-	-	-	-	0.105	2760	4.72	991
26	0.55	A	S	-	-	-	-	0.116	2826	4.97	990
28	0.55	A	S	NO	1.00	28.5%	40.4	0.131	3069	4.45	989
30	0.55	B	T	NO	1.00	39.2%	50.9	0.142	3816	5.36	988
32	0.55	B	T	NO	1.00	37.9%	49.4	0.154	4090	5.23	987
34	0.55	B	T	NO	1.00	37.8%	49.0	0.166	4239	5.43	986
36	0.55	B	T	NO	1.00	37.5%	48.5	0.179	4386	5.60	985
38	0.55	B	T	NO	1.00	37.1%	48.0	0.191	4506	5.79	984

THT-50-2T

α [°]	PN	MC	EC	VSD	SR	ηe [%]	N	[kW]	[m³/h]	[mmH₂O]	[RPM]
8	2.2	A	S	NO	1.00	40.3%	45.0	1.823	6883	39.24	2952
10	2.2	A	S	NO	1.00	38.0%	42.1	2.221	7275	42.60	2941
12	2.2	A	S	NO	1.00	36.8%	40.6	2.577	8011	43.55	2932
14	3	A	S	NO	1.01	36.5%	39.9	2.890	8704	44.52	2935
16	3	A	S	NO	1.01	34.4%	37.4	3.386	9218	46.38	2924
18	4	A	S	NO	1.01	33.2%	35.9	3.816	9715	47.89	2943
20	4	A	S	NO	1.01	31.7%	34.0	4.297	9906	50.43	2935
22	4	A	S	NO	1.01	30.7%	32.8	4.615	9091	57.23	2931
24	5.5	B	T	NO	1.00	44.1%	46.0	5.040	15830	51.58	2928
26	5.5	B	T	NO	1.01	44.7%	46.3	5.508	16933	53.40	2922
28	5.5	B	T	NO	1.01	43.7%	45.0	6.251	18159	55.30	2911
30	7.5	B	T	NO	1.01	44.2%	45.2	6.938	19309	58.31	2959
32	7.5	B	T	NO	1.01	44.3%	45.0	7.696	20591	60.82	2955

**Erp. BEP (best efficiency point) characteristics****THT-50-4T**

α [°]	PN	MC	EC	VSD	SR	ηe [%]	N	[kW]	[m³/h]	[mmH ₂ O]	[RPM]
8	0.55	A	S	NO	1.00	37.8%	48.0	0.243	3441	9.81	1472
10	0.55	A	S	NO	1.00	35.6%	45.3	0.296	3638	10.65	1466
12	0.55	A	S	NO	1.00	34.6%	43.8	0.344	4006	10.89	1461
14	0.55	A	S	NO	1.00	33.7%	42.6	0.392	4352	11.13	1456
16	0.55	A	S	NO	1.00	31.7%	40.2	0.459	4609	11.60	1448
18	0.55	A	S	NO	1.00	30.2%	38.3	0.525	4858	11.97	1440
20	0.55	A	S	NO	1.00	28.8%	36.6	0.591	4953	12.61	1433
22	0.55	A	S	NO	1.00	27.9%	35.5	0.634	4545	14.31	1428
24	0.55	B	T	NO	1.00	39.5%	46.8	0.703	7915	12.90	1420
26	0.75	B	T	NO	1.00	40.9%	48.0	0.753	8466	13.35	1444
28	0.75	B	T	NO	1.00	40.0%	46.8	0.854	9080	13.83	1437
30	1.1	B	T	NO	1.00	40.8%	47.3	0.939	9654	14.58	1458
32	1.1	B	T	NO	1.00	40.9%	47.1	1.041	10296	15.21	1454
34	1.1	B	T	NO	1.00	40.8%	46.8	1.161	11232	15.50	1448
36	1.1	B	T	NO	1.00	40.6%	46.2	1.302	11647	16.67	1442
38	1.5	B	T	NO	1.00	41.2%	46.6	1.420	12048	17.84	1453

THT-50-6T

α [°]	PN	MC	EC	VSD	SR	ηe [%]	N	[kW]	[m³/h]	[mmH ₂ O]	[RPM]
8	0.55	A	S	-	-	-	-	0.070	2255	4.21	994
10	0.55	A	S	-	-	-	-	0.086	2383	4.57	993
12	0.55	A	S	-	-	-	-	0.099	2624	4.67	992
14	0.55	A	S	-	-	-	-	0.113	2851	4.78	991
16	0.55	A	S	NO	1.00	30.8%	42.7	0.133	3020	4.98	989
18	0.55	A	S	NO	1.00	29.4%	40.9	0.152	3183	5.14	987
20	0.55	A	S	NO	1.00	28.0%	39.2	0.171	3245	5.41	986
22	0.55	A	S	NO	1.00	27.1%	38.1	0.183	2978	6.14	985
24	0.55	B	T	NO	1.00	38.5%	49.2	0.203	5186	5.54	983
26	0.55	B	T	NO	1.00	39.0%	49.4	0.222	5547	5.73	982
28	0.55	B	T	NO	1.00	38.1%	48.2	0.252	5949	5.93	979
30	0.55	B	T	NO	1.00	38.0%	47.8	0.283	6325	6.26	977
32	0.55	B	T	NO	1.00	38.1%	47.6	0.314	6745	6.53	974
34	0.55	B	T	NO	1.00	38.1%	47.3	0.350	7359	6.65	971
36	0.55	B	T	NO	1.00	37.8%	46.7	0.393	7631	7.16	967
38	0.55	B	T	NO	1.00	37.8%	46.4	0.436	7894	7.66	964

THT-56-2T

α [°]	PN	MC	EC	VSD	SR	ηe [%]	N	[kW]	[m³/h]	[mmH ₂ O]	[RPM]
8	2.2	A	S	NO	1.00	58.8%	63.2	1.998	9846	43.83	2947
10	2.2	A	S	NO	1.01	53.7%	57.5	2.516	10679	46.48	2933
12	3	A	S	NO	1.01	50.4%	53.7	3.075	11114	51.27	2931
14	4	A	S	NO	1.01	49.1%	51.9	3.547	11978	53.38	2947
16	4	A	S	NO	1.01	45.3%	47.7	4.212	12896	54.34	2937
18	5.5	A	S	NO	1.01	43.0%	45.0	4.831	14184	53.78	2931
20	5.5	A	S	NO	1.01	42.8%	44.4	5.527	14979	57.97	2921
22	5.5	A	S	NO	1.01	40.7%	42.1	6.123	15917	57.53	2913
24	7.5	A	S	NO	1.01	39.0%	40.1	6.641	16159	58.84	2961
26	7.5	A	S	NO	1.01	38.6%	39.5	7.220	16918	60.47	2958
28	7.5	B	T	NO	1.01	54.7%	55.3	8.171	22277	73.70	2952
30	11	B	T	NO	1.01	52.8%	53.1	9.148	23259	76.30	2952
32	11	B	T	NO	1.01	51.1%	51.1	10.225	24598	77.96	2946
34	11	B	T	NO	1.01	49.8%	49.8	11.302	25738	80.28	2940
36	15	B	T	NO	1.01	49.9%	49.8	12.244	27684	81.05	2971
38	15	B	T	NO	1.01	49.4%	49.3	13.318	28598	84.53	2968
40	15	B	T	NO	1.01	47.2%	47.0	14.400	29153	85.69	2965
42	15	B	T	NO	1.01	45.7%	45.4	15.620	30493	85.95	2962

THT CJTHT/PLUS CJTHT CJTHT/DUPLEX/ATEX



Erp. BEP (best efficiency point) characteristics

THT-56-4T

α [°]	PN	MC	EC	VSD	SR	ηe [%]	N	[kW]	[m³/h]	[mmH₂O]	[RPM]
8	0.55	A	S	NO	1.00	55.1%	65.1	0.266	4923	10.96	1470
10	0.55	A	S	NO	1.00	50.4%	59.7	0.335	5339	11.62	1462
12	0.55	A	S	NO	1.00	46.5%	55.2	0.417	5557	12.82	1453
14	0.55	A	S	NO	1.00	44.6%	52.9	0.488	5989	13.35	1445
16	0.55	A	S	NO	1.00	41.2%	49.0	0.579	6448	13.58	1434
18	0.55	A	S	NO	1.00	38.5%	45.9	0.674	7092	13.45	1424
20	0.75	A	S	NO	1.00	39.1%	46.2	0.755	7489	14.49	1444
22	0.75	A	S	NO	1.00	37.2%	44.1	0.837	7959	14.38	1438
24	0.75	A	S	NO	1.00	35.2%	41.8	0.919	8079	14.71	1432
26	1.1	A	S	NO	1.00	35.6%	42.0	0.977	8459	15.12	1457
28	1.1	B	T	NO	1.00	50.5%	56.6	1.106	11138	18.42	1451
30	1.1	B	T	NO	1.00	48.1%	53.8	1.255	11629	19.08	1444
32	1.5	B	T	NO	1.00	47.3%	52.7	1.380	12299	19.49	1454
34	1.5	B	T	NO	1.00	46.1%	51.3	1.525	12869	20.07	1450
36	1.5	B	T	NO	1.00	45.6%	50.5	1.670	13581	20.60	1445
38	2.2	B	T	NO	1.00	45.9%	50.7	1.780	14043	21.38	1456
40	2.2	B	T	NO	1.00	44.1%	48.7	1.926	14576	21.42	1452
42	2.2	B	T	NO	1.00	42.7%	47.0	2.089	15246	21.49	1448
44	2.2	B	T	NO	1.00	42.0%	46.0	2.308	16393	21.70	1442

THT-56-6T

α [°]	PN	MC	EC	VSD	SR	ηe [%]	N	[kW]	[m³/h]	[mmH₂O]	[RPM]
8	0.55	A	S	-	-	-	-	0.077	3225	4.70	994
10	0.55	A	S	-	-	-	-	0.097	3498	4.99	992
12	0.55	A	S	-	-	-	-	0.121	3641	5.50	990
14	0.55	A	S	NO	1.00	43.4%	55.1	0.141	3924	5.73	988
16	0.55	A	S	NO	1.00	40.1%	51.3	0.167	4225	5.83	986
18	0.55	A	S	NO	1.00	37.5%	48.3	0.195	4646	5.77	984
20	0.55	A	S	NO	1.00	37.3%	47.7	0.223	4907	6.22	982
22	0.55	A	S	NO	1.00	35.5%	45.7	0.247	5214	6.17	980
24	0.55	A	S	NO	1.00	33.6%	43.5	0.271	5293	6.31	978
26	0.55	A	S	NO	1.00	33.2%	42.9	0.295	5542	6.49	976
28	0.55	B	T	NO	1.00	47.1%	56.4	0.334	7298	7.91	972
30	0.55	B	T	NO	1.00	44.8%	53.8	0.379	7619	8.19	969
32	0.55	B	T	NO	1.00	43.4%	52.0	0.423	8058	8.37	965
34	0.55	B	T	NO	1.00	42.3%	50.7	0.468	8431	8.61	961
36	0.55	B	T	NO	1.00	41.9%	50.1	0.512	9069	8.70	958
38	0.55	B	T	NO	1.00	41.5%	49.5	0.557	9368	9.07	954
40	0.55	B	T	NO	1.00	39.7%	47.4	0.602	9550	9.20	950
42	0.55	B	T	NO	1.00	38.4%	45.9	0.653	9989	9.22	946
44	0.55	B	T	NO	1.00	37.8%	45.0	0.721	10740	9.32	940

THT-63-2T

α [°]	PN	MC	EC	VSD	SR	ηe [%]	N	[kW]	[m³/h]	[mmH₂O]	[RPM]
8	4	C	S	NO	1.01	48.2%	50.3	4.647	13801	59.58	2930
10	5.5	C	S	NO	1.01	47.7%	49.5	5.240	15062	60.95	2925
12	5.5	C	S	NO	1.01	47.0%	48.4	5.900	16392	62.10	2916
14	7.5	C	S	NO	1.01	47.2%	48.4	6.481	17777	63.16	2962
16	7.5	C	S	NO	1.01	46.3%	47.2	7.270	19115	64.69	2957
18	7.5	C	S	NO	1.01	47.0%	47.6	8.043	19736	70.39	2953
20	11	C	S	NO	1.01	47.9%	48.3	8.699	20827	73.50	2954
22	11	C	S	NO	1.01	44.4%	44.5	10.183	22211	74.82	2946
24	11	C	S	NO	1.01	41.3%	41.3	11.648	23509	75.23	2938
26	15	C	S	NO	1.01	39.1%	39.0	13.056	24775	75.68	2969
28	15	B	T	NO	1.01	59.9%	59.7	14.890	35881	91.36	2964
30	18.5	B	T	NO	1.01	58.8%	58.5	16.674	37937	94.99	2951
32	18.5	B	T	NO	1.01	58.0%	57.6	18.487	40069	98.35	2946
34	18.5	B	T	NO	1.01	57.6%	57.2	19.943	44238	95.40	2941
36	22	B	T	NO	1.01	57.8%	57.3	21.625	45504	100.94	2955
38	22	B	T	NO	1.01	58.2%	57.7	23.397	46829	106.91	2951

**Erp. BEP (best efficiency point) characteristics****THT-63-4T**

α [°]	PN	MC	EC	VSD	SR	ηe [%]	N	[kW]	[m³/h]	[mmH ₂ O]	[RPM]
8	0.55	C	S	NO	1.00	49.4%	57.1	0.605	7675	14.31	1431
10	0.75	C	S	NO	1.00	48.9%	56.2	0.695	7963	15.67	1448
12	0.75	C	S	NO	1.00	50.0%	57.0	0.781	8606	16.66	1442
14	0.75	C	S	NO	1.00	49.8%	56.5	0.868	9291	17.07	1436
16	1.1	C	S	NO	1.00	48.2%	54.6	0.966	9692	17.64	1457
18	1.1	C	S	NO	1.00	48.0%	54.1	1.078	10219	18.59	1452
20	1.1	C	S	NO	1.00	47.9%	53.7	1.193	10625	19.76	1447
22	1.5	C	S	NO	1.00	45.0%	50.5	1.360	11327	19.86	1455
24	1.5	C	S	NO	1.00	42.3%	47.4	1.551	12026	20.03	1449
26	1.5	C	S	NO	1.00	40.3%	45.1	1.748	12561	20.60	1442
28	2.2	B	T	NO	1.00	64.2%	68.7	1.953	18581	24.78	1451
30	2.2	B	T	NO	1.00	62.7%	66.9	2.201	19481	26.02	1445
32	2.2	B	T	NO	1.00	61.9%	65.8	2.447	20324	27.38	1439
34	3	B	T	NO	1.00	61.8%	65.5	2.610	21482	27.57	1448
36	3	B	T	NO	1.00	61.7%	65.2	2.810	22995	27.71	1444
38	3	B	T	NO	1.00	62.6%	65.9	3.020	24239	28.64	1440

THT-63-6T

α [°]	PN	MC	EC	VSD	SR	ηe [%]	N	[kW]	[m³/h]	[mmH ₂ O]	[RPM]
8	0.55	C	S	NO	1.00	48.1%	59.2	0.175	5028	6.14	986
10	0.55	C	S	NO	1.00	46.6%	57.3	0.205	5217	6.73	983
12	0.55	C	S	NO	1.00	47.6%	58.0	0.231	5639	7.15	981
14	0.55	C	S	NO	1.00	47.4%	57.5	0.256	6087	7.33	979
16	0.55	C	S	NO	1.00	44.9%	54.6	0.291	6350	7.57	976
18	0.55	C	S	NO	1.00	44.7%	54.1	0.325	6695	7.98	973
20	0.55	C	S	NO	1.00	44.6%	53.8	0.360	6961	8.48	970
22	0.55	C	S	NO	1.00	41.3%	50.0	0.417	7421	8.53	965
24	0.55	C	S	NO	1.00	38.8%	47.1	0.476	7879	8.60	961
26	0.55	C	S	NO	1.00	36.9%	45.0	0.536	8230	8.84	956
28	0.55	B	T	NO	1.00	57.7%	65.4	0.611	12174	10.64	949
30	0.55	B	T	NO	1.00	56.4%	63.7	0.688	12764	11.17	943
32	0.75	B	T	NO	1.00	57.3%	64.5	0.743	13316	11.75	954
34	0.75	B	T	NO	1.00	56.4%	63.3	0.804	14075	11.84	950
36	0.75	B	T	NO	1.00	56.4%	63.1	0.865	15066	11.90	946
38	0.75	B	T	NO	1.00	57.1%	63.7	0.930	15880	12.29	942

THT-71-4T

α [°]	PN	MC	EC	VSD	SR	ηe [%]	N	[kW]	[m³/h]	[mmH ₂ O]	[RPM]
8	1.1	C	S	NO	1.00	50.2%	56.5	0.999	10244	17.99	1456
10	1.1	C	S	NO	1.00	48.7%	54.5	1.172	11274	18.59	1448
12	1.1	C	S	NO	1.00	47.9%	53.4	1.346	12330	19.20	1440
14	1.5	C	S	NO	1.00	48.4%	53.6	1.495	13405	19.83	1450
16	1.5	C	S	NO	1.00	45.8%	50.6	1.717	14522	19.88	1443
18	2.2	C	S	NO	1.00	45.2%	49.8	1.906	15360	20.62	1452
20	2.2	C	S	NO	1.00	44.8%	49.1	2.168	16397	21.78	1446
22	2.2	C	S	NO	1.00	42.8%	46.8	2.369	17056	21.84	1441
24	2.2	C	S	NO	1.00	42.2%	45.9	2.566	17819	22.30	1436
26	3	C	S	NO	1.00	42.1%	45.6	2.734	18933	22.31	1445
28	3	C	S	NO	1.00	40.7%	44.0	2.976	19369	22.96	1441
30	3	C	S	NO	1.00	38.7%	41.8	3.225	19849	23.10	1436
32	3	C	S	NO	1.00	37.3%	40.2	3.456	20418	23.20	1431
34	4	C	S	NO	1.00	36.2%	39.0	3.681	21714	22.57	1460
36	4	B	T	NO	1.00	64.6%	67.0	4.158	28986	34.02	1455
38	4	B	T	NO	1.00	62.8%	65.0	4.510	29926	34.78	1451

THT CJTHT/PLUS CJTHT CJTHT/DUPLEX/ATEX



Erp. BEP (best efficiency point) characteristics

THT-71-6T

α [°]	PN	MC	EC	VSD	SR	ηe [%]	N	[kW]	[m³/h]	[mmH₂O]	[RPM]
8	0.55	C	S	NO	1.00	46.8%	56.4	0.302	6712	7.72	975
10	0.55	C	S	NO	1.00	45.3%	54.5	0.354	7386	7.98	971
12	0.55	C	S	NO	1.00	44.6%	53.4	0.406	8078	8.24	966
14	0.55	C	S	NO	1.00	44.4%	52.8	0.459	8783	8.51	962
16	0.55	C	S	NO	1.00	42.0%	50.1	0.527	9514	8.53	956
18	0.55	C	S	NO	1.00	40.7%	48.4	0.596	10063	8.85	951
20	0.55	C	S	NO	1.00	40.3%	47.7	0.678	10743	9.35	944
22	0.75	C	S	NO	1.00	39.6%	46.9	0.720	11175	9.37	955
24	0.75	C	S	NO	1.00	39.0%	46.1	0.779	11674	9.57	951
26	0.75	C	S	NO	1.00	38.4%	45.2	0.842	12404	9.58	947
28	0.75	C	S	NO	1.00	37.1%	43.7	0.916	12690	9.86	943
30	1.1	C	S	NO	1.00	36.1%	42.5	0.972	13005	9.92	961
32	1.1	C	S	NO	1.00	34.8%	41.0	1.041	13377	9.96	958
34	1.1	C	S	NO	1.00	33.4%	39.4	1.123	14226	9.69	955
36	1.1	B	T	NO	1.00	59.5%	65.2	1.268	18991	14.60	949
38	1.1	B	T	NO	1.00	57.9%	63.4	1.376	19607	14.93	945

THT-80-4T

α [°]	PN	MC	EC	VSD	SR	ηe [%]	N	[kW]	[m³/h]	[mmH₂O]	[RPM]
8	1.5	C	S	NO	1.00	51.0%	55.9	1.683	13964	22.58	1444
10	2.2	C	S	NO	1.00	49.4%	53.8	1.987	15817	22.78	1450
12	2.2	C	S	NO	1.00	47.0%	51.0	2.417	16923	24.69	1440
14	3	C	S	NO	1.00	47.2%	50.7	2.746	18703	25.45	1445
16	3	C	S	NO	1.00	44.5%	47.4	3.404	20444	27.19	1432
18	4	C	S	NO	1.00	43.6%	46.1	4.011	22304	28.78	1457
20	5.5	C	S	NO	1.00	43.7%	45.8	4.605	23848	30.98	1474
22	5.5	C	S	NO	1.00	44.7%	46.6	4.902	24787	32.44	1473
24	5.5	C	S	NO	1.00	42.9%	44.6	5.410	25791	33.05	1470
26	5.5	C	S	NO	1.00	42.0%	43.5	5.852	26826	33.68	1467
28	7.5	C	S	NO	1.00	41.1%	42.3	6.423	27918	34.75	1473
30	7.5	C	S	NO	1.01	40.4%	41.4	7.090	29984	35.12	1471
32	7.5	C	S	NO	1.01	39.5%	40.2	7.743	31204	35.97	1468

THT-80-6T

α [°]	PN	MC	EC	VSD	SR	ηe [%]	N	[kW]	[m³/h]	[mmH₂O]	[RPM]
8	1.1	C	S	NO	1.00	49.2%	57.5	0.491	9149	9.69	980
10	1.1	C	S	NO	1.00	46.7%	54.5	0.591	10363	9.78	976
12	1.1	C	S	NO	1.00	44.5%	51.8	0.718	11087	10.60	971
14	1.1	C	S	NO	1.00	44.0%	50.9	0.828	12254	10.92	967
16	1.1	C	S	NO	1.00	41.5%	47.7	1.026	13395	11.67	959
18	1.1	C	S	NO	1.00	40.2%	45.9	1.224	14613	12.35	951
20	1.5	C	S	NO	1.00	40.8%	46.2	1.388	15625	13.30	970
22	1.5	C	S	NO	1.00	41.7%	46.9	1.478	16240	13.93	968
24	1.5	C	S	NO	1.00	40.0%	45.0	1.631	16897	14.19	964
26	1.5	C	S	NO	1.00	39.2%	44.0	1.764	17576	14.46	962
28	2.2	C	S	NO	1.00	38.6%	43.2	1.922	18291	14.92	964
30	2.2	C	S	NO	1.00	38.0%	42.3	2.122	19645	15.07	960
32	2.2	C	S	NO	1.00	37.1%	41.1	2.317	20444	15.44	956

THT-80-8T

α [°]	PN	MC	EC	VSD	SR	ηe [%]	N	[kW]	[m³/h]	[mmH₂O]	[RPM]
8	0.55	C	S	NO	1.00	39.4%	49.4	0.266	6934	5.57	734
10	0.55	C	S	NO	1.00	37.5%	46.9	0.321	7854	5.62	731
12	0.55	C	S	NO	1.00	35.7%	44.6	0.390	8403	6.09	727
14	0.55	C	S	NO	1.00	35.3%	43.8	0.449	9287	6.27	724
16	0.55	C	S	NO	1.00	33.3%	41.2	0.557	10152	6.70	718
18	0.55	C	S	NO	1.00	32.2%	39.6	0.664	11075	7.10	711
20	0.55	C	S	NO	1.00	31.9%	38.9	0.772	11842	7.64	705
22	0.55	C	S	NO	1.00	32.6%	39.5	0.822	12308	8.00	702
24	0.75	C	S	NO	1.00	36.2%	43.2	0.785	12806	8.15	719
26	0.75	C	S	NO	1.00	35.5%	42.3	0.849	13321	8.30	717
28	0.75	C	S	NO	1.00	34.3%	40.8	0.942	13863	8.57	713
30	1.1	C	S	NO	1.00	34.2%	40.5	1.026	14889	8.66	715
32	1.1	C	S	NO	1.00	33.4%	39.4	1.121	15494	8.87	712

**Erp. BEP (best efficiency point) characteristics****THT-90-4T**

α [°]	PN	MC	EC	VSD	SR	ηe [%]	N	[kW]	[m³/h]	[mmH₂O]	[RPM]
8	3	C	S	NO	1.00	51.9%	55.2	3.028	19656	29.36	1440
10	3	C	S	NO	1.00	51.1%	54.0	3.468	23364	27.87	1431
12	4	C	S	NO	1.00	50.5%	53.0	4.049	25081	29.94	1456
14	4	C	S	NO	1.00	50.8%	52.9	4.602	27678	31.02	1450
16	5.5	C	S	NO	1.00	49.1%	50.8	5.393	29635	32.80	1470
18	5.5	C	S	NO	1.00	47.7%	49.0	6.251	31521	34.72	1465
20	7.5	C	S	NO	1.00	46.8%	47.8	7.035	33277	36.37	1471
22	7.5	C	S	NO	1.01	45.2%	45.9	7.879	35009	37.36	1467
24	11	C	S	NO	1.01	44.3%	44.8	8.627	36254	38.77	1479
26	11	C	S	NO	1.01	43.6%	43.7	9.577	37545	40.84	1477
28	11	C	S	NO	1.01	41.7%	41.7	10.667	39574	41.28	1474
30	11	C	S	NO	1.01	40.0%	40.0	11.780	41490	41.74	1471
32	15	C	S	NO	1.01	39.0%	38.9	12.781	43446	42.17	1477

THT-90-6T

α [°]	PN	MC	EC	VSD	SR	ηe [%]	N	[kW]	[m³/h]	[mmH₂O]	[RPM]
8	1.5	C	S	NO	1.00	49.6%	56.3	0.891	12878	12.60	981
10	1.5	C	S	NO	1.00	48.9%	55.1	1.020	15307	11.96	978
12	1.5	C	S	NO	1.00	47.7%	53.5	1.205	16432	12.85	974
14	1.5	C	S	NO	1.00	48.0%	53.5	1.370	18134	13.31	970
16	1.5	C	S	NO	1.00	45.8%	50.8	1.625	19416	14.08	965
18	2.2	C	S	NO	1.00	45.3%	49.9	1.850	20652	14.90	965
20	2.2	C	S	NO	1.00	44.0%	48.3	2.106	21802	15.61	960
22	2.2	C	S	NO	1.00	42.5%	46.4	2.358	22937	16.04	955
24	2.2	C	S	NO	1.00	41.1%	44.8	2.615	23753	16.64	950
26	3	C	S	NO	1.00	41.1%	44.5	2.858	24599	17.53	976
28	3	C	S	NO	1.00	39.3%	42.4	3.183	25928	17.72	973
30	3	C	S	NO	1.00	37.7%	40.6	3.515	27183	17.92	970
32	4	C	S	NO	1.00	37.0%	39.7	3.789	28464	18.10	976

THT-90-8T

α [°]	PN	MC	EC	VSD	SR	ηe [%]	N	[kW]	[m³/h]	[mmH₂O]	[RPM]
8	0.75	C	S	NO	1.00	44.9%	53.5	0.429	9760	7.24	733
10	0.75	C	S	NO	1.00	44.2%	52.5	0.491	11601	6.87	731
12	0.75	C	S	NO	1.00	43.1%	51.0	0.580	12454	7.38	727
14	0.75	C	S	NO	1.00	43.4%	50.9	0.659	13744	7.65	724
16	0.75	C	S	NO	1.00	41.4%	48.4	0.782	14716	8.09	719
18	0.75	C	S	NO	1.00	40.2%	46.8	0.907	15652	8.56	714
20	1.1	C	S	NO	1.00	39.6%	45.9	1.018	16524	8.97	715
22	1.1	C	S	NO	1.00	38.2%	44.2	1.140	17384	9.21	711
24	1.1	C	S	NO	1.00	37.0%	42.7	1.264	18002	9.56	707
26	1.1	C	S	NO	1.00	36.4%	41.8	1.404	18643	10.07	702
28	1.5	C	S	NO	1.00	36.7%	41.9	1.484	19650	10.18	719
30	1.5	C	S	NO	1.00	35.2%	40.2	1.639	20602	10.29	715
32	1.5	C	S	NO	1.00	34.0%	38.7	1.795	21573	10.40	712

THT-100-4T

α [°]	PN	MC	EC	VSD	SR	ηe [%]	N	[kW]	[m³/h]	[mmH₂O]	[RPM]
8	4	C	S	NO	1.00	55.5%	57.8	4.250	28902	29.96	1454
10	5.5	C	S	NO	1.00	52.1%	53.9	5.240	30466	32.94	1471
12	5.5	C	S	NO	1.00	50.3%	51.6	6.210	32807	34.96	1465
14	7.5	C	S	NO	1.00	49.9%	50.9	7.100	35267	36.91	1471
16	7.5	C	S	NO	1.00	47.9%	48.5	8.268	37591	38.73	1466
18	11	C	S	NO	1.01	47.3%	47.5	9.324	39898	40.62	1477
20	11	C	S	NO	1.01	46.6%	46.6	10.492	42175	42.59	1474
22	11	C	S	NO	1.01	43.9%	43.9	12.052	44571	43.65	1470
24	15	C	S	NO	1.01	42.4%	42.2	13.415	47975	43.55	1476
26	15	C	S	NO	1.01	41.0%	40.8	14.939	49411	45.57	1473
28	15	C	S	NO	1.01	40.0%	39.8	16.186	50259	47.37	1471
30	18.5	B	T	NO	1.01	63.4%	63.1	17.435	67547	60.14	1474
32	18.5	B	T	NO	1.00	63.4%	63.0	17.976	81688	51.24	1473

THT CJTHT/PLUS CJTHT CJTHT/DUPLEX/ATEX



Erp. BEP (best efficiency point) characteristics

THT-100-6T

α [°]	PN	MC	EC	VSD	SR	ηe [%]	N	[kW]	[m³/h]	[mmH₂O]	[RPM]
8	2.2	C	S	NO	1.00	53.4%	59.1	1.242	18936	12.86	976
10	2.2	C	S	NO	1.00	49.5%	54.7	1.551	19961	14.14	971
12	2.2	C	S	NO	1.00	47.8%	52.4	1.838	21494	15.01	965
14	2.2	C	S	NO	1.00	46.9%	51.2	2.125	23106	15.84	960
16	2.2	C	S	NO	1.00	45.0%	48.9	2.474	24629	16.62	953
18	3	C	S	NO	1.00	44.6%	48.1	2.782	26140	17.44	976
20	3	C	S	NO	1.00	43.9%	47.1	3.131	27632	18.28	974
22	4	C	S	NO	1.00	42.1%	45.0	3.539	29202	18.74	977
24	4	C	S	NO	1.00	40.2%	42.8	3.983	30892	19.06	974
26	4	C	S	NO	1.00	38.9%	41.2	4.429	32373	19.56	971
28	5.5	C	S	NO	1.00	38.5%	40.6	4.730	32928	20.34	977
30	5.5	B	T	NO	1.00	60.7%	62.5	5.125	44255	25.82	976
32	5.5	B	T	NO	1.00	60.6%	62.4	5.284	53520	22.00	975

THT-100-8T

α [°]	PN	MC	EC	VSD	SR	ηe [%]	N	[kW]	[m³/h]	[mmH₂O]	[RPM]
8	1.5	C	S	NO	1.00	50.6%	58.5	0.570	14351	7.39	738
10	1.5	C	S	NO	1.00	47.0%	54.2	0.712	15128	8.12	735
12	1.5	C	S	NO	1.00	45.3%	52.1	0.844	16290	8.62	732
14	1.5	C	S	NO	1.00	44.5%	50.9	0.975	17512	9.10	729
16	1.5	C	S	NO	1.00	42.7%	48.7	1.136	18666	9.55	726
18	1.5	C	S	NO	1.00	41.6%	47.3	1.297	19811	10.02	723
20	1.5	C	S	NO	1.00	41.0%	46.3	1.460	20942	10.50	719
22	1.5	C	S	NO	1.00	38.7%	43.6	1.677	22132	10.76	715
24	1.5	C	S	NO	1.00	37.0%	41.6	1.887	23413	10.95	710
26	2.2	C	S	NO	1.00	36.7%	41.0	2.046	24535	11.24	724
28	2.2	C	S	NO	1.00	35.8%	39.9	2.217	24956	11.68	721
30	2.2	B	T	NO	1.00	56.4%	60.3	2.403	33541	14.83	719
32	2.2	B	T	NO	1.00	56.3%	60.2	2.477	40562	12.63	718

THT-125-4T/3

α [°]	PN	MC	EC	VSD	SR	ηe [%]	N	[kW]	[m³/h]	[mmH₂O]	[RPM]
8	7.5	C	S	NO	1.00	51.3%	52.1	7.732	41511	35.13	1468
10	11	C	S	NO	1.00	52.6%	52.9	9.098	46792	37.56	1478
12	11	C	S	NO	1.00	53.7%	53.7	10.561	52185	39.90	1474
14	11	C	S	NO	1.01	55.1%	55.0	12.025	57655	42.19	1471
16	15	C	S	NO	1.01	54.9%	54.8	13.664	62205	44.33	1475
18	15	C	S	NO	1.01	54.3%	54.0	15.545	67316	46.06	1472
20	18.5	C	S	NO	1.01	54.4%	54.0	17.323	72427	47.79	1474
22	18.5	C	S	NO	1.01	52.2%	51.7	19.993	77315	49.54	1470
24	22	C	S	NO	1.01	50.6%	50.1	22.394	82218	50.63	1472
26	30	C	S	NO	1.01	51.1%	50.5	24.524	84773	54.27	1485
28	30	C	S	NO	1.01	47.9%	47.2	27.084	90252	52.81	1483
30	30	C	S	NO	1.01	46.0%	45.2	29.766	94744	53.05	1482
32	30	C	S	NO	1.01	44.1%	43.3	32.197	96187	54.28	1480
34	37	C	S	NO	1.01	41.5%	40.6	35.389	105433	51.16	1482
36	37	B	T	NO	1.01	72.5%	71.6	39.195	121252	86.13	1480
38	45	B	T	NO	1.01	72.3%	71.2	42.145	125685	89.03	1478

Erp. BEP (best efficiency point) characteristics
THT-125-4T/6

α [°]	PN	MC	EC	VSD	SR	ηe [%]	N	[kW]	[m³/h]	[mmH₂O]	[RPM]
8	11	C	S	NO	1.01	56.8%	56.8	12.019	48508	51.71	1471
10	15	C	S	NO	1.01	56.0%	55.8	14.423	52757	56.25	1474
12	18.5	C	S	NO	1.01	56.5%	56.2	16.578	58230	59.12	1475
14	18.5	C	S	NO	1.01	57.1%	56.7	18.813	63848	61.84	1472
16	22	C	S	NO	1.01	56.4%	55.9	21.703	68837	65.30	1473
18	30	C	S	NO	1.01	56.1%	55.5	24.370	77896	64.43	1485
20	30	C	S	NO	1.01	56.3%	55.6	27.347	80997	69.77	1483
22	30	C	S	NO	1.01	54.5%	53.7	30.990	85910	72.17	1481
24	37	C	S	NO	1.01	53.6%	52.7	34.666	88480	77.19	1483
26	37	C	S	NO	1.01	52.1%	51.1	38.796	93638	79.23	1481
28	45	C	S	NO	1.01	49.6%	48.5	44.005	102038	78.56	1477
30	55	C	S	NO	1.01	46.8%	45.7	48.644	106474	78.56	1479
32	55	C	S	NO	1.01	44.4%	43.1	53.455	110911	78.56	1477
34	55	C	S	NO	1.01	42.1%	40.8	58.161	116500	77.12	1475
36	75	B	T	NO	1.01	70.2%	68.8	64.063	136742	120.78	1488
38	75	B	T	NO	1.01	70.2%	68.8	69.029	142272	125.19	1487

THT-125-4T/9

α [°]	PN	MC	EC	VSD	SR	ηe [%]	N	[kW]	[m³/h]	[mmH₂O]	[RPM]
8	18.5	C	S	NO	1.01	69.3%	68.9	17.720	37304	120.90	1474
10	18.5	C	S	NO	1.01	59.8%	59.4	19.295	56423	75.15	1471
12	22	C	S	NO	1.01	57.1%	56.6	21.805	61289	74.68	1473
14	22	C	S	NO	1.01	55.7%	55.1	23.707	73859	65.67	1470
16	30	C	S	NO	1.01	53.2%	52.5	28.561	80439	69.38	1482
18	37	C	S	NO	1.01	52.2%	51.4	33.442	87528	73.29	1483
20	37	C	S	NO	1.01	51.7%	50.8	38.503	94456	77.46	1481
22	45	C	S	NO	1.01	50.6%	49.6	43.142	97688	82.16	1478
24	45	C	S	NO	1.01	50.1%	48.9	47.794	101406	86.68	1475
26	55	C	S	NO	1.01	50.6%	49.4	52.342	106241	91.67	1478
28	55	C	S	NO	1.01	49.4%	48.1	58.152	112236	93.94	1475
30	75	C	S	NO	1.01	49.3%	47.9	63.649	120361	95.67	1488
32	75	C	S	NO	1.01	48.2%	46.8	69.211	125253	97.81	1487
34	75	C	S	NO	1.01	45.7%	44.2	75.996	130939	97.53	1486
36	90	B	T	NO	1.01	72.4%	70.8	83.094	145177	152.12	1487
38	90	B	T	NO	1.02	70.2%	68.6	90.538	149120	156.66	1486

THT-125-6T/3

α [°]	PN	MC	EC	VSD	SR	ηe [%]	N	[kW]	[m³/h]	[mmH₂O]	[RPM]
8	3	C	S	NO	1.00	49.0%	53.1	2.278	27197	15.08	981
10	3	C	S	NO	1.00	49.6%	53.2	2.715	30657	16.12	977
12	3	C	S	NO	1.00	50.6%	53.8	3.152	34190	17.13	973
14	4	C	S	NO	1.00	52.7%	55.6	3.531	37774	18.11	977
16	4	C	S	NO	1.00	52.1%	54.6	4.051	40755	19.03	974
18	4	C	S	NO	1.00	51.5%	53.7	4.608	44104	19.77	970
20	5.5	C	S	NO	1.00	52.0%	53.9	5.092	47452	20.51	976
22	5.5	C	S	NO	1.00	49.9%	51.4	5.877	50654	21.27	972
24	7.5	C	S	NO	1.00	49.7%	50.9	6.486	53010	22.32	977
26	7.5	C	S	NO	1.00	48.9%	49.8	7.224	56526	22.97	974
28	7.5	C	S	NO	1.00	46.3%	46.9	7.973	59317	22.84	972
30	11	C	S	NO	1.00	44.7%	45.1	8.615	62074	22.77	979
32	11	C	S	NO	1.00	43.0%	43.2	9.358	64946	22.76	977
34	11	C	S	NO	1.00	40.2%	40.2	10.268	68214	22.21	975
36	11	B	T	NO	1.00	70.1%	70.1	11.398	79441	36.97	972
38	15	B	T	NO	1.00	70.1%	70.0	12.217	82345	38.21	974

THT CJTHT/PLUS CJTHT CJTHT/DUPLEX/ATEX



Erp. BEP (best efficiency point) characteristics

THT-125-6T/6

α [°]	PN	MC	EC	VSD	SR	ηe [%]	N	[kW]	[m³/h]	[mmH₂O]	[RPM]
8	4	C	S	NO	1.00	54.4%	57.3	3.530	31781	22.20	977
10	4	C	S	NO	1.00	53.1%	55.5	4.276	34565	24.14	972
12	5.5	C	S	NO	1.00	54.1%	56.1	4.873	38151	25.38	977
14	5.5	C	S	NO	1.00	54.7%	56.3	5.530	41832	26.55	974
16	7.5	C	S	NO	1.00	54.6%	55.8	6.307	45100	28.03	978
18	7.5	C	S	NO	1.00	53.8%	54.8	7.137	51036	27.66	975
20	7.5	C	S	NO	1.00	54.0%	54.6	8.009	53067	29.95	972
22	11	C	S	NO	1.00	52.9%	53.2	8.969	56286	30.98	978
24	11	C	S	NO	1.00	51.5%	51.6	10.146	57719	33.26	975
26	11	C	S	NO	1.00	50.3%	50.3	11.282	61349	34.01	972
28	15	C	S	NO	1.00	48.1%	48.0	12.756	66852	33.72	973
30	15	C	S	NO	1.00	45.2%	45.0	14.156	69759	33.72	970
32	15	C	S	NO	1.00	42.9%	42.6	15.556	72666	33.72	967
34	18.5	C	S	NO	1.00	40.9%	40.6	16.829	76327	33.10	979
36	18.5	B	T	NO	1.01	67.8%	67.4	18.637	89589	51.84	977
38	18.5	B	T	NO	1.01	67.9%	67.4	20.081	93213	53.74	975

THT-125-6T/9

α [°]	PN	MC	EC	VSD	SR	ηe [%]	N	[kW]	[m³/h]	[mmH₂O]	[RPM]
8	5.5	C	S	NO	1.01	66.3%	68.1	5.209	24441	51.89	975
10	5.5	C	S	NO	1.00	57.2%	58.8	5.672	36967	32.26	973
12	7.5	C	S	NO	1.00	55.3%	56.6	6.337	40155	32.06	978
14	7.5	C	S	NO	1.00	53.9%	54.9	6.890	48390	28.19	976
16	7.5	C	S	NO	1.00	51.1%	51.6	8.364	52702	29.78	970
18	11	C	S	NO	1.00	50.5%	50.6	9.725	57346	31.46	976
20	11	C	S	NO	1.00	50.0%	50.0	11.197	61885	33.25	973
22	15	C	S	NO	1.00	49.1%	49.0	12.506	64003	35.27	974
24	15	C	S	NO	1.00	48.9%	48.7	13.845	65542	37.94	971
26	15	C	S	NO	1.01	48.9%	48.7	15.232	69606	39.35	968
28	18.5	C	S	NO	1.01	48.0%	47.6	16.827	73534	40.32	979
30	18.5	C	S	NO	1.01	47.6%	47.2	18.516	78857	41.07	977
32	18.5	C	S	NO	1.01	46.6%	46.1	20.134	82062	41.98	975
34	22	C	S	NO	1.01	44.6%	44.1	21.901	85787	41.86	977
36	30	B	T	NO	1.01	70.8%	70.2	23.874	95116	65.30	989
38	30	B	T	NO	1.01	68.8%	68.1	26.013	97699	67.25	988

THT-140-6T/3

α [°]	PN	MC	EC	VSD	SR	ηe [%]	N	[kW]	[m³/h]	[mmH₂O]	[RPM]
8	4	C	S	NO	1.00	44.1%	46.7	3.951	36390	17.60	975
10	5.5	C	S	NO	1.00	45.3%	47.4	4.642	41020	18.81	978
12	5.5	C	S	NO	1.00	46.2%	47.9	5.388	45747	19.99	974
14	5.5	C	S	NO	1.00	47.4%	48.8	6.135	50542	21.13	971
16	7.5	C	S	NO	1.00	47.6%	48.6	6.925	54531	22.20	975
18	7.5	C	S	NO	1.00	47.0%	47.7	7.878	59012	23.07	972
20	11	C	S	NO	1.00	47.4%	47.8	8.727	63492	23.94	979
22	11	C	S	NO	1.00	44.8%	44.8	10.080	68187	24.30	975
24	11	C	S	NO	1.00	43.9%	43.9	11.302	71105	25.65	972
26	15	C	S	NO	1.00	43.8%	43.7	12.415	74264	26.91	974
28	15	C	S	NO	1.00	41.5%	41.3	13.688	77986	26.76	971
30	15	C	S	NO	1.00	39.9%	39.7	15.028	82755	26.65	968
32	15	B	T	NO	1.00	65.8%	65.5	16.601	99158	40.47	965
34	18.5	B	T	NO	1.00	63.5%	63.1	18.158	101655	41.68	978
36	18.5	B	T	NO	1.00	62.1%	61.7	19.821	106107	42.63	976
38	22	B	T	NO	1.00	62.2%	61.7	21.201	110043	44.01	978

**Erp. BEP (best efficiency point) characteristics****THT-140-6T/6**

α [°]	PN	MC	EC	VSD	SR	ηe [%]	N	[kW]	[m³/h]	[mmH ₂ O]	[RPM]
8	5.5	C	S	NO	1.00	48.9%	50.3	6.132	42524	25.90	971
10	7.5	C	S	NO	1.00	48.5%	49.4	7.310	46249	28.17	974
12	7.5	C	S	NO	1.00	48.7%	49.2	8.451	51047	29.61	970
14	11	C	S	NO	1.00	49.8%	50.0	9.478	55972	30.98	977
16	11	C	S	NO	1.00	48.9%	48.9	10.985	60345	32.71	973
18	15	C	S	NO	1.00	48.6%	48.5	12.339	68287	32.27	974
20	15	C	S	NO	1.00	48.8%	48.6	13.847	71005	34.95	971
22	15	C	S	NO	1.00	47.2%	47.0	15.691	75312	36.15	967
24	18.5	C	S	NO	1.00	45.6%	45.2	17.766	80549	36.94	978
26	18.5	C	S	NO	1.01	44.7%	44.2	19.692	84172	38.41	976
28	22	C	S	NO	1.01	43.3%	42.7	22.143	89450	39.35	977
30	30	C	S	NO	1.01	40.9%	40.3	24.432	93339	39.35	989
32	30	B	T	NO	1.01	61.6%	60.9	27.111	110368	55.55	987
34	30	B	T	NO	1.01	60.7%	59.9	29.742	114996	57.67	986
36	30	B	T	NO	1.01	60.3%	59.5	32.339	119625	59.87	985
38	37	B	T	NO	1.01	60.6%	59.7	34.669	124508	61.99	983

THT-140-6T/9

α [°]	PN	MC	EC	VSD	SR	ηe [%]	N	[kW]	[m³/h]	[mmH ₂ O]	[RPM]
8	11	C	S	NO	1.01	60.4%	60.7	8.928	32703	60.56	978
10	11	C	S	NO	1.00	52.1%	52.2	9.721	49463	37.64	976
12	11	C	S	NO	1.00	49.6%	49.6	11.037	53728	37.41	973
14	11	C	S	NO	1.00	48.3%	48.3	11.999	64747	32.90	971
16	15	C	S	NO	1.00	46.1%	45.9	14.461	70516	34.75	970
18	18.5	C	S	NO	1.00	45.3%	45.0	16.917	76730	36.71	979
20	18.5	C	S	NO	1.01	44.9%	44.5	19.477	82804	38.80	976
22	22	C	S	NO	1.01	44.2%	43.7	21.709	85637	41.15	977
24	30	C	S	NO	1.01	43.9%	43.3	23.911	88897	43.42	989
26	30	C	S	NO	1.01	44.3%	43.6	26.289	93135	45.91	988
28	30	C	S	NO	1.01	43.7%	42.9	29.250	100645	46.65	987
30	30	C	S	NO	1.01	42.7%	41.9	32.140	105521	47.79	985
32	37	B	T	NO	1.01	65.7%	64.9	34.831	119380	70.46	983
34	37	B	T	NO	1.01	64.1%	63.1	38.467	123186	73.50	981
36	45	B	T	NO	1.01	62.7%	61.6	41.676	127100	75.48	987
38	45	B	T	NO	1.01	60.8%	59.7	45.403	130545	77.70	986

THT-140-8T/3

α [°]	PN	MC	EC	VSD	SR	ηe [%]	N	[kW]	[m³/h]	[mmH ₂ O]	[RPM]
8	3	C	S	NO	1.00	42.1%	46.8	1.804	27580	10.11	730
10	3	C	S	NO	1.00	42.6%	46.8	2.149	31089	10.81	726
12	3	C	S	NO	1.00	43.4%	47.3	2.495	34672	11.48	723
14	3	C	S	NO	1.00	44.6%	48.0	2.841	38306	12.14	719
16	3	C	S	NO	1.00	44.0%	47.1	3.258	41329	12.75	714
18	4	C	S	NO	1.00	45.1%	48.0	3.576	44725	13.25	735
20	4	C	S	NO	1.00	44.9%	47.5	4.009	48120	13.75	733
22	4	C	S	NO	1.00	43.1%	45.2	4.625	51261	14.28	730
24	5.5	C	S	NO	1.00	42.4%	44.3	5.159	53756	14.96	734
26	5.5	C	S	NO	1.00	41.9%	43.5	5.712	56323	15.62	732
28	5.5	C	S	NO	1.00	39.7%	40.9	6.308	59552	15.43	730
30	7.5	C	S	NO	1.00	38.5%	39.5	6.794	62720	15.31	730
32	7.5	B	T	NO	1.00	63.4%	64.2	7.505	75151	23.24	728
34	7.5	B	T	NO	1.00	60.8%	61.4	8.256	77044	23.94	726
36	11	B	T	NO	1.00	60.2%	60.5	8.910	80418	24.49	732
38	11	B	T	NO	1.00	59.7%	59.8	9.620	83401	25.28	731

THT CJTHT/PLUS CJTHT CJTHT/DUPLEX/ATEX



Erp. BEP (best efficiency point) characteristics

THT-140-8T/6

α [°]	PN	MC	EC	VSD	SR	ηe [%]	N	[kW]	[m³/h]	[mmH₂O]	[RPM]
8	3	C	S	NO	1.00	46.0%	49.4	2.839	32229	14.88	719
10	3	C	S	NO	1.00	44.9%	47.8	3.440	35052	16.18	712
12	4	C	S	NO	1.00	46.7%	49.3	3.837	38688	17.01	734
14	4	C	S	NO	1.00	47.2%	49.5	4.354	42421	17.79	731
16	5.5	C	S	NO	1.00	46.6%	48.5	5.017	45735	18.79	734
18	5.5	C	S	NO	1.00	46.0%	47.6	5.677	51754	18.54	732
20	5.5	C	S	NO	1.00	46.2%	47.4	6.370	53815	20.07	730
22	7.5	C	S	NO	1.00	45.5%	46.4	7.094	57078	20.77	729
24	7.5	C	S	NO	1.00	44.1%	44.7	8.060	58997	22.14	727
26	11	C	S	NO	1.00	43.8%	44.1	8.822	62213	22.80	732
28	11	C	S	NO	1.00	41.5%	41.6	10.048	67794	22.60	730
30	11	C	S	NO	1.00	39.0%	39.0	11.151	70741	22.60	728
32	11	B	T	NO	1.00	58.7%	58.6	12.374	83648	31.91	725
34	15	B	T	NO	1.00	59.2%	59.1	13.273	87155	33.13	734
36	15	B	T	NO	1.00	58.8%	58.6	14.432	90663	34.39	733
38	15	B	T	NO	1.00	58.8%	58.6	15.548	94364	35.61	731

THT-140-8T/9

α [°]	PN	MC	EC	VSD	SR	ηe [%]	N	[kW]	[m³/h]	[mmH₂O]	[RPM]
8	4	C	S	NO	1.00	57.2%	59.7	4.101	24785	34.78	733
10	4	C	S	NO	1.00	49.4%	51.6	4.465	37487	21.62	731
12	5.5	C	S	NO	1.00	47.3%	49.2	5.040	40720	21.49	734
14	5.5	C	S	NO	1.00	46.1%	47.7	5.480	49072	18.90	733
16	7.5	C	S	NO	1.00	44.4%	45.6	6.538	53444	19.96	731
18	7.5	C	S	NO	1.00	43.4%	44.1	7.692	58154	21.09	728
20	11	C	S	NO	1.00	43.5%	43.9	8.755	62756	22.29	732
22	11	C	S	NO	1.00	42.4%	42.5	9.851	64904	23.64	730
24	11	C	S	NO	1.00	42.2%	42.2	10.906	66465	25.43	728
26	11	C	S	NO	1.00	42.2%	42.2	11.998	70586	26.37	726
28	15	C	S	NO	1.00	42.1%	42.0	13.034	74569	27.03	734
30	15	C	S	NO	1.00	41.8%	41.6	14.343	79968	27.53	733
32	15	B	T	NO	1.00	63.8%	63.6	15.621	90477	40.47	731
34	18.5	B	T	NO	1.00	63.4%	63.0	16.932	93362	42.22	733
36	18.5	B	T	NO	1.00	61.7%	61.3	18.430	96329	43.35	732
38	18.5	B	T	NO	1.00	59.9%	59.4	20.078	98939	44.63	730

THT-160-6T/3

α [°]	PN	MC	EC	VSD	SR	ηe [%]	N	[kW]	[m³/h]	[mmH₂O]	[RPM]
8	7.5	C	S	NO	1.00	45.5%	46.3	7.473	54320	22.98	974
10	11	C	S	NO	1.00	46.5%	46.9	8.801	61231	24.57	978
12	11	C	S	NO	1.00	47.5%	47.6	10.216	68287	26.10	975
14	11	C	S	NO	1.00	48.7%	48.7	11.632	75445	27.60	972
16	15	C	S	NO	1.00	48.5%	48.4	13.244	81399	29.00	972
18	15	C	S	NO	1.00	48.0%	47.7	15.068	88088	30.14	968
20	18.5	C	S	NO	1.00	48.0%	47.7	16.795	94775	31.26	979
22	18.5	C	S	NO	1.00	46.1%	45.6	19.377	100960	32.47	976
24	22	C	S	NO	1.00	45.5%	45.0	21.535	105875	34.02	978
26	22	C	S	NO	1.00	45.0%	44.4	23.846	110931	35.51	975
28	30	C	S	NO	1.00	42.8%	42.1	26.180	117291	35.09	988
30	30	C	S	NO	1.01	40.8%	40.1	28.693	123530	34.81	987
32	30	B	T	NO	1.01	67.2%	66.4	31.697	148014	52.85	985
34	37	B	T	NO	1.01	64.8%	63.9	34.696	151742	54.44	983
36	37	B	T	NO	1.01	63.4%	62.4	37.874	158387	55.68	981
38	45	B	T	NO	1.01	63.2%	62.1	40.703	164263	57.49	987

Erp. BEP (best efficiency point) characteristics
THT-160-6T/6

α [°]	PN	MC	EC	VSD	SR	η_e [%]	N	[kW]	[m ³ /h]	[mmH ₂ O]	[RPM]
8	11	C	S	NO	1.00	50.3%	50.3	11.626	63476	33.83	972
10	15	C	S	NO	1.00	49.5%	49.3	13.981	69036	36.80	971
12	15	C	S	NO	1.00	49.6%	49.3	16.165	76198	38.68	966
14	18.5	C	S	NO	1.00	50.4%	50.1	18.240	83550	40.46	978
16	22	C	S	NO	1.01	50.0%	49.5	20.941	90077	42.72	978
18	22	C	S	NO	1.01	49.4%	48.8	23.696	101933	42.15	975
20	30	C	S	NO	1.01	49.8%	49.1	26.438	105991	45.64	988
22	30	C	S	NO	1.01	48.2%	47.5	29.960	112419	47.22	986
24	37	C	S	NO	1.01	46.5%	45.6	33.947	120236	48.25	983
26	37	C	S	NO	1.01	45.1%	44.2	37.597	124823	49.92	981
28	45	C	S	NO	1.01	43.9%	42.9	42.513	133523	51.39	987
30	45	C	S	NO	1.01	41.1%	40.0	47.358	143764	49.76	985
32	55	B	T	NO	1.01	62.5%	61.3	52.024	164748	72.55	987
34	55	B	T	NO	1.01	61.7%	60.4	57.073	171656	75.33	985
36	75	B	T	NO	1.01	61.4%	60.1	61.857	178566	78.19	988
38	75	B	T	NO	1.01	61.5%	60.1	66.644	185855	80.97	987

THT-160-6T/9

α [°]	PN	MC	EC	VSD	SR	η_e [%]	N	[kW]	[m ³ /h]	[mmH ₂ O]	[RPM]
8	18.5	C	S	NO	1.01	61.2%	60.8	17.180	48815	79.09	979
10	18.5	C	S	NO	1.01	52.8%	52.4	18.707	73833	49.16	977
12	22	C	S	NO	1.01	50.7%	50.2	21.039	80201	48.86	978
14	22	C	S	NO	1.01	49.4%	48.9	22.875	96649	42.97	976
16	30	C	S	NO	1.01	47.1%	46.4	27.612	105260	45.39	987
18	30	C	S	NO	1.01	46.0%	45.2	32.485	114536	47.95	985
20	37	C	S	NO	1.01	45.8%	44.9	37.216	123602	50.68	981
22	45	C	S	NO	1.01	44.9%	43.9	41.679	127831	53.75	987
24	45	C	S	NO	1.01	44.3%	43.2	46.182	136572	55.04	986
26	55	C	S	NO	1.01	45.0%	43.8	50.446	139024	59.97	987
28	55	C	S	NO	1.01	44.4%	43.1	56.127	150233	60.93	986
30	75	C	S	NO	1.01	43.5%	42.2	61.477	157513	62.42	988
32	75	B	T	NO	1.01	66.7%	65.3	66.956	178199	92.03	987
34	75	B	T	NO	1.01	65.0%	63.5	73.945	183881	96.00	986
36	90	B	T	NO	1.01	63.5%	61.9	80.239	189724	98.58	987
38	90	B	T	NO	1.01	61.6%	60.0	87.415	194865	101.48	986

THT-160-8T/3

α [°]	PN	MC	EC	VSD	SR	η_e [%]	N	[kW]	[m ³ /h]	[mmH ₂ O]	[RPM]
8	3	C	S	NO	1.00	42.1%	45.0	3.517	41169	13.20	712
10	4	C	S	NO	1.00	44.1%	46.6	4.043	46407	14.12	733
12	4	C	S	NO	1.00	45.0%	47.1	4.693	51755	14.99	730
14	5.5	C	S	NO	1.00	46.5%	48.2	5.312	57179	15.86	733
16	5.5	C	S	NO	1.00	45.9%	47.3	6.093	61692	16.66	731
18	7.5	C	S	NO	1.00	46.2%	47.3	6.812	66761	17.31	730
20	7.5	C	S	NO	1.00	46.0%	46.7	7.636	71830	17.96	728
22	11	C	S	NO	1.00	44.6%	45.0	8.710	76517	18.65	733
24	11	C	S	NO	1.00	43.7%	43.8	9.772	80242	19.54	730
26	11	C	S	NO	1.00	43.0%	43.1	10.884	85565	20.11	728
28	11	C	S	NO	1.00	40.7%	40.6	12.012	89790	20.00	726
30	15	C	S	NO	1.00	39.7%	39.6	12.842	93963	19.93	735
32	15	B	T	NO	1.00	65.5%	65.4	14.145	112179	30.36	733
34	15	B	T	NO	1.00	62.9%	62.7	15.561	115004	31.27	731
36	18.5	B	T	NO	1.00	62.7%	62.4	16.671	120041	31.98	733
38	18.5	B	T	NO	1.00	62.2%	61.8	18.000	124494	33.02	732

THT CJTHT/PLUS CJTHT CJTHT/DUPLEX/ATEX



Erp. BEP (best efficiency point) characteristics

THT-160-8T/6

α [°]	PN	MC	EC	VSD	SR	ηe [%]	N	[kW]	[m³/h]	[mmH₂O]	[RPM]
8	5.5	C	S	NO	1.00	47.9%	49.7	5.309	48108	19.43	733
10	5.5	C	S	NO	1.00	46.8%	48.0	6.432	52322	21.14	730
12	7.5	C	S	NO	1.00	47.8%	48.7	7.308	57750	22.22	729
14	7.5	C	S	NO	1.00	48.3%	48.8	8.293	63322	23.24	726
16	11	C	S	NO	1.00	48.0%	48.2	9.503	68269	24.54	731
18	11	C	S	NO	1.00	47.4%	47.4	10.753	77254	24.21	728
20	11	C	S	NO	1.00	47.5%	47.5	12.067	80330	26.22	726
22	15	C	S	NO	1.00	47.1%	46.9	13.370	85202	27.12	734
24	15	C	S	NO	1.00	45.2%	45.0	15.185	90276	27.95	732
26	18.5	C	S	NO	1.00	45.9%	45.6	16.421	93251	29.67	734
28	18.5	C	S	NO	1.00	43.3%	42.8	18.800	101197	29.52	731
30	22	C	S	NO	1.00	40.8%	40.3	20.795	105597	29.52	733
32	22	B	T	NO	1.00	61.4%	60.8	23.076	124862	41.67	731
34	30	B	T	NO	1.00	60.7%	60.1	25.233	130097	43.27	734
36	30	B	T	NO	1.00	60.3%	59.6	27.435	135334	44.91	733
38	30	B	T	NO	1.00	60.3%	59.6	29.559	140858	46.51	732

THT-160-8T/9

α [°]	PN	MC	EC	VSD	SR	ηe [%]	N	[kW]	[m³/h]	[mmH₂O]	[RPM]
8	7.5	C	S	NO	1.00	58.6%	59.3	7.811	36997	45.43	727
10	7.5	C	S	NO	1.00	50.6%	51.0	8.506	55958	28.24	725
12	11	C	S	NO	1.00	48.6%	48.8	9.547	60783	28.06	731
14	11	C	S	NO	1.00	47.4%	47.5	10.380	73250	24.68	729
16	15	C	S	NO	1.00	45.9%	45.9	12.322	79776	26.07	735
18	15	C	S	NO	1.00	44.9%	44.7	14.497	86806	27.54	733
20	18.5	C	S	NO	1.00	45.3%	45.0	16.381	93677	29.11	734
22	18.5	C	S	NO	1.00	44.2%	43.8	18.431	96883	30.88	732
24	22	C	S	NO	1.00	43.8%	43.3	20.352	100570	32.57	733
26	22	C	S	NO	1.00	44.2%	43.6	22.376	105365	34.45	731
28	30	C	S	NO	1.00	43.6%	43.0	24.790	111878	35.51	735
30	30	C	S	NO	1.01	42.8%	42.1	27.267	119369	35.95	733
32	30	B	T	NO	1.01	65.4%	64.7	29.697	135056	52.86	732
34	37	B	T	NO	1.01	64.3%	63.4	32.550	139362	55.14	742
36	37	B	T	NO	1.01	62.6%	61.7	35.429	143791	56.62	741
38	37	B	T	NO	1.01	60.7%	59.7	38.598	147687	58.29	740

THT/HATCH

High-powered ventilators with motorised opening and equipped with a roof fan, for smoke extraction in the event of a fire, 400°C/2h



High-powered ventilators with roof fan and motorised opening. Specially designed to extract smoke and dangerous fumes in a quick and efficient manner in the event of a fire. Suitable for installation in industrial warehouses or commercial facilities. Approval according to Standard EN-12101-3-2002/AC:2005, with F-400 certification

Fast smoke extraction allows for an efficient intervention on behalf of the firefighters and the quick evacuation of people, while avoiding the kindling of new fires and further structural damage to the building. It may also be used for the purpose of environmental ventilation throughout the building in which it has been installed



Ventilator:

- Extremely robust structure which can withstand severe climate changes
- Equipment's structure made of anticorrosive galvanised sheet
- Designed to ensure leaktightness at the inlet for water supply
- Thermal insulation to avoid the loss of heat during the winter
- Base/plinth system to ensure a correct and simple installation on the roof

Opening system:

- Motorised opening arms, with IP-65 canned drive
- Power supply voltage of 230 V. AC 50Hz or 24V. DC
- Reinforced system, guaranteed for over 10,000 maximum load operations
- Maximum load: 1000 Nw
- Automatic opening via external control input (fire control panel, smoke detector, manual switch...) Control system not included.
- Manual opening for regulating environmental ventilation via a switch
- Limit switch in place to indicate the hatch's position

Fan:

- THT series fans, with F-400 certification No. 0370-CPD-0305
- Sheet steel tubular casing with anticorrosive finish in polyester resin.
- Turnable impellers cast aluminium.

Motor:

- Class H motors, ongoing use S1 and emergency use S2, with ball bearings and IP55 protection
- Three-phase 230/400V.-50Hz. (up to 4CV.) and 400/690V.-50Hz. (power over 4CV.)
- Max. air temperature to transport: S1 Service -20°C + 40°C for ongoing use
- 400°C/2h S2 Service

Finish:

- Anticorrosive galvanised sheet steel

On request:

- Equipped with F-300 certified fans
- Finish in anticorrosive paint with polyester resin

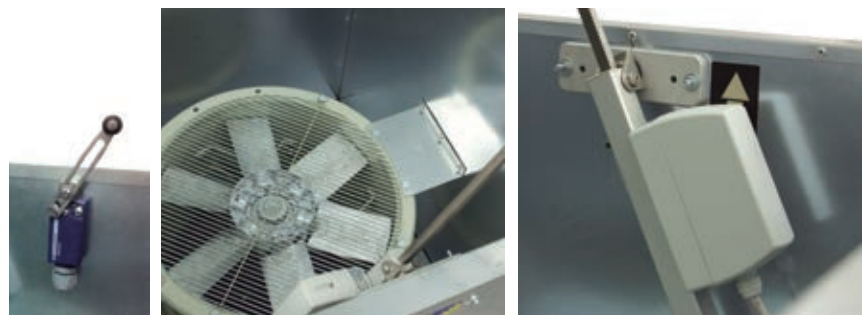

Order code

THT/HATCH	—	40	—	2T	—	1	—	N	—	1	—	G
Model		Size		Number of motor poles 2=2900 r/min. 50 Hz 4=1400 r/min. 50 Hz 6=900 r/min. 50 Hz	T=Three-phase	Power motor (c.v.)		Electrical accessories N= no accessories Y= With limit switch		Power voltage opening system 1=230 V.AC 2=24 V.DC		Finish G=galvanised P=painted a special colour

Technical characteristics

Model	Speed (r/min)	Maximum admissible current (A)			Installed power (kW)	Maximum airflow (m ³ /h)	Sound pressure level dB(A)	Weight approx. (Kg)
		230V	400V	690V				
THT/HATCH-40-2T-1	2850	3.15	1.80		0.75	6115	72	160
THT/HATCH-40-2T-1.5	2880	4.70	2.70		1.10	7050	73	164
THT/HATCH-45-2T-2	2880	5.90	3.40		1.50	9405	75	169
THT/HATCH-45-2T-3	2840	8.70	5.00		2.20	11325	77	170
THT/HATCH-50-2T-2	2880	5.90	3.40		1.50	10100	77	173
THT/HATCH-50-2T-3	2840	8.70	5.00		2.20	11925	78	175
THT/HATCH-50-2T-4	2880	11.20	6.50		3.00	13860	79	182
THT/HATCH-50-2T-5.5	2870		9.30	5.40	4.00	15900	80	198
THT/HATCH-56-2T-5.5	2870		9.50	5.50	4.00	18840	85	202
THT/HATCH-56-2T-7.5	2910		10.60	6.14	5.50	22510	86	213
THT/HATCH-56-4T-2	1440	6.20	3.60		1.50	15020	72	181
THT/HATCH-63-4T-3	1425	9.00	5.20		2.20	22460	73	232
THT/HATCH-63-4T-4	1430	11.40	6.60		3.00	24460	74	241
THT/HATCH-63-6T-1	940	4.70	2.70		0.75	16025	63	222
THT/HATCH-80-4T-3	1425	9.00	5.20		2.20	25545	79	250
THT/HATCH-80-4T-4	1430	11.40	6.60		3.00	30410	80	259
THT/HATCH-80-4T-5.5	1440		8.40	4.80	4.00	32940	81	265
THT/HATCH-80-4T-7.5	1460		12.60	7.30	5.50	39820	82	281
THT/HATCH-80-6T-1.5	945	5.50	3.20		1.10	21580	69	249
THT/HATCH-80-6T-2	945	7.40	4.30		1.50	26090	70	258
THT/HATCH-90-4T-7.5	1460		12.60	7.30	5.50	46325	88	356
THT/HATCH-90-4T-10	1460		17.70	10.20	7.50	50315	89	367
THT/HATCH-90-4T-15	1460		22.00	12.70	11.00	59610	90	420
THT/HATCH-90-6T-3	950	9.50	5.50		2.20	34055	75	329
THT/HATCH-90-6T-4	970	13.50	7.80		3.00	39055	76	355
THT/HATCH-100-4T-10	1460		17.70	10.20	7.50	57650	90	376
THT/HATCH-100-4T-15	1460		22.00	12.70	11.00	66505	91	429
THT/HATCH-100-4T-20	1460		29.00	16.70	15.00	76445	92	444
THT/HATCH-100-6T-5.5	970		11.00	6.40	4.00	47955	81	376
THT/HATCH-100-6T-7.5	970		12.40	7.20	5.50	53545	82	383

Technical characteristics of the high-powered ventilators according to standard EN-12101-3-2002/AC:2005

Model	Officially approved °C	Class insulation for motor	Durability	Minimum environmental temperature	Wind load (Pa)	Snow load (Pa)
THT/HATCH	F-400	H Class	RE 10000	T(-15)	WL 1500	SL 500



Erp. BEP (best efficiency point) characteristics

<(°)	Angle of inclination of the blades, in degrees	SR	Specific ratio
PN	Motor's nominal power in kW	ηe[%]	Efficiency
MC	Measurement category	N	Efficiency grade
EC	Efficiency category	[kW]	Input power
S	Static	[m³/h]	Airflow
T	Total	[mmH²O]	Static or total pressure (According to EC)
VSD	Variable-speed drive	[RPM]	Speed

Model	<(°)	PN	MC	EC	VSD	SR	ηe[%]	N	(kW)	(m³/h)	(mmH²O)	(RPM)
THT/HATCH-40-2T-1	16	0.75	A	S	NO	1.00	41.5%	48.1	0.933	4420	32.19	2850
THT/HATCH-40-2T-1.5	20	1.1	A	S	NO	1.00	33.6%	38.9	1.445	5180	34.43	2884
THT/HATCH-45-2T-2	16	1.5	A	S	NO	1.00	35.9%	40.8	1.688	6802	32.70	2896
THT/HATCH-45-2T-3	22	2.2	A	S	NO	1.01	37.7%	41.6	2.405	8144	40.86	2854
THT/HATCH-50-2T-2	8	1.5	A	S	NO	1.00	35.9%	40.3	2.014	6731	39.48	2876
THT/HATCH-50-2T-3	12	2.2	A	S	NO	1.01	36.8%	40.5	2.586	7884	44.29	2843
THT/HATCH-50-2T-4	16	3	A	S	NO	1.01	34.3%	37.3	3.381	8962	47.55	2885
THT/HATCH-50-2T-5.5	20	4	A	S	NO	1.01	32.6%	35.1	4.131	9537	51.91	2885
THT/HATCH-56-2T-5.5	16	4	A	S	NO	1.01	45.4%	47.8	4.202	12896	54.34	2883
THT/HATCH-56-2T-7.5	22	5.5	A	S	NO	1.01	41.2%	42.6	6.055	15917	57.53	2913
THT/HATCH-56-4T-2	36	1.5	B	T	NO	1.00	45.7%	50.7	1.665	13581	20.60	1445
THT/HATCH-63-4T-3	32	2.2	B	T	NO	1.00	62.0%	65.9	2.443	20324	27.38	1430
THT/HATCH-63-4T-4	38	3	B	T	NO	1.00	57.8%	60.9	3.270	24239	28.64	1440
THT/HATCH-63-6T-1	38	0.75	B	T	NO	1.00	48.4%	54.4	1.099	15880	12.29	942
THT/HATCH-80-4T-3	12	2.2	C	S	NO	1.00	47.1%	51.0	2.413	16923	24.69	1430
THT/HATCH-80-4T-4	16	3	C	S	NO	1.00	41.1%	43.8	3.686	20444	27.19	1432
THT/HATCH-80-4T-5.5	18	4	C	S	NO	1.00	41.2%	43.5	4.246	22304	28.78	1448
THT/HATCH-80-4T-7.5	26	5.5	B	T	NO	1.00	63.0%	64.5	5.914	35186	38.92	1465
THT/HATCH-80-6T-1.5	18	1.1	C	S	NO	1.00	35.4%	40.8	1.389	14613	12.35	951
THT/HATCH-80-6T-2	26	1.5	B	T	NO	1.00	57.5%	62.1	1.825	23053	16.71	950
THT/HATCH-90-4T-7.5	18	5.5	C	S	NO	1.00	44.1%	45.2	6.749	31521	34.72	1460
THT/HATCH-90-4T-10	22	7.5	C	S	NO	1.01	38.9%	39.2	9.154	35009	37.36	1463
THT/HATCH-90-4T-15	30	11	B	T	NO	1.01	67.1%	67.1	11.526	52205	54.45	1463
THT/HATCH-90-6T-3	24	2.2	C	S	NO	1.00	38.0%	41.5	2.832	23831	16.58	950
THT/HATCH-90-6T-4	30	3	B	T	NO	1.00	58.8%	61.6	3.698	34203	23.37	971
THT/HATCH-100-4T-10	16	7.5	C	S	NO	1.00	41.3%	41.4	9.606	37591	38.73	1461
THT/HATCH-100-4T-15	22	11	C	S	NO	1.01	43.6%	43.5	12.145	44571	43.65	1461
THT/HATCH-100-4T-20	28	15	B	T	NO	1.01	64.1%	63.8	16.091	66559	56.95	1462
THT/HATCH-100-6T-5.5	26	4	B	T	NO	1.00	57.6%	59.7	4.671	42042	23.50	973
THT/HATCH-100-6T-7.5	32	5.5	B	T	NO	1.00	56.3%	57.9	5.690	53520	22.00	975

Acoustic features

The specified values are determined according to free field measurements of sound levels in dB(A) at an equivalent distance of twice the fan's span plus the impeller's diameter, with a minimum of 1.5 m.

Sound power Lw(A) spectrum in dB(A) via frequency band in Hz.

Model	63	125	250	500	1000	2000	4000	8000	Model	63	125	250	500	1000	2000	4000	8000
40-2-1	44	65	72	77	80	76	69	58	80-4-4	54	74	82	87	89	86	79	71
40-2-1,5	45	66	73	78	81	77	70	59	80-4-5,5	54	74	82	87	89	86	79	72
45-2-2	47	68	75	80	83	79	72	61	80-4-7,5	55	75	83	88	90	87	80	73
45-2-3	49	70	77	82	85	81	74	63	80-6-1,5	47	64	72	77	79	76	69	58
50-2-2	52	72	80	85	87	84	77	66	80-6-2	48	65	73	78	80	77	70	59
50-2-3	53	73	81	86	88	85	78	67	90-4-7,5	57	78	85	90	93	89	82	71
50-2-4	54	74	82	87	89	86	79	68	90-4-10	56	77	84	89	92	88	81	70
50-2-5,5	55	75	83	88	90	87	80	69	90-4-15	58	79	86	91	94	90	83	72
56-2-5,5	60	80	88	93	95	92	85	74	90-6-3	54	68	75	80	83	79	72	61
56-2-7,5	61	81	89	94	96	93	86	75	90-6-4	55	70	77	82	85	81	74	63
56-4-2	47	67	75	80	82	79	72	61	100-4-10	60	80	88	93	95	92	85	74
63-4-3	50	68	76	81	83	80	75	64	100-4-15	59	79	87	92	94	91	84	73
63-4-4	51	69	77	82	84	81	76	65	100-4-20	61	81	89	94	96	93	86	75
63-6-1	41	60	68	73	75	72	65	55	100-6-5,5	62	71	79	84	86	83	76	65
80-4-3	56	75	83	89	90	87	81	70	100-6-7,5	63	72	80	85	87	84	77	66

Dimensions in mm

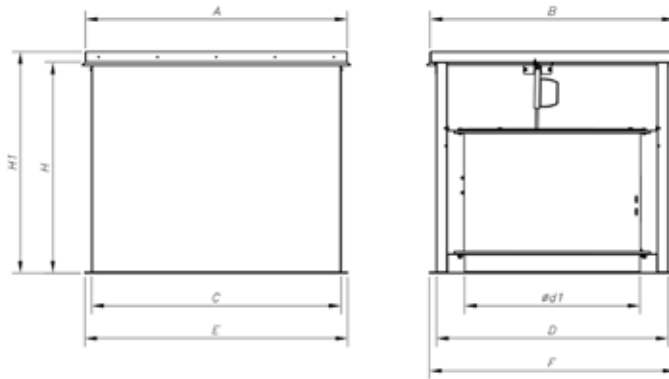

Model	A	B	C	D	ød1	E	F	H	H1
THT/HATCH-40-2T-1	1100	990	1022	920	400	1100	1000	1200	1260
THT/HATCH-40-2T-1'5	1100	990	1022	920	400	1100	1000	1200	1260
THT/HATCH-45-2T-2	1100	990	1022	920	450	1100	1000	1200	1260
THT/HATCH-45-2T-3	1100	990	1022	920	450	1100	1000	1200	1260
THT/HATCH-50-2T-2	1100	990	1022	920	500	1100	1000	1200	1260
THT/HATCH-50-2T-3	1100	990	1022	920	500	1100	1000	1200	1260
THT/HATCH-50-2T-4	1100	990	1022	920	500	1100	1000	1200	1260
THT/HATCH-50-2T-5'5	1100	990	1022	920	500	1100	1000	1200	1260
THT/HATCH-56-2T-5'5	1100	990	1022	920	560	1100	1000	1200	1260
THT/HATCH-56-2T-7'5	1100	990	1022	920	560	1100	1000	1200	1260
THT/HATCH-56-4T-2	1100	990	1022	920	560	1100	1000	1200	1260
THT/HATCH-63-4T-3	1295	1195	1222	1122	630	1300	1200	1200	1260
THT/HATCH-63-4T-4	1295	1195	1222	1122	630	1300	1200	1200	1260
THT/HATCH-63-6T-1	1295	1195	1222	1122	630	1300	1200	1200	1260
THT/HATCH-80-4T-3	1295	1195	1222	1122	800	1300	1200	1200	1260

Model	A	B	C	D	ød1	E	F	H	H1
THT/HATCH-80-4T-4	1295	1195	1222	1122	800	1300	1200	1200	1260
THT/HATCH-80-4T-5'5	1295	1195	1222	1122	800	1300	1200	1200	1260
THT/HATCH-80-4T-7'5	1295	1195	1222	1122	800	1300	1200	1200	1260
THT/HATCH-80-6T-1'5	1295	1195	1222	1122	800	1300	1200	1200	1260
THT/HATCH-80-6T-2	1295	1195	1222	1122	800	1300	1200	1200	1260
THT/HATCH-80-4T-7'5	1492	1392	1420	1320	900	1500	1400	1200	1260
THT/HATCH-90-4T-10	1492	1392	1420	1320	900	1500	1400	1200	1260
THT/HATCH-90-4T-15	1492	1392	1420	1320	900	1500	1400	1200	1260
THT/HATCH-90-6T-3	1492	1392	1420	1320	900	1500	1400	1200	1260
THT/HATCH-90-6T-4	1492	1392	1420	1320	900	1500	1400	1200	1260
THT/HATCH-100-4T-10	1492	1392	1420	1320	1000	1500	1400	1200	1260
THT/HATCH-100-4T-15	1492	1392	1420	1320	1000	1500	1400	1200	1260
THT/HATCH-100-4T-20	1492	1392	1420	1320	1000	1500	1400	1200	1260
THT/HATCH-100-6T-5'5	1492	1392	1420	1320	1000	1500	1400	1200	1260
THT/HATCH-100-6T-7'5	1492	1392	1420	1320	1000	1500	1400	1200	1260

Installation diagram

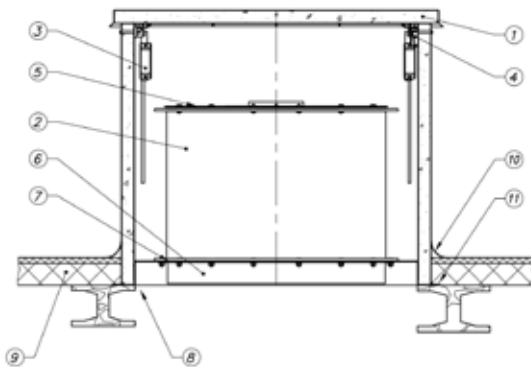

1. THT/HATCH high-powered ventilators
2. THT fan
3. Motorised arms (230V AC or 24V DC x2)
4. Limit switch
5. Protection guard for outlet
6. Connection flange for inlet duct
7. Protection guard for inlet (optional)
8. Roof opening
9. Roofing
10. Leak protection
11. Direct mounting using base/plinth adaptation system

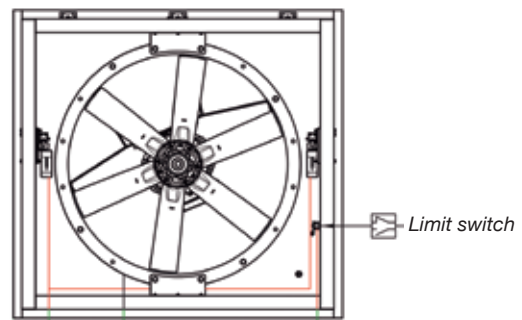

Actuator power source
1x230V 50Hz
or 24 VDC

Motor power source
3x400V 50Hz

Limit switch connection

— Pre-installation supplied by the manufacturer
 - - - To be carried out by the installation technician

Note: The use of electronic starters is recommended for motors of over 5.5kW

Characteristic curves

Q = Airflow in m³/h, m³/s and cfm.

Pe = Static pressure in mmH₂O, Pa and inwg.

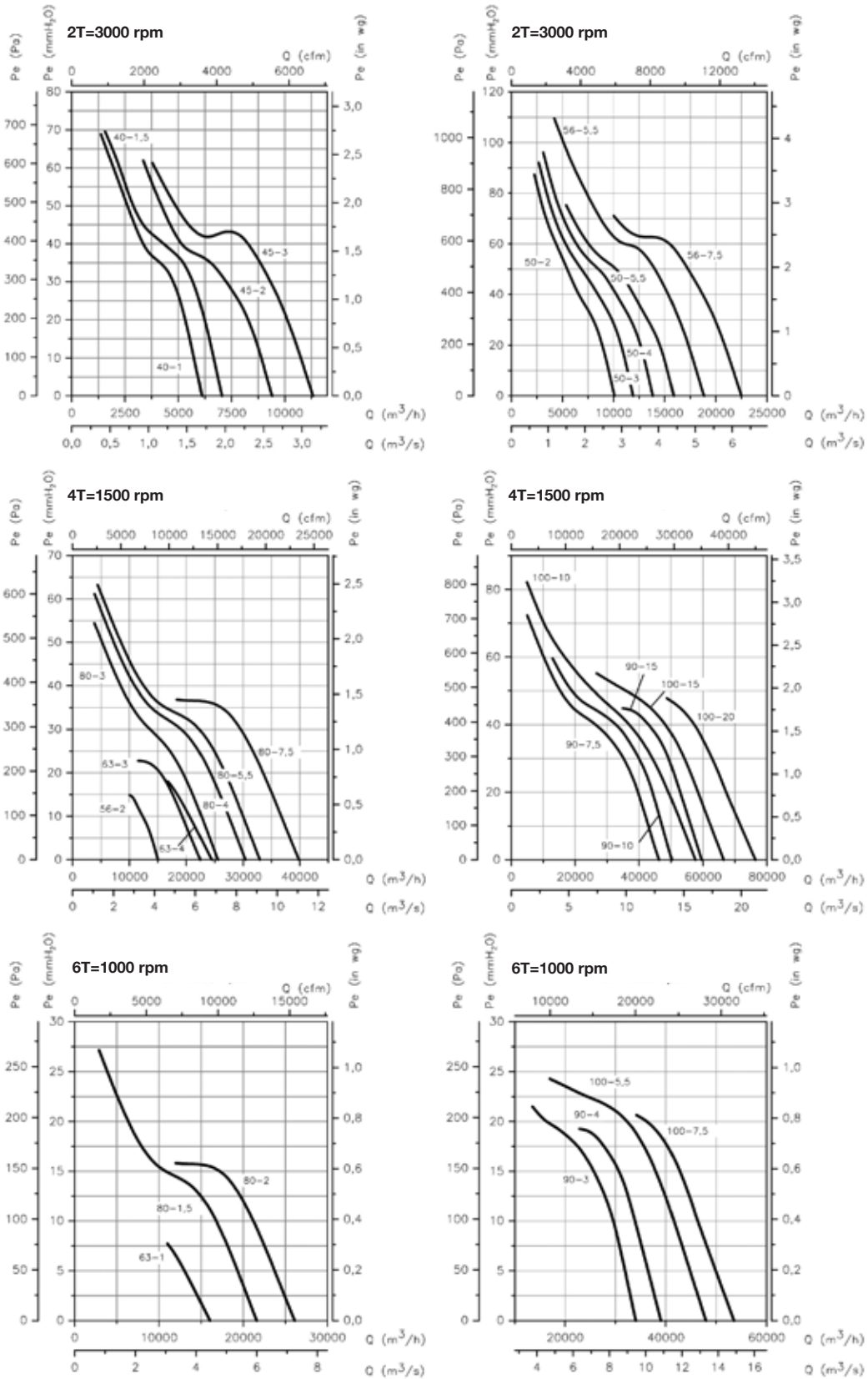

THT/IMP

400°C/2h, 300°C/2h and 200°C/2h single-direction or reversible long-range impulsion fans



THT/IMP-C



THT/IMP-O



THT/IMP-L

200°C/2h, 300°C/2h and 400°C/2h single-direction or reversible long-range impulsion fans with circular, (THT/IMP-C), octagonal (THT/IMP-L) or painted octagonal (THT/IMP-O) design

Fan:

- Single-direction or reversible ventilation unit consisting of a fan, silencers, deflectors and brackets, certified for smoke extraction in accordance with standard EN-12101-3-2002, certification no. 0370-CPD-0394
- Turnable impellers cast aluminium designed for optimum thrust.
- Protection guard against contacts, in accordance with standard UNE 100250, in single-direction models
- Deflector to increase airflow range, on the impeller side. Reversible models are fitted with deflectors on both sides.
- Highly effective silencers with thermal and acoustic insulation
- Safety switch, IAT series, supplied built-in to the fan (THT/IMP-L and THT/IMP-O) or on request (THT/IMP-C)
- Airflow direction from motor to impeller or 100% reversible
- THT/IMP-C: Steel sheet circular casing
- THT/IMP-L: galvanized sheet steel casing
- THT/IMP-O: painted steel casing, with minimum height
- THT/IMP-LS: Casing limited



Deflector to increase range

Motor:

- Class H motors, ongoing use S1 and emergency use S2, with ball bearings and IP55 protection, 2-speed
- Three-phase 400V.-50Hz. DHALANDER
- Max. temperature of air for transport: S1 Service -20°C+ 40°C for ongoing use, S2 Service 200°C/2h, 300°C/2h, 400°C/2h

Finish:

- Anticorrosive in polyester resin, polymerised at 190°C, after alkaline degreasing and phosphate-free pre-treatment (THT/IMP-C, THT/IMP-O) or anticorrosive galvanized sheet steel (THT/IMP-L)

On request:

- Different thrust performance from that indicated.

Order code

THT/IMP O — UNI — 38 — 2/4T — 1,5 — F-400

THT/IMP:
Long-distance
impulse fans

Design
C: Circular casing
O: Painted casing
L: casing
LS: Casing
limited

Airflow direction
UNI: Unidirectional
REV: Reversible

Impeller
diameter
in cm.

Number of
motor poles
2=2900 r/min. 50 Hz
4=1400 r/min. 50 Hz
6=900 r/min. 50 Hz
8=750 r/min. 50 Hz
12=500 r/min. 50 Hz

T=Three-phase

Motor power
(c.v.)

F-200 Officially approved
200°C/2h
F-300 Officially approved,
tested for 300°C/2h
F-400 Officially approved
400°C/2h

Technical characteristics

Model	Speed (r/min)	Maximum current 400V (A)	Airflow (m ³ /h)	Thrust (N)	Outlet speed (m/s)	Power installed (kW)	LpA sound pressure at 10m dB(A)	Approx. weight (Kg)
Single-direction								
THT/IMP-C-UNI-31-2/4T	2860 / 1430	1.50 / 0.55	4260 / 2130	21/ 5	15.6 / 7.8	0.55 / 0.15	51 / 36	65
THT/IMP-C-UNI-35-2/4T	2875 / 1430	2.10 / 0.80	6360 / 3180	36/ 9	17.8 / 8.9	0.85 / 0.20	52 / 37	70
THT/IMP-C-UNI-38-2/4T-1.5	2900 / 1450	2.90 / 1.10	8450 / 4225	57/ 15	20.7 / 10.3	1.10 / 0.25	47 / 32	89
THT/IMP-C-UNI-40-2/4T-1.5	2900 / 1450	2.90 / 1.10	9250 / 4625	60/ 15	20.4 / 10.2	1.10 / 0.25	53 / 38	98
THT/IMP-C-UNI-45-2/4T-2	2940 / 1460	4.40 / 1.40	10800 / 5400	62/ 15	18.1 / 9.0	1.50 / 0.37	57 / 42	132
THT/IMP-C-UNI-45-2/4T-3	2930 / 1450	5.70 / 1.80	13200 / 6600	92/ 23	22.1 / 11.0	2.20 / 0.60	58 / 43	133
THT/IMP-C-UNI-50-2/4T-6	2930 / 1450	10.00 / 3.20	19700 / 9850	165/ 41	26.4 / 13.2	4.50 / 1.30	60 / 45	220
THT/IMP-O-UNI-29-2/4T	2860 / 1430	1.50 / 0.55	4000 / 2000	21/ 5	16.8 / 8.4	0.55 / 0.15	37 / 22	69
THT/IMP-O-UNI-35-2/4T	2875 / 1430	2.10 / 0.80	6360 / 3180	36/ 9	17.8 / 8.9	0.85 / 0.20	52 / 37	70
THT/IMP-O-UNI-38-2/4T-1.5	2900 / 1450	2.90 / 1.10	8450 / 4225	57/ 15	20.7 / 10.3	1.10 / 0.25	47 / 32	94
THT/IMP-O-UNI-40-2/4T-1.5	2900 / 1450	2.90 / 1.10	9250 / 4625	60/ 15	20.4 / 10.2	1.10 / 0.25	53 / 38	104
THT/IMP-O-UNI-45-2/4T-2	2940 / 1460	4.40 / 1.40	10800 / 5400	62/ 15	18.1 / 9.0	1.50 / 0.37	57 / 42	140
THT/IMP-O-UNI-45-2/4T-3	2930 / 1450	5.70 / 1.80	13200 / 6600	92/ 23	22.1 / 11.0	2.20 / 0.60	58 / 43	141
THT/IMP-O-UNI-50-2/4T-6	2930 / 1450	10.00 / 3.20	19700 / 9850	165/ 41	26.4 / 13.2	4.50 / 1.30	60 / 45	234
THT/IMP-L-UNI-29-2/4T	2860 / 1430	1.50 / 0.55	4000 / 2000	21/ 5	16.8 / 8.4	0.55 / 0.15	37 / 22	69
THT/IMP-L-UNI-35-2/4T	2875 / 1430	2.10 / 0.80	6360 / 3180	36/ 9	17.8 / 8.9	0.85 / 0.20	52 / 37	70
THT/IMP-L-UNI-38-2/4T-1.5	2900 / 1450	2.90 / 1.10	8450 / 4225	57/ 15	20.7 / 10.3	1.10 / 0.25	47 / 32	94
THT/IMP-L-UNI-40-2/4T-1.5	2900 / 1450	2.90 / 1.10	9250 / 4625	60/ 15	20.4 / 10.2	1.10 / 0.25	53 / 38	104
THT/IMP-L-UNI-45-2/4T-2	2940 / 1460	4.40 / 1.40	10800 / 5400	62/ 15	18.1 / 9.0	1.50 / 0.37	57 / 42	140
THT/IMP-L-UNI-45-2/4T-3	2930 / 1450	5.70 / 1.80	13200 / 6600	92/ 23	22.1 / 11.0	2.20 / 0.60	58 / 43	141
THT/IMP-L-UNI-50-2/4T-6	2930 / 1450	10.00 / 3.20	19700 / 9850	165/ 41	26.4 / 13.2	4.50 / 1.30	60 / 45	234
THT/IMP-LS-UNI-29-2/4T	2860 / 1430	1.50 / 0.55	4000 / 2000	21/ 5	16.8 / 8.4	0.55 / 0.15	39 / 24	55
THT/IMP-LS-UNI-35-2/4T	2875 / 1430	2.10 / 0.80	6360 / 3180	36/ 9	17.8 / 8.9	0.85 / 0.20	54 / 39	56
THT/IMP-LS-UNI-38-2/4T-1.5	2900 / 1450	2.90 / 1.10	8450 / 4225	57/ 15	20.7 / 10.3	1.10 / 0.25	49 / 34	76
THT/IMP-LS-UNI-40-2/4T-1.5	2900 / 1450	2.90 / 1.10	9250 / 4625	60/ 15	20.4 / 10.2	1.10 / 0.25	55 / 40	83
THT/IMP-LS-UNI-45-2/4T-2	2940 / 1460	4.40 / 1.40	10800 / 5400	62/ 15	18.1 / 9.0	1.50 / 0.37	59 / 44	112
THT/IMP-LS-UNI-45-2/4T-3	2930 / 1450	5.70 / 1.80	13200 / 6600	92/ 23	22.1 / 11.0	2.20 / 0.60	60 / 45	113
THT/IMP-LS-UNI-50-2/4T-6	2930 / 1450	10.00 / 3.20	19700 / 9850	165/ 41	26.4 / 13.2	4.50 / 1.30	62 / 47	187

Reversible

THT/IMP-C-REV-31-2/4T	2860 / 1430	1.50 / 0.55	3840 / 1920	17/ 4	14.1 / 7.0	0.55 / 0.15	50 / 35	63
THT/IMP-C-REV-35-2/4T	2875 / 1430	2.10 / 0.80	5940 / 2970	31/ 8	16.7 / 8.3	0.85 / 0.20	51 / 36	70
THT/IMP-C-REV-38-2/4T-2	2940 / 1460	4.40 / 1.40	8200 / 4100	54/ 14	20.1 / 10.0	1.50 / 0.37	49 / 34	91
THT/IMP-C-REV-40-2/4T-2	2940 / 1460	4.40 / 1.40	9250 / 4625	60/ 15	20.4 / 10.2	1.50 / 0.37	52 / 37	100
THT/IMP-C-REV-45-2/4T-2	2940 / 1460	4.40 / 1.40	10300 / 5150	56/ 14	17.2 / 8.6	1.50 / 0.37	56 / 41	131
THT/IMP-C-REV-45-2/4T-3	2930 / 1450	5.70 / 1.80	12800 / 6400	87/ 22	21.4 / 10.7	2.20 / 0.60	57 / 42	133
THT/IMP-C-REV-50-2/4T-6	2930 / 1450	10.00 / 3.20	19000 / 9500	153/ 38	25.4 / 12.7	4.50 / 1.30	60 / 45	267
THT/IMP-O-REV-29-2/4T	2860 / 1430	1.50 / 0.55	3400 / 1700	15/ 4	14.3 / 7.1	0.55 / 0.15	38 / 23	67
THT/IMP-O-REV-35-2/4T	2875 / 1430	2.10 / 0.80	5940 / 2970	31/ 8	16.7 / 8.3	0.85 / 0.20	51 / 36	70
THT/IMP-O-REV-38-2/4T-2	2940 / 1460	4.40 / 1.40	8200 / 4100	54/ 14	20.1 / 10.0	1.50 / 0.37	49 / 34	97
THT/IMP-O-REV-40-2/4T-2	2940 / 1460	4.40 / 1.40	9250 / 4625	60/ 15	20.4 / 10.2	1.50 / 0.37	52 / 37	106
THT/IMP-O-REV-45-2/4T-2	2940 / 1460	4.40 / 1.40	10300 / 5150	56/ 14	17.2 / 8.6	1.50 / 0.37	56 / 41	139
THT/IMP-O-REV-45-2/4T-3	2930 / 1450	5.70 / 1.80	12800 / 6400	87/ 22	21.4 / 10.7	2.20 / 0.60	57 / 42	141
THT/IMP-O-REV-50-2/4T-6	2930 / 1450	10.00 / 3.20	19000 / 9500	153/ 38	25.4 / 12.7	4.50 / 1.30	60 / 45	284
THT/IMP-L-REV-29-2/4T	2860 / 1430	1.50 / 0.55	3400 / 1700	15/ 4	14.3 / 7.1	0.55 / 0.15	38 / 23	67
THT/IMP-L-REV-35-2/4T	2875 / 1430	2.10 / 0.80	5940 / 2970	31/ 8	16.7 / 8.3	0.85 / 0.20	51 / 36	70
THT/IMP-L-REV-38-2/4T-2	2940 / 1460	4.40 / 1.40	8200 / 4100	54/ 14	20.1 / 10.0	1.50 / 0.37	49 / 34	97
THT/IMP-L-REV-40-2/4T-2	2940 / 1460	4.40 / 1.40	9250 / 4625	60/ 15	20.4 / 10.2	1.50 / 0.37	52 / 37	106
THT/IMP-L-REV-45-2/4T-2	2940 / 1460	4.40 / 1.40	10300 / 5150	56/ 14	17.2 / 8.6	1.50 / 0.37	56 / 41	139
THT/IMP-L-REV-45-2/4T-3	2930 / 1450	5.70 / 1.80	12800 / 6400	87/ 22	21.4 / 10.7	2.20 / 0.60	57 / 42	141
THT/IMP-L-REV-50-2/4T-6	2930 / 1450	10.00 / 3.20	19000 / 9500	153/ 38	25.4 / 12.7	4.50 / 1.30	60 / 45	284
THT/IMP-LS-REV-29-2/4T	2860 / 1430	1.50 / 0.55	3400 / 1700	15/ 4	14.3 / 7.1	0.55 / 0.15	40 / 25	55
THT/IMP-LS-REV-35-2/4T	2875 / 1430	2.10 / 0.80	5940 / 2970	31/ 8	16.7 / 8.3	0.85 / 0.20	53 / 38	56
THT/IMP-LS-REV-38-2/4T-2	2940 / 1460	4.40 / 1.40	8200 / 4100	54/ 14	20.1 / 10.0	1.50 / 0.37	51 / 36	77
THT/IMP-LS-REV-40-2/4T-2	2940 / 1460	4.40 / 1.40	9250 / 4625	60/ 15	20.4 / 10.2	1.50 / 0.37	53 / 39	85
THT/IMP-LS-REV-45-2/4T-2	2940 / 1460	4.40 / 1.40	10300 / 5150	56/ 14	17.2 / 8.6	1.50 / 0.37	58 / 43	111
THT/IMP-LS-REV-45-2/4T-3	2930 / 1450	5.70 / 1.80	12800 / 6400	87/ 22	21.4 / 10.7	2.20 / 0.60	59 / 44	113
THT/IMP-LS-REV-50-2/4T-6	2930 / 1450	10.00 / 3.20	19000 / 9500	153/ 38	25.4 / 12.7	4.50 / 1.30	62 / 47	227

Dimensions in mm

C: Circular casing

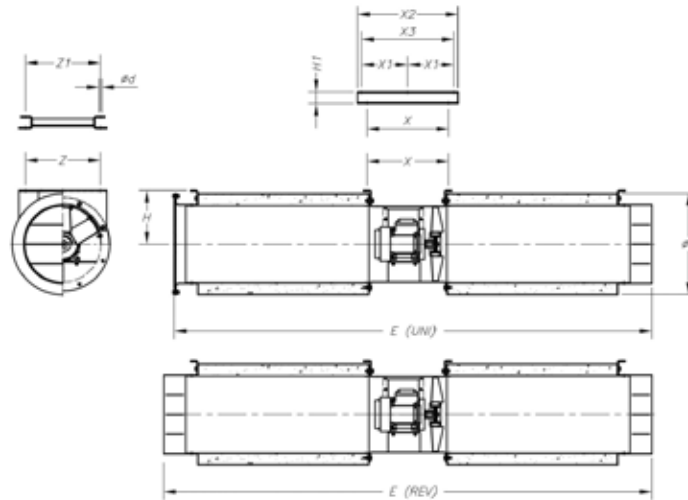

	ØD	Ød1	E(UNI)	E(REV)	H	H1	X	X1	X2	X3	Z	Z1
THT/IMP-C-31	415	10	1956	2000	220	-	345	-	-	-	275	-
THT/IMP-C-35	460	12	1960	2005	250	-	346	-	-	-	300	-
THT/IMP-C-38	415	12	2570	2620	225	-	-	-	600	530	-	517
THT/IMP-C-40	510	12	2485	2540	280	-	376	-	-	-	400	-
THT/IMP-C-45	630	12	2500	2554	355	-	396	-	-	-	440	-
THT/IMP-C-50	710	12	2895	2950	410	80	514	320	700	-	380	370

O: painted enclosure L: Surround LS: Surround small

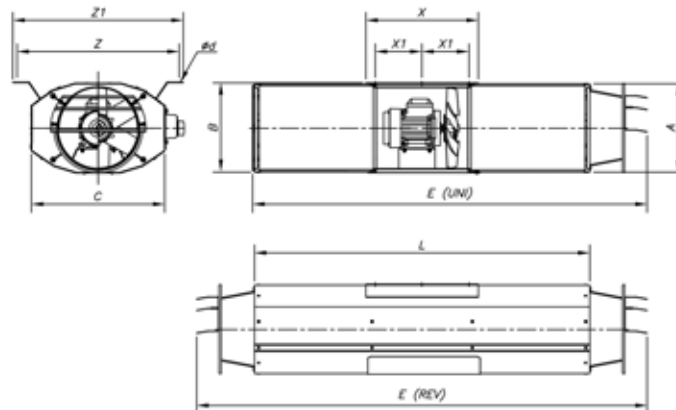

	A	B	C	ød	E(UNI)	E(REV)	L	X	X1	Z	Z1
THT/IMP-LS-29	319,5	324	479	12x26	1410	1610	1200	400	167	580	610
THT/IMP-L-29	319,5	324	479	12x26	2210	2410	2000	400	167	580	610
THT/IMP-O-29	319,5	324	479	12x26	2210	2410	2000	400	167	580	610
THT/IMP-LS-35	383	386	523	12x26	1410	1610	1200	400	167	614	644
THT/IMP-L-35	383	386	523	12x26	2210	2410	2000	400	167	614	644
THT/IMP-O-35	383	386	523	12x26	2210	2410	2000	400	167	614	644
THT/IMP-LS-38	406	409	550	12x26	1410	1610	1200	400	170	640	670
THT/IMP-L-38	406	409	550	12x26	2210	2410	2000	400	170	640	670
THT/IMP-O-38	406	409	550	12x26	2210	2410	2000	400	170	640	670
THT/IMP-LS-40	436	439	582	12x26	1410	1610	1200	400	170	670	700
THT/IMP-L-40	436	439	582	12x26	2210	2410	2000	400	170	670	700
THT/IMP-O-40	436	439	582	12x26	2210	2410	2000	400	170	670	700
THT/IMP-LS-45	486	489	630	12x26	1410	1610	1200	400	170	724	754
THT/IMP-L-45	486	489	630	12x26	2210	2410	2000	400	170	724	754
THT/IMP-O-45	486	489	630	12x26	2210	2410	2000	400	170	724	754
THT/IMP-LS-50	546	549	742	12x26	1445	1675	1200	580	255	778	808
THT/IMP-L-50	546	549	742	12x26	2245	2475	2000	580	255	778	808
THT/IMP-O-50	546	549	742	12x26	2245	2475	2000	580	255	778	808

Application in garages

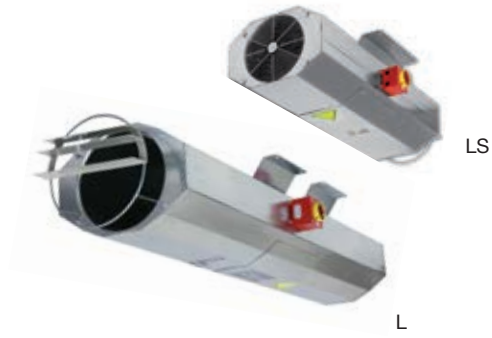

Installation of fan inside fire danger zone

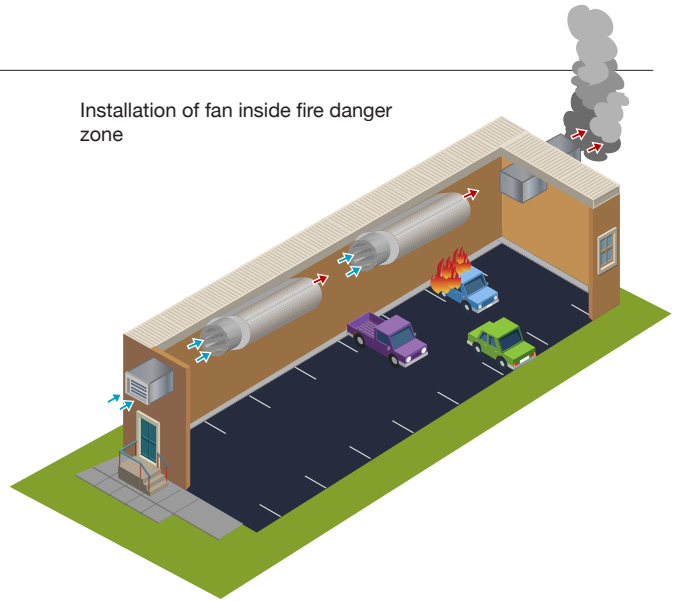

Accessories

See accessories section



TUNNEL JET FAN



Jet fans especially designed for tunnel ventilation. 400°C/2h, 300°C/2h and 200°C/2h Certificates according to model

Powerful jet fans especially designed for tunnels ventilation for the smoke extraction in case of fire 400°C/2h, 300°C/2h and 200°C/2h according to model.

THT/IMP: Single-direction jet fan of great strength and cast-aluminium impeller construction for medium thrust. 400°C/2h, 300°C/2h and 200°C/2h Certificates

VST: 95% reversible jet fan in both direction of turn, of great strength and stainless steel impeller construction for high-performance thrust. Certified 400°C/2h



Fan:

- Sheet steel thick long casing
- Motor base welded to the casing
- Aerodynamic inlet and discharge cone.
- Optimum surface protection by means of high-quality steel.
- Model VST: 95% reversible impeller in the inverse direction, of high aerodynamic performance, built with hollow-profile stainless-steel blades.
- Model THT/IMP: Single-direction, cast aluminium impeller.
- THT/IMP-C: Base plate especially designed to support the entire unit. From diameter 560 mm upwards supplied with anti-vibration damper springs
- Tubular silencer connected to both ends which provides a high degree of thermal and acoustic insulation.
- Electrical connection in outside connecting box.
- E90-type cable with metallic protection.
- Stand based or bed based according to model, included in the set
- Shock absorbers
- Safety anchorage included
- Model VST: Approval according to Standard: EN-12101-3, with certification no. 1511-CPD-128.
- Model THT/IMP: Approval according to Standard: EN-12101-3, with certification no. 0370-CPD-0305.



High performance impeller

Motor:

- Class H motors, ongoing use S1 and emergency use S2, with ball bearings and IP55 protection
- Three-phase 400/690V.-50Hz
- Max. temperature of air for transport:
- S1 Service -20°C + 70°C for ongoing use
- S2 Service 400°C/2h for VST
- S2 service 400°C/2h, 300°C/2h and 200°C/2h for THT/IMP

Finish:

- High-protection, anti-corrosion steel, specially primed and high-quality paint for corrosive environments.

On request:

- Standardised IP-55 motors, ATEX motors and two speeds
- Made entirely from stainless steel.
- Hot-rolled galvanised steel construction



Guidelines for pressure gain



Order code

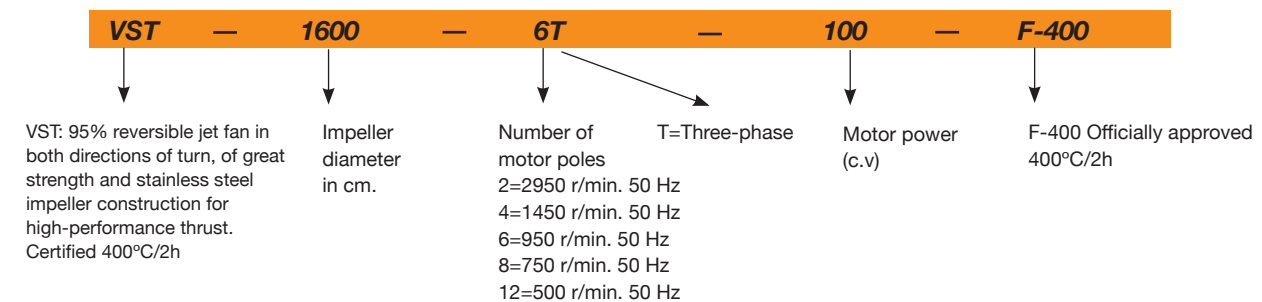
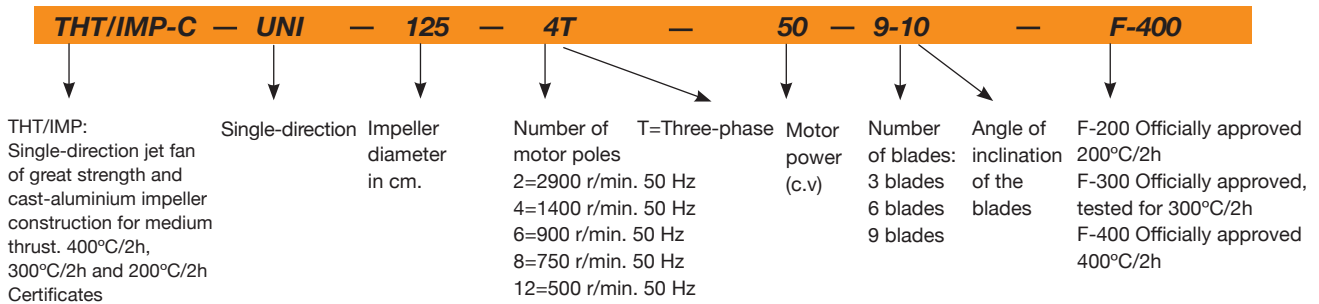

Technical characteristics

Model	Speed (r/min)	Maximum admissible current 400V (A)	Airflow (m³/h)	Thrust (N)	Speed Impulsion (m/s)	Power installed (kW)	LpA sound pressure at 10m dB(A)	Approx. weight (Kg)
THT/IMP-C-UNI-56-2T-12	2950	19.20	29500	312	37.6	9.00	64	273
THT/IMP-C-UNI-56-4T-2	1425	3.80	14550	76	16.4	1.50	50	197
THT/IMP-C-UNI-63-2T-22	2960	32.30	40050	455	37.1	16.00	68	323
THT/IMP-C-UNI-63-4T-3	1435	5.30	21550	132	19.2	2.20	53	241
THT/IMP-C-UNI-71-4T-4	1430	6.60	28550	182	20.0	3.00	65	279
THT/IMP-C-UNI-80-4T-5.5	1440	8.40	36900	239	20.4	4.00	63	414
THT/IMP-C-UNI-90-4T-10	1460	17.70	52000	375	22.7	7.50	65	495
THT/IMP-C-UNI-100-4T-15	1455	23.00	66500	497	23.5	11.00	63	667
THT/IMP-C-UNI-125-4T-30	1470	42.00	98100	692	22.2	22.00	59	980
THT/IMP-C-UNI-125-4T-50	1480	73.00	123700	1101	28.0	37.00	62	1110

Model	Speed (r/min)	Airflow maximum (m³/h)	Thrust (N)	Speed Impulsion (m/s)	Discharge area (m²)	Max. Power installed (kW)	Approx. weight (Kg)
VST-560-2T	2950	27669	289	31	0.25	18.5	350
VST-630-2T	2950	39314	461	35	0.31	18.5	355
VST-710-2T	2950	48876	561	34	0.40	18.5	380
VST-800-2T	2950	72489	972	40	0.50	37	520
VST-800-4T	1450	38205	270	21	0.50	30	425
VST-900-2T	2950	86754	1100	38	0.64	37	770
VST-900-4T	1450	56466	466	25	0.64	30	650
VST-1000-2T	2950	115013	1566	41	0.79	55	835
VST-1000-4T	1450	81586	788	29	0.79	55	710
VST-1120-4T	1450	112949	1204	32	0.99	45	940
VST-1250-4T	1450	157857	1888	36	1.23	90	1030
VST-1400-4T	1450	201032	2441	36	1.54	90	1385
VST-1600-4T	1450	318874	4644	44	2.01	200	1890

* Models 1800 and 2000 to consult

Dimensions in mm

THT/IMP-C

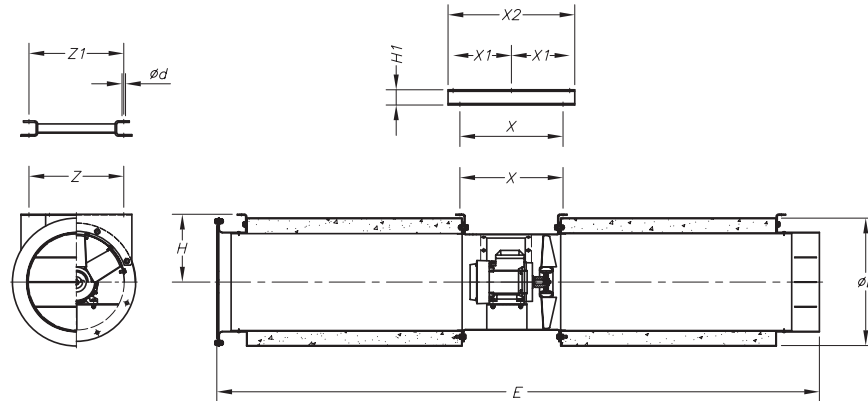

MODEL	ϕD	ϕd	E	H	H1	X	X1	X2	Z	Z1
THT/IMP-C-56	750	12	3145	415	80	558	345	750	475	465
THT/IMP-C-63	800	14	3295	435	80	706	418	900	550	540
THT/IMP-C-71	900	14	3145	510	80	558	345	750	475	465
THT/IMP-C-80	1000	14	3850	565	80	656	395	855	730	730
THT/IMP-C-90	1100	14	3850	585	80	677	405.5	876	825	825
THT/IMP-C-100	1200	14	4950	640	80	767	450	965	884	884
THT/IMP-C-125	1555	17	3620	840	100	717	575	1250	1150	1150

VST

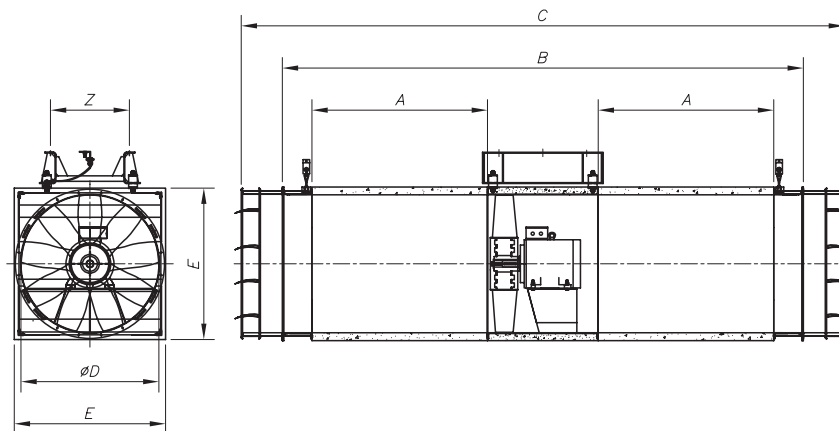

Model	A	B	C	ϕD	E	Z
VST-560	1950	4380	4780	562	762	380
VST-630	1950	4600	5000	632	832	462
VST-710	1950	4630	5030	713	913	546
VST-800*	1450/1950	3900/4900	4300/5300	804	1004	610
VST-900*	1450/1950	4000/5000	4400/5400	904	1104	660
VST-1000*	1450/1950	4025/5025	4425/5425	1005	1205	730
VST-1120	1700	4750	5150	1128	1328	760
VST-1250	1700	4750	5150	1258	1458	786
VST-1400	1950	5610	6010	1410	1610	768
VST-1600	1950	5900	6300	1610	1810	868

* Length of the silencer for a four-pole / two-pole motor

Characteristic curves

Q = Airflow in m³/h, m³/s and cfm.

Pe = Static pressure in mm.w.c., Pa and inwg.

— Pressure - - - Thrust (N)

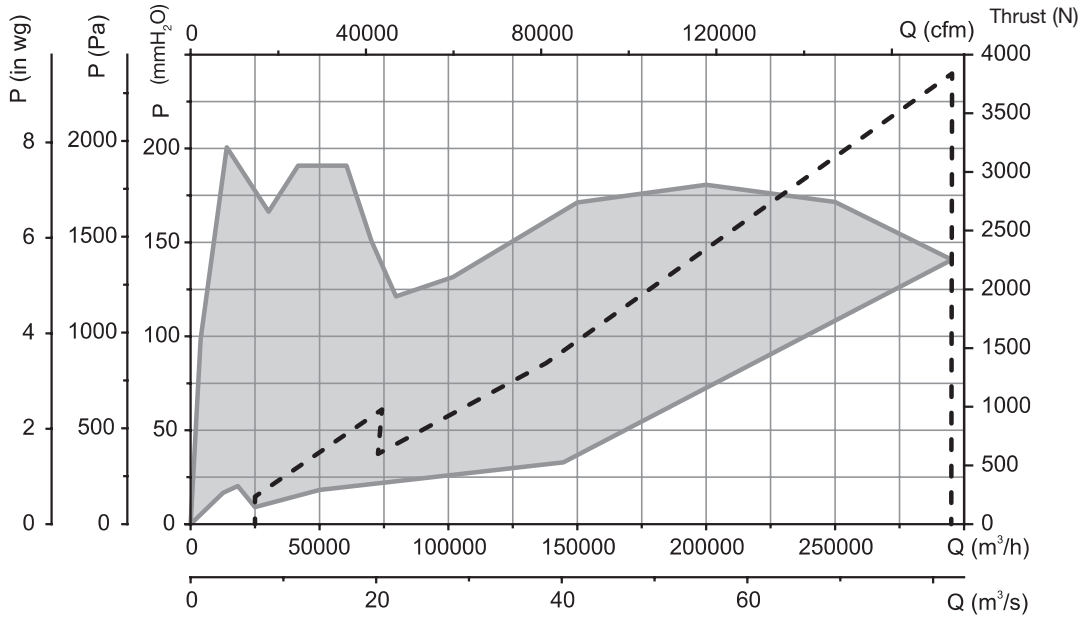

Examples of use

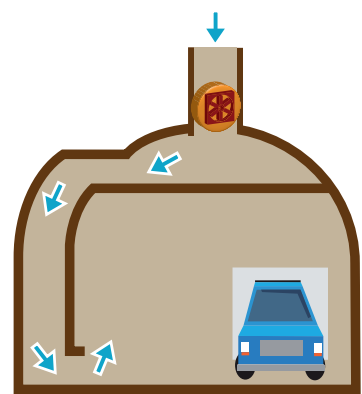
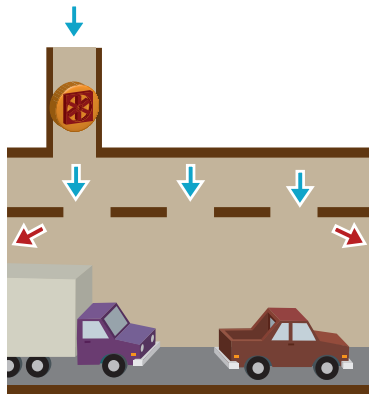

Accessories

See accessories section



VMSF

Cased high-pressure axial fans, certified 400°C/2h

Cased axial high-pressure fans of great strength, especially designed for installations for smoke extraction with large losses of load, certified 400°C/2h.



Fan:

- Sheet steel thick long casing
- Motor base welded to the casing
- Guidelines for high aerodynamic performance for pressure gain
- Optimum surface protection by means of high-quality steel.
- High-performance, cast aluminium impeller.
- Airflow direction from impeller to motor
- Electrical connection in outside terminal board.
- E90-type cable with metallic protection.
- Stand based or bed based according to model, included in the set
- Shock absorbers
- Approval according to Standard: EN-12101-3, with certification no. 1511-CPD-104.

Motor:

- Class H motors, ongoing use S1 and emergency use S2, with ball bearings and IP55 protection
- Three-phase 400/690V.-50Hz
- Max. temperature of air for transport:
- S1 Service -20°C + 70°C for ongoing use
- S2 Service 400°C/2h

Finish:

- High-protection, anti-corrosion steel, specially primed and high-quality paint for corrosive environments.

On request:

- Standardised IP-55 motors, ATEX motors and two speeds
- Stainless steel or iron impellers
- Made entirely from stainless steel.
- Hot-rolled galvanised steel construction



High pressure impeller

Order code

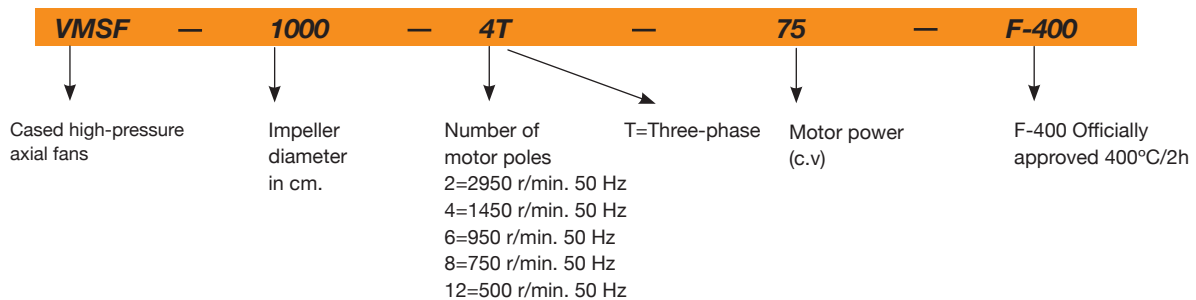

Technical characteristics

Model	Speed	Max. Power installed and recommended (kW)	Airflow (m³/h)	Approx. weight max.	
	(r/min)			min.	(Kg) max.
VMSF-500-2T	2950	4	19000	93	102
VMSF-500-4T	1450	2.2	10259	93	102
VMSF-560-2T	2950	5.5	23530	103	133
VMSF-560-4T	1450	2.2	14356	103	133
VMSF-630-2T	2950	22	41410	120	252
VMSF-630-4T	1450	3	20397	120	252
VMSF-710-4T	1450	5.5	29363	137	238
VMSF-800-4T	1450	11	42079	173	238
VMSF-900-4T	1450	15	59999	214	290
VMSF-1000-4T	1450	30	82256	235	428
VMSF-1000-6T	950	7.5	53963	235	428
VMSF-1120-4T	1450	45	115506	504	910
VMSF-1120-6T	950	15	75850	504	910
VMSF-1250-4T	1450	75	159321	619	1180
VMSF-1250-6T	950	22	104031	619	1180

* Models 1400 and 1600 to consult

Dimensions in mm

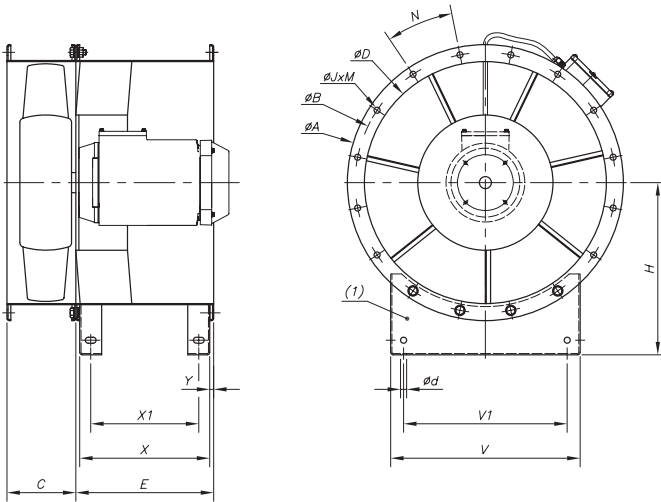

Model	ØA	ØB	C	øD	ød	E	H
VMSF-500	570	541	126	502	14	252	357
VMSF-560	641	605	160	562	14	320	400
VMSF-630	725	674	185	632	14	370	435
VMSF-710	805	755	185	713	14	370	500
VMSF-800	905	841	195	804	14	390	560
VMSF-900	1005	945	225	905	14	450	639
VMSF-1000	1105	1045	225	1005	14	450	690
VMSF-1120	1126	1175	270	1128	14	540	750
VMSF-1250	1370	1311	270	1258	14	540	790
VMSF-1400	1530	1469	330	1410	18	670	900
VMSF-1600	1742	1665	400	1610	18	800	1000

Model	øJxM	N	V	V1	X	X1	Y
VMSF-500	ø11.5x12	30°	438	360	235	185	8.5
VMSF-560	ø14x16	22°30'	440	380	320	252	9
VMSF-630	ø14x16	22°30'	530	462	352	302	9
VMSF-710	ø14x16	22°30'	688	546	352	287	9
VMSF-800	ø14x16	22°30'	760	610	370	305	10
VMSF-900	ø14x16	22°30'	840	660	430	365	10
VMSF-1000	ø14x16	22°30'	930	730	430	365	10
VMSF-1120	ø14x20	18°	885	760	518	478	11
VMSF-1250	ø14x20	18°	986	786	518	438	11
VMSF-1400	ø14x24	15°	1007	767	644	564	13
VMSF-1600	ø14x24	15°	1067	867	772	672	13

(1) Accessory

Characteristic curves

Q = Airflow in m³/h, m³/s and cfm.

Pe = Static pressure in mm.w.c., Pa and inwg.

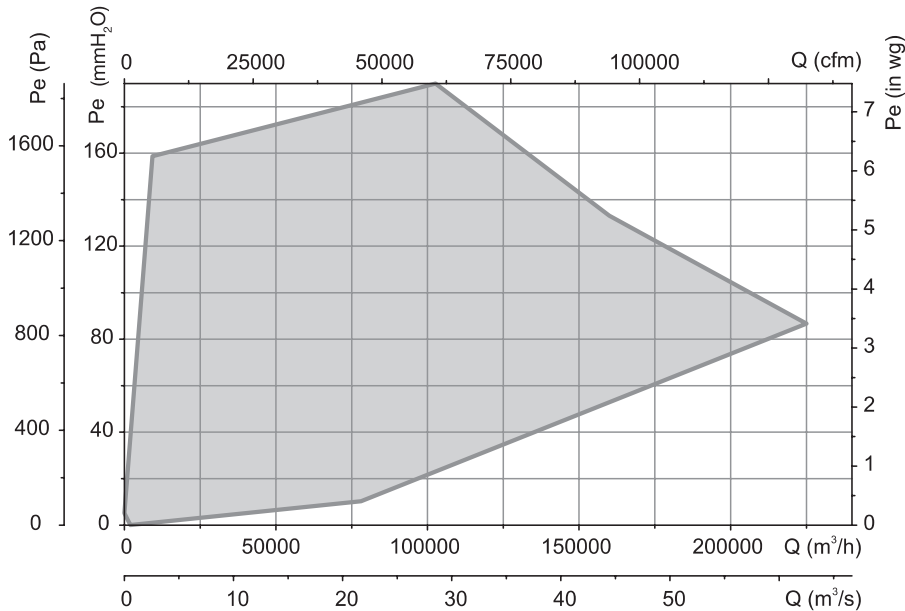

Accessories

See accessories section



CI

Centrifugal long-range induction and impulsion fans 300°C/2h and 400°C/2h, for working within the fire danger zones, with low profile



Centrifugal long-range induction and impulsion fans 300°C/2h and 400°C/2h, for working within the fire danger zones, with low profile

Fan:

- Steel sheet casing
- Impeller with backward-curved blades made from robust sheet steel
- Outside connecting box.
- Fixing stand included



Outside connecting box. Fixing stand

Motor:

- Class H motors, ongoing use S1 and emergency use S2, with ball bearings, IP55 protection, and one- or two- speed depending on the model
- Three-phase 230/400V.50Hz.

- Max. temperature of air for transport: S1 Service -20°C+ 40°C for ongoing use, S2 Service 300°C/2h and 400°C/2h

Finish:

- Anticorrosive finish in polyester resin, polymerised at 190°C, after alkaline degreasing and phosphate-free pre-treatment.

Order code

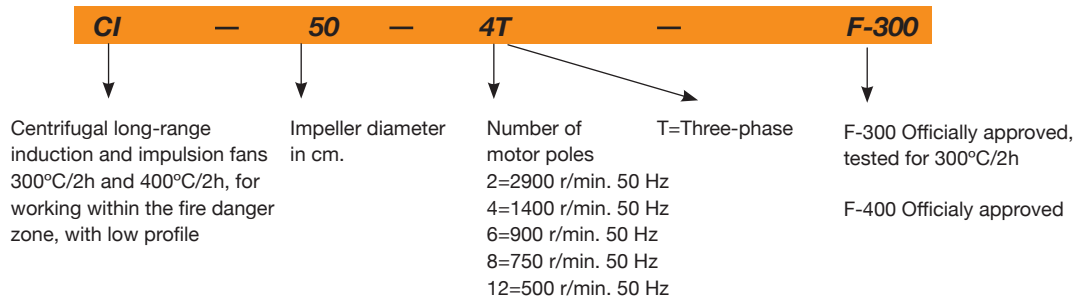

Technical characteristics

Model	Speed (r/min)	Maximum admissible current (A)		Airflow (m³/h)	Thrust (N)	Power installed (kW)	LpA sound pressure at 1m dB(A)	Approx. weight (Kg)
		230V	400V					
CI-50-4T	1395	5.00	2.90	6050	50	1.20	78	83
CI-50-4/8T	1395/650		2.90 / 1.20	6050 / 3020	50 / 13	1.20 / 0.30	78/63	83
CI-75-4T	1450	9.00	5.20	8080	75	2.20	85	139
CI-75-4/8T	1450/730		5.20 / 2.05	8080 / 4040	75 / 19	2.20 / 0.37	85/70	139
CI-100-4T	1445	9.90	5.70	9340	100	2.40	89	141
CI-100-4/8T	1445/715		5.70 / 2.20	9340 / 4670	100 / 25	2.40 / 0.55	89/14	141

Dimensions in mm

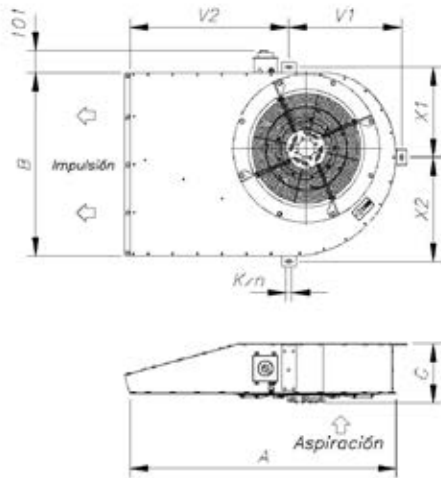

	A	B	C	V2	V1	X1	X2	Kxn
CI-50-F300	1240	840	272,5	741,5	524,5	413	477	12x26
CI-50-F400	1240	840	261,5	741,5	524,5	413	477	12x26
CI-75-F300	1778	1040	311	1143	662	494	596	12x26
CI-75-F400	1778	1040	299	1143	662	494	596	12x26
CI-100 F-300	1778	1040	323	1143	662	494	596	12x26
CI-100 F-400	1778	1040	323	1143	662	494	596	12x26

Accessories

See accessories section



HTMF

Multifunctional 400°C/2h and 300°C/2h roof fans

Multifunctional 400°C/2h ceiling fans to work inside fire danger zones, designed to smoke extraction in industrial or similar buildings.

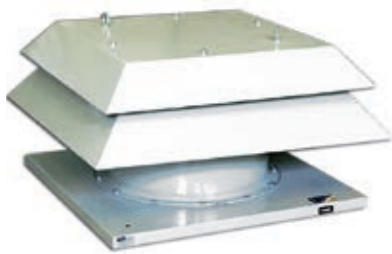

Hood with natural outlet air due to differential pressure

Fan:

- Sheet steel base plate.
- Turnable impellers cast aluminium.
- Protection guard, meets UNE 100250 standard
- Sheet steel hood with natural outlet air. Approval according to Standard EN-12101-3-2002, certificate no.:0370-CPD-0544

Motor:

- Class H motors, ongoing use S1 and emergency use S2, with ball bearings, IP55 protection, and one- or two- speed depending on the model.
- Three-phase 230/400V.-50Hz. (up to 4CV.) and 400/690V.-50Hz. (power over 4CV.)
- Max. temperature of air for transport: S1 Service -20°C+ 40°C for ongoing use, S2 Service 300°C/2h, 400°C/2h

Finish:

- Anticorrosive finish in polyester resin, polymerised at 190°C, after alkaline degreasing and phosphate-free pre-treatment.

On request:

- Fans with 200°C/2h one- or two-speed motor



Order code

HTMF — 56 — 4T — 2 — F-400

HTMF: Multifunctional 400°C/2h and 300°C/2h roof fans

Impeller diameter in cm.

Number of motor poles
 T=Three-phase
 2=2900 r/min. 50 Hz
 4=1400 r/min. 50 Hz
 6=900 r/min. 50 Hz
 8=750 r/min. 50 Hz
 12=500 r/min. 50 Hz

Power motor (c.v.)

F-300 Officially approved, tested for 300°C/2h
 F-400 Officially approved 400°C/2h

Technical characteristics

Model	Speed (r/min)	Maximum admissible current (A)			Power installed (kW)	Airflow maximum (m³/h)	Sound pressure (1) level dB(A)		Approx. weight (Kg)
		230V	400V	690V			Inlet	Outlet	
HTMF-56-4T-1	1430	3.80	2.20		0.75	10545	62	59	79
HTMF-56-4T-1.5	1420	4.70	2.70		1.10	11400	63	60	79
HTMF-56-4/8T-1.5	1440/710		2.90 / 1.40		1.10/0.25	11400 / 5700	63 / 48	60 / 45	79
HTMF-56-6T-0.75	930	3.30	1.90		0.55	8170	51	49	80
HTMF-63-4T-1.5	1420	4.70	2.70		1.10	13870	65	62	94
HTMF-63-4/8T-1.5	1440/710		2.90 / 1.40		1.10/0.25	13870 / 6935	65 / 50	62 / 47	94
HTMF-63-4T-2	1425	6.60	3.80		1.50	15485	66	63	96
HTMF-63-4/8T-2	1415/715		3.60 / 1.50		1.50/0.30	15485 / 7742	66 / 51	63 / 48	106
HTMF-63-4T-3	1435	9.20	5.30		2.20	17955	67	64	108
HTMF-63-4/8T-3	1415/715		5.20 / 1.90		2.20/0.45	17955 / 8977	67 / 52	64 / 49	112
HTMF-63-6T-0.75	930	3.30	1.90		0.55	10260	56	54	95
HTMF-63-6T-1	940	4.40	2.60		0.75	11305	57	55	95
HTMF-71-4T-2	1425	6.60	3.80		1.50	16150	69	66	109
HTMF-71-4/8T-2	1415/715		3.60 / 1.50		1.50/0.30	16150 / 8075	69 / 54	66 / 51	119
HTMF-71-4T-3	1435	9.20	5.30		2.20	18430	71	68	122
HTMF-71-4/8T-3	1415/715		5.20 / 1.90		2.20/0.45	18430 / 9215	71 / 56	68 / 53	125
HTMF-71-4T-4	1430	11.40	6.60		3.00	22610	72	69	133
HTMF-71-4/8T-4	1420/705		6.90 / 2.30		3.00/0.60	22610 / 11305	72 / 57	69 / 54	135
HTMF-71-6T-1	940	4.40	2.60		0.75	13205	58	56	109

Technical characteristics

Model	Speed (r/min)	Maximum admissible current (A)			Power installed (kW)	Airflow maximum (m³/h)	Sound pressure (1) level dB(A)		Approx. weight (Kg)
		230V	400V	690V			Inlet	Outlet	
HTMF-71-6T-1.5	945	6.40	3.70		1.10	16245	59	57	116
HTMF-80-4T-4	1430	11.40	6.60		3.00	27600	73	70	163
HTMF-80-4/8T-4	1420/705		6.90 / 2.30		3.00/0.60	27600 / 13800	73 / 58	70 / 55	165
HTMF-80-4T-5.5	1440		8.40	4.85	4.00	30176	74	71	163
HTMF-80-4/8T-5.5	1450/720		9.40 / 3.50		4.00/0.80	30176 / 15088	74 / 59	71 / 56	195
HTMF-80-6T-1.5	945	6.40	3.70		1.10	19412	62	60	145
HTMF-80-6T-2	945	7.40	4.30		1.50	22172	63	61	148
HTMF-80-6T-3	950	10.30	5.90		2.20	24932	64	62	160
HTMF-80-8T-1	710	4.80	2.80		0.75	16376	61	60	151
HTMF-90-4T-5.5	1440		8.40	4.85	4.00	35052	79	76	208
HTMF-90-4/8T-5.5	1450/720		9.40 / 3.50		4.00/0.80	35052 / 17526	79 / 64	76 / 61	238
HTMF-90-4T-7.5	1430		11.50	6.64	5.50	38456	81	78	240
HTMF-90-4/8T-7.5	1455/725		12.80 / 4.60		5.50/1.10	38456 / 19228	81 / 66	78 / 63	243
HTMF-90-4T-10	1460		17.70	10.22	7.50	41308	82	79	244
HTMF-90-4/8T-9	1455/725		15.50 / 5.50		6.70/1.50	41308 / 20654	82 / 67	79 / 64	243
HTMF-90-6T-3	950	10.30	5.90		2.20	29256	68	66	205
HTMF-90-6/12T-3	940/470		5.60 / 2.20		2.20/0.37	29256 / 14628	68 / 53	66 / 51	245
HTMF-90-6T-4	945	15.00	8.70		3.00	32016	69	67	235
HTMF-90-6/12T-4	970/475		8.90 / 3.50		3.00/0.55	32016 / 16008	69 / 54	67 / 52	245
HTMF-90-8T-1	710	4.80	2.80		0.75	17020	61	60	196
HTMF-90-8T-2	700	9.00	5.20		1.50	19596	63	62	208
HTMF-100-4T-7.5	1430		11.50	6.64	5.50	40756	84	81	265
HTMF-100-4/8T-7.5	1455/725		12.80 / 4.60		5.50/1.10	40756 / 20378	84 / 69	81 / 66	269
HTMF-100-4T-10	1460		17.70	10.22	7.50	47564	85	82	269
HTMF-100-4/8T-9	1455/725		15.50 / 5.50		6.70/1.50	44528 / 22264	84 / 69	81 / 66	269
HTMF-100-4T-15	1455		23.00	13.28	11.00	51336	86	83	332
HTMF-100-4/8T-14	1470/725		23.20 / 8.70		11.00/2.80	48300 / 24150	85 / 70	82 / 67	301
HTMF-100-6T-3	950	10.30	5.90		2.20	32476	74	72	231
HTMF-100-6/12T-3	940/470		5.60 / 2.20		2.20/0.37	32476 / 16238	74 / 59	72 / 57	271
HTMF-100-6T-4	945	15.00	8.70		3.00	35420	75	73	260
HTMF-100-6/12T-4	970/475		8.90 / 3.50		3.00/0.55	35420 / 17710	75 / 60	73 / 58	271
HTMF-100-6T-5.5	970		11.00	6.35	4.00	40020	76	74	277
HTMF-100-6/12T-5.5	970/480		11.30 / 4.20		4.00/0.65	40020 / 20010	76 / 61	74 / 59	289
HTMF-100-8T-3	705	13.20	7.60		2.20	26404	69	68	260
HTMF-100-8T-4	710	15.60	9.00		3.00	28704	70	69	270

(1) The sound level values are free field measurements of pressure in dB(A) at a distance of 6 m.



Erp. BEP (best efficiency point) characteristics

<(°)	Angle of inclination of the blades, in degrees	SR	Specific ratio
PN	Motor's nominal power in kW	ηe[%]	Efficiency
MC	Measurement category	N	Efficiency grade
EC	Efficiency category	[kW]	Input power
S	Static	[m³/h]	Airflow
T	Total	[mmH²O]	Static or total pressure (According to EC)
VSD	Variable-speed drive	[RPM]	Speed

	MC	EC	VSD	SR	ηe[%]	N	(kW)	(m³/h)	(mmH ₂ O)	(RPM)
HTMF-56-4T-1	C	S	NO	1.00	35.4%	38.2	0.855	7901	14.07	1443
HTMF-56-4T-1.5	B	T	NO	1.00	48.5%	49.7	1.155	11340	18.14	1438
HTMF-56-4/8T-1.5	B	T	NO	1.00	44.9%	46.9	1.330	11588	18.94	1449
HTMF-56-6T-0.75	B	T	NO	1.00	42.7%	45.4	0.515	9212	8.77	955
HTMF-63-4T-1.5	C	S	NO	1.00	48.2%	49.6	1.106	10387	18.88	1440
HTMF-63-4/8T-1.5	C	S	NO	1.00	41.3%	46.6	1.376	10605	19.68	1447
HTMF-63-4T-2	C	S	NO	1.00	42.4%	41.9	1.542	12016	20.00	1444
HTMF-63-4/8T-2	C	S	NO	1.00	37.2%	41.7	1.705	11892	19.59	1430
HTMF-63-4T-3	B	T	NO	1.00	62.4%	62.1	2.190	19423	25.86	1450
HTMF-63-4/8T-3	B	T	NO	1.00	56.0%	58.2	2.421	19373	25.73	1432
HTMF-63-6T-0.75	B	T	NO	1.00	56.1%	58.6	0.545	11393	9.86	956
HTMF-63-6T-1	B	T	NO	1.00	54.9%	55.3	0.799	13916	11.57	957
HTMF-71-4T-2	C	S	NO	1.00	48.5%	47.3	1.493	13409	19.84	1446
HTMF-71-4/8T-2	C	S	NO	1.00	42.6%	47.1	1.651	13275	19.45	1433
HTMF-71-4T-3	C	S	NO	1.00	44.7%	45.7	2.161	16356	21.67	1450



Erp. BEP (best efficiency point) characteristics

Modelo	MC	EC	VSD	SR	ηe[%]	N	(kW)	(m³/h)	(mmH₂O)	(RPM)
HTMF-71-4/8T-3	C	S	NO	1.00	40.1%	42.8	2.389	16314	21.56	1433
HTMF-71-4T-4	B	T	NO	1.00	68.4%	66.3	2.872	23676	30.48	1447
HTMF-71-4/8T-4	B	T	NO	1.00	61.6%	65.2	3.237	23797	30.80	1433
HTMF-71-6T-1	B	T	NO	1.00	62.4%	61.1	0.821	14945	12.60	957
HTMF-71-6T-1.5	B	T	NO	1.00	59.2%	59.1	1.149	18001	13.88	960
HTMF-80-4T-4	C	S	NO	1.00	46.9%	46.2	3.221	20108	27.62	1441
HTMF-80-4/8T-4	C	S	NO	1.00	42.3%	45.4	3.636	20222	27.93	1424
HTMF-80-4T-5.5	C	S	NO	1.00	45.5%	45.1	4.550	23694	32.11	1444
HTMF-80-4/8T-5.5	C	S	NO	1.00	43.3%	40.8	4.696	23552	31.72	1457
HTMF-80-6T-1.5	C	S	NO	1.00	38.9%	40.4	1.356	15261	12.68	953
HTMF-80-6T-2	B	T	NO	1.00	61.3%	61.4	1.847	24165	17.21	950
HTMF-80-6T-3	B	T	NO	1.00	64.9%	63.5	2.293	26615	20.53	960
HTMF-80-8T-1	B	T	NO	1.00	51.2%	56.4	1.128	18865	11.24	710
HTMF-90-4T-5.5	C	S	NO	1.00	51.0%	50.3	4.498	27512	30.65	1445
HTMF-90-4/8T-5.5	C	S	NO	1.00	48.6%	45.5	4.642	27348	30.28	1457
HTMF-90-4T-7.5	C	S	NO	1.00	47.8%	45.3	6.349	31725	35.17	1435
HTMF-90-4/8T-7.5	C	S	NO	1.00	43.0%	40.2	6.930	31525	34.73	1459
HTMF-90-4T-10	C	S	NO	1.01	45.4%	38.4	7.969	35188	37.75	1469
HTMF-90-4/8T-9	C	S	NO	1.00	43.0%	39.2	7.861	33548	36.97	1461
HTMF-90-6T-3	C	S	NO	1.00	42.8%	43.2	2.403	23147	16.33	958
HTMF-90-6/12T-3	C	S	NO	1.00	37.5%	41.4	2.643	22863	15.94	947
HTMF-90-6T-4	B	T	NO	1.00	63.7%	58.5	3.207	32972	22.77	957
HTMF-90-6/12T-4	B	T	NO	1.00	55.3%	57.4	3.696	32972	22.77	973
HTMF-90-8T-1	C	S	NO	1.00	36.4%	42.1	1.037	15838	8.76	713
HTMF-90-8T-2	B	T	NO	1.00	58.5%	55.4	1.402	24325	12.38	720
HTMF-100-4T-7.5	C	S	NO	1.00	50.5%	47.7	6.311	33024	35.42	1435
HTMF-100-4/8T-7.5	C	S	NO	1.00	45.4%	42.3	6.889	32817	34.98	1459
HTMF-100-4T-10	C	S	NO	1.00	48.1%	38.9	8.330	37734	39.02	1468
HTMF-100-4/8T-9	C	S	NO	1.00	45.8%	41.8	7.928	35548	37.50	1461
HTMF-100-4T-15	C	S	NO	1.01	44.1%	40.6	12.154	44732	43.97	1459
HTMF-100-4/8T-14	C	S	NO	1.01	39.0%	40.9	14.126	45164	44.82	1468
HTMF-100-6T-3	C	S	NO	1.00	45.4%	45.4	2.508	24808	16.87	956
HTMF-100-6/12T-3	C	S	NO	1.00	39.8%	43.6	2.754	24492	16.44	944
HTMF-100-6T-4	C	S	NO	1.00	41.1%	38.5	3.719	29458	19.07	950
HTMF-100-6/12T-4	C	S	NO	1.00	35.7%	38.1	4.286	29458	19.07	969
HTMF-100-6T-5.5	B	T	NO	1.00	61.3%	57.5	4.864	44005	24.89	972
HTMF-100-6/12T-5.5	B	T	NO	1.00	56.5%	55.4	5.437	44437	25.38	970
HTMF-100-8T-3	B	T	NO	1.00	52.5%	55.1	2.675	33957	15.20	710
HTMF-100-8T-4	B	T	NO	1.00	54.2%	55.3	2.771	41581	13.28	722

Internal fan data

Acoustic features

Values taken at inlet with maximum airflow. Values taken at outlet with maximum airflow.

Sound power Lw(A) spectrum in dB(A) via frequency band in Hz.

Model	63	125	250	500	1000	2000	4000	8000	Model	63	125	250	500	1000	2000	4000	8000
56-4-1	46	67	74	79	82	78	71	60	71-4-2	50	71	78	83	86	82	75	64
56-4-1	43	64	71	76	79	75	68	57	71-4-3	55	76	83	88	91	87	80	69
56-4-1.5	47	68	75	80	83	79	72	61	71-4-3	52	73	80	85	88	84	77	66
56-4-1.5	44	65	72	77	80	76	69	58	71-4-4	56	77	84	89	92	88	81	70
56-6	35	56	63	68	71	67	60	49	71-4-4	53	74	81	86	89	85	78	67
56-6	33	54	61	66	69	65	58	47	71-6-1	42	63	70	75	78	74	67	56
56-8	32	53	60	65	68	64	57	46	71-6-1	40	61	68	73	76	72	65	54
56-8	29	50	57	62	65	61	54	43	71-6-1.5	43	64	71	76	79	75	68	57
63-4-1.5	49	70	77	82	85	81	74	63	71-6-1.5	41	62	69	74	77	73	66	55
63-4-1.5	46	67	74	79	82	78	71	60	71-8-2	38	59	66	71	74	70	63	52
63-4-2	50	71	78	83	86	82	75	64	71-8-2	35	56	63	68	71	67	60	49
63-4-2	47	68	75	80	83	79	72	61	71-8-3	40	61	68	73	76	72	65	54
63-4-3	51	72	79	84	87	83	76	65	71-8-3	37	58	65	70	73	69	62	51
63-4-3	48	69	76	81	84	80	73	62	71-8-4	41	62	69	74	77	73	66	55
63-6-0,75	40	61	68	73	76	72	65	54	71-8-4	38	59	66	71	74	70	63	52
63-6-0,75	38	59	66	71	74	70	63	52	80-4-4	57	78	85	90	93	89	82	71
63-6-1	41	62	69	74	77	73	66	55	80-4-4	54	75	82	87	90	86	79	68
63-6-1	39	60	67	72	75	71	64	53	80-4-5.5	58	79	86	91	94	90	83	72
63-8-1.5	34	55	62	67	70	66	59	48	80-4-5.5	55	76	83	88	91	87	80	69
63-8-1.5	31	52	59	64	67	63	56	45	80-6-1.5	46	67	74	79	82	78	71	60
63-8-2	35	56	63	68	71	67	60	49	80-6-1.5	44	65	72	77	80	76	69	58
63-8-2	32	53	60	65	68	64	57	46	80-6-2	47	68	75	80	83	79	72	61
63-8-3	36	57	64	69	72	68	61	50	80-6-2	45	66	73	78	81	77	70	59
63-8-3	33	54	61	66	69	65	58	47	80-6-3	48	69	76	81	84	80	73	62
71-4-2	53	74	81	86	89	85	78	67	80-6-3	46	67	74	79	82	78	71	60

Acoustic features

☐ Values taken at inlet with maximum airflow. ☐ Values taken at outlet with maximum airflow.

Sound power Lw(A) spectrum in dB(A) via frequency band in Hz.

Model	63	125	250	500	1000	2000	4000	8000	Model	63	125	250	500	1000	2000	4000	8000
80-8-1	45	66	73	78	81	77	70	59	100-4-7,5	68	89	96	101	104	100	93	82
80-8-1	44	65	72	77	80	76	69	58	100-4-7,5	65	86	93	98	101	97	90	79
80-8-4	42	63	70	75	78	74	67	56	100-4-9	68	89	96	101	104	100	93	82
80-8-4	39	60	67	72	75	71	64	53	100-4-9	65	86	93	98	101	97	90	79
80-8-5,5	43	64	71	76	79	75	68	57	100-4-10	69	90	97	102	105	101	94	83
80-8-5,5	40	61	68	73	76	72	65	54	100-4-10	66	87	94	99	102	98	91	80
90-4-5,5	63	84	91	96	99	95	88	77	100-4-14	69	90	97	102	105	101	94	83
90-4-5,5	60	81	88	93	96	92	85	74	100-4-14	66	87	94	99	102	98	91	80
90-4-7,5	65	86	93	98	101	97	90	79	100-4-15	70	91	98	103	106	102	95	84
90-4-7,5	62	83	90	95	98	94	87	76	100-4-15	67	88	95	100	103	99	92	81
90-4-9	66	87	94	99	102	98	91	80	100-6-3	58	79	86	91	94	90	83	72
90-4-9	63	84	91	96	99	95	88	77	100-6-3	56	77	84	89	92	88	81	70
90-4-10	66	87	94	99	102	98	91	80	100-6-4	59	80	87	92	95	91	84	73
90-4-10	63	84	91	96	99	95	88	77	100-6-4	57	78	85	90	93	89	82	71
90-6-3	52	73	80	85	88	84	77	66	100-6-5,5	60	81	88	93	96	92	85	74
90-6-3	50	71	78	83	86	82	75	64	100-6-5,5	58	79	86	91	94	90	83	72
90-6-4	53	74	81	86	89	85	78	67	100-8-3	53	74	81	86	89	85	78	67
90-6-4	51	72	79	84	87	83	76	65	100-8-3	52	73	80	85	88	84	77	66
90-8-1	45	66	73	78	81	77	70	59	100-8-4	54	75	82	87	90	86	79	68
90-8-1	44	65	72	77	80	76	69	58	100-8-4	53	74	81	86	89	85	78	67
90-8-2	47	68	75	80	83	79	72	61	100-8-7,5	53	74	81	86	89	85	78	67
90-8-2	46	67	74	79	82	78	71	60	100-8-7,5	50	71	78	83	86	82	75	64
90-8-5,5	48	69	76	81	84	80	73	62	100-8-9	53	74	81	86	89	85	78	67
90-8-5,5	45	66	73	78	81	77	70	59	100-8-9	50	71	78	83	86	82	75	64
90-8-7,5	50	71	78	83	86	82	75	64	100-8-14	54	75	82	87	90	86	79	68
90-8-7,5	47	68	75	80	83	79	72	61	100-8-14	51	72	79	84	87	83	76	65
90-8-9	51	72	79	84	87	83	76	65	100-12-3	43	64	71	76	79	75	68	57
90-8-9	48	69	76	81	84	80	73	62	100-12-3	41	62	69	74	77	73	66	55
90-12-3	37	58	65	70	73	69	62	51	100-12-4	44	65	72	77	80	76	69	58
90-12-3	35	56	63	68	71	67	60	49	100-12-4	42	63	70	75	78	74	67	56
90-12-4	38	59	66	71	74	70	63	52	100-12-5,5	45	66	73	78	81	77	70	59
90-12-4	36	57	64	69	72	68	61	50	100-12-5,5	43	64	71	76	79	75	68	57

Dimensions in mm

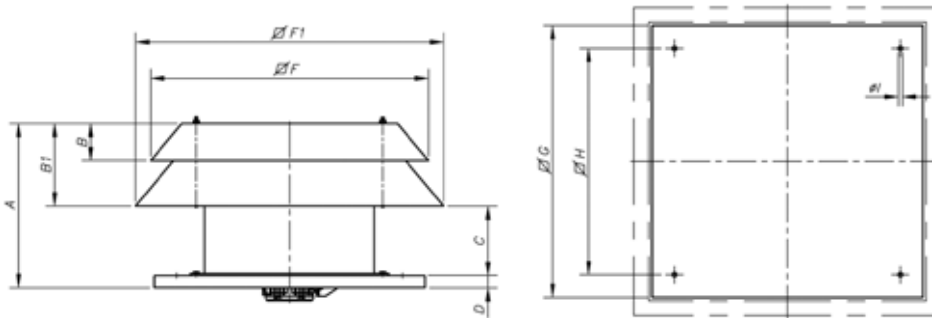

Model	A	B	B1	C	D	F	F1	G	H	ØI
HTMF-56	532	132	266	225	40	925	936	900	750	14
HTMF-63	577	141.5	311.5	225	40	1026	1058	1000	850	14
HTMF-71	661	156.5	351.5	270	40	1138	1180	1000	850	14
HTMF-80	721	176.5	401.5	270	50	1262	1313	1150	1000	14
HTMF-90	817	202	452	315	50	1425	1482	1150	1000	14
HTMF-100	957	212	492	415	50	1580	1642	1250	1100	14

Characteristic curves

Q = Airflow in m³/h, m³/s and cfm.

Pe = Static pressure in mm.w.c., Pa and inwg.

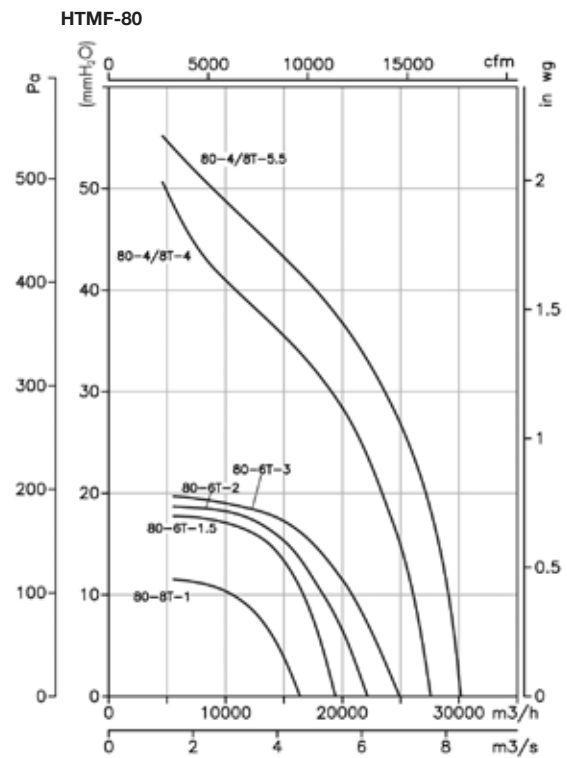
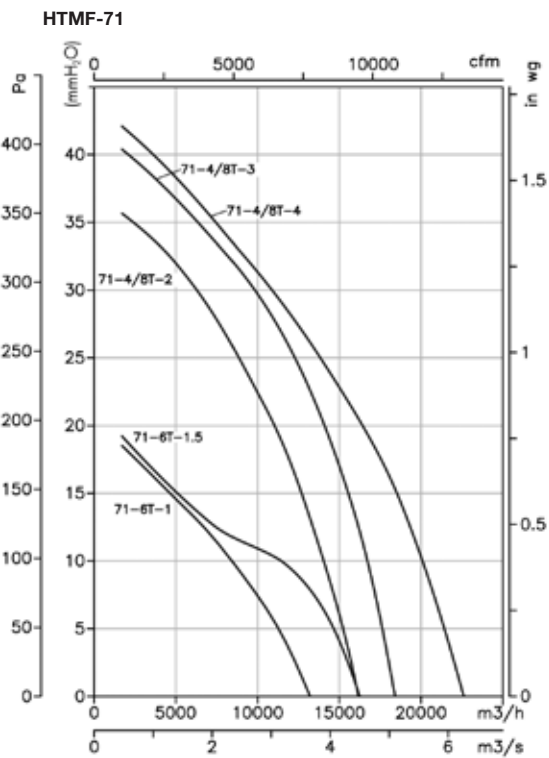
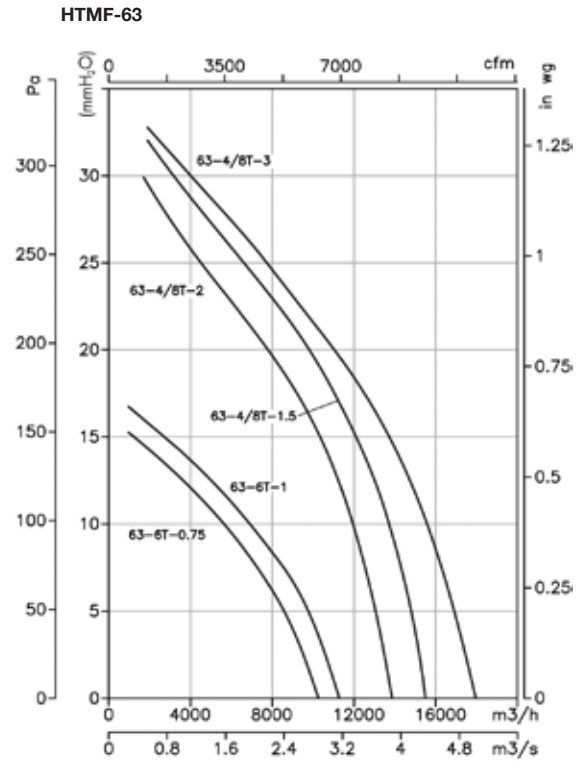
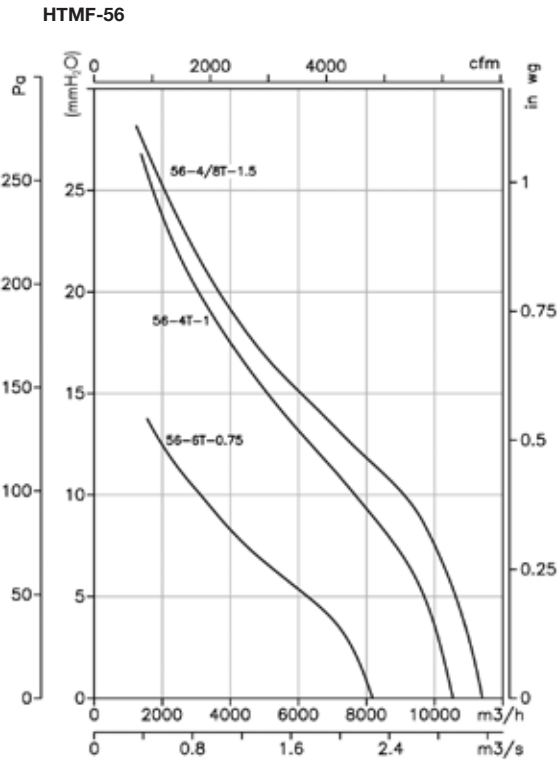

Characteristic curves

Q = Airflow in m³/h, m³/s and cfm.

Pe= Static pressure in mm.w.c., Pa and inwg.

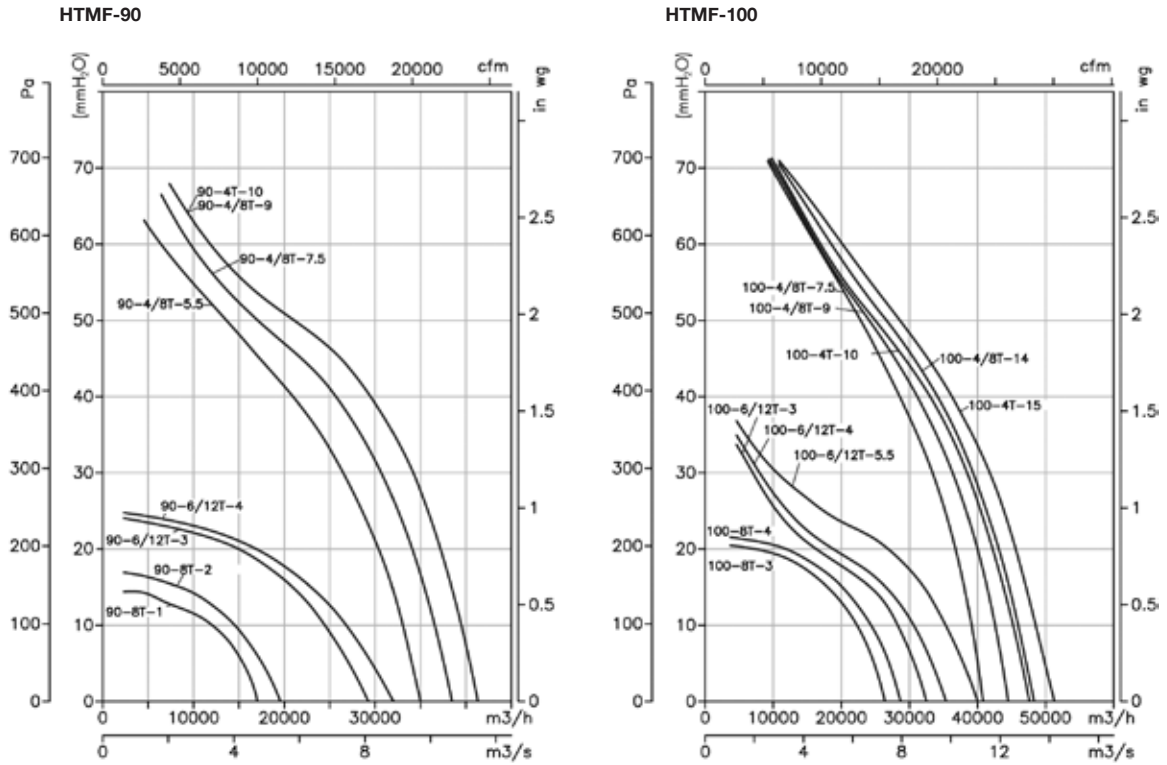

Validation of the sound pressure according to distance

The sound level may vary depending on the structure of the roof.

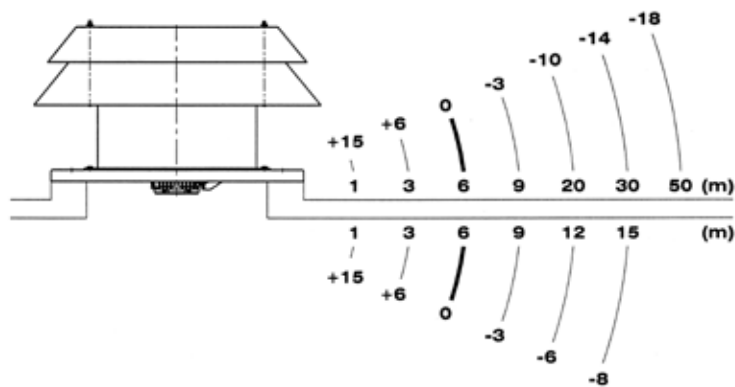

Accessories

See accessories section



CJBDT/CBDT



Double inlet and direct motor extraction units and centrifugal fans for working inside fire danger zones 400°C/2h and 300°C/2h, with possibility of single-phase motor



Double inlet and direct motor extraction units and centrifugal fans for working inside fire danger zones 400°C/2h, with possibility of single-phase motor

Fan:

- Galvanized sheet steel casing
- Impeller with forward-facing blades made from galvanised sheet steel
- Outside connecting box.
- Anti-vibration dampers (CJBDT)
- Approval according to Standard EN12101-3:2002, certificate no.: 370-CPD-0580



Motor:

- Class H motors, ongoing use S1 and emergency use S2, with ball bearings, IP55 protection, and one- or two- speed depending on the model.
- Single-phase 230V 50 Hz. and Three-phase 230/400V.50Hz. (up to 4CV) and 400/690V.-50Hz. (power over 4CV)
- Max. temperature of air for transport: S1 Service -20°C + 60°C for ongoing use, S2 Service 300°C/2h, 400°C/2h

Finish:

- Anticorrosive galvanized sheet steel.

On request:

- Fans with circular inlet
- Fans with vertical outlet



Outside connecting box and base stands



Single-phase motors, 400°C/2h

Order code

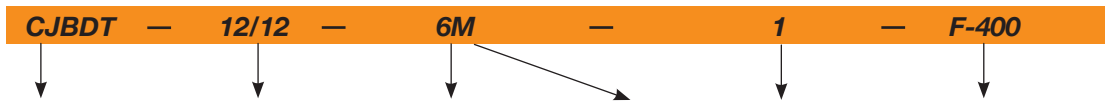

CJBDT: Double inlet and direct motor extraction units for working inside fire danger zones 400°C/2h and 300°C/2h, with possibility of single-phase motor

12/12: Turbine size

6M: Number of motor poles
 2=2900 r/min. 50 Hz
 4=1400 r/min. 50 Hz
 6=900 r/min. 50 Hz
 8=750 r/min. 50 Hz
 12=500 r/min. 50 Hz

M= Single-phase
T=Three-phase

1: Power motor (c.v.)

F-300 Officially approved, tested for 300°C/2h
F-400 Officially approved 400°C/2h

CBDT: Centrifugal double inlet and direct motor fans for working inside fire danger zones 400°C/2h and 300°C/2h, with possibility of single-phase motor

Technical characteristics

Model		Speed (r/min)	Maximum admissible current (A)			Power installed (kW)	Airflow maximum (m³/h)	Sound pressure level dB(A)		Approx. weight (Kg)	
			230V	400V	690V			CJBDT	CBDT	CJBDT	CBDT
CJBDT-9/9-4T	CBDT-9/9-4T	1420	2.90	1.70		0.55	3000	64	66	44	24
CJBDT-9/9-4/8T	CBDT-9/9-4/8T	1440 / 710		1.76 / 0.76		0.55 / 0.15	3000 / 1750	64 / 51	66 / 53	45	25
CJBDT-9/9-4M	CBDT-9/9-4M	1410	4.10			0.55	3000	64	66	44	23
CJBDT-9/9-6T	CBDT-9/9-6T	920	1.50	0.90		0.25	2100	60	61	42	22
CJBDT-9/9-6M	CBDT-9/9-6M	900	2.20			0.25	2100	60	61	42	21
CJBDT-10/10-4T	CBDT-10/10-4T	1420	2.90	1.70		0.55	3450	67	68	49	26
CJBDT-10/10-4/8T	CBDT-10/10-4/8T	1440 / 710		1.76 / 0.76		0.55 / 0.15	3450 / 1750	67 / 54	68 / 55	50	27
CJBDT-10/10-4M	CBDT-10/10-4M	1410	4.10			0.55	3450	67	68	49	25
CJBDT-10/10-6T	CBDT-10/10-6T	920	1.50	0.90		0.25	2250	63	64	47	24
CJBDT-10/10-6M	CBDT-10/10-6M	900	2.20			0.25	2250	63	64	47	23
CJBDT-12/12-6T-1	CBDT-12/12-6T-1	940	4.40	2.60		0.75	4800	64	65	69	37
CJBDT-12/12-6/12T-1	CBDT-12/12-6/12T-1	935 / 430		2.50 / 1.03		0.75 / 0.15	4800 / 2600	64 / 52	65 / 53	72	41
CJBDT-12/12-6M-1	CBDT-12/12-6M-1	920	5.80			0.75	4800	64	65	69	37
CJBDT-12/12-6T-1.5	CBDT-12/12-6T-1.5	945	6.40	3.70		1.10	6200	65	67	71	39
CJBDT-12/12-6/12T-1,5	CBDT-12/12-6/12T-1,5	940 / 450		3.30 / 1.20		1.10 / 0.18	6200 / 3250	65 / 53	67 / 55	75	44
CJBDT-12/12-6M-1,5	CBDT-12/12-6M-1,5	920	8.40			1.10	6200	65	67	71	39
CJBDT-15/15-6T	CBDT-15/15-6T	950	10.30	5.90		2.20	8250	67	68	110	68
CJBDT-15/15-6/12T	CBDT-15/15-6/12T	940 / 470		5.60 / 2.20		2.20 / 0.37	8250 / 4600	67 / 54	68 / 55	116	74
CJBDT-18/18-6T	CBDT-18/18-6T	970		11.00	6.35	4.00	11800	67	69	175	109
CJBDT-18/18-6/12T	CBDT-18/18-6/12T	970 / 480		11.30 / 4.20		4.00 / 0.65	11800 / 6600	67 / 54	69 / 56	183	117
CJBDT-20/20-6T	CBDT-20/20-6T	970		14.00		5.50	14300	68	70	247	151
CJBDT-20/20-6/12T	CBDT-20/20-6/12T	970 / 480		13.70 / 5.60		5.50 / 1.00	14300 / 9700	68 / 55	70 / 57	255	159
CJBDT-22/22-6T	CBDT-22/22-6T	960		18.40	10.60	7.50	18050	69	71	309	190
CJBDT-22/22-6/12T	CBDT-22/22-6/12T	970 / 480		19.00 / 8.00		7.50 / 1.40	18050 / 11800	69 / 56	71 / 58	319	200



Erp. BEP (best efficiency point) characteristics

<(°)	Angle of inclination of the blades, in degrees	SR	Specific ratio
PN	Motor's nominal power in kW	ηe[%]	Efficiency
MC	Measurement category	N	Efficiency grade
EC	Efficiency category	[kW]	Input power
S	Static	[m³/h]	Airflow
T	Total	[mmH ₂ O]	Static or total pressure (According to EC)
VSD	Variable-speed drive	[RPM]	Speed

	MC	EC	VSD	SR	ηe[%]	N	(kW)	(m³/h)	(mmH ₂ O)	(RPM)
CBDT-9/9-4T	A	S	NO	1.00	26.2%	34.0	0.588	1568	36.26	1453
CBDT-9/9-4/8T	A	S	NO	1.00	26.0%	33.7	0.596	1580	36.14	1465
CBDT-9/9-4M	A	S	NO	1.00	25.7%	33.4	0.598	1561	36.32	1447
CBDT-9/9-6T	A	S	NO	1.00	25.9%	37.2	0.165	1112	14.14	953
CBDT-9/9-6M	A	S	NO	1.00	25.4%	36.6	0.167	1098	14.23	942
CBDT-10/10-4T	A	S	NO	1.00	35.2%	42.1	0.808	2097	47.28	1437
CBDT-10/10-4/8T	A	S	NO	1.00	35.1%	42.0	0.814	2120	47.03	1453
CBDT-10/10-4M	A	S	NO	1.00	35.0%	41.9	0.811	2085	47.40	1429
CBDT-10/10-6T	A	S	NO	1.00	32.1%	42.5	0.225	1393	19.03	938
CBDT-10/10-6M	A	S	NO	1.00	31.7%	42.1	0.226	1370	19.22	923
CBDT-12/12-6T-1	A	S	NO	1.00	34.9%	42.1	0.728	3087	30.42	966
CBDT-12/12-6/12T-1	A	S	NO	1.00	34.8%	42.0	0.727	3078	30.45	963
CBDT-12/12-6M-1	A	S	NO	1.00	34.7%	41.9	0.723	3051	30.53	955
CBDT-12/12-6T-1.5	A	S	NO	1.00	35.4%	42.2	0.877	3723	30.11	973
CBDT-12/12-6/12T-1.5	A	S	NO	1.00	35.4%	42.1	0.877	3714	30.14	970
CBDT-12/12-6M-1.5	A	S	NO	1.00	35.3%	42.1	0.870	3676	30.28	960
CBDT-15/15-6T	A	S	NO	1.00	39.5%	43.9	2.101	5911	51.34	967
CBDT-15/15-6/12T	A	S	NO	1.00	38.7%	43.0	2.129	5870	51.37	960
CBDT-18/18-6T	A	S	NO	1.01	39.8%	42.1	4.421	9715	66.29	979
CBDT-18/18-6/12T	A	S	NO	1.01	39.6%	41.9	4.429	9673	66.39	974
CBDT-20/20-6T	A	S	NO	1.01	44.7%	46.6	5.208	9157	92.71	984
CBDT-20/20-6/12T	A	S	NO	1.01	43.8%	45.7	5.298	9126	92.73	980
CBDT-22/22-6T	A	S	NO	1.01	47.1%	47.8	7.827	13228	102.71	969
CBDT-22/22-6/12T	A	S	NO	1.01	46.1%	46.8	8.035	13333	102.54	977

Acoustic features

The specified values are determined according to free field measurements of pressure and sound levels in dB(A) at an equivalent distance of twice the fan's span plus the impeller's diameter, with a minimum of 1.5 m.

Sound power Lw(A) spectrum in dB(A) via frequency band in Hz.

CBDT Model	63	125	250	500	1000	2000	4000	8000	CJBDT Model	63	125	250	500	1000	2000	4000	8000
9/9-4	46	56	64	68	73	72	69	61	9/9-4	51	66	70	69	68	65	65	55
9/9-6	43	54	59	66	67	67	62	56	9/9-6	47	62	66	65	64	61	61	51
9/9-8	34	45	51	57	60	59	55	48	9/9-8	44	51	57	57	54	50	53	48
10/10-4	48	58	66	70	75	74	71	63	10/10-4	54	69	73	72	71	68	68	58
10/10-6	46	57	62	69	70	70	65	59	10/10-6	50	65	69	68	67	64	64	54
10/10-8	36	47	53	59	62	61	57	50	10/10-8	47	54	60	60	57	53	56	51
12/12-6-1	47	58	63	70	71	71	66	60	12/12-6-1	51	66	70	69	68	65	65	55
12/12-6-1,5	49	60	65	72	73	73	68	62	12/12-6-1,5	52	67	71	70	69	66	66	56
12/12-12-1	34	45	51	57	60	59	55	48	12/12-12-1	45	52	58	58	55	51	54	49
12/12-12-1,5	46	53	59	59	56	52	55	50	12/12-12-1,5	46	53	59	59	56	52	55	50
15/15-6	63	72	74	76	71	70	64	55	15/15-6	63	72	74	76	71	70	64	55
15/15-12	51	54	63	60	58	60	60	48	15/15-12	51	54	63	60	58	60	60	48
18/18-6	64	74	76	78	73	72	66	57	18/18-6	64	74	76	78	73	72	66	57
18/18-12	53	56	65	62	60	62	62	50	18/18-12	53	56	65	62	60	62	62	50
20/20-6	67	77	79	80	76	74	69	60	20/20-6	67	77	79	80	76	74	69	60
20/20-12	55	59	68	65	63	65	64	53	20/20-12	55	59	68	65	63	65	64	53
22/22-6	69	79	81	83	78	77	71	62	22/22-6	69	79	81	83	78	77	71	62
22/22-12	58	61	70	67	65	67	67	55	22/22-12	58	61	70	67	65	67	67	55

Dimensions in mm

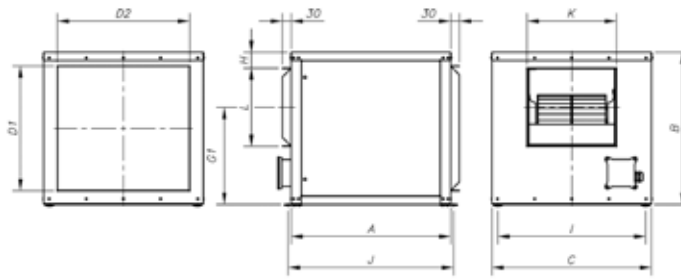

	A	B	C	D1	D2	G1	H	I	J	K	L
CJBDT-9/9	550	522	550	428	456	333,5	54,5	509	570	308	268
CJBDT-10/10	600	575	600	480	505	361,5	65,5	559	620	334	296
CJBDT-12/12	650	650	700	555	605	418	57,5	659	670	395	349
CJBDT-15/15	755	755	800	660	705	485	64	759	775	478	412
CJBDT-18/18	1000	900	1000	804	904	585	69,5	934	1041	550	491
CJBDT-20/20	1200	1175	1100	1070	1000	701	167,5	1040	1247	610	613
CJBDT-22/22	1280	1250	1250	1154	1154	739,5	158,8	1190	1327	664	704

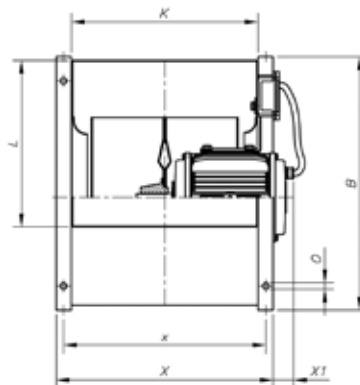
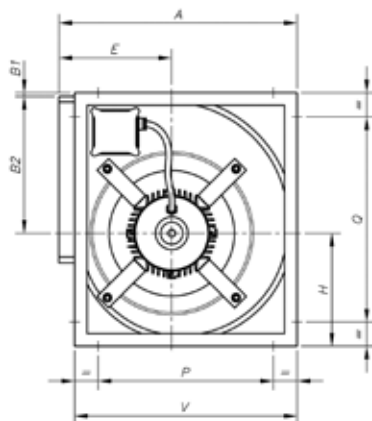

Terminal box situation

CBDT-9/9
10/10
12/12
15/15

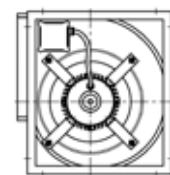

CBDT-18/18
20/20
22/22

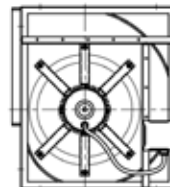

	A	B	B1	B2	E	H	K	L	P	Q	V	X	X1	x	O
CBDT-9/9	390	402	1,5	218	183	181	300	263	280	280	358	360	49	332	9x17
CBDT-10/10	430	448	2	246	202	204	326	292	326	326	398	388	33	360	9x17
CBDT-12/12	501	534	4	290	230	239,5	387	342	384	384	470	448	57	420	9x17
CBDT-15/15	584	630	-	348	265	280	473	405	460	460	550	535	58	507	9x17
CBDT-18/18	694	756	4	415	323	336	540	482	553	608	665	600	85	570	9x17
CBDT-20/20	839	935	6	523	372	406	602	604	595	735	795	682	58	642	12
CBDT-22/22	907	1019	6	571	399	442	655	695	663	819	863	735	105	695	12

Characteristic curves

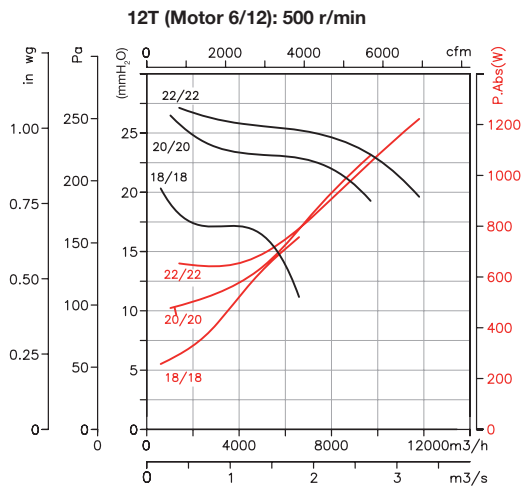
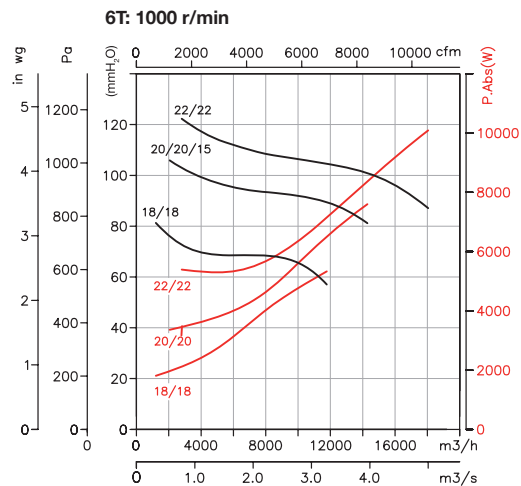
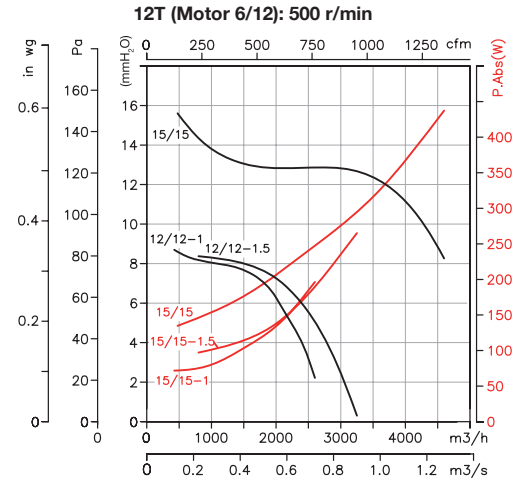
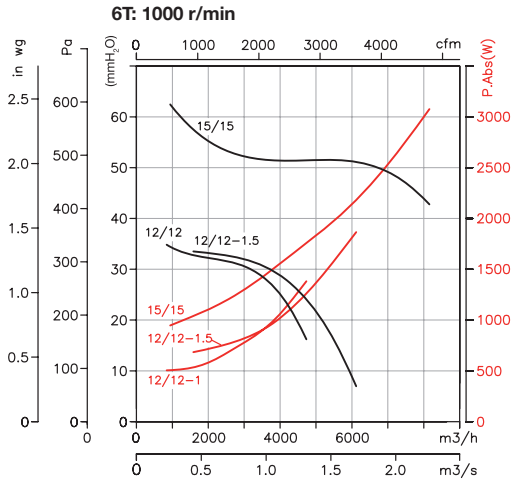
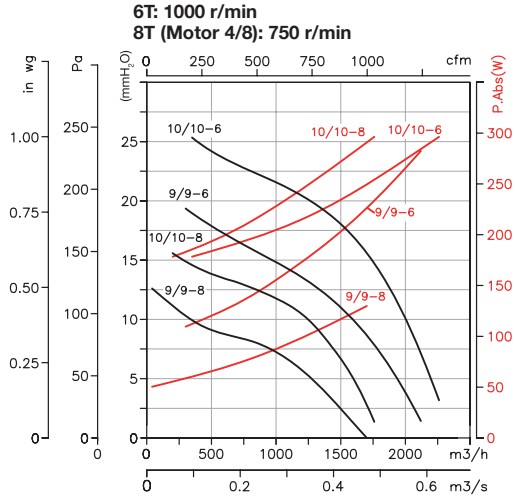
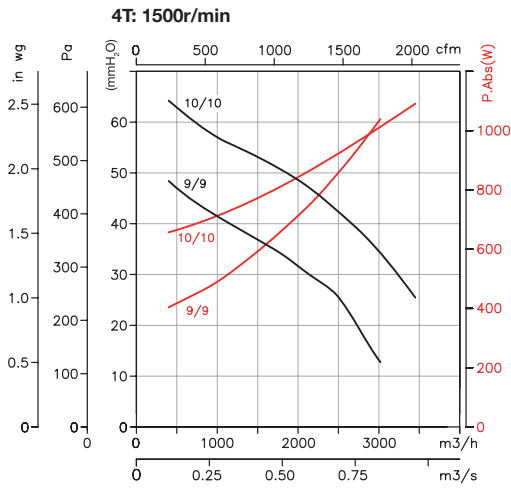

Accessories

See accessories section



TCR

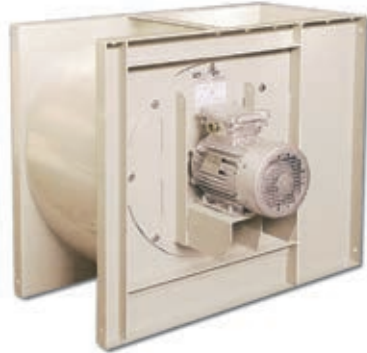

400°C/2h and 300°C/2h centrifugal fans with backward-curved impeller.

Robust centrifugal medium-pressure single-inlet fans to work inside fire danger zones at 400°C/2h, fitted with impellers backward-curved blades.

- Fan:
- Steel sheet casing
 - Impeller with backward-curved blades made from robust sheet steel and heat-resistant paint
 - Approval according to Standard EN-12101-3-2002, certificate no.: 0370-CPD-0384

- Motor:
- Class H motors, ongoing use S1 and emergency use S2, with ball bearings and IP55 protection
 - Three-phase 230/400V.-50Hz. (up to 4CV.) and 400/690V.-50Hz. (power over 4CV.)
 - Max. temperature of air for transport: S1 Service -20°C+ 120°C for ongoing use, S2 Service 300°C/2h, 400°C/2h

- Finish:
- Anticorrosive finish in polyester resin, polymerised at 190°C, after alkaline degreasing and phosphate-free pre-treatment.

- On request:
- Fans with 200°C/2h one- or two-speed motor



High-performance and robust backward-curved impeller.

Order code

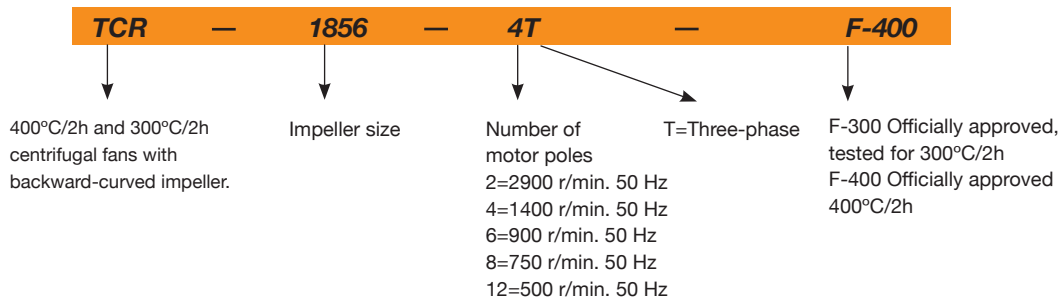

Positions

LG 270 standard supply



Technical characteristics

Model	Speed (r/min)	Maximum admissible current (A)			Power installed (kW)	Airflow maximum (m³/h)	Sound pressure level dB(A)	Approx. weight (Kg)
		230V	400V	690V				
TCR-1240-4T	1430	3.80	2.20		0.75	5800	71	76
TCR-1445-4T	1420	4.70	2.70		1.10	8030	72	98
TCR-1650-4T	1425	6.60	3.80		1.50	10500	74	118
TCR-1650-6T	940	4.40	2.60		0.75	7410	64	118
TCR-1856-4T	1430	11.40	6.60		3.00	15150	79	158
TCR-1856-6T	945	6.40	3.70		1.10	10050	70	150
TCR-2063-4T	1430		11.50	6.64	5.50	24450	80	257
TCR-2063-6T	945	7.40	4.30		1.50	16100	71	212
TCR-2271-4T	1455		23.00	13.28	11.00	34610	85	380
TCR-2271-6T	945	15.00	8.70		3.00	22750	76	313



Erp. BEP (best efficiency point) characteristics

<(°)	Angle of inclination of the blades, in degrees	SR	Specific ratio
PN	Motor's nominal power in kW	ηe[%]	Efficiency
MC	Measurement category	N	Efficiency grade
EC	Efficiency category	[kW]	Input power
S	Static	[m³/h]	Airflow
T	Total	[mmH²O]	Static or total pressure (According to EC)
VSD	Variable-speed drive	[RPM]	Speed

Modelo	MC	EC	VSD	SR	ηe[%]	N	(kW)	(m³/h)	(mmH₂O)	(RPM)
TCR-1240-4T	A	S	NO	1.00	45.7%	58.5	0.608	2924	34.89	1461
TCR-1445-4T	A	S	NO	1.01	50.2%	60.4	1.065	3883	50.49	1442
TCR-1650-4T	A	S	NO	1.01	50.7%	58.7	1.759	5378	60.90	1437
TCR-1650-6T	A	S	NO	1.00	45.5%	58.3	0.592	4109	24.02	969
TCR-1856-4T	A	S	NO	1.01	54.3%	59.4	3.277	8342	78.29	1440
TCR-1856-6T	A	S	NO	1.00	48.4%	58.7	1.054	5632	33.24	963
TCR-2063-4T	B	T	NO	1.01	70.5%	72.4	6.537	13932	121.38	1432
TCR-2063-6T	A	S	NO	1.00	56.7%	64.2	1.930	9620	41.77	948
TCR-2271-4T	B	T	NO	1.01	69.9%	69.6	13.078	22380	149.81	1455
TCR-2271-6T	B	T	NO	1.01	57.4%	61.5	4.069	15016	57.11	945

Acoustic features

The specified values are determined according to free field measurements of pressure and sound levels in dB(A) at an equivalent distance of twice the fan's span plus the turbine's diameter, with a minimum of 1.5 m.

Sound power Lw(A) spectrum in dB(A) via frequency band in Hz.

Model	63	125	250	500	1000	2000	4000	8000	Model	63	125	250	500	1000	2000	4000	8000
1240	56	70	76	79	79	80	70	59	1856-6	61	69	81	83	80	81	71	60
1445	59	72	78	83	80	83	78	64	2063-4	80	85	91	93	91	88	81	73
1650-4	64	74	82	84	83	85	76	66	2063-6	69	70	82	82	81	83	73	63
1650-6	53	65	72	77	73	69	62	54	2271-4	83	84	93	96	98	99	95	82
1856-4	69	78	91	87	90	91	85	71	2271-6	73	73	87	86	90	90	79	68

Dimensions in mm

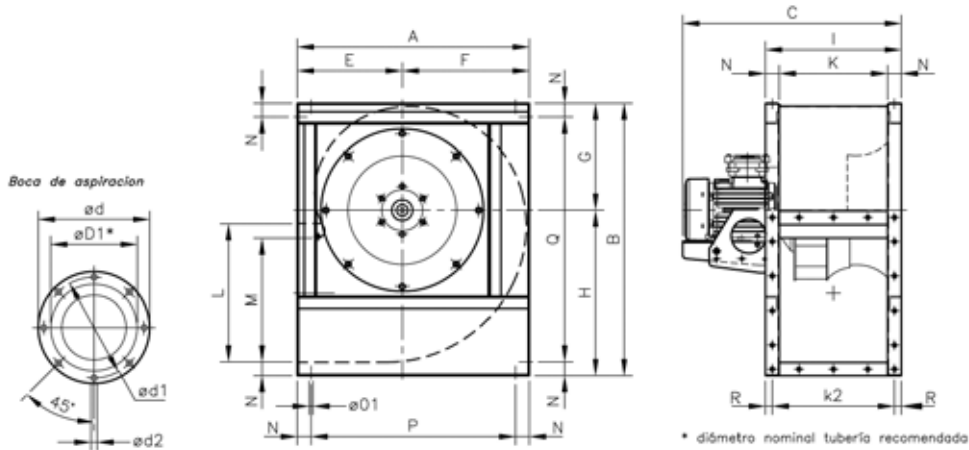

Model	A	B	C	ØD1*	Ød	Ød1	Ød2	E	F	G	H	M	N	Ø01	P	Q	R
1240-4T	673	790	634	400	472	444	M.8	305	368	310	480	358.5	40	11	593	710	20
1445-4T	765	880	727	450	522	494	M.8	350	415	339	541	407	45	11	675	790	20
1650-4T	832	970	770.5	500	582	555	M.10	375	457	378	592	445	45	13	742	880	20
1650-6T	832	970	770.5	500	582	555	M.10	375	457	378	592	445	45	13	742	880	20
1856-4T	925	1084	857.5	560	645	615	M.10	415	510	424	660	493	50	13	825	984	25
1856-6T	925	1084	828	560	645	615	M.10	415	510	424	660	493	50	13	825	984	25
2063-4T	1037	1218	955	630	720	688	M.10	465	572	477	741	530	60	13	917	1098	30
2063-6T	1037	1218	932	630	720	688	M.10	465	572	477	741	530	60	13	917	1098	30
2271-4T	1173	1375	1149	710	800	768	M.12	525	648	538	837	603.5	65	13	1043	1245	32.5
2271-6T	1173	1375	1112	710	800	768	M.12	525	648	538	837	603.5	65	13	1043	1245	32.5

Dimensions in mm

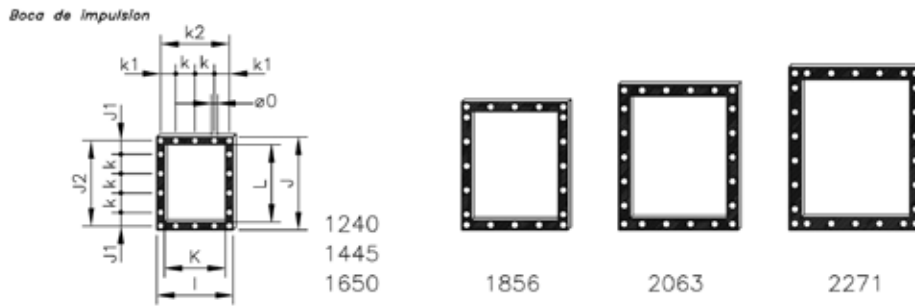

Model	I	J	J1	J2	K	k	k1	k2	L	Ø0
1240	395	480	70	440	315	100	77.5	355	400	11
1445	445	540	99	498	355	100	102.5	405	450	11
1650	490	590	87.5	550	400	125	100	450	500	13
1856	550	660	55	610	450	125	125	500	560	13
2063	620	750	95	690	500	125	92.5	560	630	13
2271	690	840	75	775	560	125	62.5	625	710	13

Characteristic curves

Q = Airflow in m³/h, m³/s and cfm.

Pe = Static pressure in mm.w.c., Pa and inwg.

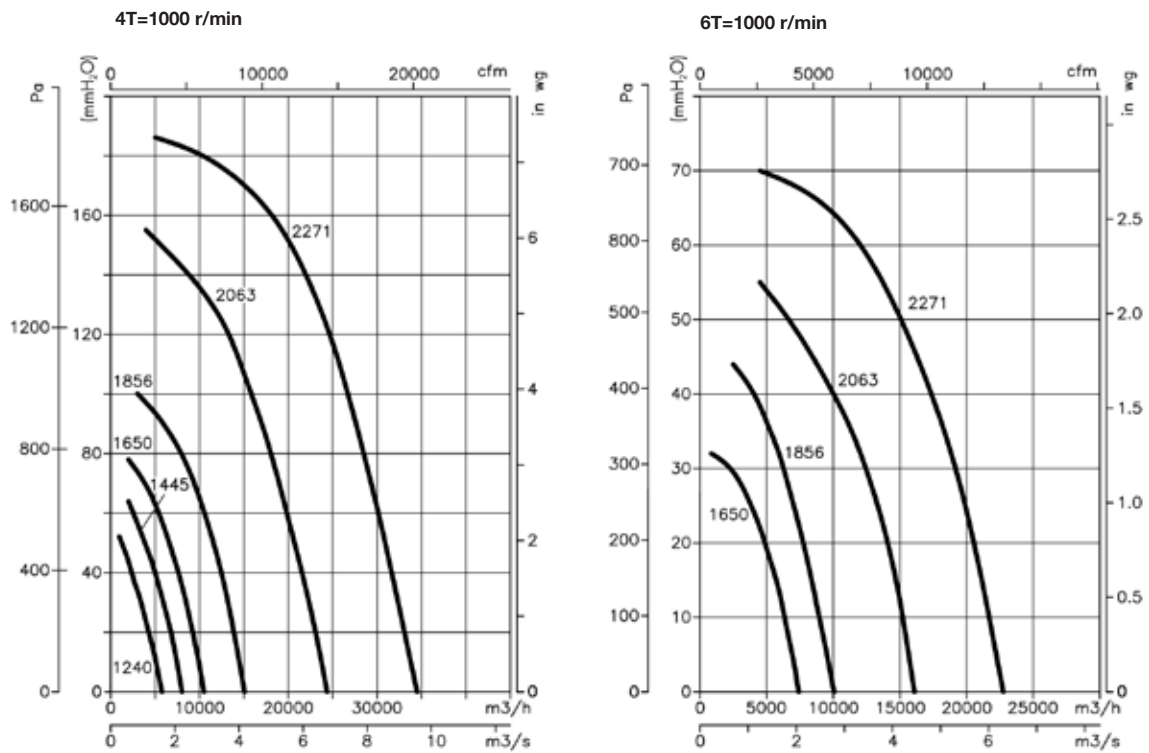

Accessories

See accessories section



CTMP



High-performance multi-blade impeller and robust centres

400°C/2h and 300°C/2h centrifugal fans with multi-blade impeller

Centrifugal medium-pressure single-inlet fans to work inside fire danger zones at 400°C/2h, fitted with sheet steel casing and impeller.

Fan:

- Steel sheet casing
- Impeller with forward-facing blades made from galvanised sheet steel
- Approval according to Standard EN-12101-3-2002, certificate no.: 0370-CPD-0397

Motor:

- Class H motors, ongoing use S1 and emergency use S2, with ball bearings and IP55 protection
- Three-phase 230/400V.-50Hz. (up to 4CV.) and 400/690V.-50Hz. (power over 4CV.)
- Max. temperature of air for transport: S1 Service -20°C+ 120°C for ongoing use, S2 Service 300°C/2h, 400°C/2h

Finish:

- Anticorrosive finish in polyester resin, polymerised at 190°C, after alkaline degreasing and phosphate-free pre-treatment.

On request:

- Fans with two-speed motor.



Order Code

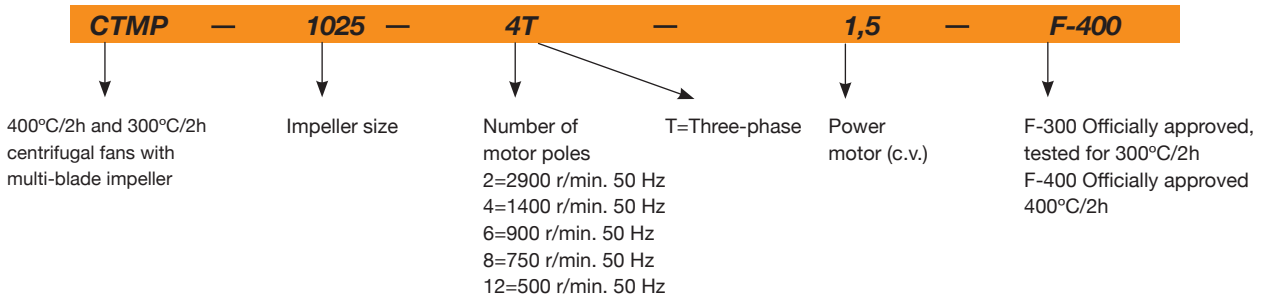

Technical characteristics

Model	Speed (r/min)	Maximum admissible current (A)			Power installed (kW)	Airflow maximum (m³/h)	Sound pressure level dB(A)	Approx. weight (Kg)
		230V	400V	690V				
CTMP-922-4T	1430	3.80	2.20		0.75	2450	66	30
CTMP-1025-4T-1.5	1420	4.70	2.70		1.10	3385	70	36
CTMP-1025-4T-2	1425	6.60	3.80		1.50	3650	72	38
CTMP-1128-4T-3	1435	9.20	5.30		2.20	5005	74	47
CTMP-1128-4T-4	1430	11.40	6.60		3.00	5450	75	51
CTMP-1128-6T	940	4.40	2.60		0.75	3300	60	41
CTMP-1231-4T-3	1435	9.20	5.30		2.20	4740	73	54
CTMP-1231-4T-4	1430	11.40	6.60		3.00	5910	75	59
CTMP-1231-4T-5.5	1440		8.40	4.85	4.00	6850	77	69
CTMP-1231-6T	945	7.40	4.30		1.50	5115	64	55
CTMP-1435-6T	950	10.30	5.90		2.20	6400	68	70
CTMP-1640-6T	950	10.30	5.90		2.20	8105	71	89
CTMP-1845-6T	950	10.30	5.90		2.20	7500	77	98
CTMP-2050-6T	970		11.00	6.35	4.00	11000	79	152



Erp. BEP (best efficiency point) characteristics

<(°)	Angle of inclination of the blades, in degrees	SR	Specific ratio
PN	Motor's nominal power in kW	ηe[%]	Efficiency
MC	Measurement category	N	Efficiency grade
EC	Efficiency category	[kW]	Input power
S	Static	[m³/h]	Airflow
T	Total	[mmH²O]	Static or total pressure (According to EC)
VSD	Variable-speed drive	[RPM]	Speed

Modelo	MC	EC	VSD	SR	ηe[%]	N	(kW)	(m³/h)	(mmH₂O)	(RPM)
CTMP-922-4T	A	S	NO	1.00	34.3%	43.7	0.326	1187	34.59	1479
CTMP-1025-4T-1.5	A	S	NO	1.01	35.5%	43.5	0.553	1501	48.06	1470
CTMP-1025-4T-2	A	S	NO	1.01	35.9%	43.8	0.572	1541	48.88	1479
CTMP-1128-4T-3	A	S	NO	1.01	37.4%	43.5	1.086	2303	64.68	1475
CTMP-1128-4T-4	A	S	NO	1.01	40.2%	46.3	1.059	2370	65.85	1480
CTMP-1128-6T	A	S	NO	1.00	33.1%	42.1	0.386	1622	28.94	980
CTMP-1231-4T-3	A	S	NO	1.01	38.5%	43.5	1.606	2927	77.43	1463
CTMP-1231-4T-4	A	S	NO	1.01	38.1%	42.9	1.746	3143	77.62	1468
CTMP-1231-4T-5.5	A	S	NO	1.01	39.0%	43.8	1.750	3120	80.29	1479
CTMP-1231-6T	A	S	NO	1.00	35.5%	43.1	0.624	2332	34.85	983
CTMP-1435-6T	A	S	NO	1.01	37.2%	43.6	0.964	3441	38.22	983
CTMP-1640-6T	A	S	NO	1.01	41.1%	46.5	1.388	3946	53.00	976
CTMP-1845-6T	A	S	NO	1.01	44.2%	48.3	2.202	5546	64.33	962
CTMP-2050-6T	A	S	NO	1.01	33.3%	35.6	4.370	6929	77.00	975

Acoustic features

The specified values are determined according to free field measurements of pressure and sound levels in dB(A) at an equivalent distance of twice the fan's span plus the turbine's diameter, with a minimum of 1.5 m.

Sound power Lw(A) spectrum in dB(A) via frequency band in Hz.

Model	63	125	250	500	1000	2000	4000	8000	Model	63	125	250	500	1000	2000	4000	8000
922	41	51	62	69	73	70	68	61	1231-4-4	53	62	73	80	84	82	80	73
1025-4-1,5	45	55	66	73	77	74	72	65	1231-4-5,5	55	64	75	82	86	84	82	75
1025-4-2	47	57	68	75	79	76	74	67	1231-6	42	51	62	69	73	71	69	62
1128-4-3	49	59	70	77	81	78	76	69	1435	46	55	66	73	77	75	73	66
1128-4-4	50	60	71	78	82	79	77	70	1640	49	58	69	76	80	78	76	69
1128-6	35	45	56	63	67	64	62	55	1845	56	66	77	84	88	86	84	76
1231-4-3	51	60	71	78	82	80	78	71	2050	58	68	79	86	90	88	86	78

Dimensions in mm

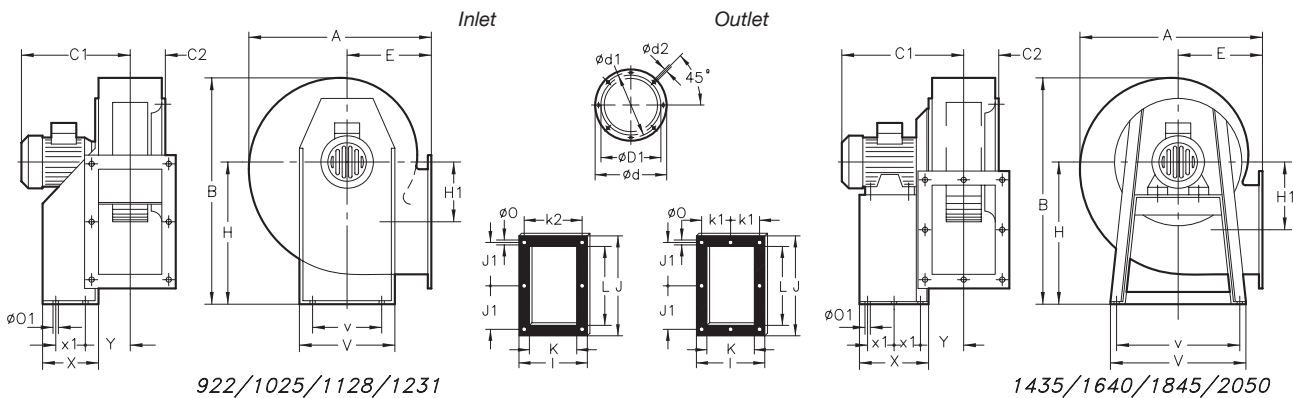

922/1025/1128/1231

1435/1640/1845/2050

Model	A	B	C1	C2	ØD1*	Ød	Ød1	Ød2	E	H	H1	I	J	J1	K	k1	k2	L	Ø0	Ø01	V	v	X	x1	Y
922	388.5	455	344	73.5	224	278	256	M.8	180	280	134	204	282.5	128	140	-	180	215	9.5	10.5	290	220	114	50	105
1025	427	503	356.5	86	250	305	282	M.8	197	310	144	229	312.5	145	165	-	205	250	9.5	12.5	315	228	134	74	115.5
1128-4T	472	553	439	93.5	280	348	320	M.8	216	340	152	244	364	170	180	-	220	296.5	9.5	12.5	348	245	144	95	122.5
1128-6T	472	553	364	93.5	280	348	320	M.8	216	340	152	244	364	170	180	-	220	296.5	9.5	12.5	348	245	144	95	122.5
1231-3	526	630	449	103.5	315	382	354	M.8	238	390	179.5	264	382.5	180	200	-	240	320	11.5	13	382	322	183	140	126
1231-4	526	630	449	103.5	315	382	354	M.8	238	390	179.5	264	382.5	180	200	-	240	320	11.5	13	382	322	183	140	126
1231-5.5	526	630	449	103.5	315	382	354	M.8	238	390	179.5	264	382.5	180	200	-	240	320	11.5	13	382	322	183	140	126
1231-6T	526	630	449	103.5	315	382	354	M.8	238	390	179.5	264	382.5	180	200	-	240	320	11.5	13	382	322	183	140	126
1435-6T	573.5	715	463	118	355	422	394	M.8	250	445	242.5	292	342.5	159	228	133	-	280	11.5	13	456	420	333	136.5	150
1640-6T	634	799	475	130	400	464	438	M.8	270	495	271	336	404	185	250	150	-	321	11.5	13	500	460	327	133.5	162.5
1845-6T	711	901	492	147	450	515	485	M.8	302	560	305	370	444	202	284	164	-	361	11.5	13	538	502	340	140	179.5
2050-6T	797	987	574.5	162.5	500	565	535	M.10	345	610	313	411	544	250	315	182.5	-	451	11.5	13	635	615	435	188	196

* Recommended nominal diameter for duct.

Characteristic curves

Q = Airflow in m³/h, m³/s and cfm.

Pe = Static pressure in mm.w.c., Pa and inwg.

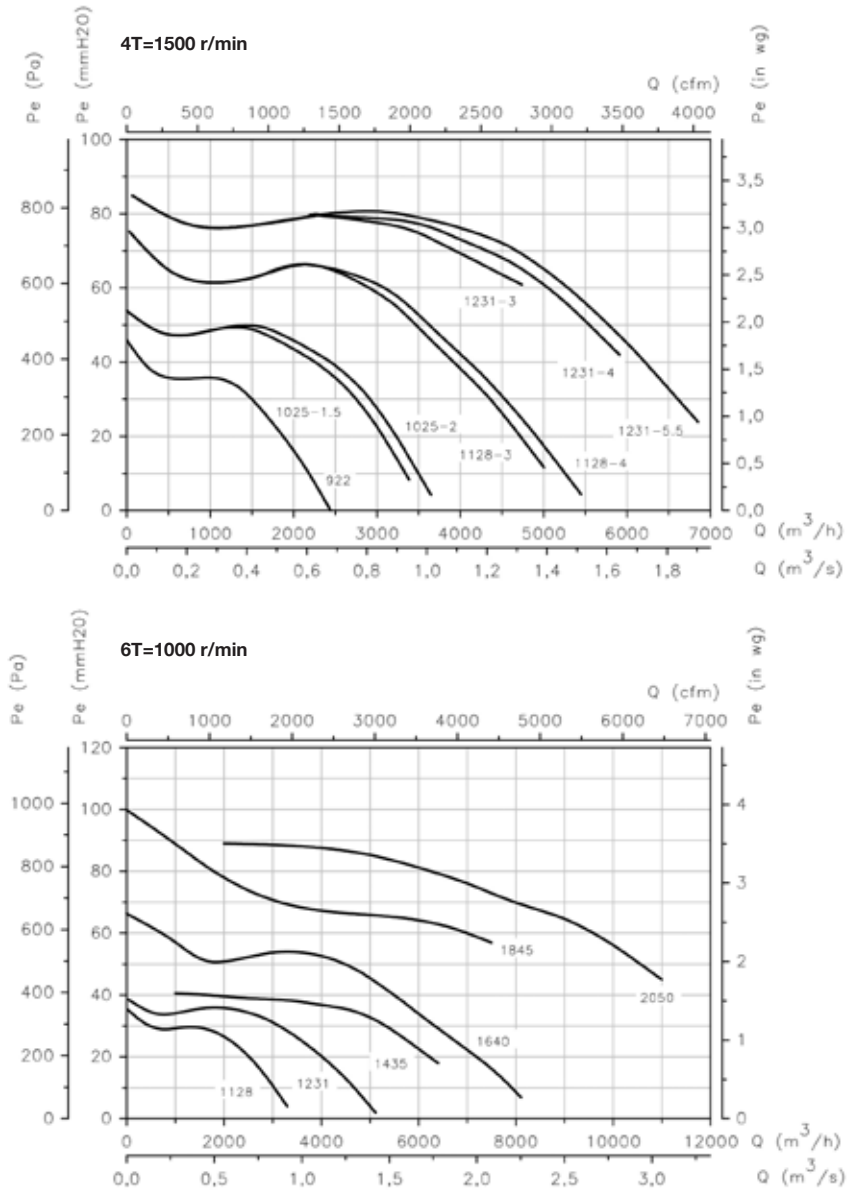

Positions

LG 270 standard supply
 LG 180 and RD 180 positions on request and with special fixing measures.



Accessories

See accessories section





400°C/2h and 300°C/2h extraction units with exchangeable hatches

Extraction units, with sandwich panel, to work inside fire danger zones at 400°C/2h, with soundproofed box.

Fan:

- Galvanised sheet steel structure with thermal insulation and soundproofing.
- Impeller with backward-curved blades made from sheet steel
- Exchangeable hatches for outlet on either side.
- Standard models supplied with rectangular outlet, with the TAC accessory, which can be changed for a circular outlet.
- Approval according to Standard EN-12101-3-2002, certificate no.: 0370-CPD-0398
- Linear air circulation



Built with sandwich panels to reduce noise irradiation

Motor:

- Class H motors, ongoing use S1 and emergency use S2, with ball bearings, IP55 protection, and one- or two- speed depending on the model.
- Three-phase 230/400V.-50Hz. (up to 4CV.) and 400/690V.-50Hz. (power over 4CV.)
- Max. temperature of air for transport: S1 Service -20°C+ 40°C for ongoing use, S2 Service 300°C/2h, 400°C/2h

Finish:

- Anticorrosive galvanized sheet steel.

On request:

- Fans with two-speed motor.
- Special version to work in a vertical position

Order Code

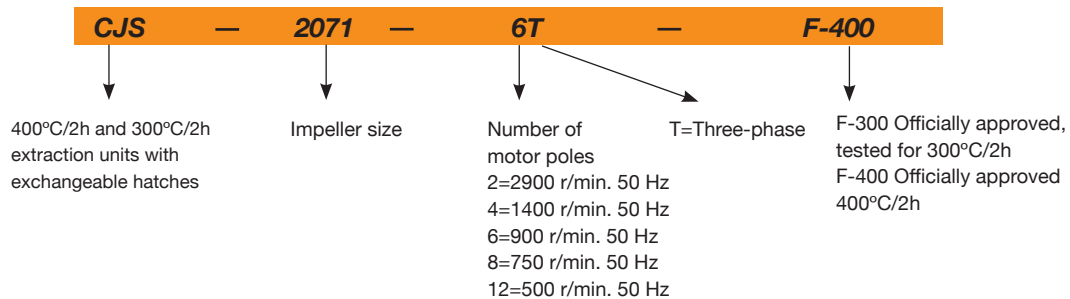

Technical characteristics

Model	Speed (r/min)	Maximum admissible current (A)			Power installed (kW)	Airflow maximum (m³/h)	Sound pressure level dB(A)	Approx. weight (Kg)
		230V	400V	690V				
CJS-1240-6T	930	1.90	1.90		0.55	2750	59	87
CJS-1850-4T	1425	6.60	3.80		1.50	6700	70	87
CJS-1850-4/8T	1415/715		3.60 / 1.50		1.50/0.30	6700/3350	70 / 55	92
CJS-1850-6T	930	3.30	1.90		0.55	4000	60	85
CJS-2056-4T	1435	9.20	5.30		2.20	9500	72	133
CJS-2056-4/8T	1415/715		5.20 / 1.90		2.20/0.45	9500/4750	72 / 57	146
CJS-2056-6T	940	4.40	2.60		0.75	6500	62	128
CJS-2263-4T	1430		11.50	6.64	5.50	17400	74	196
CJS-2263-4/8T	1455/725		12.80 / 4.60		5.50/1.10	17400/8700	74 / 59	215
CJS-2263-6T	945	6.40	3.70		1.10	9000	64	139
CJS-2071-4T	1455		23.00	13.28	11.00	25000	83	285
CJS-2071-4/8T	1470/725		23.20 / 8.70		11.00/2.80	25000/12500	83 / 68	285
CJS-2071-6T-3	950	10.30	5.90		2.20	12500	68	156
CJS-2071-6T-5.5	970		11.00	6.35	4.00	16000	70	251
CJS-2880-6T	970		11.00	6.35	4.00	17100	71	249



Erp. BEP (best efficiency point) characteristics

<(°)	Angle of inclination of the blades, in degrees	SR	Specific ratio
PN	Motor's nominal power in kW	ηe[%]	Efficiency
MC	Measurement category	N	Efficiency grade
EC	Efficiency category	[kW]	Input power
S	Static	[m³/h]	Airflow
T	Total	[mmH²O]	Static or total pressure (According to EC)
VSD	Variable-speed drive	[RPM]	Speed

Modelo	MC	EC	VSD	SR	ηe[%]	N	(kW)	(m³/h)	(mmH₂O)	(RPM)
CJS-1240-6T	C	S	NO	1.00	44.5%	62.1	0.203	2636	12.58	983
CJS-1850-4T	C	S	NO	1.01	58.5%	67.2	1.317	5311	53.29	1435
CJS-1850-4/8T	C	S	NO	1.01	58.5%	67.2	1.317	5311	53.29	1427
CJS-1850-6T	C	S	NO	1.00	48.4%	62.3	0.458	3506	23.21	962
CJS-2056-4T	C	S	NO	1.01	57.3%	64.0	2.310	10049	48.37	1447
CJS-2056-4/8T	C	S	NO	1.01	61.2%	67.8	2.165	10049	48.37	1439
CJS-2056-6T	C	S	NO	1.00	54.7%	66.5	0.642	7300	17.65	966
CJS-2263-4T	C	S	NO	1.01	60.7%	64.1	4.407	10554	93.08	1437
CJS-2263-4/8T	C	S	NO	1.01	60.7%	63.6	4.407	10554	93.08	1464
CJS-2263-6T	C	S	NO	1.00	56.9%	65.1	1.510	7467	42.27	947
CJS-2071-4T	C	S	NO	1.01	63.9%	64.4	7.869	17360	106.36	1473
CJS-2071-4/8T	C	S	NO	1.01	63.9%	64.4	7.869	17360	106.36	1482
CJS-2071-6T-3	C	S	NO	1.01	57.3%	63.1	2.637	11095	49.97	954
CJS-2071-6T-5.5	C	S	NO	1.01	60.1%	64.9	3.150	13428	51.77	982
CJS-2880-6T	C	S	NO	1.01	53.7%	57.5	4.079	15923	50.52	976

* Data plug internal fan

Acoustic features

The specified values are determined according to free field measurements of pressure and sound levels in dB(A) at an equivalent distance of twice the fan's span plus the turbine's diameter, with a minimum of 1.5 m.

Sound power Lw(A) spectrum in dB(A) via frequency band in Hz.

Model	63	125	250	500	1000	2000	4000	8000	Model	63	125	250	500	1000	2000	4000	8000
1240	44	58	64	67	67	68	58	47	2263-6	61	67	72	73	77	76	69	62
1850-4	66	72	77	78	81	80	73	68	2263-8	59	64	70	72	70	67	60	52
1850-6	56	62	67	68	71	70	63	58	2271-4	80	81	89	92	95	96	92	78
1850-8	51	57	62	63	66	65	58	53	2271-6-3	65	71	76	77	81	80	73	66
2056-4	67	73	79	79	83	83	75	68	2271-6-5,5	66	65	80	79	83	83	72	61
2056-6	57	63	69	69	73	73	65	58	2271-8	65	66	74	77	80	81	77	63
2056-8	52	58	64	64	68	68	60	53	2880	68	74	79	80	84	83	76	69
2263-4	74	79	85	87	85	82	75	67									

Dimensions in mm

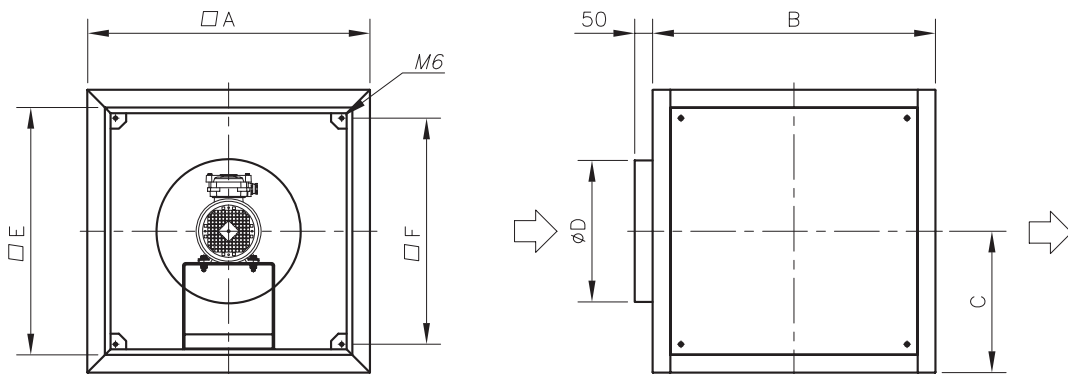

Model	A	B	C	D	E	F
CJS-1240-6T	800	800	400	400	700	640
CJS-1850-4T	800	800	400	400	700	640
CJS-1850-6T	800	800	400	400	700	640
CJS-2056-4T	925	925	462.5	450	825	765
CJS-2056-6T	925	925	462.5	450	825	765
CJS-2263-4T	1000	1000	500	630	900	840
CJS-2263-6T	925	925	462.5	560	825	765
CJS-2071-4T	1060	1060	530	710	960	900
CJS-2071-6T-3	1000	1000	500	630	900	840
CJS-2071-6T-5.5	1060	1060	530	710	960	900
CJS-2880-6T	1060	1060	530	710	960	900

Characteristic curves

Q = Airflow in m³/h, m³/s and cfm.

Pe= Static pressure in mm.w.c., Pa and inwg.

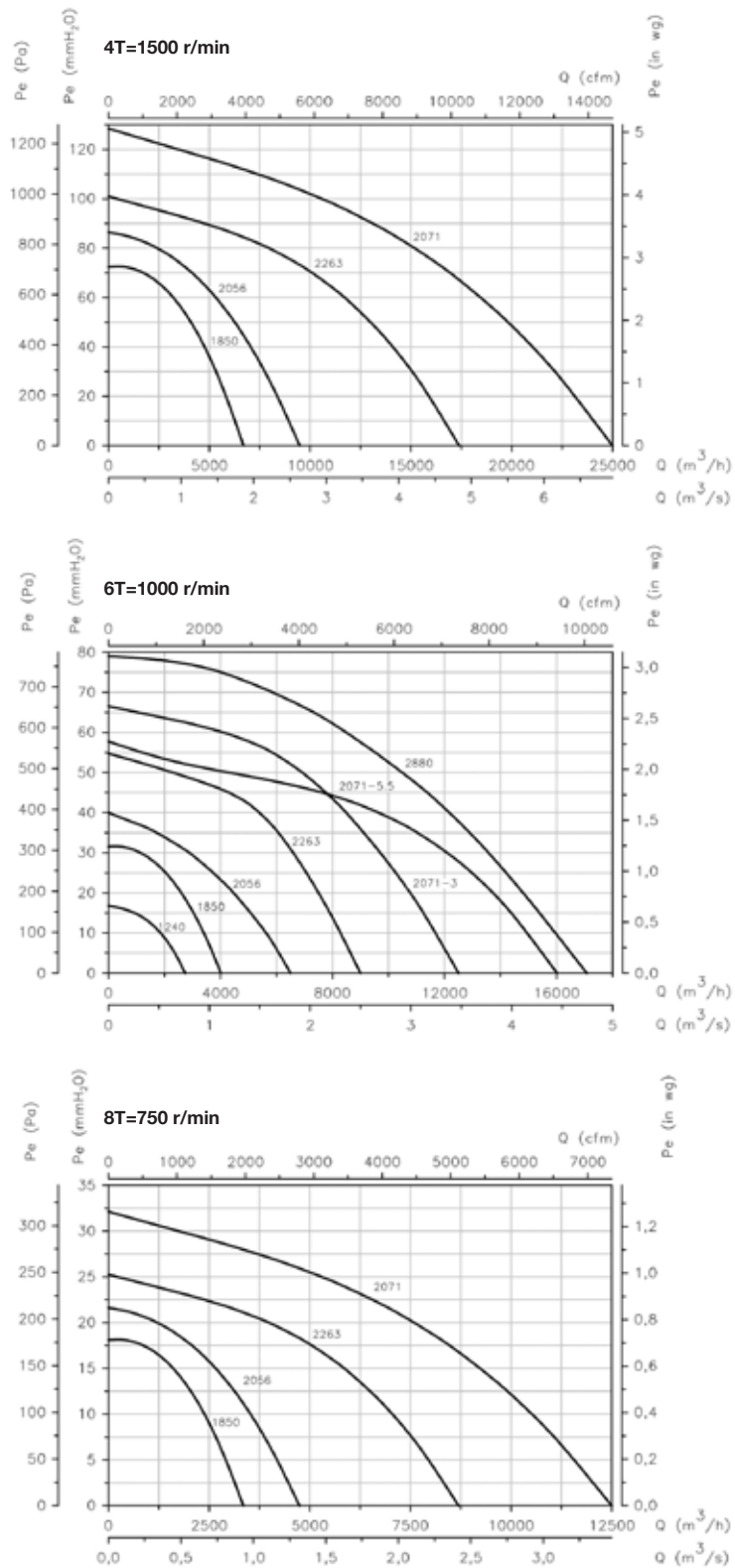

Accessories

See accessories section

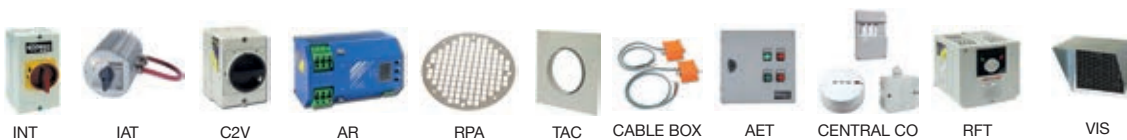

CJMD

400°C/2h and 300°C/2h extraction units with linear inlet and outlet



Extraction units to work inside fire danger zones at 400°C/2h, with soundproofed box.

Fan:

- Galvanised sheet steel structure with thermal insulation and soundproofing.
- Impeller with backward-curved blades and multi-blade impeller made from sheet steel
- Approval according to Standard EN-12101-3-2002, certificate no.: 0370-CPD-0399
- Linear air circulation

Motor:

- Class H motors, ongoing use S1 and emergency use S2, with ball bearings and IP55 protection
- Three-phase 230/400V.-50Hz. (up to 4CV) and 400/690V.-50Hz. (power over 4CV.)
- Max. temperature of air for transport: S1 Service -20°C+ 40°C for ongoing use, S2 Service 300°C/2h and 400°C/2h

Finish:

- Anticorrosive galvanized sheet steel.

On request:

- Fans with two-speed motor.



The sides on large models are built with pleats to ensure robustness

Order code

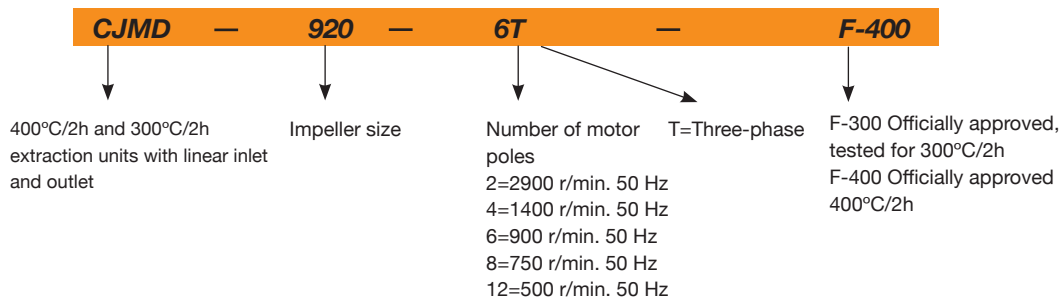

Technical characteristics

Model	Speed (r/min)	Maximum admissible current (A)			Power installed (kW)	Airflow maximum (m³/h)	Sound pressure level dB(A)	Approx. weight (Kg)
		230V	400V	690V				
CJMD-600-4T	1430	3.80	2.20		0.75	2445	58	68
CJMD-665-4T	1420	4.70	2.70		1.10	3385	62	80
CJMD-730-4T	1435	9.20	5.30		2.20	5005	66	100
CJMD-730-6T	940	4.40	2.60		0.75	3300	52	95
CJMD-800-4T	1440		8.40	4.85	4.00	6850	69	132
CJMD-800-6T	945	7.40	4.30		1.50	5115	56	116
CJMD-825-6T	950	10.30	5.90		2.20	6400	60	146
CJMD-885-6T	950	10.30	5.90		2.20	8105	63	164
CJMD-905-4T	1430	3.80	2.20		0.75	5800	63	133
CJMD-920-6T	950	10.30	5.90		2.20	7500	69	184
CJMD-960-4T	1420	4.70	2.70		1.10	8030	64	185
CJMD-1020-4T	1425	6.60	3.80		1.50	10500	66	198
CJMD-1020-6T	940	4.40	2.60		0.75	7410	56	197
CJMD-1160-6T	970		11.00	6.35	4.00	11000	71	263
CJMD-1225-4T	1430	11.40	6.60		3.00	15150	71	279
CJMD-1225-6T	945	6.40	3.70		1.10	10050	62	274
CJMD-1330-4T	1430		11.50	6.64	5.50	24450	72	409
CJMD-1330-6T	945	7.40	4.30		1.50	16100	63	370
CJMD-1550-4T	1455		23.00	13.28	11.00	34610	77	553
CJMD-1550-6T	945	15.00	8.70		3.00	22750	68	501



Erp. BEP (best efficiency point) characteristics

<(°)	Angle of inclination of the blades, in degrees	SR	Specific ratio
PN	Motor's nominal power in kW	ηe[%]	Efficiency
MC	Measurement category	N	Efficiency grade
EC	Efficiency category	[kW]	Input power
S	Static	[m³/h]	Airflow
T	Total	[mmH²O]	Static or total pressure (According to EC)
VSD	Variable-speed drive	[RPM]	Speed

Modelo	MC	EC	VSD	SR	ηe[%]	N	(kW)	(m³/h)	(mmH₂O)	(RPM)
CJMD-600-4T	A	S	NO	1.00	34.3%	43.7	0.326	1187	34.59	1479
CJMD-665-4T	A	S	NO	1.01	35.5%	43.5	0.553	1501	48.06	1470
CJMD-730-4T	A	S	NO	1.01	37.4%	43.5	1.086	2303	64.68	1475
CJMD-730-6T	A	S	NO	1.00	33.1%	42.1	0.386	1622	28.94	980
CJMD-800-4T	A	S	NO	1.01	39.0%	43.8	1.750	3120	80.29	1479
CJMD-800-6T	A	S	NO	1.00	35.5%	43.1	0.624	2332	34.85	983
CJMD-825-6T	A	S	NO	1.01	37.2%	43.6	0.964	3441	38.22	983
CJMD-885-6T	A	S	NO	1.01	41.1%	46.5	1.388	3946	53.00	976
CJMD-905-4T	A	S	NO	1.00	45.7%	58.5	0.608	2924	34.89	1461
CJMD-920-6T	A	S	NO	1.01	44.2%	48.3	2.202	5546	64.33	962
CJMD-960-4T	A	S	NO	1.01	50.2%	60.4	1.065	3883	50.49	1442
CJMD-1020-4T	A	S	NO	1.01	50.7%	58.7	1.759	5378	60.90	1437
CJMD-1020-6T	A	S	NO	1.00	45.5%	58.3	0.592	4109	24.02	969
CJMD-1160-6T	A	S	NO	1.01	33.3%	35.6	4.370	6929	77.00	975
CJMD-1225-4T	A	S	NO	1.01	54.3%	59.4	3.277	8342	78.29	1440
CJMD-1225-6T	A	S	NO	1.00	48.4%	58.7	1.054	5632	33.24	963
CJMD-1330-4T	B	T	NO	1.01	70.5%	72.4	6.537	13932	121.38	1432
CJMD-1330-6T	A	S	NO	1.00	56.7%	64.2	1.930	9620	41.77	948
CJMD-1550-4T	B	T	NO	1.01	69.9%	69.6	13.078	22380	149.81	1455
CJMD-1550-6T	B	T	NO	1.01	57.4%	61.5	4.069	15016	57.11	945

Acoustic features

The specified values are determined according to free field measurements of pressure and sound levels in dB(A) at an equivalent distance of twice the fan's span plus the turbine's diameter, with a minimum of 1.5 m.

Sound power Lw(A) spectrum in dB(A) via frequency band in Hz.

	63	125	250	500	1000	2000	4000	8000		63	125	250	500	1000	2000	4000	8000
600-4	33	43	54	61	65	62	60	53	960-4	51	64	70	75	72	75	70	56
665-4	37	47	58	65	69	66	64	57	1020-4	56	66	74	76	75	77	68	58
730-4	41	51	62	69	73	70	68	61	1020-6	45	57	64	69	65	61	54	46
730-6	27	37	48	55	59	56	54	47	1160-6	50	60	71	78	82	80	78	70
800-4	47	56	67	74	78	76	74	67	1225-4	61	70	83	79	82	83	77	63
800-6	34	43	54	61	65	63	61	54	1225-6	53	61	73	75	72	73	63	52
825-6	38	47	58	65	69	67	65	58	1330-4	72	77	83	85	83	80	73	65
885-6	41	50	61	68	72	70	68	61	1330-6	61	62	74	74	73	75	65	55
905-4	48	62	68	71	71	72	62	51	1550-4	75	76	85	88	90	91	87	74
920-6	48	58	69	76	80	78	76	68	1550-6	65	65	79	78	82	82	71	60

Dimensions in mm

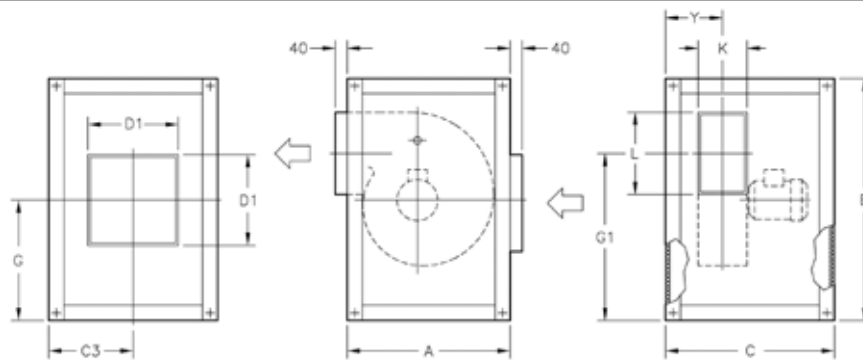

	A	B	C	C3	D1	G	G1	K	L	Y		A	B	C	C3	D1	G	G1	K	L	Y
CJMD-600-4T	735	755	604	302	400	378	500	140	215	190	CJMD-960-4T	1060	1080	966	483	60	540	694	355	450	443
CJMD-665-4T	790	810	678	339	400	405	540	165	250	215	CJMD-1020-4T	1150	1170	1038	519	800	585	756	400	500	490
CJMD-730-4T	855	874	748	374	400	437	577	180	295	237	CJMD-1020-6T	1150	1170	1038	519	800	585	756	400	500	490
CJMD-730-6T	855	874	748	374	400	437	577	180	295	237	CJMD-1160-6T	1375	1395	1098	549	800	698	999	315	450	414
CJMD-800-4T	941	961	798	399	500	481	653	200	320	264	CJMD-1225-4T	1204	1284	1258	629	800	642	836	450	560	545
CJMD-800-6T	941	961	798	399	500	481	653	200	320	264	CJMD-1225-6T	1204	1284	1258	629	800	642	836	450	560	545
CJMD-825-6T	1039	1059	892	446	500	530	770	230	280	296	CJMD-1330-4T	1338	1418	1474	737	800	709	921	500	630	620
CJMD-885-6T	1148	1168	938	469	500	585	849	250	320	330	CJMD-1330-6T	1338	1418	1474	737	800	709	921	500	630	620
CJMD-905-4T	970	990	896	448	500	495	636	315	400	398	CJMD-1550-4T	1495	1575	1648	824	1000	788	1032	560	710	675
CJMD-920-6T	1268	1287	954	477	600	644	945	284	360	372	CJMD-1550-6T	1495	1575	1648	824	1000	788	1032	560	710	675

Characteristic curves

Q = Airflow in m³/h, m³/s and cfm.

Pe= Static pressure in mm.w.c., Pa and inwg.

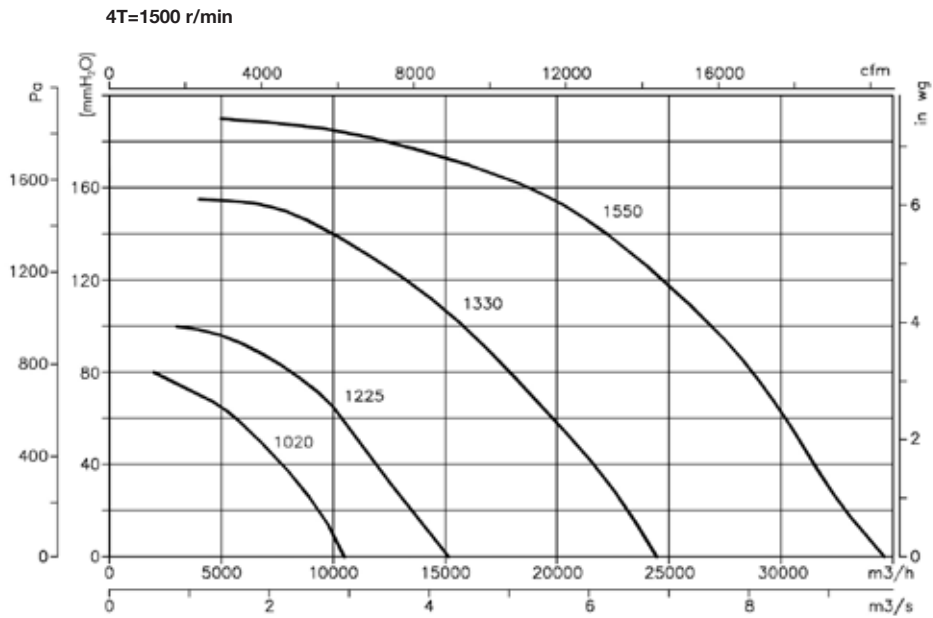
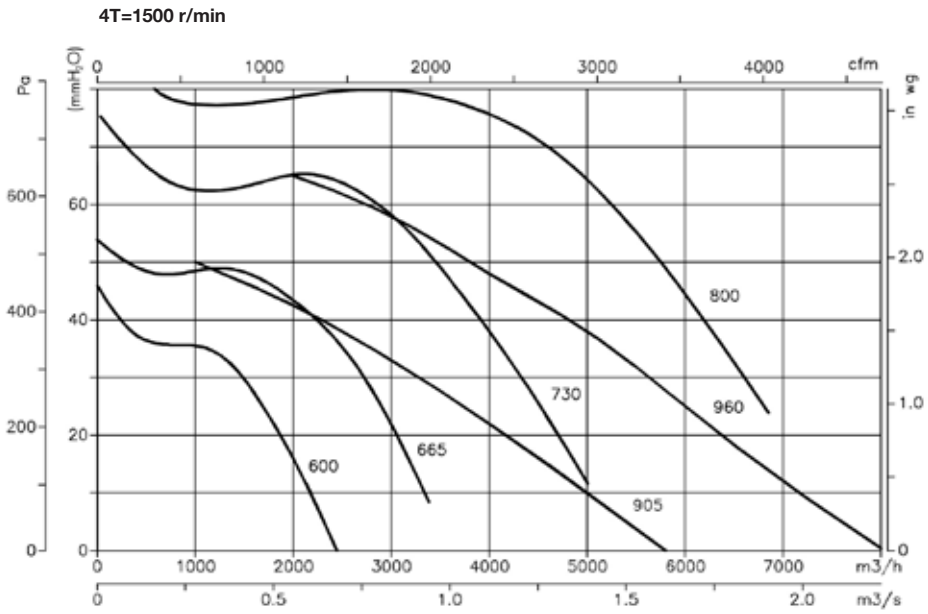

Characteristic curves

Q = Airflow in m³/h, m³/s and cfm.

Pe= Static pressure in mm.w.c., Pa and inwg.

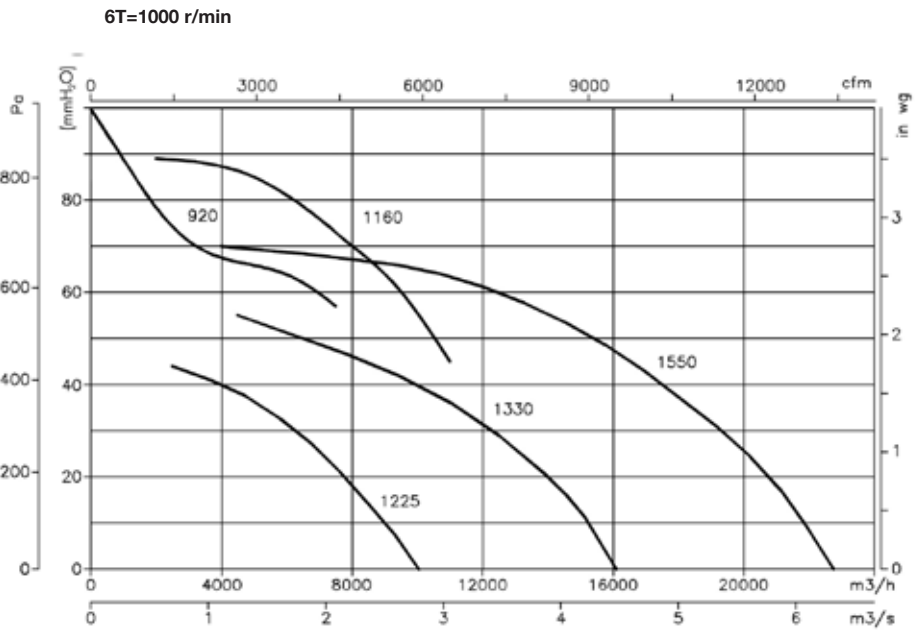
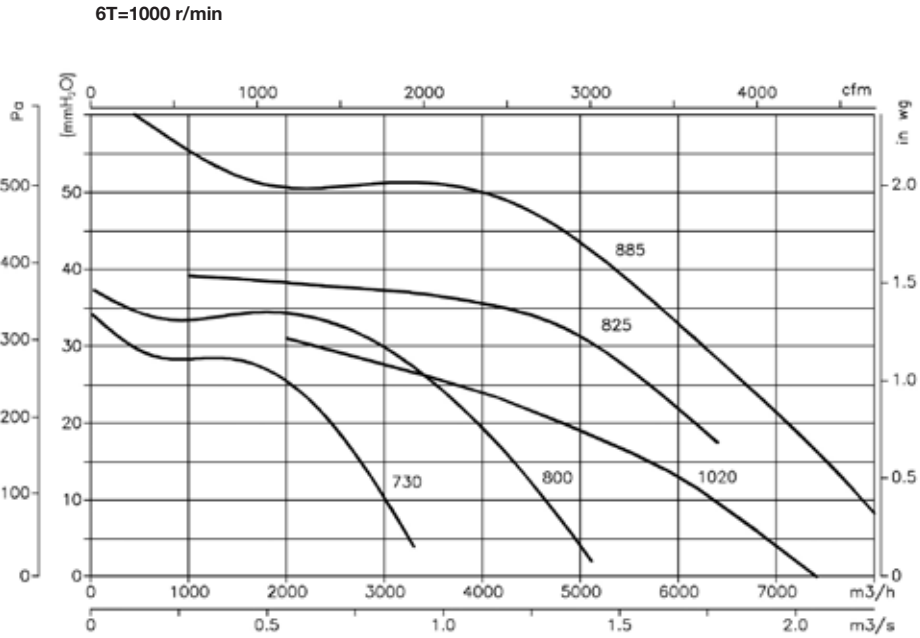

Accessories

See accessories section



TCR/R CJTCR/R



400°C/2h centrifugal fans and extraction units with backward-curved impeller

TCR/R: Robust centrifugal single-inlet fans to work outside fire danger zones at 400°C/2h, fitted with impeller with backward-curved blades.

CJTCR/R: Robust single-inlet fans with soundproofed plate to work outside fire danger zones at 400°C/2h.



TCR/R



CJTCR/R

Fan:

- Steel sheet casing
- Impeller with backward-curved blades made from robust sheet steel and heat-resistant paint
- Approval according to Standard EN-12101-3-2002, certificate no.: 0370-CPD-0400 (TCR/R), and No.: 0370-CPD-0401 (CJTCR/R)

Motor:

- Class F motors with ball bearings, IP55 protection
- Three-phase 230/400V.-50Hz. (up to 5.5CV.) and 400/690V.-50Hz. (power over 5.5CV.)
- Max. temperature of air for transport: S1 Service -20°C+ 250°C for ongoing use, S2 Service 200°C/2h, 300°C/2h and 400°C/2h

Finish:

- Anticorrosive finish in polyester resin, polymerised at 190°C, after alkaline degreasing and phosphate-free pre-treatment.
- CJTCR/R: Anticorrosive galvanized sheet steel.

On request:

- Fans with two-speed motor.
- Belt-driven fans



High-performance and robust backward-curved impeller.

Order code

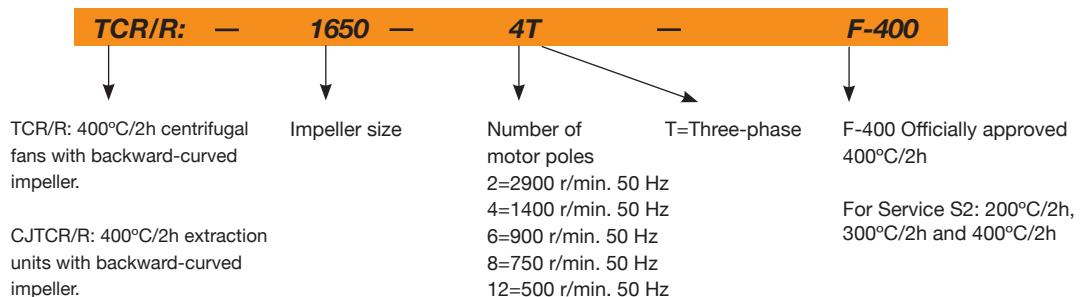

Technical characteristics

Model	Speed (r/min)	Maximum admissible current (A)			Power installed (kW)	Airflow maximum (m³/h)	Sound pressure level dB(A)		Approx. weight (Kg)	
		230V	400V	690V			TCR/R	CJCR/R	TCR/R	CJTCR/R
TCR/R CJTCR/R 1240-2T	2870	13.60	7.82		4.00	11100	86	81	93	147
TCR/R CJTCR/R 1240-4T	1410	3.10	1.79		0.75	5800	71	66	71	125
TCR/R CJTCR/R 1445-2T	2870		14.50	8.37	7.50	16500	87	82	126	210
TCR/R CJTCR/R 1445-4T	1400	4.03	2.32		1.10	8030	72	67	93	177
TCR/R CJTCR/R 1650-4T	1430	5.96	3.44		1.50	10500	74	68	114	189
TCR/R CJTCR/R 1650-6T	945	3.90	2.20		0.75	7410	64	59	111	186
TCR/R CJTCR/R 1856-4T	1445	10.96	6.33		3.00	15150	79	74	152	273
TCR/R CJTCR/R 1856-6T	945	4.88	2.82		1.10	10050	70	65	145	266
TCR/R CJTCR/R 2063-4T	1440		11.60	6.70	5.50	24450	80	75	225	380
TCR/R CJTCR/R 2063-6T	955	6.42	3.71		1.50	16100	71	66	209	364
TCR/R CJTCR/R 2271-4T	1460		20.20	11.66	11.00	34610	85	79	315	508
TCR/R CJTCR/R 2271-6T	960	12.70	7.30		3.00	22750	76	71	280	473



Erp. BEP (best efficiency point) characteristics

<(°)	Angle of inclination of the blades, in degrees	SR	Specific ratio
PN	Motor's nominal power in kW	ηe[%]	Efficiency
MC	Measurement category	N	Efficiency grade
EC	Efficiency category	[kW]	Input power
S	Static	[m³/h]	Airflow
T	Total	[mmH²O]	Static or total pressure (According to EC)
VSD	Variable-speed drive	[RPM]	Speed

	MC	EC	VSD	SR	ηe[%]	N	(kW)	(m³/h)	(mmH₂O)	(RPM)
1240-2T	A	S	NO	1.02	67.6%	71.1	4.622	6744	169.95	2871
1240-4T	A	S	NO	1.00	50.6%	63.8	0.550	2924	34.89	1448
1445-2T	A	S	NO	1.02	63.4%	64.5	7.943	8951	206.50	2879
1445-4T	A	S	NO	1.01	55.3%	66.0	0.966	3883	50.49	1428
1650-4T	A	S	NO	1.01	58.3%	66.8	1.532	5378	60.90	1441
1650-6T	A	S	NO	1.00	47.6%	60.7	0.566	4109	24.02	969
1856-4T	A	S	NO	1.01	58.8%	64.2	3.028	8342	78.29	1453
1856-6T	A	S	NO	1.00	50.4%	60.8	1.013	5632	33.24	960
2063-4T	B	T	NO	1.01	76.4%	78.7	6.032	13932	121.38	1442
2063-6T	A	S	NO	1.00	61.2%	69.0	1.790	9620	41.77	957
2271-4T	B	T	NO	1.01	75.4%	75.3	12.117	22380	149.81	1460
2271-6T	B	T	NO	1.01	65.9%	70.6	3.546	15016	57.11	960

Acoustic features

The specified values are determined according to free field measurements of pressure and sound levels in dB(A) at an equivalent distance of twice the fan's span plus the iturbine's diameter, with a minimum of 1.5 m.

Sound power Lw(A) spectrum in dB(A) via frequency band in Hz.

TCR/R Model	63	125	250	500	1000	2000	4000	8000	CJTCR/R Model	63	125	250	500	1000	2000	4000	8000
1240-2	68	83	81	93	90	94	96	83	1240-2	63	78	76	88	85	89	91	78
1240-4	56	40	76	79	79	80	70	59	1240-4	51	65	71	74	74	75	65	54
1445-2	73	85	83	95	93	97	99	89	1445-2	68	80	78	90	88	92	94	84
1445-4	59	72	78	83	80	83	78	64	1445-4	54	67	73	78	75	78	73	59
1650-4	64	74	82	84	83	85	76	66	1650-4	58	68	76	78	77	79	70	60
1650-6	53	65	72	77	73	69	62	54	1650-6	48	60	67	72	68	64	57	49
1856-4	69	78	91	87	90	91	85	71	1856-4	64	73	86	82	85	86	80	66
1856-6	61	69	81	83	80	81	71	60	1856-6	56	64	76	78	75	76	66	55
2063-4	80	85	91	93	91	88	81	73	2063-4	75	80	86	88	86	83	76	68
2063-6	69	70	82	82	81	83	73	63	2063-6	64	65	77	77	76	78	68	58
2271-4	83	84	93	96	98	99	95	82	2271-4	77	78	87	90	92	93	89	76
2271-6	73	73	87	86	90	90	79	68	2271-6	68	68	82	81	85	85	74	63

Positions

LG 270 standard supply



Dimensions in mm

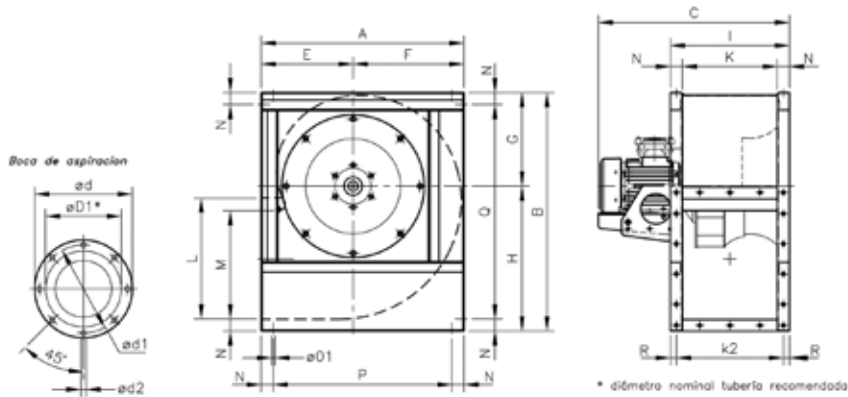

Model	A	B	C	ØD1*	Ød	Ød1	Ød2	E	F	G	H	I	M	N	Ø01	P	Q	R
TCR/R 1240-2T	673	790	734	400	472	444	M.8	305	368	310	480	395	358.5	40	11	593	710	20
TCR/R 1240-4T	673	790	634	400	472	444	M.8	305	368	310	480	395	358.5	40	11	593	710	20
TCR/R 1445-2T	765	880	815	450	522	494	M.8	350	415	339	541	445	407	45	11	675	790	20
TCR/R 1445-4T	765	880	727	450	522	494	M.8	350	415	339	541	445	407	45	11	675	790	20
TCR/R 1650-4T	832	970	770.5	500	582	555	M.10	375	457	378	592	490	445	45	13	742	880	20
TCR/R 1650-6T	832	970	770.5	500	582	555	M.10	375	457	378	592	490	445	45	13	742	880	20
TCR/R 1856-4T	925	1084	857.5	560	645	615	M.10	415	510	424	660	550	493	50	13	825	984	25
TCR/R 1856-6T	925	1084	828	560	645	615	M.10	415	510	424	660	550	493	50	13	825	984	25
TCR/R 2063-4T	1037	1218	955	630	720	688	M.10	465	572	477	741	620	530	60	13	917	1098	30
TCR/R 2063-6T	1037	1218	932	630	720	688	M.10	465	572	477	741	620	530	60	13	917	1098	30
TCR/R 2271-4T	1173	1375	1149	710	800	768	M.12	525	648	538	837	690	603.5	65	13	1043	1245	32.5
TCR/R 2271-6T	1173	1375	1112	710	800	768	M.12	525	648	538	837	690	603.5	65	13	1043	1245	32.5

Outlet

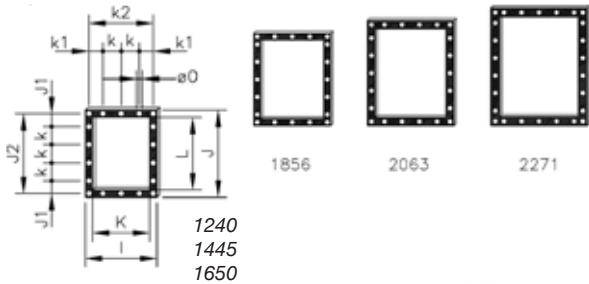

Model	I	J	J1	J2	K	k	k1	k2	L	Ø0
TCR/R-1240	395	480	70	440	315	100	77.5	355	400	11
TCR/R-1445	445	540	99	498	355	100	102.5	405	450	11
TCR/R-1650	490	590	87.5	550	400	125	100	450	500	13
TCR/R-1856	550	660	55	610	450	125	125	500	560	13
TCR/R-2063	620	750	95	690	500	125	92.5	560	630	13
TCR/R-2271	690	840	75	775	560	125	62.5	625	710	13

Standard supply: LG-270

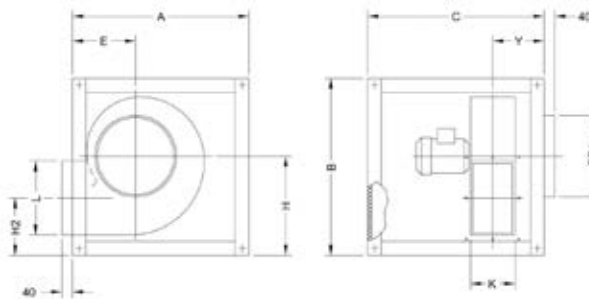

Model	A	B	C	ØD1	E	H	H2	K	L	Y
CJTCR/R-1240	970	970	970	400	312	549	308	315	400	307.5
CJTCR/R-1445	1070	1070	1070	450	357	610	339	355	450	333.5
CJTCR/R-1650	1160	1160	1160	500	382	660	365	400	500	355
CJTCR/R-1856	1260	1260	1050	560	422	727	399	450	560	360
CJTCR/R-2063	1400	1400	1200	630	472	810	444	500	630	395
CJTCR/R-2271	1555	1555	1355	710	532	906	560	560	715	430

Dimensions in mm

Supplied on request: LG-0

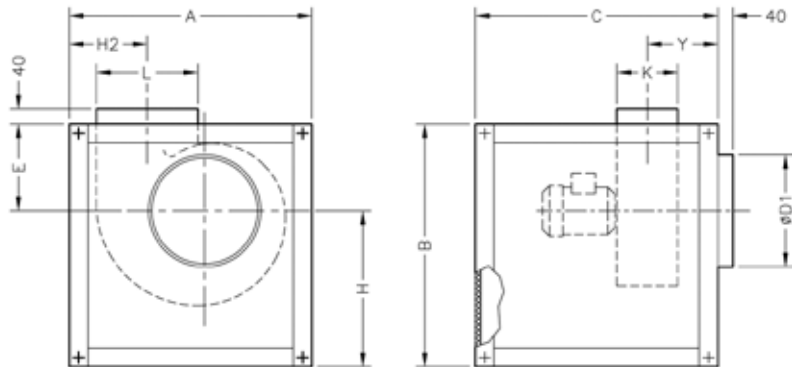

Model	A	B	C	ØD1	E	H	H2	K	L	Y
CJTCR/R-1240	970	970	970	400	533	437	322	315	400	307.5
CJTCR/R-1445	1070	1070	1070	450	586	484	367	355	450	333.5
CJTCR/R-1650	1160	1160	1160	500	634.5	525.5	391.5	400	500	355
CJTCR/R-1856	1260	1260	1050	560	681.5	578.5	442.5	450	560	360
CJTCR/R-2063	1400	1400	1200	630	759	641	482	500	630	395
CJTCR/R-2271	1555	1555	1355	710	838	717	518.5	560	715	430

Supplied on request: LG-90

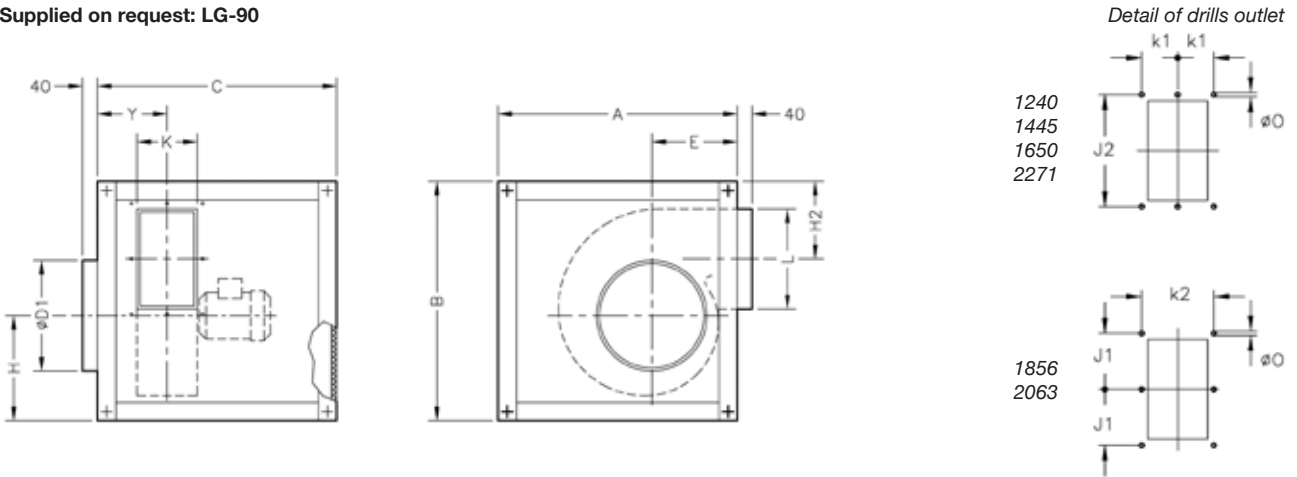

Model	A	B	C	ØD1	E	H	H2	K	L	Y
CJTCR/R-1240	970	970	970	400	312	379	350	315	400	307.5
CJTCR/R-1445	1070	1070	1070	450	357	408	391	355	450	333.5
CJTCR/R-1650	1160	1160	1160	500	382	447	419	400	500	355
CJTCR/R-1856	1260	1260	1050	560	422	495	438	450	560	360
CJTCR/R-2063	1400	1400	1200	630	472	546	488	500	630	395
CJTCR/R-2271	1555	1555	1355	710	532	607	532	560	715	430

Model	k1	k2	J1	J2	Ø0
CJTCR/R-1240	177.5	-	-	440	11
CJTCR/R-1445	202.5	-	-	498	11
CJTCR/R-1650	225	-	-	550	13
CJTCR/R-1856	-	500	305	-	13
CJTCR/R-2063	-	560	345	-	13
CJTCR/R-2271	312.5	-	-	775	13

Characteristic curves

Q = Airflow in m³/h, m³/s and cfm.

Pe= Static pressure in mm.w.c., Pa and inwg.

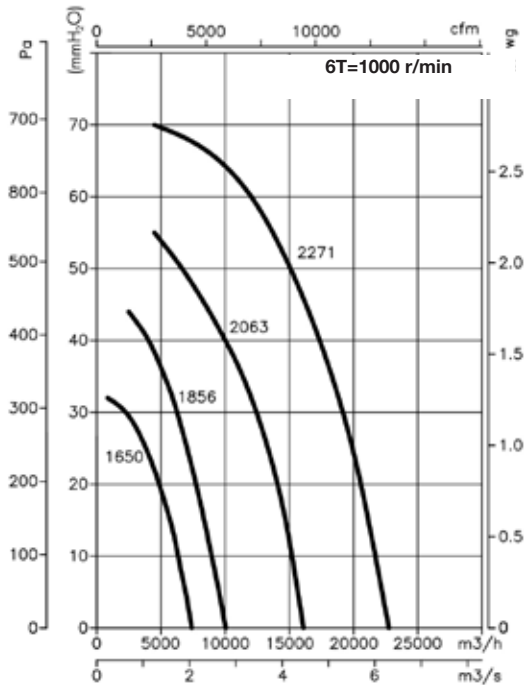
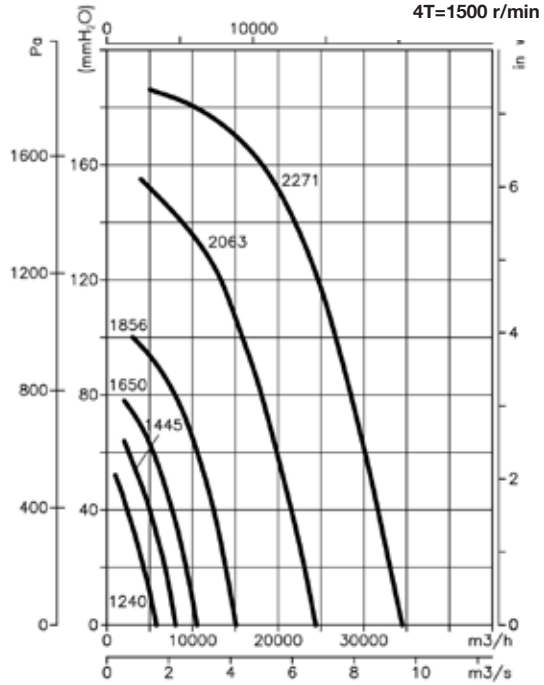
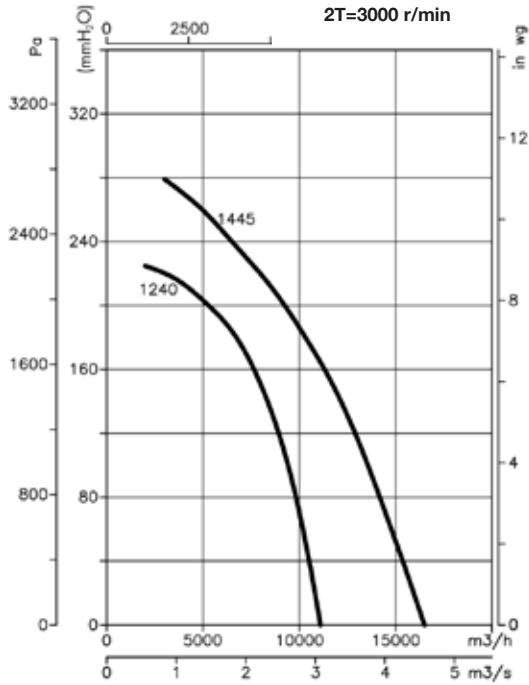

Accessories

See accessories section



TCMP CJMP



TCMP



CJMP

400°C/2h centrifugal fans and extraction units with multi-blade impeller

TCMP: 400°C/2h centrifugal single-inlet fans to work outside fire danger zones.

CJMP: Extraction single-inlet units with soundproofed plate to work outside fire danger zones at 400°C/2h.

Fan:

- Steel sheet casing
- Impeller with forward-facing blades made from galvanised sheet steel
- Approval according to Standard EN-12101-3-2002, certificate no.: 0370-CPD-0313 (TCMP), No.: 0370-CPD-0402 (CJMP)

Motor:

- Class F motors with ball bearings, IP55 protection
- Three-phase 230/400V.-50Hz. (up to 5.5CV.) and 400/690V.-50Hz. (power over 5.5CV.)
- Max. temperature of air for transport: S1 Service -20°C+ 300°C for ongoing use, S2 Service 200°C/2h, 300°C/2h and 400°C/2h

Finish:

- Anticorrosive finish in polyester resin, polymerised at 190°C, after alkaline degreasing and phosphate-free pre-treatment.
- CJMP: Anticorrosive galvanized sheet steel.

On request:

- Fans with two-speed motor.
- Belt-driven fans



Order code

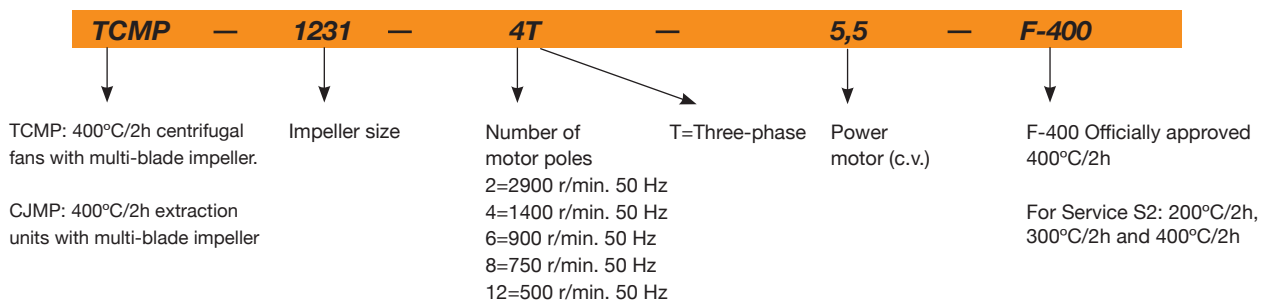

Technical characteristics

Model	Speed (r/min)	Maximum admissible current (A)			Power installed (kW)	Airflow maximum (m³/h)	Sound pressure level dB(A)		Approx. weight (Kg)	
		230V	400V	690V			TCMP	CJMP	TCMP	CJMP
TCMP CJMP 820-4T	1350	1.66	0.96		0.25	1665	65	59	11	25
TCMP CJMP 922-4T	1380	2.92	1.69		0.55	2450	66	60	20	55
TCMP CJMP 1025-4T-1.5	1400	4.03	2.32		1.10	3385	70	64	28	69
TCMP CJMP 1025-4T-2	1430	5.96	3.44		1.50	3650	72	66	31	72
TCMP CJMP 1128-4T-3	1445	8.36	4.83		2.20	5005	74	68	38	87
TCMP CJMP 1128-4T-4	1445	10.96	6.33		3.00	5450	75	69	41	90
TCMP CJMP 1128-6T	945	3.90	2.20		0.75	3300	60	55	30	79
TCMP CJMP 1231-4T-3	1445	8.36	4.83		2.20	4740	73	67	45	103
TCMP CJMP 1231-4T-4	1445	10.96	6.33		3.00	5910	75	69	48	106
TCMP CJMP 1231-4T-5.5	1440	14.10	8.12		4.00	6850	77	71	55	113
TCMP CJMP 1231-6T	955	6.42	3.71		1.50	5115	64	59	45	103
TCMP CJMP 1435-4T-4	1445	10.96	6.33		3.00	5395	76	70	55	126
TCMP CJMP 1435-4T-5.5	1440	14.10	8.12		4.00	6575	78	72	62	133
TCMP CJMP 1435-4T-7.5	1440		11.60	6.70	5.50	7940	80	74	72	143
TCMP CJMP 1435-4T-10	1455		14.20	8.20	7.50	9370	82	76	80	151
TCMP CJMP 1435-6T	955	9.30	5.30		2.20	6400	68	63	57	128
TCMP CJMP 1640-4T-5.5	1440	14.10	8.12		4.00	7000	77	71	81	151
TCMP CJMP 1640-4T-7.5	1440		11.60	6.70	5.50	8035	80	74	91	161
TCMP CJMP 1640-4T-10	1455		14.20	8.20	7.50	9710	82	76	99	169

Technical characteristics

Model	Speed (r/min)	Maximum admissible current (A)			Power installed (kW)	Airflow maximum (m³/h)	Sound pressure level dB(A)		Approx. weight (Kg)	
		230V	400V	690V			TCMP	CJMP	TCMP	CJMP
TCMP CJMP 1640-6T	955	9.30	5.30		2.20	8105	71	66	76	146
TCMP CJMP 1845-4T-7.5	1440		11.60	6.70	5.50	8000	82	76	100	181
TCMP CJMP 1845-4T-10	1455		14.20	8.20	7.50	10000	85	79	108	189
TCMP CJMP 1845-6T	955	9.30	5.30		2.20	7500	77	72	85	166
TCMP CJMP 2050-4T-10	1455		14.20	8.20	7.50	8975	83	77	130	233
TCMP CJMP 2050-4T-15	1460		20.20	11.66	11.00	12525	87	81	154	257
TCMP CJMP 2050-4T-20	1460		27.50	15.88	15.00	16500	89	83	166	269
TCMP CJMP 2050-6T	960	16.50	9.46		4.00	11000	79	74	125	228



Erp. BEP (best efficiency point) characteristics

	MC	EC	VSD	SR	ηe[%]	N	(kW)	(m³/h)	(mmH ₂ O)	(RPM)
820-4T	A	S	NO	1.00	35.2%	46.5	0.165	721	29.53	1441
922-4T	A	S	NO	1.00	36.4%	46.0	0.307	1187	34.59	1437
1025-4T-1.5	A	S	NO	1.01	38.9%	47.1	0.506	1501	48.06	1462
1025-4T-2	A	S	NO	1.01	35.3%	43.1	0.582	1541	48.88	1478
1128-4T-3	A	S	NO	1.01	40.5%	46.8	1.002	2303	64.68	1479
1128-4T-4	A	S	NO	1.01	40.2%	46.3	1.059	2370	65.85	1483
1128-6T	A	S	NO	1.00	36.8%	46.0	0.348	1622	28.94	981
1231-4T-3	A	S	NO	1.01	41.7%	46.9	1.482	2927	77.43	1469
1231-4T-4	A	S	NO	1.01	41.2%	46.2	1.613	3143	77.62	1475
1231-4T-5.5	A	S	NO	1.01	41.3%	46.2	1.653	3120	80.29	1478
1231-6T	A	S	NO	1.00	38.3%	46.1	0.579	2332	34.85	986
1435-4T-4	A	S	NO	1.01	42.4%	46.3	2.428	3916	96.46	1462
1435-4T-5.5	A	S	NO	1.01	42.4%	46.3	2.425	3865	97.59	1468
1435-4T-7.5	A	S	NO	1.01	42.5%	46.3	2.492	3904	99.52	1476
1435-4T-10	A	S	NO	1.01	42.5%	46.6	2.271	3629	97.61	1470
1435-6T	A	S	NO	1.01	39.6%	46.2	0.906	3441	38.22	985
1640-4T-5.5	A	S	NO	1.01	55.4%	58.7	3.000	4685	130.10	1461
1640-4T-7.5	A	S	NO	1.01	48.0%	50.6	3.899	5080	135.33	1463
1640-4T-10	A	S	NO	1.02	43.1%	45.2	4.596	5382	135.00	1476
1640-6T	A	S	NO	1.01	43.9%	49.5	1.300	3946	53.00	978
1845-4T-7.5	A	S	NO	1.02	57.0%	58.3	6.385	7900	169.13	1439
1845-4T-10	A	S	NO	1.02	56.7%	57.6	7.387	8599	178.87	1461
1845-6T	A	S	NO	1.01	47.0%	51.3	2.070	5546	64.33	965
2050-4T-10	A	S	NO	1.02	54.9%	55.4	8.393	8977	188.36	1455
2050-4T-15	A	S	NO	1.02	55.7%	56.0	9.285	9695	195.91	1470
2050-4T-20	B	T	NO	1.03	69.8%	69.5	16.819	16500	261.08	1459
2050-6T	A	S	NO	1.01	36.5%	39.0	3.988	6929	77.00	966

Acoustic features:

The specified values are determined according to free field measurements of pressure and sound levels in dB(A) at an equivalent distance of twice the fan's span plus the turbine's diameter, with a minimum of 1.5 m.

CJMP	Sound power Lw(A) spectrum in dB(A) via frequency band in Hz.																
	63	125	250	500	1000	2000	4000	8000	CJMP	63	125	250	500	1000	2000	4000	8000
820	40	50	61	68	72	69	67	60	1435-4-4	54	63	74	81	85	83	81	74
922	41	51	62	69	73	70	68	61	1435-4-5.5	56	65	76	83	87	85	83	76
1025-4-1.5	45	55	66	73	77	74	72	65	1435-4-7.5	58	67	78	85	89	87	85	78
1025-4-2	47	57	68	75	79	76	74	67	1435-4-10	60	69	80	87	91	89	87	80
1128-4-3	49	59	70	77	81	78	76	69	1435-6	46	55	66	73	77	75	73	66
1128-4-4	50	60	71	78	82	79	77	70	1640-4-5.5	55	64	75	82	86	84	82	75
1128-6	35	45	56	63	67	64	62	55	1640-4-7.5	58	67	78	85	89	87	85	78
1231-4-3	51	60	71	78	82	80	78	71	1640-4-10	60	69	80	87	91	89	87	80
1231-4-4	53	62	73	80	84	82	80	73	1640-6	49	58	69	76	80	78	76	69
1231-4-5.5	55	64	75	82	86	84	82	75	1845-4-7.5	61	71	82	89	93	91	89	81
1231-6	42	51	62	69	73	71	69	62	1845-4-10	64	74	85	92	96	94	92	84

Acoustic features

1845-6	56	66	77	84	88	86	84	76	1435-4-4	48	57	68	75	79	77	75	68
2050-4-10	62	72	83	90	94	92	90	82	1435-4-5,5	50	59	70	77	81	79	77	70
2050-4-15	66	76	87	94	98	96	94	86	1435-4-7,5	52	61	72	79	83	81	79	72
2050-4-20	68	78	89	96	100	98	96	88	1435-4-10	54	63	74	81	85	83	81	74
2050-6	58	68	79	86	90	88	86	78	1435-6	41	50	61	68	72	70	68	61
820	34	44	55	62	66	63	61	54	1640-4-5,5	49	58	69	76	80	78	76	69
922	35	45	56	63	67	64	62	55	1640-4-7,5	52	61	72	79	83	81	79	72
1025-4-1,5	39	49	60	67	71	68	66	59	1640-4-10	54	63	74	81	85	83	81	74
1025-4-2	41	51	62	69	73	70	68	61	1640-6	44	53	64	71	75	73	71	64
1128-4-3	43	53	64	71	75	72	70	63	1845-4-7,5	55	65	76	83	87	85	83	75
1128-4-4	44	54	65	72	76	73	71	64	1845-4-10	58	68	79	86	90	88	86	78
1128-6	30	40	51	58	62	59	57	50	1845-6	51	61	72	79	83	81	79	71
1231-4-3	45	54	65	72	76	74	72	65	2050-4-10	56	66	77	84	88	86	84	76
1231-4-4	47	56	67	74	78	76	74	67	2050-4-15	60	70	81	88	92	90	88	80
1231-4-5,5	49	58	69	76	80	78	76	69	2050-4-20	62	72	83	90	94	92	90	82
1231-6	37	46	57	64	68	66	64	57	2050-6	53	63	74	81	85	83	81	73

Dimensions in mm

Inlet

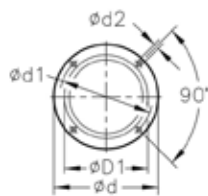

Outlet

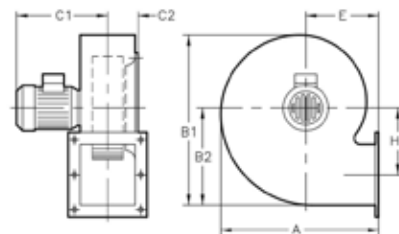
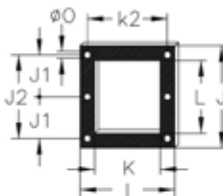

	A	B1	B2	C1	C2	ϕD_1^*	ϕd	ϕd_1	ϕd_2	E	H1	I	J	J1	J2	K	k2	L	ϕO
820-4T	322	377	223	272	68.5	200	247	230	M.6	137.5	137	184	213	94.5	189	130	160	156	9

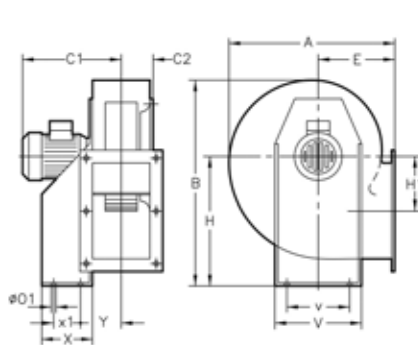

922/1025/1128/1231

Inlet

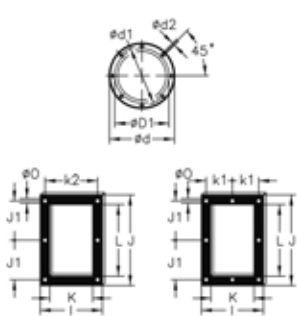

Outlet

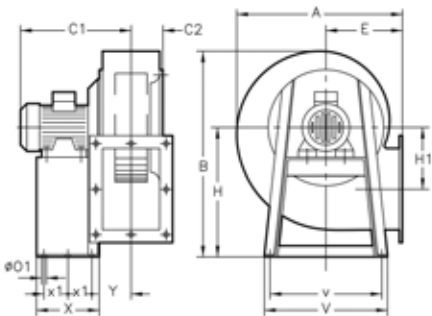

1435/1640/1845/2050

	A	B	C1	C2	ϕD_1^*	ϕd	ϕd_1	ϕd_2	E	H	H1	I	J	J1	K	k1	k2	L	ϕO	ϕO_1	V	v	X	x1	Y
922	388,5	455	332	73,5	224	278	256	M.8	180	280	134	204	282,5	128	140	-	180	215	9,5	10,5	290	220	114	50	105
1025	427	503	393	86	250	305	282	M.8	197	310	144	229	312,5	145	165	-	205	250	9,5	12,5	315	228	134	74	115,5
1128-4T	472	553	430	93,5	280	348	320	M.8	216	340	152	244	364	170	180	-	220	296,5	9,5	12,5	348	245	144	95	122,5
1128-6T	472	553	400	93,5	280	348	320	M.8	216	340	152	244	364	170	180	-	220	296,5	9,5	12,5	348	245	144	95	122,5
1231-3	526	630	440	103,5	315	382	354	M.8	238	390	179,5	264	382,5	180	200	-	240	320	11,5	13	382	322	183	140	126
1231-4	526	630	440	103,5	315	382	354	M.8	238	390	179,5	264	382,5	180	200	-	240	320	11,5	13	382	322	183	140	126
1231-5,5	526	630	463	103,5	315	382	354	M.8	238	390	179,5	264	382,5	180	200	-	240	320	11,5	13	382	322	183	140	126
1231-6T	526	630	440	103,5	315	382	354	M.8	238	390	179,5	264	382,5	180	200	-	240	320	11,5	13	382	322	183	140	126
1435-4	573,5	715	464	118	355	422	394	M.8	250	445	242,5	292	342,5	159	228	133	-	280	11,5	13	456	420	333	136,5	150
1435-5,5	573,5	715	477	118	355	422	394	M.8	250	445	242,5	292	342,5	159	228	133	-	280	11,5	13	456	420	333	136,5	150
1435-7,5	573,5	715	525	118	355	422	394	M.8	250	445	242,5	292	342,5	159	228	133	-	280	11,5	13	456	420	333	136,5	150
1435-10	573,5	715	525	118	355	422	394	M.8	250	445	242,5	292	342,5	159	228	133	-	280	11,5	13	456	420	333	136,5	150
1435-6T	573,5	715	487	118	355	422	394	M.8	250	445	242,5	292	342,5	159	228	133	-	280	11,5	13	456	420	333	136,5	150
1640-5,5	634	799	499	130	400	464	438	M.8	270	495	271	336	404	185	250	150	-	321	11,5	13	500	460	327	133,5	162,5
1640-7,5	634	799	537	130	400	464	438	M.8	270	495	271	336	404	185	250	150	-	321	11,5	13	500	460	327	133,5	162,5
1640-10	634	799	537	130	400	464	438	M.8	270	495	271	336	404	185	250	150	-	321	11,5	13	500	460	327	133,5	162,5
1640-6T	634	799	499	130	400	464	438	M.8	270	495	271	336	404	185	250	150	-	321	11,5	13	500	460	327	133,5	162,5
1845-4T	711	901	554	147	450	515	485	M.8	302	560	305	370	444	202	284	164	-	361	11,5	13	538	502	340	140	179,5
1845-6T	711	901	516	147	450	515	485	M.8	302	560	305	370	444	202	284	164	-	361	11,5	13	538	502	340	140	179,5
2050-10	797	987	572	162,5	500	565	535	M.10	345	610	313	411	544	250	315	182,5	-	451	11,5	13	635	615	435	188	196
2050-12,5	797	987	624	162,5	500	565	535	M.10	345	610	313	411	544	250	315	182,5	-	451	11,5	13	635	615	435	188	196
2050-15	797	987	677	162,5	500	565	535	M.10	345	610	313	411	544	250	315	182,5	-	451	11,5	13	635	615	435	188	196
2050-20	797	987	677	162,5	500	565	535	M.10	345	610	313	411	544	250	315	182,5	-	451	11,5	13	635	615	435	188	196
2050-6T	797	987	572	162,5	500	565	535	M.10	345	610	313	411	544	250	315	182,5	-	451	11,5	13	635	615	435	188	196

Dimensions in mm

Standard supply outlet: LG-270

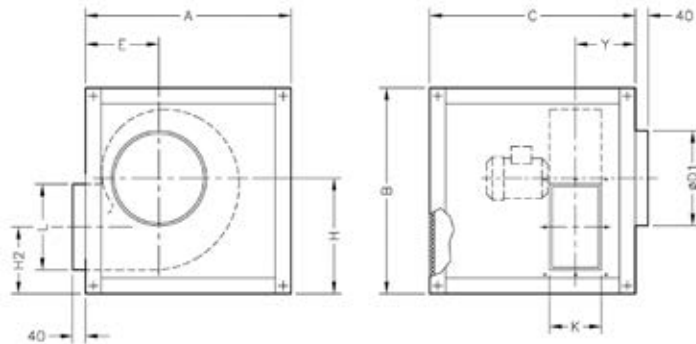

Detail of drills outlet

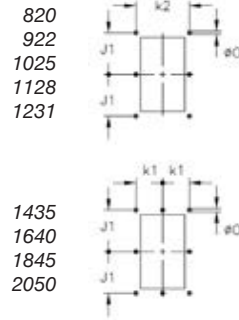

Model	A	B	C	ØD1	E	H	H2	K	L	Y
CJMP-820	400	450	450	200	142	263	126	130	156	112
CJMP-922	610	610	610	224	187	349	215	140	215	176
CJMP-1025	660	660	660	250	204	379	235	165	250	178.5
CJMP-1128	720	720	720	280	223	409	257	180	295	191
CJMP-1231	800	800	800	315	245	459	279.5	200	320	205
CJMP-1435	880	880	880	355	257	514	271.5	230	280	291
CJMP-1640	970	970	970	400	277	564	293	250	320	324
CJMP-1845	1070	1070	1070	450	309	629	324	284	360	357
CJMP-2050	1160	1160	1160	500	352	679	366	315	450	385.5

Model	k1	k2	J1	Ø0
CJMP-820	-	160	94.5	9
CJMP-922	-	180	128	9.5
CJMP-1025	-	205	145	9.5
CJMP-1128	-	220	170	9.5
CJMP-1231	-	240	180	11.5
CJMP-1435	133	-	159	11.5
CJMP-1640	150	-	185	11.5
CJMP-1845	164	-	202	11.5
CJMP-2050	182.5	-	250	11.5

Supplied on request: LG-0

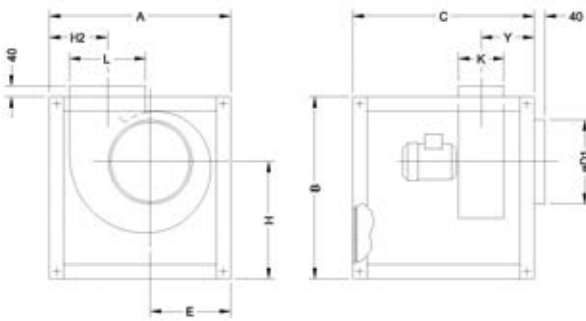

Model	A	B	C	ØD1	E	H	H2	K	L	Y
CJMP-922	610	610	610	224	279	349	197	140	215	176
CJMP-1025	660	660	660	250	302	379	214	165	250	178.5
CJMP-1128	720	720	720	280	335	409	233	180	295	191
CJMP-1231	800	800	800	315	366	459	255	200	320	205
CJMP-1435	880	880	880	355	385	514	253	230	280	291
CJMP-1640	970	970	970	400	412	564	287	250	320	324
CJMP-1845	1070	1070	1070	450	446	629	319	284	360	357
CJMP-2050	1160	1160	1160	500	485	679	362	315	450	383.5

Supplied on request: LG-90

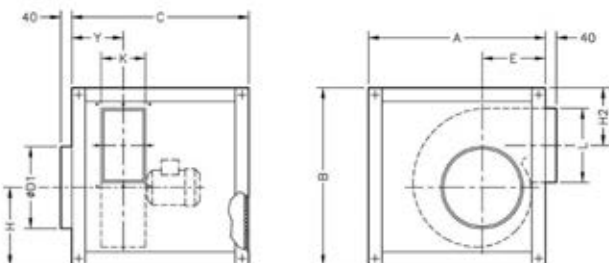

Model	A	B	C	ØD1	E	H	H2	K	L	Y
CJMP-922	720	720	720	224	187	349	237	140	215	176
CJMP-1025	800	800	800	250	204	379	277	165	250	178
CJMP-1128	880	880	880	280	223	409	319	180	295	191
CJMP-1231	970	970	970	315	245	459	332	200	320	205
CJMP-1435	1070	1070	1070	355	257	514	314	230	280	291
CJMP-1640	1160	1160	1160	400	277	564	325	250	320	325
CJMP-1845	865	1260	1050	450	309	629	326	284	360	357
CJMP-2050	965	1400	1200	500	352	679	408	315	450	383.5

Characteristic curves

Q = Airflow in m³/h, m³/s and cfm.

Pe = Static pressure in mm.w.c., Pa and inwg.

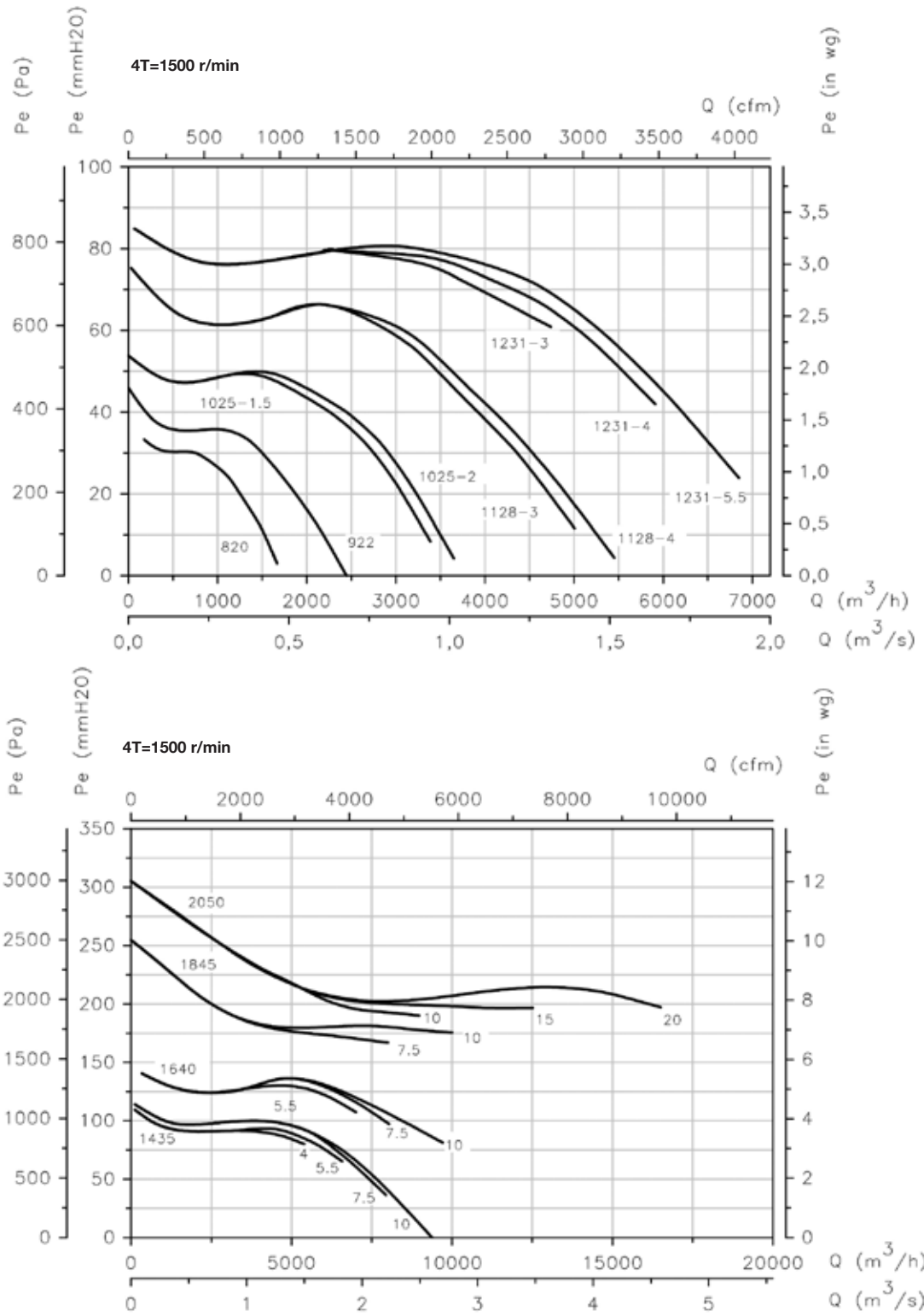

Characteristic curves

Q = Airflow in m³/h, m³/s and cfm.

Pe= Static pressure in mm.w.c., Pa and inwg.

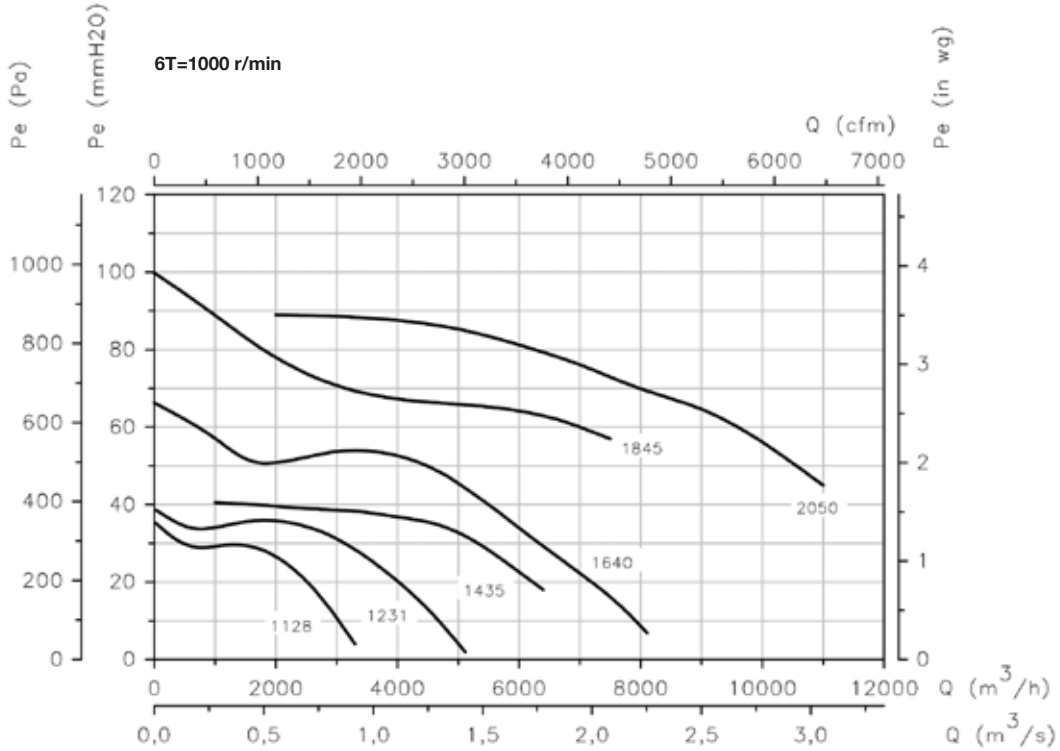

Positions

LG 270 standard supply
 LG 180 and RD 180 positions on request and with special fixing measures.



Accessories

See accessories section



CJTX-C



400°C/2h belt-driven extraction units with double-inlet fan

400°C/2h extraction units with motor and belt-driven inside the plate to work outside fire danger zones.

Fan:

- Galvanized sheet steel structure.
- Impeller with forward-facing blades made from galvanised sheet steel
- Approval according to Standard EN-12101-3-2002, certification No.: 0370-CPD-0468
- Linear air circulation

Motor:

- Class F motors with ball bearings, IP55 protection, one-or two-speed depending on the model
- Three-phase 230/400V.-50Hz. (up to 5.5CV) and 400/690V.-50Hz.(power over 5.5CV)
- Max. air temperature to transport: S1 Service -20°C+ 120°C for ongoing use, S2 Service 200°C/2h, 300°C/2h and 400°C/2h

Finish:

- Anticorrosive galvanized sheet steel

On request:

- Fans with vertical outlet



Order code

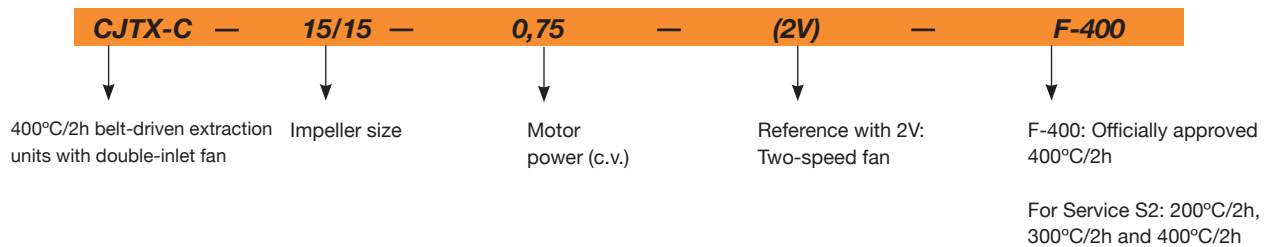

Technical characteristics

Model	Speed (r/min)	Maximum admissible current (A)			Installed power (kW)	Maximum airflow (m³/h)	Sound pressure level dB(A)	Approx. weight (Kg)
		230V	400V (A)	690V				
CJTX-C-7/7-0.25	1000	0.96	0.55		0.18	1600	58	53
CJTX-C-7/7-0.33	1200	1.90	1.10		0.25	1825	60	54
CJTX-C-7/7-0.33 2V	1200 / 600		0.70 / 0.30		0.25 / 0.10	1825 / 915	60 / 45	54
CJTX-C-7/7-0.5	1400	1.84	1.06		0.37	2100	64	54
CJTX-C-7/7-0.5 2V	1400 / 700		1.05 / 0.50		0.37 / 0.11	2100 / 1050	64 / 49	57
CJTX-C-7/7-0.75	1600	2.28	1.31		0.55	2350	67	58
CJTX-C-7/7-0.75 2V	1600 / 800		1.70 / 0.80		0.55 / 0.19	2350 / 1175	67 / 52	58
CJTX-C-7/7-1	1800	2.83	1.63		0.75	2600	69	62
CJTX-C-7/7-1 2V	1800 / 900		2.00 / 0.90		0.75 / 0.20	2600 / 1300	69 / 54	61
CJTX-C-9/9-0.33	850	1.90	1.10		0.25	2300	58	65
CJTX-C-9/9-0.33 2V	850 / 425		0.70 / 0.30		0.25 / 0.10	2300 / 1150	58 / 43	65
CJTX-C-9/9-0.5	960	1.84	1.06		0.37	2800	61	66
CJTX-C-9/9-0.5 2V	960 / 480		1.05 / 0.50		0.37 / 0.11	2800 / 1400	61 / 46	67
CJTX-C-9/9-0.75	1060	2.28	1.31		0.55	3200	65	69
CJTX-C-9/9-0.75 2V	1060 / 530		1.70 / 0.80		0.55 / 0.19	3200 / 1600	65 / 50	69
CJTX-C-9/9-1	1200	2.83	1.63		0.75	3500	67	73
CJTX-C-9/9-1 2V	1200 / 600		2.00 / 0.90		0.75 / 0.20	3500 / 1750	67 / 52	72
CJTX-C-9/9-1.5	1340	4.03	2.32		1.10	4100	70	80
CJTX-C-9/9-1.5 2V	1340 / 670		2.90 / 1.30		1.10 / 0.25	4100 / 2050	70 / 55	74
CJTX-C-9/9-2	1500	5.96	3.44		1.50	4400	72	84
CJTX-C-9/9-2 2V	1500 / 750		3.50 / 1.50		1.50 / 0.37	4400 / 2200	72 / 57	76
CJTX-C-10/10-0.33	660	1.90	1.10		0.25	2800	57	77

Technical characteristics

Model	Speed (r/min)	Maximum admissible current (A)			Installed power (kW)	Maximum airflow (m³/h)	Sound pressure level dB(A)	Approx. weight (Kg)
		230V	400V (A)	690V				
CJTX-C-10/10-0.33 2V	660 / 330		0.70 / 0.30		0.25 / 0.10	2800 / 1400	57 / 42	77
CJTX-C-10/10-0.5	800	1.84	1.06		0.37	3300	61	77
CJTX-C-10/10-0.5 2V	800 / 400		1.05 / 0.50		0.37 / 0.11	3300 / 1650	61 / 46	79
CJTX-C-10/10-0.75	880	2.28	1.31		0.55	3800	63	81
CJTX-C-10/10-0.75 2V	880 / 440		1.70 / 0.80		0.55 / 0.19	3800 / 1900	63 / 48	81
CJTX-C-10/10-1	1000	2.83	1.63		0.75	4200	65	85
CJTX-C-10/10-1 2V	1000 / 500		2.00 / 0.90		0.75 / 0.20	4200 / 2100	65 / 50	84
CJTX-C-10/10-1.5	1130	4.03	2.32		1.10	4800	68	92
CJTX-C-10/10-1.5 2V	1130 / 565		2.90 / 1.30		1.10 / 0.25	4800 / 2400	68 / 53	85
CJTX-C-10/10-2	1270	5.96	3.44		1.50	5300	71	94
CJTX-C-10/10-2 2V	1270 / 635		3.50 / 1.50		1.50 / 0.37	5300 / 2650	71 / 56	86
CJTX-C-10/10-3	1450	8.36	4.83		2.20	5900	74	89
CJTX-C-10/10-3 2V	1450 / 725		4.90 / 1.70		2.20 / 0.45	5900 / 2950	74 / 59	93
CJTX-C-12/12-0.5	600	1.84	1.06		0.37	4200	60	96
CJTX-C-12/12-0.5 2V	600 / 300		1.05 / 0.50		0.37 / 0.11	4200 / 2100	60 / 45	98
CJTX-C-12/12-0.75	700	2.28	1.31		0.55	4600	63	99
CJTX-C-12/12-0.75 2V	700 / 350		1.70 / 0.80		0.55 / 0.19	4600 / 2300	63 / 48	100
CJTX-C-12/12-1	800	2.83	1.63		0.75	5100	65	104
CJTX-C-12/12-1 2V	800 / 400		2.00 / 0.90		0.75 / 0.20	5100 / 2550	65 / 50	103
CJTX-C-12/12-1.5	880	4.03	2.32		1.10	5700	68	111
CJTX-C-12/12-1.5 2V	880 / 440		2.90 / 1.30		1.10 / 0.25	5700 / 2850	68 / 53	104
CJTX-C-12/12-2	1020	5.96	3.44		1.50	6400	70	113
CJTX-C-12/12-2 2V	1020 / 510		3.50 / 1.50		1.50 / 0.37	6400 / 3200	70 / 55	105
CJTX-C-12/12-3	1140	8.36	4.83		2.20	7400	73	107
CJTX-C-12/12-3 2V	1140 / 570		4.90 / 1.70		2.20 / 0.45	7400 / 3700	73 / 58	110
CJTX-C-12/12-4	1250	10.96	6.33		3.00	8200	75	115
CJTX-C-12/12-4 2V	1250 / 625		6.50 / 2.30		3.00 / 0.60	8200 / 4100	75 / 60	118
CJTX-C-15/15-0.75	530	2.28	1.31		0.55	4700	59	126
CJTX-C-15/15-0.75 2V	530 / 265		1.60 / 0.65		0.55 / 0.09	4700 / 2350	59 / 44	126
CJTX-C-15/15-1	560	2.83	1.63		0.75	6000	61	130
CJTX-C-15/15-1 2V	560 / 280		2.20 / 0.87		0.75 / 0.15	6000 / 3000	61 / 46	129
CJTX-C-15/15-1.5	630	4.03	2.32		1.10	7000	64	138
CJTX-C-15/15-1.5 2V	630 / 315		3.00 / 1.15		1.10 / 0.18	7000 / 3500	64 / 49	131
CJTX-C-15/15-2	700	5.96	3.44		1.50	7800	66	141
CJTX-C-15/15-2 2V	700 / 350		4.60 / 1.90		1.50 / 0.25	7800 / 3900	66 / 51	133
CJTX-C-15/15-3	800	8.36	4.83		2.20	9000	69	135
CJTX-C-15/15-3 2V	800 / 400		5.60 / 2.20		2.20 / 0.37	9000 / 4500	69 / 54	140
CJTX-C-15/15-4	880	10.96	6.33		3.00	10000	72	144
CJTX-C-15/15-4 2V	880 / 440		9.00 / 3.50		3.00 / 0.55	10000 / 5000	72 / 57	147
CJTX-C-15/15-5.5	970	14.10	8.12		4.00	11000	73	145
CJTX-C-15/15-5.5 2V	970 / 485		11.00 / 4.00		4.00 / 0.65	11000 / 5500	73 / 58	151
CJTX-C-18/18-1	460	2.83	1.63		0.75	7500	60	163
CJTX-C-18/18-1 2V	460 / 230		2.20 / 0.87		0.75 / 0.15	7500 / 3750	60 / 45	163
CJTX-C-18/18-1.5	510	4.03	2.32		1.10	9000	61	171
CJTX-C-18/18-1.5 2V	510 / 255		3.00 / 1.15		1.10 / 0.18	9000 / 4500	61 / 46	165
CJTX-C-18/18-2	540	5.96	3.44		1.50	10800	64	175
CJTX-C-18/18-2 2V	540 / 270		4.60 / 1.90		1.50 / 0.25	10800 / 5400	64 / 49	167
CJTX-C-18/18-3	610	8.36	4.83		2.20	12500	67	170
CJTX-C-18/18-3 2V	610 / 305		5.60 / 2.20		2.20 / 0.37	12500 / 6250	67 / 52	173
CJTX-C-18/18-4	680	10.96	6.33		3.00	14000	70	177
CJTX-C-18/18-4 2V	680 / 340		9.00 / 3.50		3.00 / 0.55	14000 / 7000	70 / 55	180
CJTX-C-18/18-5.5	750	14.10	8.12		4.00	15000	72	178
CJTX-C-18/18-5.5 2V	750 / 375		11.00 / 4.00		4.00 / 0.65	15000 / 7500	72 / 57	184
CJTX-C-18/18-7.5	850		11.60	6.72	5.50	16500	74	188
CJTX-C-18/18-7.5 2V	850 / 425		13.20 / 5.30		5.50 / 1.00	16500 / 8250	74 / 59	204
CJTX-C-18/18-10	930		14.20	8.20	7.50	18000	77	202
CJTX-C-18/18-10 2V	930 / 465		16.90 / 5.50		7.50 / 1.30	18000 / 9000	77 / 62	213
CJTX-C-20/20-2	450	5.96	3.44		1.50	13000	64	276
CJTX-C-20/20-2 2V	450 / 225		4.60 / 1.90		1.50 / 0.25	13000 / 6500	64 / 49	268
CJTX-C-20/20-3	530	8.36	4.83		2.20	15000	68	270
CJTX-C-20/20-3 2V	530 / 265		5.60 / 2.20		2.20 / 0.37	15000 / 7500	68 / 53	274
CJTX-C-20/20-4	580	10.96	6.33		3.00	16300	70	277
CJTX-C-20/20-4 2V	580 / 290		9.00 / 3.50		3.00 / 0.55	16300 / 8150	70 / 55	280
CJTX-C-20/20-5.5	660	14.10	8.12		4.00	18000	72	279

Technical characteristics

Model	Speed (r/min)	Maximum admissible current (A)			Installed power (kW)	Maximum airflow (m³/h)	Sound pressure level dB(A)	Approx. weight (Kg)
		230V	400V (A)	690V				
CJTX-C-20/20-5.5 2V	660 / 330		11.00 / 4.00		4.00 / 0.65	18000 / 9000	72 / 57	285
CJTX-C-20/20-7.5	740		11.60	6.72	5.50	20500	74	289
CJTX-C-20/20-7.5 2V	740 / 370		13.20 / 5.30		5.50 / 1.00	20500 / 10250	74 / 59	305
CJTX-C-20/20-10	815		14.20	8.20	7.50	22500	77	304
CJTX-C-20/20-10 2V	815 / 407.5		16.90 / 5.50		7.50 / 1.30	22500 / 11250	77 / 62	314
CJTX-C-22/22-2	380	5.96	3.44		1.50	14000	62	318
CJTX-C-22/22-2 2V	380 / 190		4.60 / 1.90		1.50 / 0.25	14000 / 7000	62 / 47	310
CJTX-C-22/22-3	430	8.36	4.83		2.20	16000	64	312
CJTX-C-22/22-3 2V	430 / 215		5.60 / 2.20		2.20 / 0.37	16000 / 8000	64 / 49	316
CJTX-C-22/22-4	480	10.96	6.33		3.00	18000	68	320
CJTX-C-22/22-4 2V	480 / 240		9.00 / 3.50		3.00 / 0.55	18000 / 9000	68 / 53	323
CJTX-C-22/22-5.5	520	14.10	8.12		4.00	20000	69	323
CJTX-C-22/22-5.5 2V	520 / 260		11.00 / 4.00		4.00 / 0.65	20000 / 10000	69 / 54	329
CJTX-C-22/22-7.5	580		11.60	6.72	5.50	22500	72	333
CJTX-C-22/22-7.5 2V	580 / 290		13.20 / 5.30		5.50 / 1.00	22500 / 11250	72 / 57	350
CJTX-C-22/22-10	650		14.20	8.20	7.50	25000	74	346
CJTX-C-22/22-10 2V	650 / 325		16.90 / 5.50		7.50 / 1.30	25000 / 12500	74 / 59	357
CJTX-C-22/22-15	740		20.20	11.60	11.00	28000	77	358
CJTX-C-22/22-15 2V	740 / 370		23.20 / 8.70		11.00 / 2.80	28000 / 14000	77 / 62	389
CJTX-C-22/22-20	780		29.80	17.30	15.00	31000	79	424
CJTX-C-22/22-20 2V	780 / 390		31.72 / 11.75		15.00 / 3.80	31000 / 15500	79 / 64	413
CJTX-C-25/25-3	340	8.36	4.83		2.20	20000	66	369
CJTX-C-25/25-3 2V	340 / 170		5.60 / 2.20		2.20 / 0.37	20000 / 10000	66 / 51	372
CJTX-C-25/25-4	380	10.96	6.33		3.00	22000	68	376
CJTX-C-25/25-4 2V	380 / 190		9.00 / 3.50		3.00 / 0.55	22000 / 11000	68 / 53	379
CJTX-C-25/25-5.5	420	14.10	8.12		4.00	24000	70	377
CJTX-C-25/25-5.5 2V	420 / 210		11.00 / 4.00		4.00 / 0.65	24000 / 12000	70 / 55	383
CJTX-C-25/25-7.5	470		11.60	6.72	5.50	26500	73	393
CJTX-C-25/25-7.5 2V	470 / 235		13.20 / 5.30		5.50 / 1.00	26500 / 13250	73 / 58	409
CJTX-C-25/25-10	510		14.20	8.20	7.50	29000	75	401
CJTX-C-25/25-10 2V	510 / 255		16.90 / 5.50		7.50 / 1.30	29000 / 14500	75 / 60	412
CJTX-C-25/25-15	570		20.20	11.60	11.00	34000	78	419
CJTX-C-25/25-15 2V	570 / 285		23.20 / 8.70		11.00 / 2.80	34000 / 17000	78 / 63	450
CJTX-C-25/25-20	630		29.80	17.30	15.00	38000	80	482
CJTX-C-25/25-20 2V	630 / 315		31.72 / 11.75		15.00 / 3.80	38000 / 19000	80 / 65	471
CJTX-C-30/28-3	250	8.36	4.83		2.20	25000	64	502
CJTX-C-30/28-3 2V	250 / 125		5.60 / 2.20		2.20 / 0.37	25000 / 12500	64 / 49	507
CJTX-C-30/28-4	280	10.96	6.33		3.00	27000	66	516
CJTX-C-30/28-4 2V	280 / 140		9.00 / 3.50		3.00 / 0.55	27000 / 13500	66 / 51	519
CJTX-C-30/28-5.5	340	14.10	8.12		4.00	29000	68	517
CJTX-C-30/28-5.5 2V	340 / 170		11.00 / 4.00		4.00 / 0.65	29000 / 14500	68 / 53	523
CJTX-C-30/28-7.5	360		11.60	6.72	5.50	32500	71	530
CJTX-C-30/28-7.5 2V	360 / 180		13.20 / 5.30		5.50 / 1.00	32500 / 16250	71 / 56	546
CJTX-C-30/28-10	410		14.20	8.20	7.50	36000	73	545
CJTX-C-30/28-10 2V	410 / 205		16.90 / 5.50		7.50 / 1.30	36000 / 18000	73 / 58	556
CJTX-C-30/28-15	480		20.20	11.60	11.00	40000	76	557
CJTX-C-30/28-15 2V	480 / 240		23.20 / 8.70		11.00 / 2.80	40000 / 20000	76 / 61	588
CJTX-C-30/28-20	520		29.80	17.30	15.00	45000	78	627
CJTX-C-30/28-20 2V	520 / 260		31.72 / 11.75		15.00 / 3.80	45000 / 22500	78 / 63	616
CJTX-C-30/28-25	550		35.00	20.00	18.50	49000	79	609
CJTX-C-30/28-25 2V	550 / 275		33.00 / 11.00		17.00 / 3.40	49000 / 24500	79 / 64	643



Erp. BEP (best efficiency point) characteristics

MC	Measurement category	ηe[%]	Efficiency
EC	Efficiency category	N	Efficiency grade
S	Static	[kW]	Input power
T	Total	[m³/h]	Airflow
VSD	Variable-speed drive	[mmH₂O]	Static or total pressure (According to EC)
SR	Specific ratio	[RPM]	Speed

Model	MC	EC	VSD	SR	ηe[%]	N	(kW)	(m³/h)	(mmH ₂ O)	(RPM)
CJTX-C-7/7-0.25	C	S	NO	1.00	28.3%	40.5	0.114	907	13.07	1000
CJTX-C-7/7-0.33	C	S	NO	1.00	32.0%	43.1	0.174	1088	18.82	1200
CJTX-C-7/7-0.33 -2V	C	S	NO	1.00	29.5%	40.4	0.189	1088	18.82	1200
CJTX-C-7/7-0.5	C	S	NO	1.00	31.5%	41.3	0.281	1269	25.61	1400
CJTX-C-7/7-0.5 -2V	C	S	NO	1.00	31.8%	41.7	0.278	1269	25.61	1400
CJTX-C-7/7-0.75	C	S	NO	1.00	34.3%	43.2	0.385	1450	33.45	1600
CJTX-C-7/7-0.75 -2V	C	S	NO	1.00	30.9%	39.6	0.428	1450	33.45	1600
CJTX-C-7/7-1	C	S	NO	1.00	37.1%	45.3	0.508	1632	42.33	1800
CJTX-C-7/7-1 -2V	C	S	NO	1.00	31.7%	39.5	0.593	1632	42.33	1800
CJTX-C-9/9-0.33	C	S	NO	1.00	37.7%	49.5	0.138	1293	14.74	850
CJTX-C-9/9-0.33 -2V	C	S	NO	1.00	34.8%	46.3	0.149	1293	14.74	850
CJTX-C-9/9-0.5	C	S	NO	1.00	37.2%	47.9	0.201	1460	18.80	960
CJTX-C-9/9-0.5 -2V	C	S	NO	1.00	37.6%	48.3	0.199	1460	18.80	960
CJTX-C-9/9-0.75	C	S	NO	1.00	40.5%	50.6	0.249	1612	22.92	1060
CJTX-C-9/9-0.75 -2V	C	S	NO	1.00	36.5%	46.3	0.276	1612	22.92	1060
CJTX-C-9/9-1	C	S	NO	1.00	43.8%	53.1	0.334	1825	29.38	1200
CJTX-C-9/9-1 -2V	C	S	NO	1.00	37.5%	46.4	0.390	1825	29.38	1200
CJTX-C-9/9-1.5	C	S	NO	1.00	44.9%	53.4	0.453	2038	36.63	1340
CJTX-C-9/9-1.5 -2V	C	S	NO	1.00	38.4%	46.5	0.530	2038	36.63	1340
CJTX-C-9/9-2	C	S	NO	1.00	45.3%	52.9	0.630	2281	45.90	1500
CJTX-C-9/9-2 -2V	C	S	NO	1.00	39.8%	47.1	0.716	2281	45.90	1500
CJTX-C-10/10-0.33	C	S	NO	1.00	31.9%	42.5	0.210	1575	15.63	660
CJTX-C-10/10-0.33 -2V	C	S	NO	1.00	29.4%	39.8	0.228	1575	15.63	660
CJTX-C-10/10-0.5	C	S	NO	1.00	31.5%	40.4	0.380	1909	22.97	800
CJTX-C-10/10-0.5 -2V	C	S	NO	1.00	31.8%	40.8	0.376	1909	22.97	800
CJTX-C-10/10-0.75	C	S	NO	1.00	34.2%	42.7	0.465	2100	27.79	880
CJTX-C-10/10-0.75 -2V	C	S	NO	1.00	30.9%	39.0	0.515	2100	27.79	880
CJTX-C-10/10-1	C	S	NO	1.00	37.0%	44.6	0.631	2387	35.89	1000
CJTX-C-10/10-1 -2V	C	S	NO	1.00	31.7%	38.9	0.736	2387	35.89	1000
CJTX-C-10/10-1.5	C	S	NO	1.00	37.9%	44.6	0.888	2697	45.83	1130
CJTX-C-10/10-1.5 -2V	C	S	NO	1.00	32.5%	38.7	1.037	2697	45.83	1130
CJTX-C-10/10-2	C	S	NO	1.01	38.3%	44.0	1.248	3031	57.89	1270
CJTX-C-10/10-2 -2V	C	S	NO	1.01	33.7%	39.1	1.419	3031	57.89	1270
CJTX-C-10/10-3	C	S	NO	1.01	39.0%	43.7	1.824	3461	75.46	1450
CJTX-C-10/10-3 -2V	C	S	NO	1.01	34.9%	39.3	2.040	3461	75.46	1450
CJTX-C-12/12-0.5	C	S	NO	1.00	33.1%	43.0	0.266	2423	13.33	600
CJTX-C-12/12-0.5 -2V	C	S	NO	1.00	33.4%	43.4	0.263	2423	13.33	600
CJTX-C-12/12-0.75	C	S	NO	1.00	36.0%	44.9	0.388	2827	18.15	700
CJTX-C-12/12-0.75 -2V	C	S	NO	1.00	32.5%	41.1	0.431	2827	18.15	700
CJTX-C-12/12-1	C	S	NO	1.00	38.9%	47.0	0.536	3231	23.70	800
CJTX-C-12/12-1 -2V	C	S	NO	1.00	33.3%	40.9	0.626	3231	23.70	800
CJTX-C-12/12-1.5	C	S	NO	1.00	39.9%	47.2	0.696	3554	28.68	880
CJTX-C-12/12-1.5 -2V	C	S	NO	1.00	34.2%	41.1	0.813	3554	28.68	880
CJTX-C-12/12-2	C	S	NO	1.00	40.3%	46.4	1.074	4119	38.53	1020
CJTX-C-12/12-2 -2V	C	S	NO	1.00	35.4%	41.2	1.221	4119	38.53	1020
CJTX-C-12/12-3	C	S	NO	1.01	41.0%	46.3	1.472	4604	48.13	1140
CJTX-C-12/12-3 -2V	C	S	NO	1.01	36.7%	41.7	1.646	4604	48.13	1140
CJTX-C-12/12-4	C	S	NO	1.01	41.6%	46.2	1.914	5048	57.87	1250
CJTX-C-12/12-4 -2V	C	S	NO	1.01	37.7%	42.0	2.111	5048	57.87	1250
CJTX-C-15/15-0.75	C	S	NO	1.00	35.7%	44.2	0.465	3849	15.85	530
CJTX-C-15/15-0.75 -2V	C	S	NO	1.00	32.4%	40.5	0.514	3849	15.85	530
CJTX-C-15/15-1	C	S	NO	1.00	38.6%	46.8	0.508	4067	17.70	560
CJTX-C-15/15-1 -2V	C	S	NO	1.00	32.6%	40.3	0.603	4067	17.70	560
CJTX-C-15/15-1.5	C	S	NO	1.00	39.6%	46.9	0.705	4576	22.40	630
CJTX-C-15/15-1.5 -2V	C	S	NO	1.00	34.1%	41.0	0.819	4576	22.40	630
CJTX-C-15/15-2	C	S	NO	1.00	40.0%	46.4	0.958	5084	27.66	700
CJTX-C-15/15-2 -2V	C	S	NO	1.00	35.5%	41.6	1.079	5084	27.66	700
CJTX-C-15/15-3	C	S	NO	1.00	40.7%	46.1	1.404	5810	36.12	800
CJTX-C-15/15-3 -2V	C	S	NO	1.00	35.6%	40.6	1.609	5810	36.12	800

Facts internal fan without box



Erp. BEP (best efficiency point) characteristics

MC	Measurement category	η_e[%]	Efficiency
EC	Efficiency category	N	Efficiency grade
S	Static	[kW]	Input power
T	Total	[m³/h]	Airflow
VSD	Variable-speed drive	[mmH₂O]	Static or total pressure (According to EC)
SR	Specific ratio	[RPM]	Speed

Model	MC	EC	VSD	SR	η_e [%]	N	(kW)	(m ³ /h)	(mmH ₂ O)	(RPM)
CJTX-C-15/15-4	C	S	NO	1.00	41.3%	46.0	1.843	6391	43.71	880
CJTX-C-15/15-4 -2V	C	S	NO	1.00	35.2%	39.4	2.162	6391	43.71	880
CJTX-C-15/15-5.5	C	S	NO	1.01	42.0%	45.9	2.426	7045	53.11	970
CJTX-C-15/15-5.5 -2V	C	S	NO	1.01	37.8%	41.4	2.695	7045	53.11	970
CJTX-C-18/18-1	C	S	NO	1.00	46.1%	52.9	0.836	6738	21.01	460
CJTX-C-18/18-1 -2V	C	S	NO	1.00	38.9%	45.2	0.993	6738	21.01	460
CJTX-C-18/18-1.5	C	S	NO	1.00	47.3%	53.3	1.112	7471	25.82	510
CJTX-C-18/18-1.5 -2V	C	S	NO	1.00	40.7%	46.3	1.291	7471	25.82	510
CJTX-C-18/18-2	C	S	NO	1.00	47.7%	53.3	1.307	7910	28.95	540
CJTX-C-18/18-2 -2V	C	S	NO	1.00	42.4%	47.6	1.472	7910	28.95	540
CJTX-C-18/18-3	C	S	NO	1.00	48.6%	53.2	1.851	8935	36.94	610
CJTX-C-18/18-3 -2V	C	S	NO	1.00	42.4%	46.7	2.120	8935	36.94	610
CJTX-C-18/18-4	C	S	NO	1.01	49.3%	53.1	2.528	9961	45.91	680
CJTX-C-18/18-4 -2V	C	S	NO	1.01	42.0%	45.4	2.965	9961	45.91	680
CJTX-C-18/18-5.5	C	S	NO	1.01	50.2%	53.2	3.333	10986	55.85	750
CJTX-C-18/18-5.5 -2V	C	S	NO	1.01	45.1%	47.9	3.703	10986	55.85	750
CJTX-C-18/18-7.5	C	S	NO	1.01	50.7%	52.8	4.797	12451	71.73	850
CJTX-C-18/18-7.5 -2V	C	S	NO	1.01	47.5%	49.4	5.123	12451	71.73	850
CJTX-C-18/18-10	C	S	NO	1.01	51.1%	52.5	6.233	13623	85.87	930
CJTX-C-18/18-10 -2V	C	S	NO	1.01	47.3%	48.4	6.734	13623	85.87	930
CJTX-C-20/20-2	C	S	NO	1.00	40.0%	46.4	0.987	7226	20.05	450
CJTX-C-20/20-2 -2V	C	S	NO	1.00	35.5%	41.6	1.112	7226	20.05	450
CJTX-C-20/20-3	C	S	NO	1.00	40.7%	45.8	1.583	8511	27.81	530
CJTX-C-20/20-3 -2V	C	S	NO	1.00	35.6%	40.3	1.814	8511	27.81	530
CJTX-C-20/20-4	C	S	NO	1.00	41.3%	45.7	2.046	9314	33.30	580
CJTX-C-20/20-4 -2V	C	S	NO	1.00	35.2%	39.2	2.400	9314	33.30	580
CJTX-C-20/20-5.5	C	S	NO	1.00	42.0%	45.4	2.963	10598	43.13	660
CJTX-C-20/20-5.5 -2V	C	S	NO	1.00	37.8%	40.9	3.292	10598	43.13	660
CJTX-C-20/20-7.5	C	S	NO	1.01	42.5%	45.0	4.129	11883	54.21	740
CJTX-C-20/20-7.5 -2V	C	S	NO	1.01	39.8%	42.1	4.409	11883	54.21	740
CJTX-C-20/20-10	C	S	NO	1.01	42.9%	44.5	5.472	13087	65.76	815
CJTX-C-20/20-10 -2V	C	S	NO	1.01	39.7%	41.1	5.912	13087	65.76	815
CJTX-C-22/22-2	C	S	NO	1.00	41.9%	48.4	0.936	8293	17.33	380
CJTX-C-22/22-2 -2V	C	S	NO	1.00	37.2%	43.3	1.054	8293	17.33	380
CJTX-C-22/22-3	C	S	NO	1.00	42.6%	48.2	1.331	9385	22.19	430
CJTX-C-22/22-3 -2V	C	S	NO	1.00	37.2%	42.4	1.525	9385	22.19	430
CJTX-C-22/22-4	C	S	NO	1.00	43.2%	47.9	1.826	10476	27.65	480
CJTX-C-22/22-4 -2V	C	S	NO	1.00	36.9%	41.1	2.142	10476	27.65	480
CJTX-C-22/22-5.5	C	S	NO	1.00	44.0%	48.1	2.282	11349	32.45	520
CJTX-C-22/22-5.5 -2V	C	S	NO	1.00	39.6%	43.4	2.535	11349	32.45	520
CJTX-C-22/22-7.5	C	S	NO	1.00	44.5%	47.7	3.130	12658	40.37	580
CJTX-C-22/22-7.5 -2V	C	S	NO	1.00	41.7%	44.7	3.343	12658	40.37	580
CJTX-C-22/22-10	C	S	NO	1.01	44.8%	47.1	4.371	14186	50.71	650
CJTX-C-22/22-10 -2V	C	S	NO	1.01	41.5%	43.6	4.722	14186	50.71	650
CJTX-C-22/22-15	C	S	NO	1.01	45.4%	46.7	6.370	16150	65.72	740
CJTX-C-22/22-15 -2V	C	S	NO	1.01	43.3%	44.4	6.687	16150	65.72	740
CJTX-C-22/22-20	C	S	NO	1.01	46.0%	46.9	7.362	17023	73.02	780
CJTX-C-22/22-20 -2V	C	S	NO	1.01	43.1%	43.8	7.852	17023	73.02	780
CJTX-C-25/25-3	C	S	NO	1.00	40.6%	46.2	1.310	11456	17.04	340
CJTX-C-25/25-3 -2V	C	S	NO	1.00	35.5%	40.7	1.500	11456	17.04	340
CJTX-C-25/25-4	C	S	NO	1.00	41.2%	45.9	1.803	12804	21.28	380
CJTX-C-25/25-4 -2V	C	S	NO	1.00	35.1%	39.4	2.115	12804	21.28	380
CJTX-C-25/25-5.5	C	S	NO	1.00	41.9%	45.8	2.392	14152	26.00	420
CJTX-C-25/25-5.5 -2V	C	S	NO	1.00	37.7%	41.4	2.658	14152	26.00	420
CJTX-C-25/25-7.5	C	S	NO	1.00	42.4%	45.4	3.314	15837	32.56	470
CJTX-C-25/25-7.5 -2V	C	S	NO	1.00	39.7%	42.6	3.540	15837	32.56	470
CJTX-C-25/25-10	C	S	NO	1.00	42.7%	45.1	4.201	17184	38.34	510
CJTX-C-25/25-10 -2V	C	S	NO	1.00	39.5%	41.7	4.539	17184	38.34	510
CJTX-C-25/25-15	C	S	NO	1.01	43.3%	44.8	5.794	19206	47.89	570

Facts internal fan without box



Erp. BEP (best efficiency point) characteristics

MC	Measurement category	ηe[%]	Efficiency
EC	Efficiency category	N	Efficiency grade
S	Static	[kW]	Input power
T	Total	[m³/h]	Airflow
VSD	Variable-speed drive	[mmH₂O]	Static or total pressure (According to EC)
SR	Specific ratio	[RPM]	Speed

Model	MC	EC	VSD	SR	ηe[%]	N	(kW)	(m³/h)	(mmH ₂ O)	(RPM)
CJTX-C-25/25-15 -2V	C	S	NO	1.01	41.2%	42.6	6.082	19206	47.89	570
CJTX-C-25/25-20	C	S	NO	1.01	43.8%	44.6	7.719	21228	58.50	630
CJTX-C-25/25-20 -2V	C	S	NO	1.01	41.1%	41.7	8.233	21228	58.50	630
CJTX-C-30/28-3	C	S	NO	1.00	42.2%	47.7	1.376	14691	14.51	250
CJTX-C-30/28-3 -2V	C	S	NO	1.00	36.9%	41.9	1.576	14691	14.51	250
CJTX-C-30/28-4	C	S	NO	1.00	42.8%	47.4	1.906	16453	18.20	280
CJTX-C-30/28-4 -2V	C	S	NO	1.00	36.5%	40.6	2.235	16453	18.20	280
CJTX-C-30/28-5.5	C	S	NO	1.00	43.6%	46.6	3.354	19979	26.83	340
CJTX-C-30/28-5.5 -2V	C	S	NO	1.00	39.2%	41.9	3.726	19979	26.83	340
CJTX-C-30/28-7.5	C	S	NO	1.00	44.1%	46.6	3.936	21154	30.08	360
CJTX-C-30/28-7.5 -2V	C	S	NO	1.00	41.3%	43.7	4.203	21154	30.08	360
CJTX-C-30/28-10	C	S	NO	1.00	44.4%	45.9	5.768	24092	39.02	410
CJTX-C-30/28-10 -2V	C	S	NO	1.00	41.1%	42.4	6.232	24092	39.02	410
CJTX-C-30/28-15	C	S	NO	1.01	45.0%	45.2	9.142	28206	53.48	480
CJTX-C-30/28-15 -2V	C	S	NO	1.01	42.8%	43.0	9.597	28206	53.48	480
CJTX-C-30/28-20	C	S	NO	1.01	45.6%	45.5	11.471	30556	62.77	520
CJTX-C-30/28-20 -2V	C	S	NO	1.01	42.7%	42.6	12.234	30556	62.77	520
CJTX-C-30/28-25	C	S	NO	1.01	45.1%	44.9	13.723	32319	70.22	550
CJTX-C-30/28-25 -2V	C	S	NO	1.01	46.5%	46.4	13.289	32319	70.22	550

Facts internal fan without box

Dimensions in mm

Standard supply horizontal outlet (H): LG-90

VIEWED FROM THE TOP

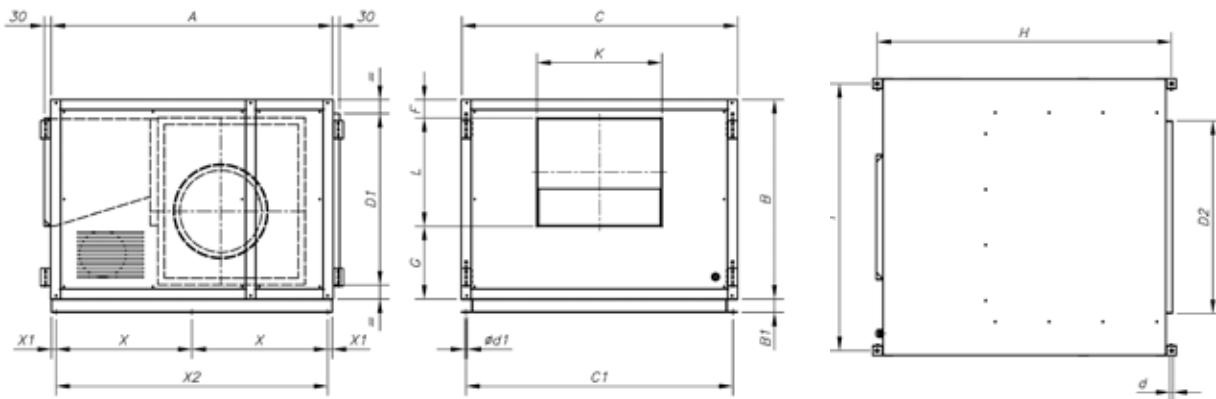

	A	B	B1	C	C1	ød	ød1	D1	D2	F	G	H	I	K	L	X	X1	X2
CJTX-C-7/7	700	480	-	730	695	10.5	9	354	470	62	202	750	685	239	216	-	-	-
CJTX-C-9/9	785	592	-	759	716	10.5	9	466	490	92	230	835	714	305	270	-	-	-
CJTX-C-10/10	860	618	-	825	782	10.5	9	492	520	87	235	910	780	334	296	-	-	-
CJTX-C-12/12	970	680	-	945	902	10.5	9	554	620	80	250	1020	900	395	350	-	-	-
CJTX-C-15/15	1100	776	-	1100	1057	10.5	9	650	720	80	285	1150	1055	483	411	-	-	-
CJTX-C-18/18	1278	900	60	1250	1207	10.5	11	774	870	95	325	1328	1205	552	480	614.5	20	1229
CJTX-C-20/20	1495	1050	60	1474	1431	13	11	954	1100	122	347	1555	1419	611	611	722.5	20	1545
CJTX-C-22/22	1640	1180	60	1625	1582	13	11	1054	1250	125	350	1700	1570	665	705	795.5	20	1591
CJTX-C-25/25	1800	1300	60	1825	1782	13	11	1174	1450	125	369	1860	1770	775	806	875.5	20	1751
CJTX-C-30/28	2000	1525	60	2134	2091	13	11	1399	1760	118	465	2060	2079	900	942	975.5	20	1951

Dimensions in mm

Supplied on request: Vertical outlet (V): LG-0

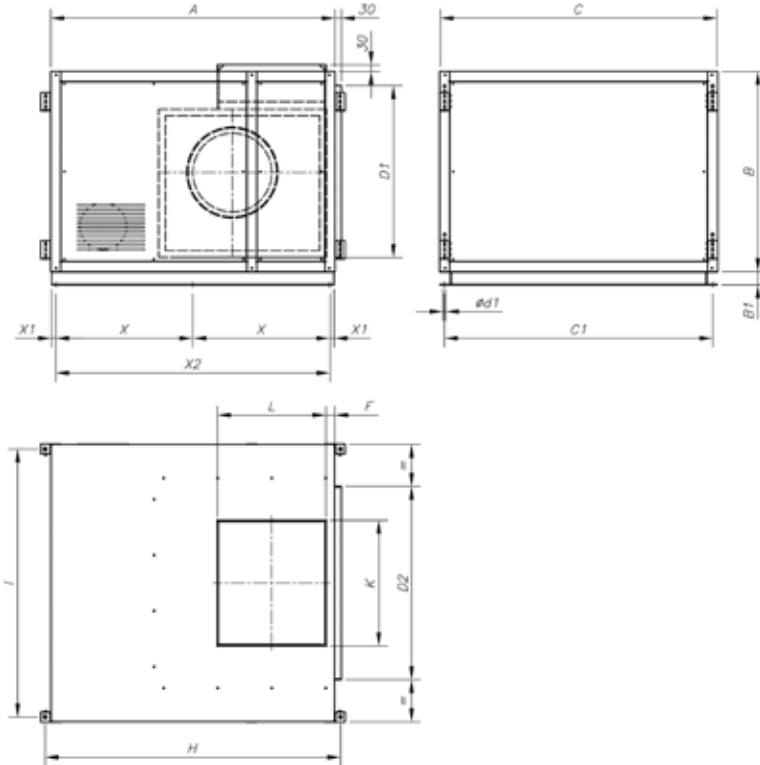

	A	B	B1	C	C1	Ød	Ød1	D1	D2	F	H	I	K	L	X	X1	X2
CJTX-C-7/7	700	480	-	730	695	10.5	9	354	470	165	750	685	238	210	-	-	-
CJTX-C-9/9	785	592	-	759	716	10.5	9	466	490	157	835	714	312	272	-	-	-
CJTX-C-10/10	860	618	-	825	782	10.5	9	492	520	135	910	780	333	300	-	-	-
CJTX-C-12/12	970	680	-	945	902	10.5	9	554	620	183	1020	900	397	355	-	-	-
CJTX-C-15/15	1100	776	-	1100	1057	10.5	9	650	720	197	1150	1055	479	421	-	-	-
CJTX-C-18/18	1278	900	60	1250	1207	10.5	11	774	870	281	1328	1205	550	495	614.5	20	1229
CJTX-C-20/20	1495	1050	60	1474	1431	13	11	954	1100	283	1555	1419	610	611	722.5	20	1545
CJTX-C-22/22	1640	1180	60	1625	1582	13	11	1054	1250	325	1700	1570	666	701	795.5	20	1591
CJTX-C-25/25	1800	1300	60	1825	1782	13	11	1174	1450	367	1860	1770	775	798	875.5	20	1751
CJTX-C-30/28	2000	1525	60	2134	2091	13	11	1399	1760	407	2060	2079	894	947	975.5	20	1951

Characteristic curves

Q = Airflow in m³/h, m³/s and cfm.

Pe= Static pressure in mm.w.c., Pa and inwg.

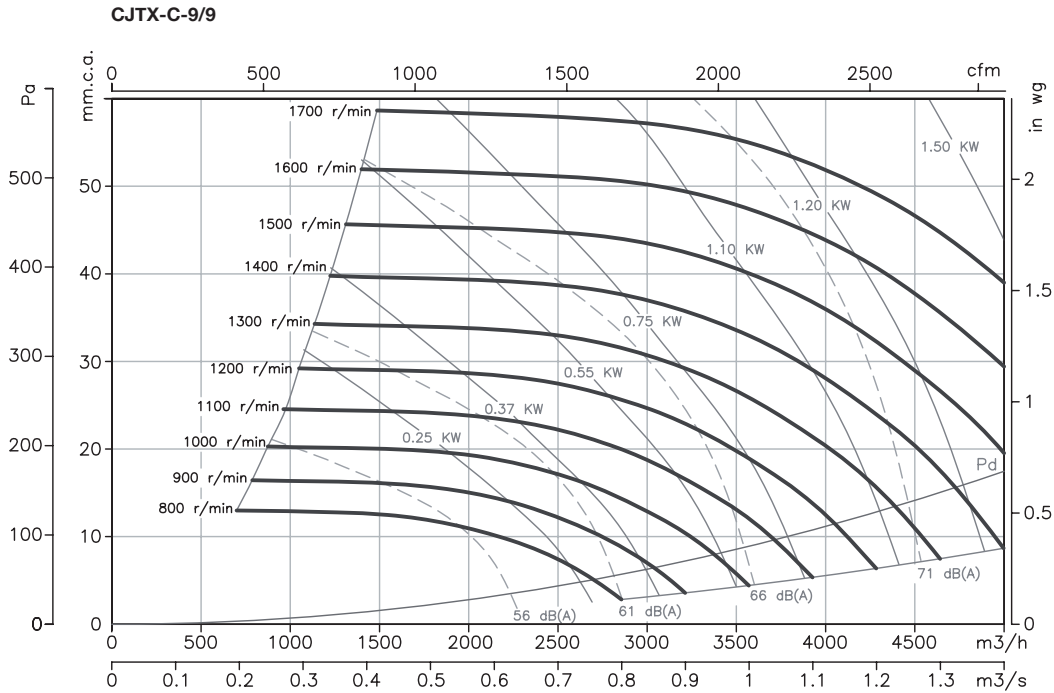
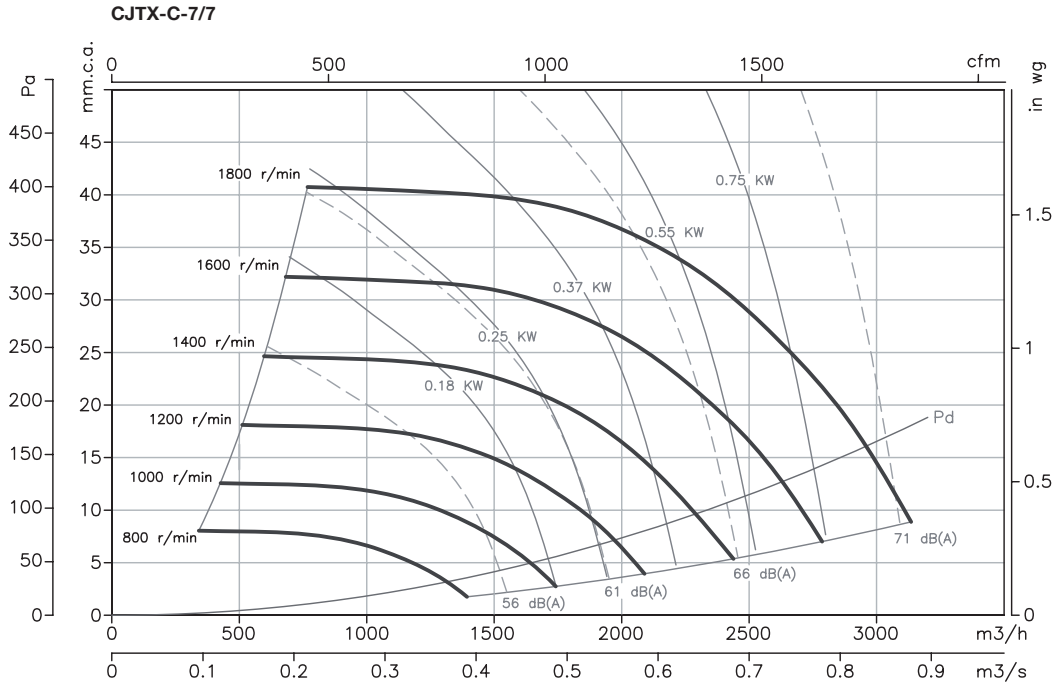

Characteristic curves

Q = Airflow in m³/h, m³/s and cfm.

Pe = Static pressure in mm.w.c., Pa and inwg.

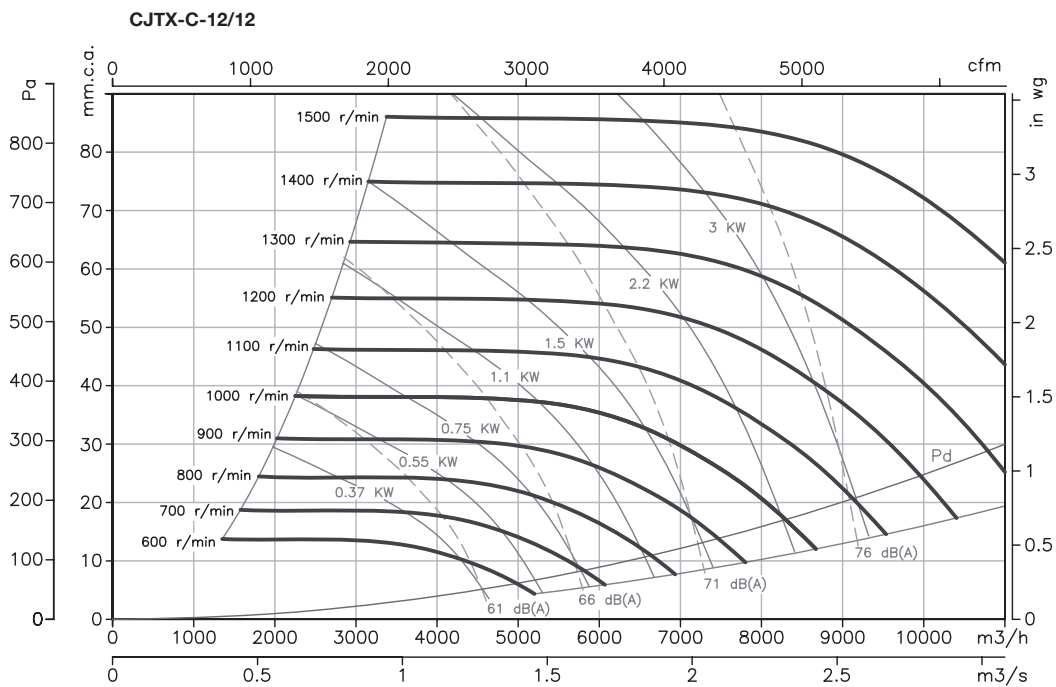
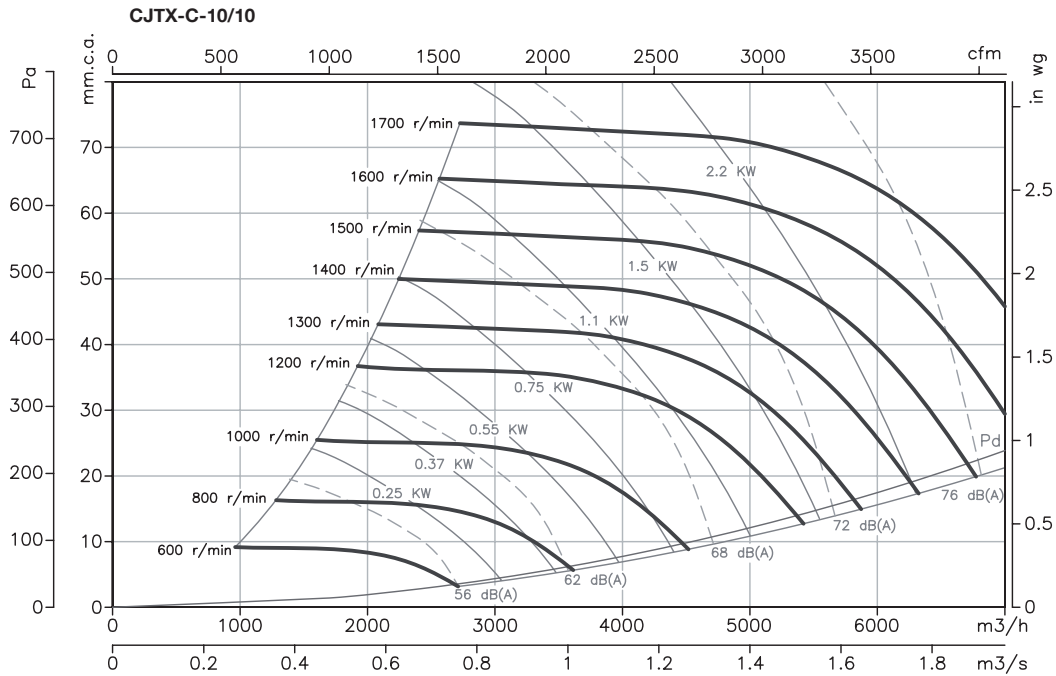

Characteristic curves

Q = Airflow in m³/h, m³/s and cfm.

Pe= Static pressure in mm.w.c., Pa and inwg.

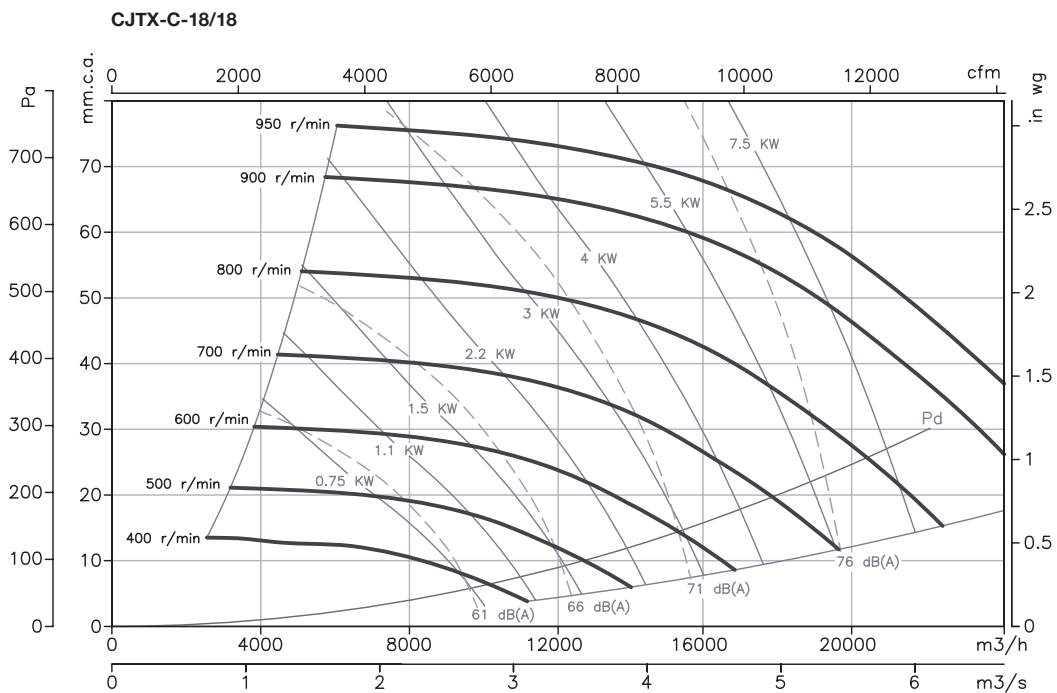
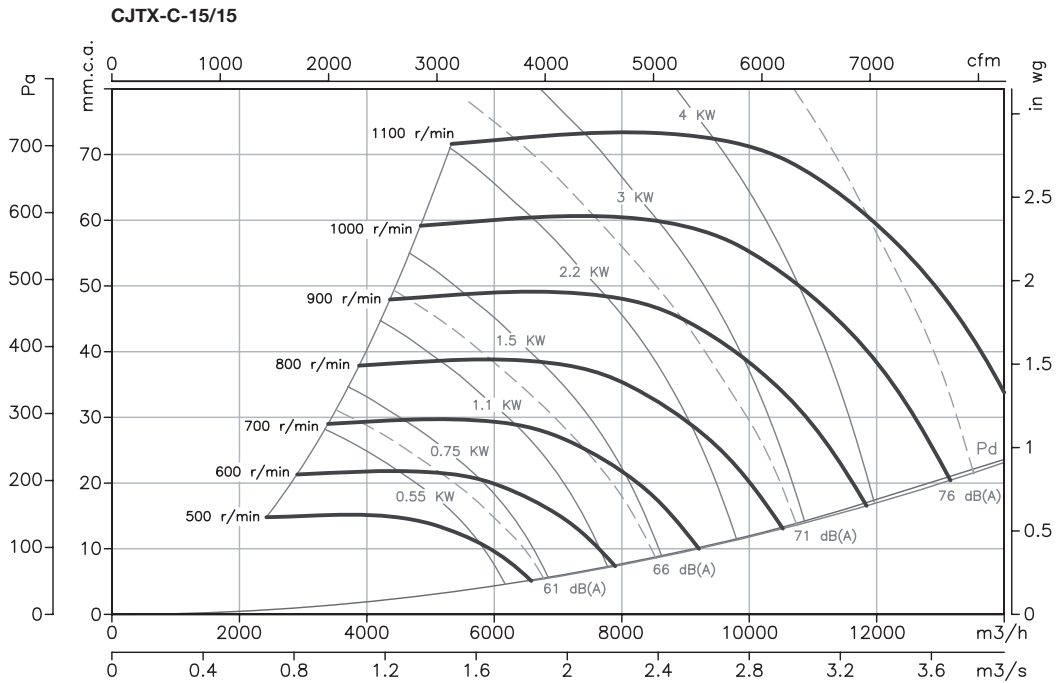

Characteristic curves

Q = Airflow in m³/h, m³/s and cfm.

Pe = Static pressure in mm.w.c., Pa and inwg.

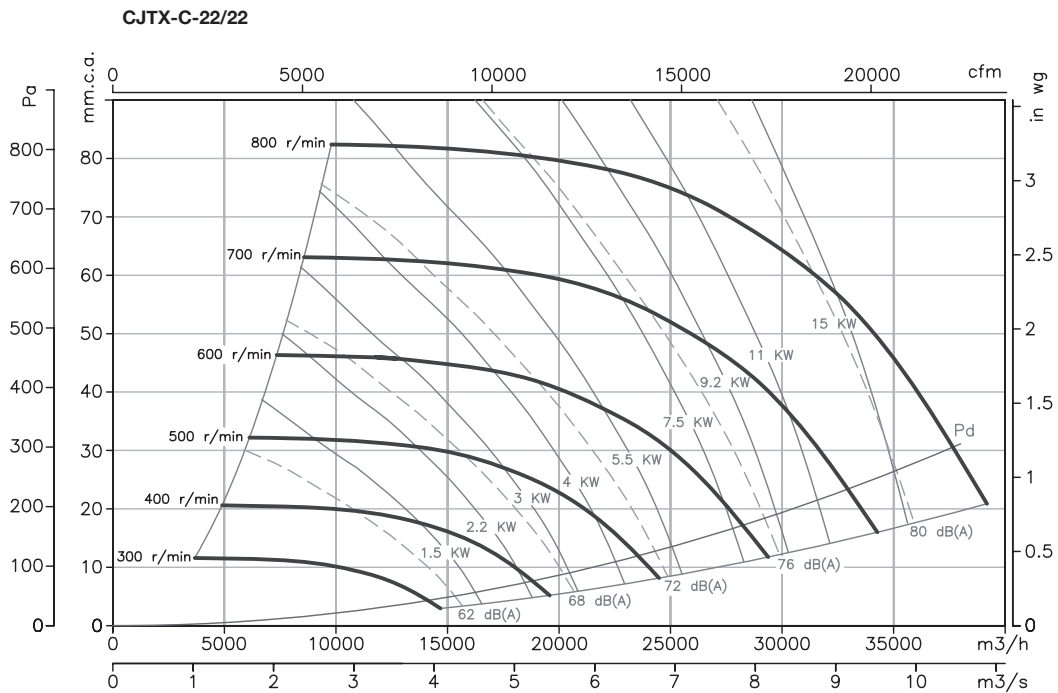
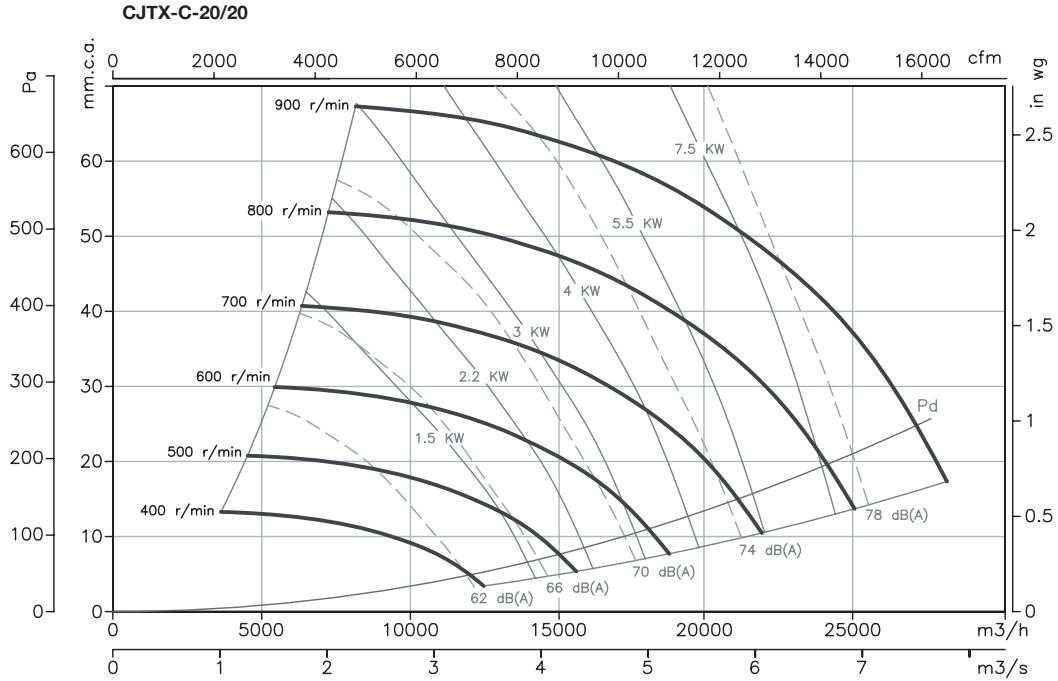

Characteristic curves

Q = Airflow in m³/h, m³/s and cfm.

Pe= Static pressure in mm.w.c., Pa and inwg.

CJTX-C-25/25

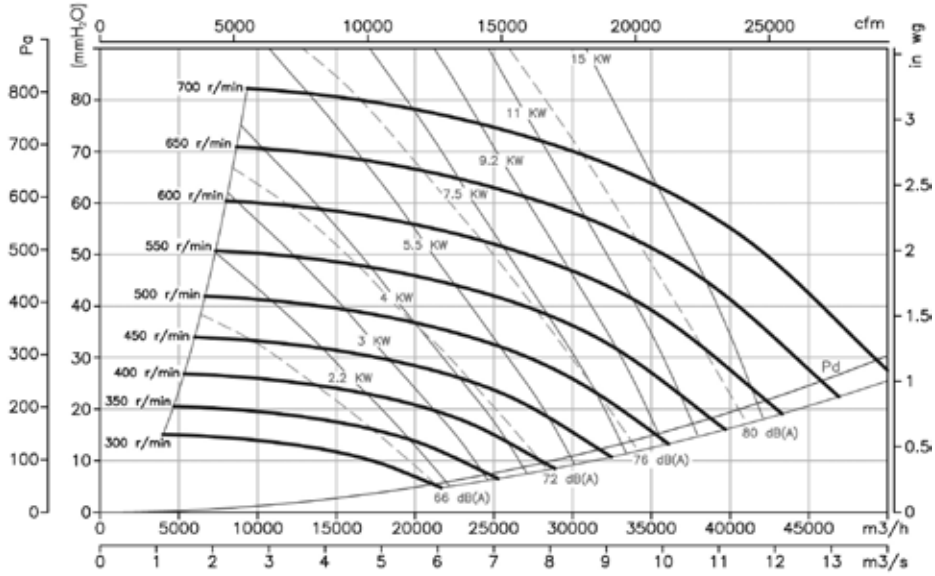

CJTX-C-30/28

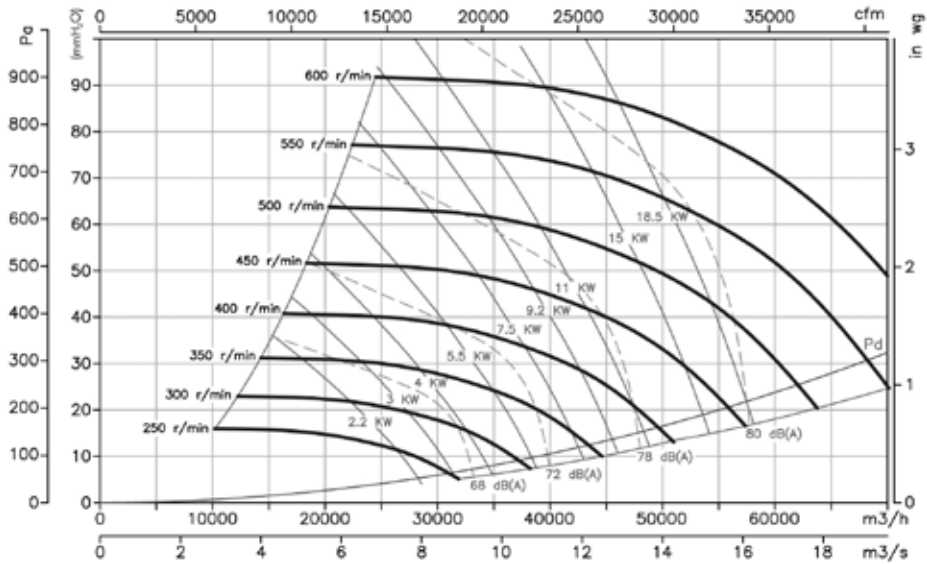

Accessories

See accessories section



CJSX



Motor outside the airflow path

400°C/2h belt-driven extraction units with single-inlet fan

400°C/2h extraction units with motor outside the airflow path to work outside fire danger zones.

Fan:

- Galvanized sheet steel structure.
- Impeller with forward-facing blades made from galvanised sheet steel
- Approval according to Standard EN-12101-3-2002, certificate no.: 0370-CPD-0503

Motor:

- Class F motors with ball bearings, IP55 protection
- Three-phase 230/400V.-50Hz. (up to 5.5CV.) and 400/690V.-50Hz. (power over 5.5CV.)
- Max. temperature of air for transport: S1 Service -20°C+ 120°C for ongoing use, S2 Service 200°C/2h, 300°C/2h and 400°C/2h

Finish:

- Anticorrosive galvanized sheet steel.

On request:

- Fans with two-speed motor.
- Fans with vertical outlet

Order code

CJSX — 22/11 — 3 — F-400

400°C/2h centrifugal fans with forward-facing impeller.

Impeller size

Power motor (c.v.)

F-400: Officially approved 400°C/2h

For Service S2: 200°C/2h, 300°C/2h and 400°C/2h

Technical characteristics

Model	Speed (r/min)	Maximum admissible current (A)			Power installed (kW)	Airflow maximum (m³/h)	Sound pressure level dB(A)	Approx. weight (Kg)
		230V	400V (A)	690V				
CJSX-12/6-0.75	1000	2.28	1.31		0.55	2600	69	73
CJSX-12/6-1	1100	3.10	1.79		0.75	3100	71	74
CJSX-12/6-1.5	1250	4.03	2.32		1.10	3500	74	77
CJSX-12/6-2	1300	5.96	3.44		1.50	4250	77	80
CJSX-12/6-3	1500	8.36	4.83		2.20	4800	79	85
CJSX-15/7-1	800	3.10	1.79		0.75	4000	67	92
CJSX-15/7-1.5	850	4.03	2.32		1.10	4800	69	95
CJSX-15/7-2	920	5.96	3.44		1.50	5400	72	98
CJSX-15/7-3	1000	8.36	4.83		2.20	6400	75	103
CJSX-15/7-4	1050	10.96	6.33		3.00	7400	77	106
CJSX-18/9-1.5	750	4.03	2.32		1.10	5800	68	111
CJSX-18/9-2	790	5.96	3.44		1.50	6600	70	114
CJSX-18/9-3	800	8.36	4.83		2.20	8200	74	119
CJSX-18/9-4	850	10.96	6.33		3.00	9000	76	122
CJSX-18/9-5.5	920	14.10	8.12		4.00	10500	78	125
CJSX-20/10-2	650	5.96	3.44		1.50	8100	65	203
CJSX-20/10-3	690	8.36	4.83		2.20	10100	68	208
CJSX-20/10-4	750	10.96	6.33		3.00	11500	70	211
CJSX-20/10-5.5	790	14.10	8.12		4.00	13100	73	214

Technical characteristics

Model	Speed (r/min)	Maximum admissible current (A)			Power installed (kW)	Airflow maximum (m³/h)	Sound pressure level dB(A)	Approx. weight (Kg)
		230V	400V (A)	690V				
CJSX-20/10-7.5	850		11.60	6.72	5.50	15000	75	227
CJSX-22/11-3	580	8.36	4.83		2.20	11200	67	219
CJSX-22/11-4	610	10.96	6.33		3.00	13000	70	222
CJSX-22/11-5.5	650	14.10	8.12		4.00	15000	72	225
CJSX-22/11-7.5	690		11.60	6.72	5.50	17000	74	238
CJSX-22/11-10	750		14.20	8.20	7.50	19000	76	246
CJSX-22/11-15	830		20.20	11.60	11.00	22000	79	273
CJSX-22/11-20	910		27.50	15.90	15.00	24500	81	292
CJSX-22/11-25	1000		35.00	20.00	18.50	26000	83	322
CJSX-25/13-4	520	10.96	6.33		3.00	14000	62	254
CJSX-25/13-5.5	550	14.10	8.12		4.00	17000	65	257
CJSX-25/13-7.5	590		11.60	6.72	5.50	19500	67	270
CJSX-25/13-10	620		14.20	8.20	7.50	23000	70	278
CJSX-25/13-15	690		20.20	11.60	11.00	26500	74	305
CJSX-25/13-20	750		27.50	15.90	15.00	29500	75	324
CJSX-25/13-25	810		35.00	20.00	18.50	32000	77	354
CJSX-30/14-5.5	400	14.10	8.12		4.00	21000	69	331
CJSX-30/14-7.5	425		11.60	6.72	5.50	24000	72	344
CJSX-30/14-10	460		14.20	8.20	7.50	27500	74	352
CJSX-30/14-15	500		20.20	11.60	11.00	33000	77	379
CJSX-30/14-20	550		27.50	15.90	15.00	36500	78	398
CJSX-30/14-25	600		35.00	20.00	18.50	38000	81	428



Erp. BEP (best efficiency point) characteristics

MC	Measurement category	ne[%]	Efficiency
EC	Efficiency category	N	Efficiency grade
S	Static	[kW]	Input power
T	Total	[m³/h]	Airflow
VSD	Variable-speed drive	[mmH₂O]	Static or total pressure (According to EC)
SR	Specific ratio	[RPM]	Speed

Model	MC	EC	VSD	SR	ne[%]	N	(kW)	(m³/h)	(mmH ₂ O)	(RPM)
CJSX-12/6-0.75	C	S	NO	1.00	36.0%	44.7	0.423	1532	36.46	1000
CJSX-12/6-1	C	S	NO	1.00	40.4%	48.6	0.502	1685	44.12	1100
CJSX-12/6-1.5	C	S	NO	1.01	41.6%	48.9	0.715	1915	56.97	1250
CJSX-12/6-2	C	S	NO	1.01	42.0%	49.0	0.796	1992	61.62	1300
CJSX-12/6-3	C	S	NO	1.01	42.8%	48.6	1.201	2298	82.04	1500
CJSX-15/7-1	C	S	NO	1.00	45.9%	54.7	0.403	2011	33.76	800
CJSX-15/7-1.5	C	S	NO	1.00	47.3%	55.7	0.469	2137	38.11	850
CJSX-15/7-2	C	S	NO	1.00	47.8%	55.5	0.589	2313	44.64	920
CJSX-15/7-3	C	S	NO	1.01	48.6%	55.8	0.743	2514	52.74	1000
CJSX-15/7-4	C	S	NO	1.01	49.3%	56.1	0.848	2639	58.15	1050
CJSX-18/9-1.5	C	S	NO	1.00	56.0%	63.6	0.622	2983	42.82	750
CJSX-18/9-2	C	S	NO	1.00	56.5%	63.8	0.720	3143	47.51	790
CJSX-18/9-3	C	S	NO	1.00	57.6%	64.7	0.734	3182	48.72	800
CJSX-18/9-4	C	S	NO	1.01	58.4%	65.1	0.868	3381	55.00	850
CJSX-18/9-5.5	C	S	NO	1.01	59.4%	65.5	1.082	3660	64.44	920
CJSX-20/10-2	C	S	NO	1.00	58.5%	66.0	0.647	3584	38.75	650
CJSX-20/10-3	C	S	NO	1.00	59.5%	66.6	0.761	3804	43.67	690
CJSX-20/10-4	C	S	NO	1.01	60.4%	66.8	0.963	4135	51.59	750
CJSX-20/10-5.5	C	S	NO	1.01	61.4%	67.5	1.106	4356	57.24	790
CJSX-20/10-7.5	C	S	NO	1.01	62.2%	67.7	1.360	4686	66.27	850
CJSX-22/11-3	C	S	NO	1.00	49.8%	55.0	1.471	6976	38.50	580
CJSX-22/11-4	C	S	NO	1.00	50.6%	55.5	1.684	7337	42.59	610
CJSX-22/11-5.5	C	S	NO	1.01	51.6%	56.1	1.996	7818	48.36	650
CJSX-22/11-7.5	C	S	NO	1.01	52.4%	56.4	2.352	8299	54.49	690
CJSX-22/11-10	C	S	NO	1.01	53.1%	56.5	2.980	9021	64.38	750
CJSX-22/11-15	C	S	NO	1.01	54.3%	56.8	3.952	9983	78.85	830
CJSX-22/11-20	C	S	NO	1.01	55.4%	57.2	5.105	10946	94.78	910
CJSX-22/11-25	C	S	NO	1.01	55.3%	56.4	6.785	12028	114.46	1000
CJSX-25/13-4	C	S	NO	1.00	47.2%	52.3	1.546	6778	39.51	520
CJSX-25/13-5.5	C	S	NO	1.00	48.2%	52.9	1.793	7169	44.20	550
CJSX-25/13-7.5	C	S	NO	1.01	48.9%	53.1	2.181	7691	50.87	590
CJSX-25/13-10	C	S	NO	1.01	49.4%	53.2	2.503	8082	56.17	620
CJSX-25/13-15	C	S	NO	1.01	50.5%	53.5	3.379	8994	69.57	690



Erp. BEP (best efficiency point) characteristics

Model	MC	EC	VSD	SR	η_e [%]	N	(kW)	(m ³ /h)	(mmH ₂ O)	(RPM)
CJSX-25/13-20	C	S	NO	1.01	51.3%	53.7	4.264	9776	82.20	750
CJSX-25/13-25	C	S	NO	1.01	51.5%	53.3	5.354	10558	95.87	810
CJSX-30/14-5.5	C	S	NO	1.00	50.3%	54.5	2.235	11535	35.79	400
CJSX-30/14-7.5	C	S	NO	1.00	51.1%	54.8	2.640	12256	40.40	425
CJSX-30/14-10	C	S	NO	1.01	51.8%	54.9	3.300	13265	47.33	460
CJSX-30/14-15	C	S	NO	1.01	52.9%	55.3	4.152	14419	55.91	500
CJSX-30/14-20	C	S	NO	1.01	54.0%	55.7	5.410	15861	67.66	550
CJSX-30/14-25	C	S	NO	1.01	53.8%	54.8	7.056	17303	80.52	600

Dimensions in mm

Standard supply horizontal outlet (H) RD-90

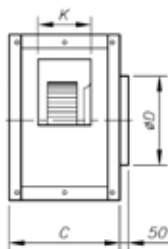
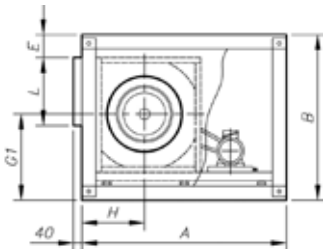

Supply on demand vertical outlet (V) RD-0

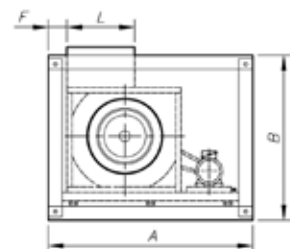
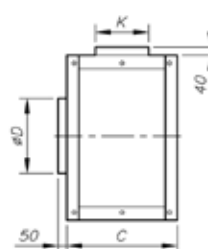

Supply on demand horizontal outlet (H) LG-90

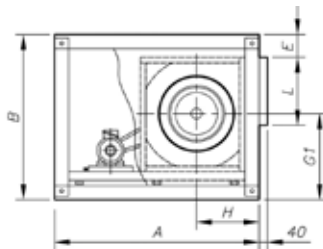
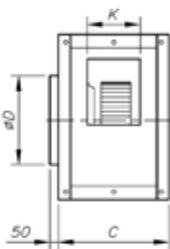

Supply on demand vertical outlet (V) LG-0

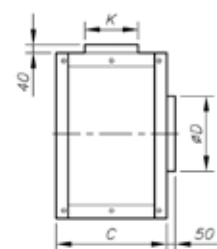
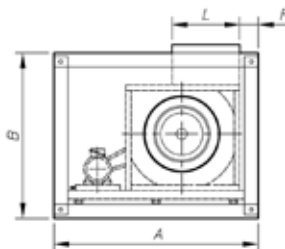

Modelo	A	B	C	ØD	E	com bank E	F	G1	com bank G1	H	L	com bank L	K
CJSX-12/6-H	850	650	540	330	74	-	-	288	-	288	346	-	210
CJSX-12/6-V	850	650	540	330	-	-	30	318	-	328	346	-	210
CJSX-15/7-H	1000	755	600	400	74	-	-	328	-	328	411	-	270
CJSX-15/7-V	1000	755	600	400	-	-	30	378	-	383	411	-	270
CJSX-18/9-H	1200	875	620	480	74	-	-	383	-	388	491	-	305
CJSX-18/9-V	1200	875	620	480	-	-	30	433	-	448	491	-	305
CJSX-20/10-H	1485	1175	730	565	175	120	-	475	530	440	613	605	343
CJSX-20/10-V	1485	1175	730	565	-	-	75	535	-	585	613	-	343
CJSX-22/11-H	1570	1250	760	615	165	110	-	510	565	470	708	700	373
CJSX-22/11-V	1570	1250	760	615	-	-	75	570	-	640	708	-	373
CJSX-25/13-H	1610	1375	820	685	175	120	-	550	605	495	803	795	423
CJSX-25/13-V	1610	1375	820	685	-	-	75	625	-	705	803	-	423
CJSX-30/14-H	1845	1600	855	820	160	95	-	655	710	580	943	935	488
CJSX-30/14-V	1845	1600	855	820	-	-	75	760	-	825	943	-	488

Characteristic curves

Q = Airflow in m³/h, m³/s and cfm.

Pe = Static pressure in mm.w.c., Pa and inwg.

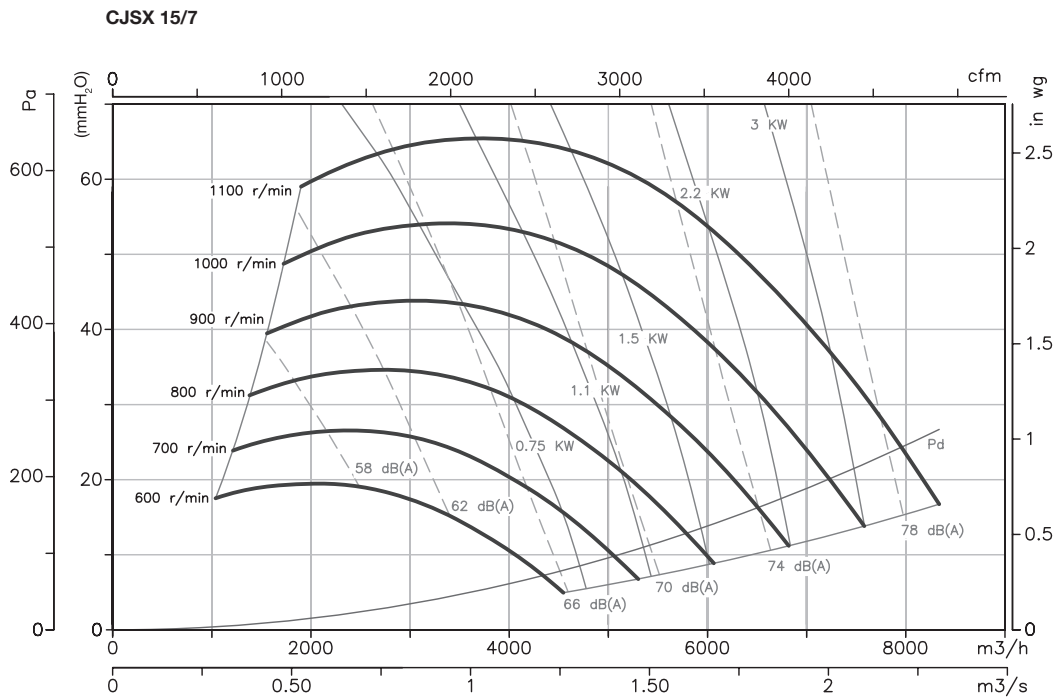
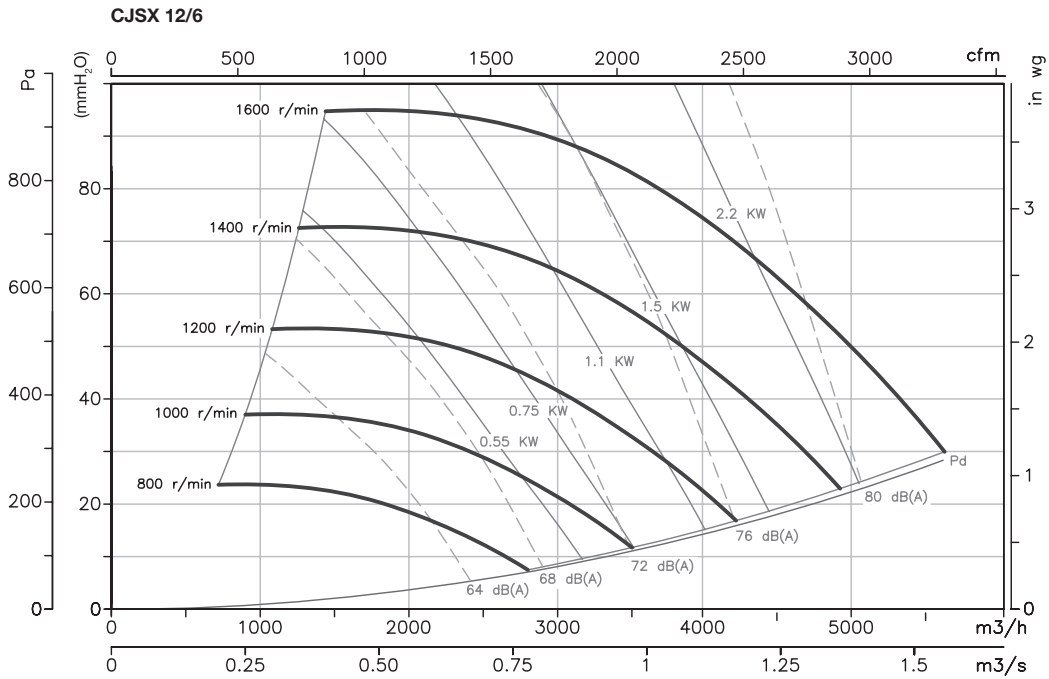

Characteristic curves

Q = Airflow in m³/h, m³/s and cfm.

Pe = Static pressure in mm.w.c., Pa and inwg.

CJSX 18/9

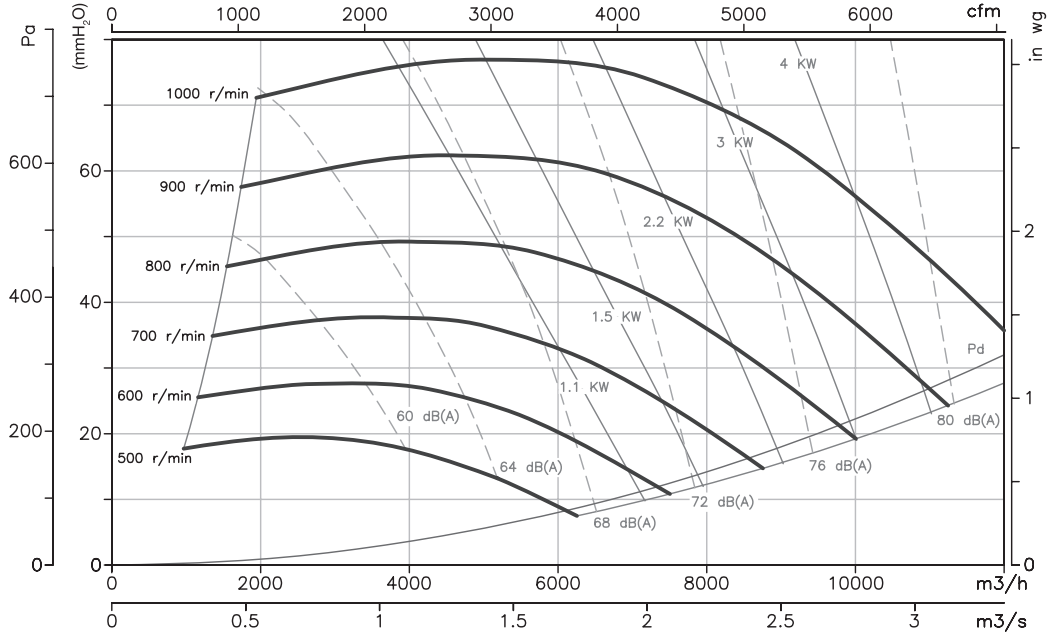

CJSX 20/10

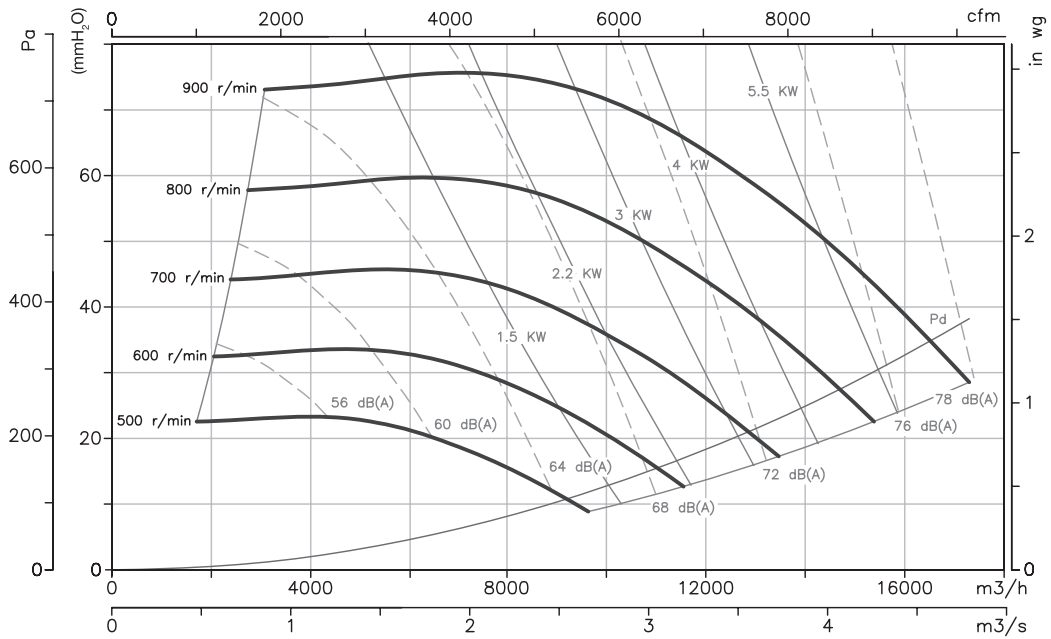

Characteristic curves

Q = Airflow in m³/h, m³/s and cfm.

Pe= Static pressure in mm.w.c., Pa and inwg.

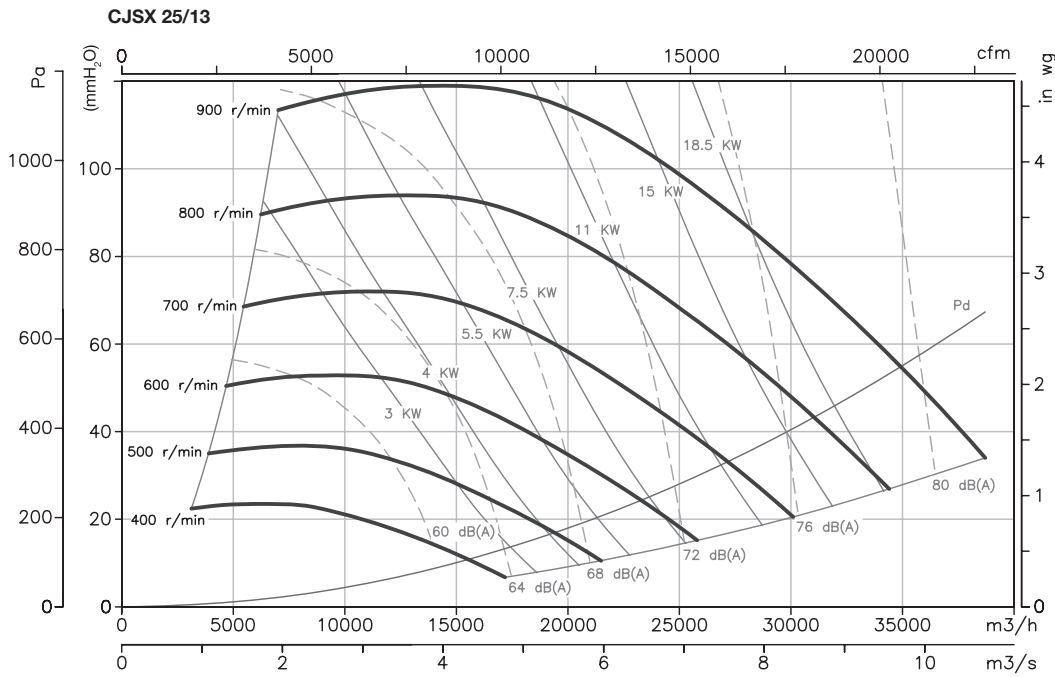
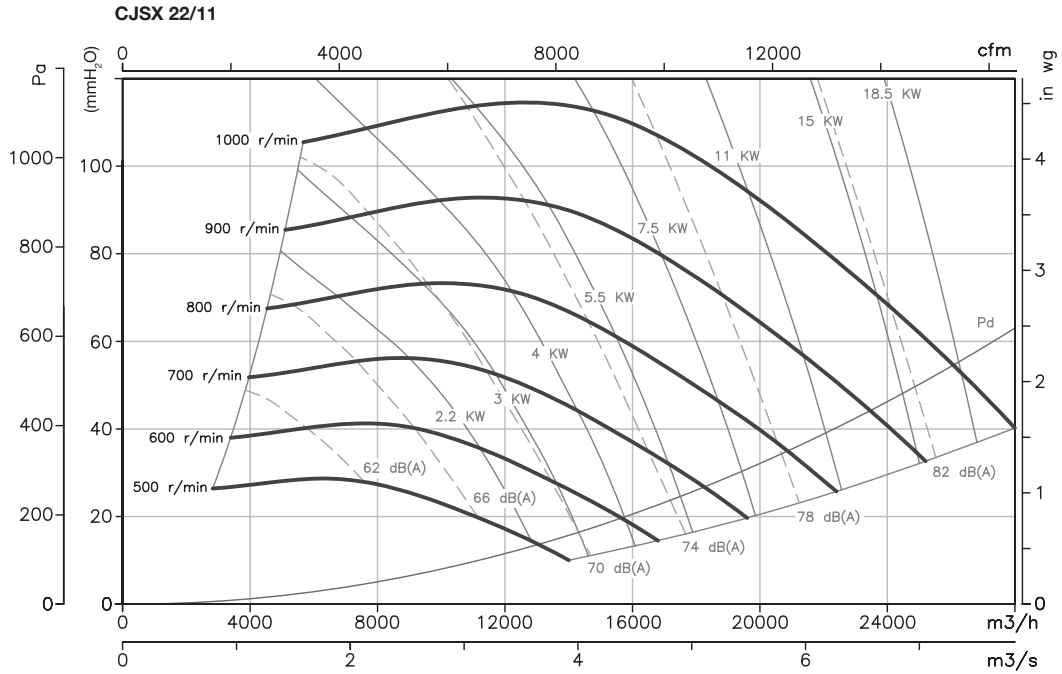

Characteristic curves

Q = Airflow in m³/h, m³/s and cfm.

Pe= Static pressure in mm.w.c., Pa and inwg.

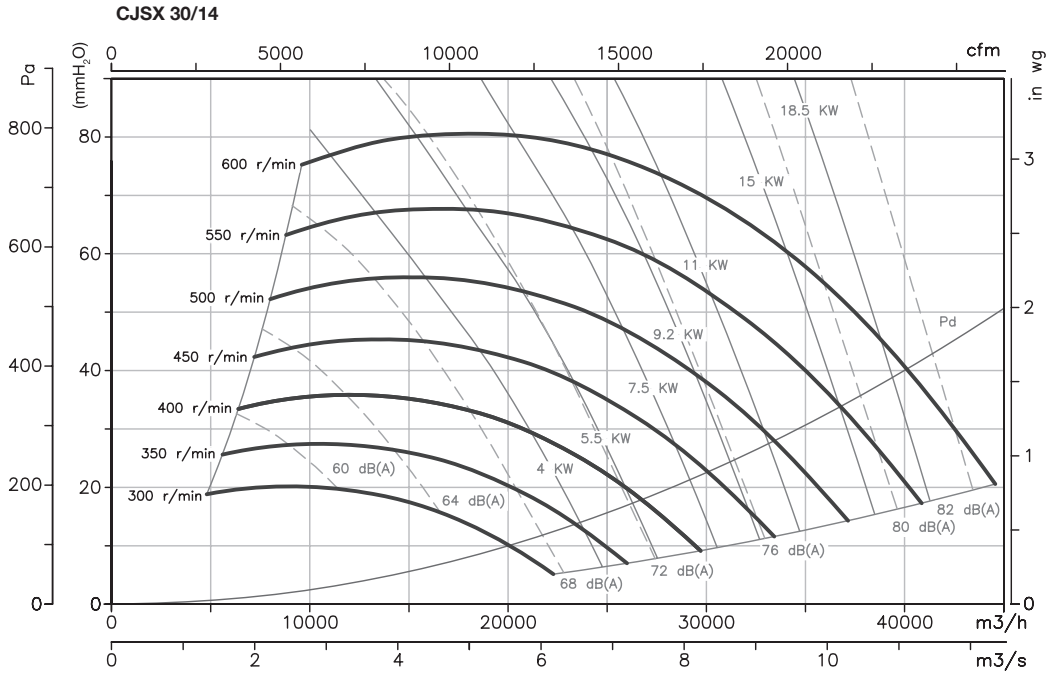

Accessories

See accessories section



CSX



High-performance and robust backward-curved impeller.

400°C/2h centrifugal belt-driven fans to work outside fire danger zones with backward-curved impeller

400°C/2h centrifugal belt-driven fans with backward-curved impeller with electric motor, pulley, belt kit and standardised protectors accordance with standard EN-294 and ISO-13852

Fan:

- Steel sheet casing
- Impeller with backward-curved blades made from sheet steel
- Approval according to Standard EN-12101-3:2002, certificate no.: 0370-CPD-1577
- Pulley and belt kit and standardised protectors in accordance with standard EN-294 and ISO-13852

Motor:

- Motors with IE-2 efficiency, except for motors with lower powers than 0.75 kW and single-phase motors.
- Class F motors, with bearings, IP55 protection.
- Three-phase 230/400V.-50Hz. (up to 5.5CV) and 400/690V.-50Hz. (power over 5.5CV)
- Max. air temperature to transport: -20°C.+ 150°C.

Finish:

- Anticorrosive finish in polyester resin, polymerised at 190°C, after alkaline degreasing and phosphate-free pre-treatment.

On request:

- Special windings for different voltages



Order code



CSX: 400°C/2h centrifugal belt-driven fans to work outside fire danger zones

Impeller size

Motor power (c.v.)

F-400: Officially approved 400°C/2h

Technical characteristics

Model	Speed (r/min)	Maximum admissible current (A)			Installed power (kW)	Maximum airflow (m³/h)	Approx. weight (Kg)
		230V	400V (A)	690V			
CSX-315-0.5	1650	1.84	1.06		0.37	2700	30
CSX-315-0.75	1880	2.57	1.49		0.55	3075	32
CSX-315-1	2095	2.78	1.60		0.75	3430	34
CSX-315-1.5	2375	4.20	2.40		1.10	3885	36
CSX-315-2	2655	5.44	3.13		1.50	4345	39
CSX-315-3	3000	7.77	4.47		2.20	4910	42
CSX-315-4	3380	10.18	5.88		3.00	5530	47
CSX-355-0.5	1385	1.84	1.06		0.37	3235	39
CSX-355-0.75	1580	2.57	1.49		0.55	3685	41
CSX-355-1	1765	2.78	1.60		0.75	4120	44
CSX-355-1.5	2010	4.20	2.40		1.10	4690	46
CSX-355-2	2225	5.44	3.13		1.50	5190	48
CSX-355-3	2530	7.77	4.47		2.20	5905	53
CSX-355-4	2860	10.18	5.88		3.00	6675	57
CSX-355-5.5	3100	13.60	7.82		4.00	7235	63
CSX-400-0.75	1320	2.28	1.31		0.55	4375	49
CSX-400-1	1465	3.10	1.79		0.75	4855	52
CSX-400-1.5	1665	4.03	2.32		1.10	5515	54
CSX-400-2	1845	5.96	3.44		1.50	6110	56
CSX-400-3	2100	8.36	4.83		2.20	6955	59
CSX-400-4	2370	10.18	5.88		3.00	7850	64
CSX-400-5.5	2610	13.60	7.82		4.00	8645	72

Technical characteristics

Model	Speed (r/min)	Maximum admissible current (A)			Installed power (kW)	Maximum airflow (m³/h)	Approx. weight (Kg)
		230V	400V (A)	690V			
CSX-450-0.75	1095	2.28	1.31		0.55	5045	61
CSX-450-1	1220	3.10	1.79		0.75	5620	64
CSX-450-1.5	1390	4.03	2.32		1.10	6405	66
CSX-450-2	1540	5.96	3.44		1.50	7095	68
CSX-450-3	1750	8.36	4.83		2.20	8065	72
CSX-450-4	1980	10.18	5.88		3.00	9120	76
CSX-450-5.5	2180	13.60	7.82		4.00	10045	85
CSX-450-7.5	2420		10.50	6.09	5.50	11150	95
CSX-450-10	2670		14.50	8.41	7.50	12300	100
CSX-500-1	1005	3.10	1.79		0.75	6465	86
CSX-500-1.5	1140	4.03	2.32		1.10	7330	88
CSX-500-2	1270	5.96	3.44		1.50	8165	90
CSX-500-3	1445	8.36	4.83		2.20	9290	93
CSX-500-4	1635	10.96	6.33		3.00	10510	98
CSX-500-5.5	1800	14.10	8.12		4.00	11570	107
CSX-500-7.5	2000		10.50	6.09	5.50	12855	116
CSX-500-10	2220		14.50	8.41	7.50	14270	121
CSX-500-15	2300		20.20	11.60	11.00	14785	155
CSX-560-2	1035	5.96	3.44		1.50	9885	100
CSX-560-3	1185	8.36	4.83		2.20	11360	103
CSX-560-4	1340	10.96	6.33		3.00	12880	108
CSX-560-5.5	1475	14.10	8.12		4.00	14210	117
CSX-560-7.5	1640		11.60	6.72	5.50	15830	122
CSX-560-10	1815		14.50	8.41	7.50	17555	132
CSX-560-15	2065		20.20	11.60	11.00	20010	166
CSX-630-3	1010	8.36	4.83		2.20	12120	119
CSX-630-4	1140	10.96	6.33		3.00	13680	123
CSX-630-5.5	1255	14.10	8.12		4.00	15060	132
CSX-630-7.5	1395		11.60	6.72	5.50	16740	138
CSX-630-10	1550		14.50	8.41	7.50	18600	147
CSX-630-15	1760		20.20	11.60	11.00	21120	181
CSX-630-20	1900		27.50	15.90	15.00	22800	202
CSX-710-4	960	10.96	6.33		3.00	17065	186
CSX-710-5.5	1060	14.10	8.12		4.00	18845	195
CSX-710-7.5	1180		11.60	6.72	5.50	20980	200
CSX-710-10	1305		14.20	8.20	7.50	23200	210
CSX-710-15	1485		20.20	11.60	11.00	26400	244
CSX-710-20	1670		27.50	15.90	15.00	29690	265
CSX-710-25	1750		35.00	20.00	18.50	31110	285
CSX-800-4	765	10.96	6.33		3.00	19975	226
CSX-800-5.5	845	14.10	8.12		4.00	22065	234
CSX-800-7.5	940		11.60	6.72	5.50	24545	240
CSX-800-10	1040		14.50	8.41	7.50	27155	250
CSX-800-15	1185		20.20	11.60	11.00	30940	284
CSX-800-20	1330		27.50	15.90	15.00	34730	305
CSX-800-25	1420		35.00	20.00	18.50	37080	325
CSX-900-4	640	10.96	6.33		3.00	21200	281
CSX-900-5.5	705	14.10	8.12		4.00	23355	289
CSX-900-7.5	785		11.60	6.72	5.50	26005	295
CSX-900-10	870		14.50	8.41	7.50	28820	305
CSX-900-15	990		20.20	11.60	11.00	32795	339
CSX-900-20	1100		27.50	15.90	15.00	36440	360
CSX-900-25	1150		35.00	20.00	18.50	38095	380
CSX-900-30	1200		42.00	24.00	22.00	39750	399
CSX-1000-5.5	575	14.10	8.12		4.00	25555	342
CSX-1000-7.5	645		11.60	6.72	5.50	28665	348
CSX-1000-10	715		14.50	8.41	7.50	31780	358
CSX-1000-15	815		20.20	11.60	11.00	36220	392
CSX-1000-20	915		27.50	15.90	15.00	40665	413
CSX-1000-25	980		35.00	20.00	18.50	43555	432
CSX-1000-30	1040		42.00	24.00	22.00	46220	452
CSX-1000-40	1120		55.00	32.00	30.00	49780	506



Erp. BEP (best efficiency point) characteristics

MC	Measurement category	ηe[%]	Efficiency
EC	Efficiency category	N	Efficiency grade
S	Static	[kW]	Input power
T	Total	[m³/h]	Airflow
VSD	Variable-speed drive	[mmH₂O]	Static or total pressure (According to EC)
SR	Specific ratio	[RPM]	Speed

Model	MC	EC	VSD	SR	ηe[%]	N	(kW)	(m³/h)	(mmH ₂ O)	(RPM)
315-0.5	C	S	NO	1.00	42.7%	57.1	0.423	1503	44.14	1650
315-0.75	C	S	NO	1.01	44.6%	57.4	0.599	1712	57.30	1880
315-1	C	S	NO	1.01	49.0%	60.8	0.755	1908	71.16	2095
315-1.5	C	S	NO	1.01	50.0%	60.2	1.078	2163	91.45	2375
315-2	C	S	NO	1.01	51.0%	59.7	1.478	2418	114.29	2655
315-3	C	S	NO	1.01	53.1%	60.4	2.045	2732	145.92	3000
315-4	C	S	NO	1.02	53.9%	59.6	2.883	3078	185.22	3380
355-0.5	C	S	NO	1.00	51.3%	66.4	0.367	1700	40.59	1385
355-0.75	C	S	NO	1.01	53.6%	67.0	0.521	1940	52.82	1580
355-1	C	S	NO	1.01	58.8%	71.2	0.661	2167	65.91	1765
355-1.5	C	S	NO	1.01	60.1%	70.8	0.957	2467	85.48	2010
355-2	C	S	NO	1.01	61.1%	70.5	1.276	2731	104.75	2225
355-3	C	S	NO	1.01	63.7%	71.5	1.800	3106	135.43	2530
355-4	C	S	NO	1.02	64.5%	70.8	2.565	3511	173.07	2860
355-5.5	C	S	NO	1.02	66.0%	71.2	3.194	3805	203.33	3100
400-0.75	C	S	NO	1.00	49.0%	62.0	0.578	2362	44.01	1320
400-1	C	S	NO	1.01	52.7%	64.6	0.735	2622	54.21	1465
400-1.5	C	S	NO	1.01	54.3%	64.6	1.047	2979	70.02	1665
400-2	C	S	NO	1.01	54.9%	63.8	1.409	3302	85.98	1845
400-3	C	S	NO	1.01	56.2%	63.5	2.030	3758	111.39	2100
400-4	C	S	NO	1.01	56.8%	62.5	2.886	4241	141.88	2370
400-5.5	C	S	NO	1.02	58.2%	62.7	3.761	4670	172.06	2610
450-0.75	C	S	NO	1.00	48.1%	60.9	0.599	2807	37.69	1095
450-1	C	S	NO	1.00	51.7%	63.4	0.771	3127	46.79	1220
450-1.5	C	S	NO	1.01	53.3%	63.3	1.106	3563	60.73	1390
450-2	C	S	NO	1.01	53.9%	62.6	1.487	3947	74.55	1540
450-3	C	S	NO	1.01	55.2%	62.3	2.132	4485	96.27	1750
450-4	C	S	NO	1.01	55.8%	61.3	3.052	5075	123.23	1980
450-5.5	C	S	NO	1.01	57.3%	61.5	3.972	5588	149.39	2180
450-7.5	C	S	NO	1.02	58.7%	61.5	5.305	6203	184.09	2420
450-10	C	S	NO	1.02	59.6%	61.3	7.008	6843	224.09	2670
500-1	C	S	NO	1.00	53.2%	65.0	0.753	3608	40.71	1005
500-1.5	C	S	NO	1.01	54.8%	65.0	1.067	4093	52.38	1140
500-2	C	S	NO	1.01	55.4%	64.2	1.458	4560	65.01	1270
500-3	C	S	NO	1.01	56.7%	63.8	2.098	5188	84.16	1445
500-4	C	S	NO	1.01	58.0%	63.5	2.973	5870	107.74	1635
500-5.5	C	S	NO	1.01	59.5%	63.8	3.866	6463	130.58	1800
500-7.5	C	S	NO	1.02	60.2%	63.2	5.237	7181	161.22	2000
500-10	C	S	NO	1.02	61.3%	62.9	7.041	7971	198.63	2220
500-15	C	S	NO	1.02	62.5%	63.7	7.672	8258	213.21	2300
560-2	C	S	NO	1.01	54.9%	63.6	1.485	5921	50.50	1035
560-3	C	S	NO	1.01	56.2%	63.2	2.175	6780	66.20	1185
560-4	C	S	NO	1.01	57.5%	62.9	3.076	7666	84.65	1340
560-5.5	C	S	NO	1.01	59.0%	63.2	3.997	8439	102.57	1475
560-7.5	C	S	NO	1.01	60.5%	63.3	5.362	9383	126.80	1640
560-10	C	S	NO	1.02	60.7%	62.2	7.239	10384	155.30	1815
560-15	C	S	NO	1.02	61.9%	62.0	10.447	11814	201.03	2065
630-3	C	S	NO	1.01	58.6%	65.4	2.257	7231	67.17	1010
630-4	C	S	NO	1.01	60.0%	65.2	3.173	8162	85.58	1140
630-5.5	C	S	NO	1.01	61.6%	65.6	4.123	8985	103.71	1255
630-7.5	C	S	NO	1.01	63.1%	65.8	5.524	9987	128.14	1395
630-10	C	S	NO	1.02	63.3%	64.6	7.559	11097	158.20	1550
630-15	C	S	NO	1.02	64.6%	64.6	10.844	12600	203.97	1760
630-20	C	S	NO	1.02	65.2%	64.9	13.523	13603	237.71	1900
710-4	C	S	NO	1.01	64.9%	69.8	3.357	12025	66.44	960
710-5.5	C	S	NO	1.01	66.7%	70.4	4.397	13277	81.00	1060
710-7.5	C	S	NO	1.01	68.3%	70.7	5.917	14781	100.38	1180
710-10	C	S	NO	1.01	68.9%	69.9	7.941	16346	122.77	1305
710-15	C	S	NO	1.02	69.7%	69.6	11.557	18601	158.97	1485
710-20	C	S	NO	1.02	70.3%	69.9	16.292	20918	201.05	1670
710-25	C	S	NO	1.02	69.9%	69.2	18.872	21920	220.78	1750
800-4	C	S	NO	1.01	59.0%	64.4	3.084	11226	59.47	765



Erp. BEP (best efficiency point) characteristics

MC	Measurement category	ηe[%]	Efficiency
EC	Efficiency category	N	Efficiency grade
S	Static	[kW]	Input power
T	Total	[m³/h]	Airflow
VSD	Variable-speed drive	[mmH₂O]	Static or total pressure (According to EC)
SR	Specific ratio	[RPM]	Speed

Model	MC	EC	VSD	SR	ηe[%]	N	(kW)	(m³/h)	(mmH₂O)	(RPM)
800-5.5	C	S	NO	1.01	60.6%	64.7	4.048	12400	72.56	845
800-7.5	C	S	NO	1.01	62.1%	64.9	5.437	13794	89.79	940
800-10	C	S	NO	1.01	62.3%	63.7	7.338	15262	109.91	1040
800-15	C	S	NO	1.01	63.6%	63.6	10.638	17390	142.69	1185
800-20	C	S	NO	1.02	64.1%	63.8	14.907	19517	179.75	1330
800-25	C	S	NO	1.02	63.7%	63.1	18.264	20838	204.90	1420
900-4	C	S	NO	1.01	58.4%	63.7	3.123	12272	54.55	640
900-5.5	C	S	NO	1.01	60.0%	64.1	4.067	13518	66.19	705
900-7.5	C	S	NO	1.01	61.5%	64.2	5.476	15052	82.07	785
900-10	C	S	NO	1.01	61.7%	63.0	7.433	16682	100.80	870
900-15	C	S	NO	1.01	62.9%	62.9	10.733	18983	130.53	990
900-20	C	S	NO	1.02	63.5%	63.1	14.592	21092	161.15	1100
900-25	C	S	NO	1.02	63.1%	62.6	16.785	22051	176.13	1150
900-30	C	S	NO	1.02	63.4%	62.8	18.966	23010	191.78	1200
1000-5.5	C	S	NO	1.01	61.0%	65.3	3.883	16465	52.78	575
1000-7.5	C	S	NO	1.01	62.5%	65.4	5.344	18470	66.41	645
1000-10	C	S	NO	1.01	62.8%	64.3	7.250	20474	81.61	715
1000-15	C	S	NO	1.01	64.1%	64.1	10.521	23338	106.04	815
1000-20	C	S	NO	1.01	64.7%	64.3	14.757	26201	133.65	915
1000-25	C	S	NO	1.02	64.2%	63.6	18.252	28063	153.32	980
1000-30	C	S	NO	1.02	64.6%	63.8	21.693	29781	172.66	1040
1000-40	C	S	NO	1.02	65.3%	64.3	26.798	32072	200.25	1120

Dimensions in mm

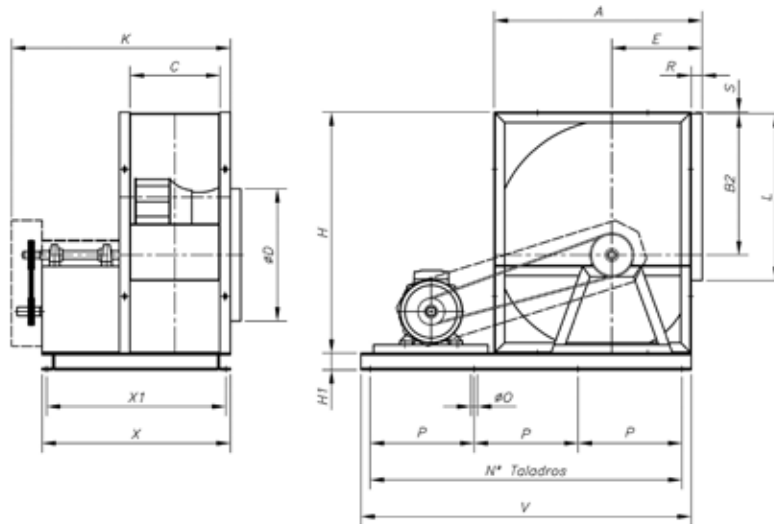

	A	B	C	L	K2	K1	J2	J1	N	øD	H	E	F	K	X	ø0	P	V	x1	x2	x
CSX -315	522	771.5	223	404	253	126.5	434	-	13x9	313	400	236	139.5	769	679	12	454	504	315	264	415
CSX -355	582.5	869.5	247	453	277	138.5	483	-	13x9	353	450	261	158	793	703	12	496	546	315	288	415
CSX -400	651	963	274	507	304	152	537	-	13x9	398	500	290	179.5	820	730	12	542	592	315	315	415
CSX -450	727.5	1067	308	569	338	169	599	-	13x9	448	550	322	202.5	959	829	12	595	645	380	349	480
CSX -500	801	1180	344	638	374	187	658	-	13x9	498	600	352	221	1005	875	12	654	704	380	380	480
CSX -560	892.5	1295	383	715	413	206.5	745	-	13x9	558	650	390	247.5	1202	1064	12	715	765	515	424	630
CSX -630	998.5	1489.5	432	801	462	231	831	-	13x9	628	769	434	280	1251	1113	12	780	830	515	473	630
CSX -710	1117	1547	479	902	508	254	928	200	13x9	708	730	481.5	316	1298	1160	14	890	930	515	520	630
CSX -800	1250	1665.5	533	1010	563	283.5	1037	250	13x9	798	762	535	358.5	1362	1219	14	980	1050	515	574.5	630
CSX -900	1408	1825	595	1130	625	312.5	1160	300	13x9	898	850	604	407	1424	1281	14	1080	1150	515	636.5	630
CSX -1000	1546	2016	663	1260	693	346.5	1297	350	13x9	998	900	651	433	1600	1456	14	1180	1250	642	690	742

Characteristic curves

Q = Airflow in m³/h, m³/s and cfm.

Pe= Static pressure in mm.w.c., Pa and inwg.

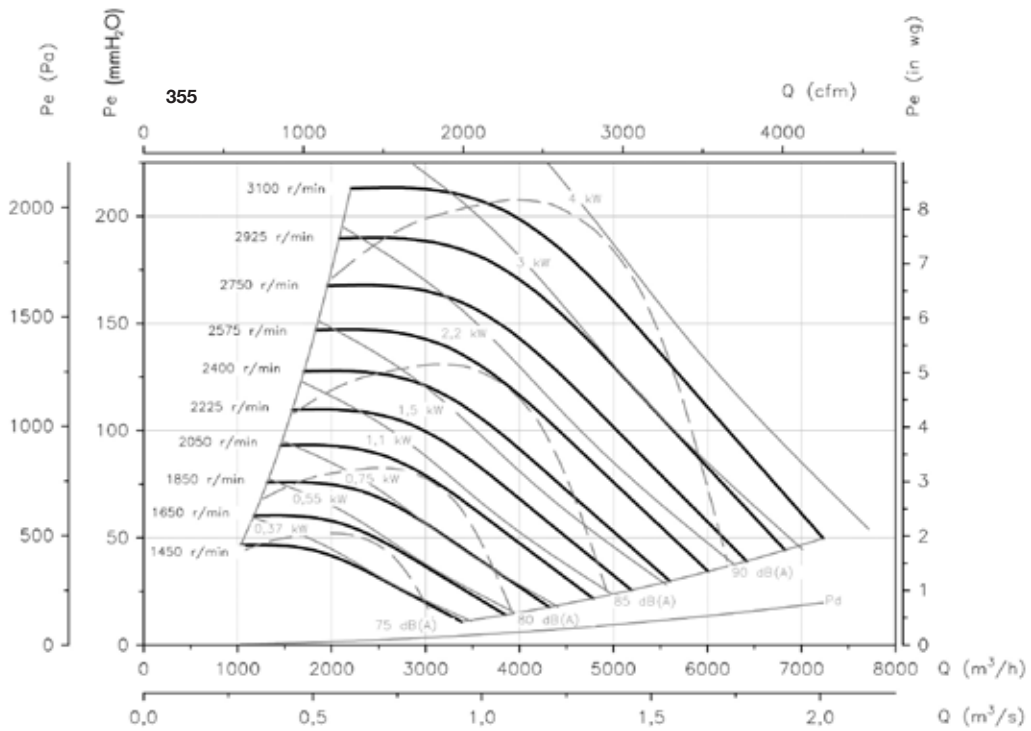
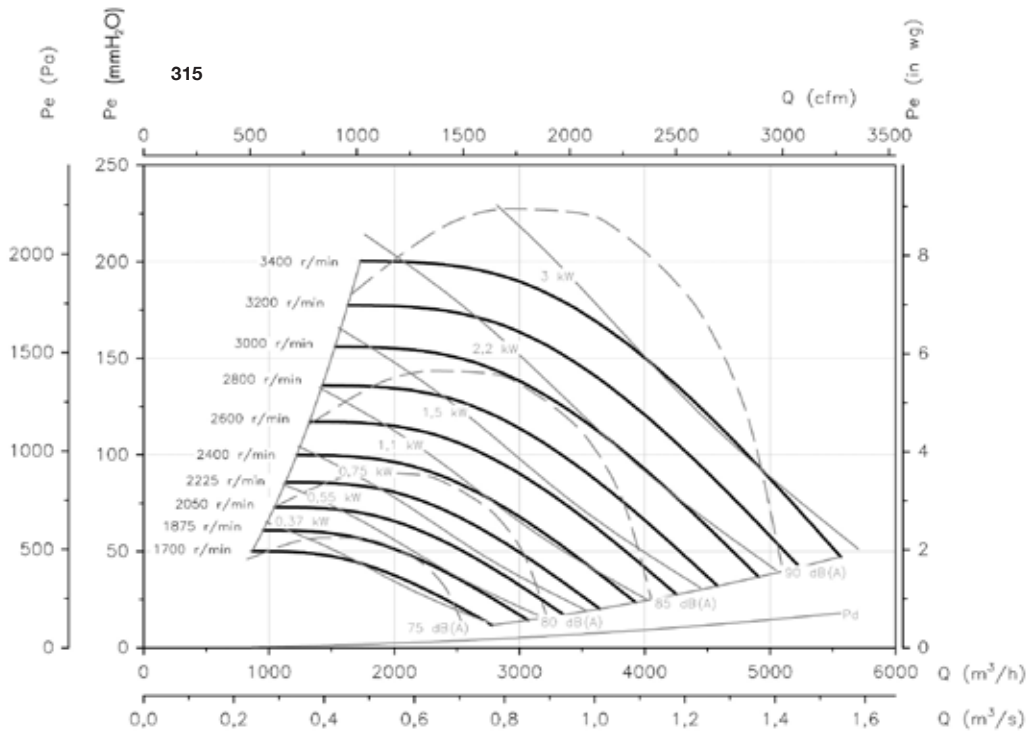

Characteristic curves

Q = Airflow in m³/h, m³/s and cfm.

Pe = Static pressure in mm.w.c., Pa and inwg.

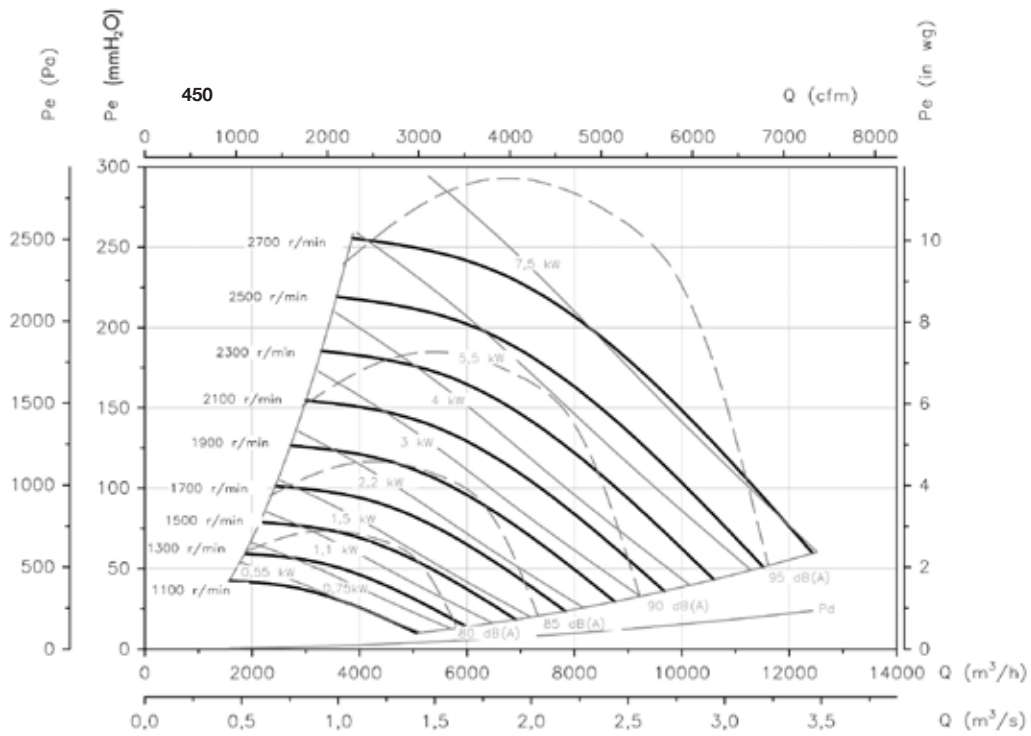
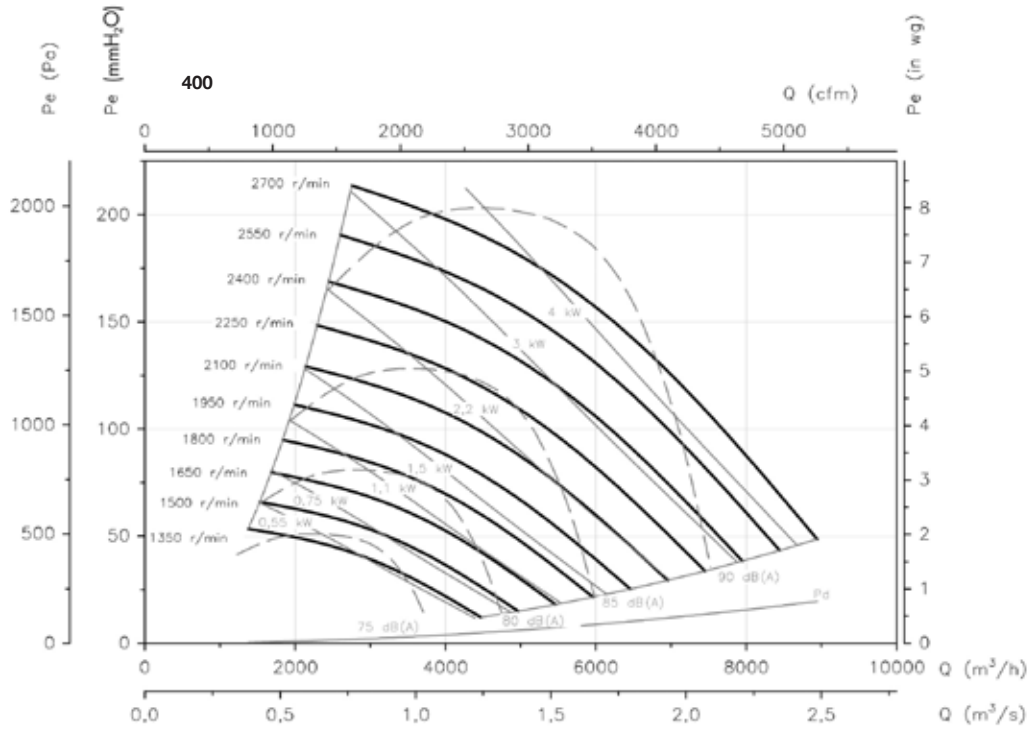

Characteristic curves

Q = Airflow in m³/h, m³/s and cfm.

Pe = Static pressure in mm.w.c., Pa and inwg.

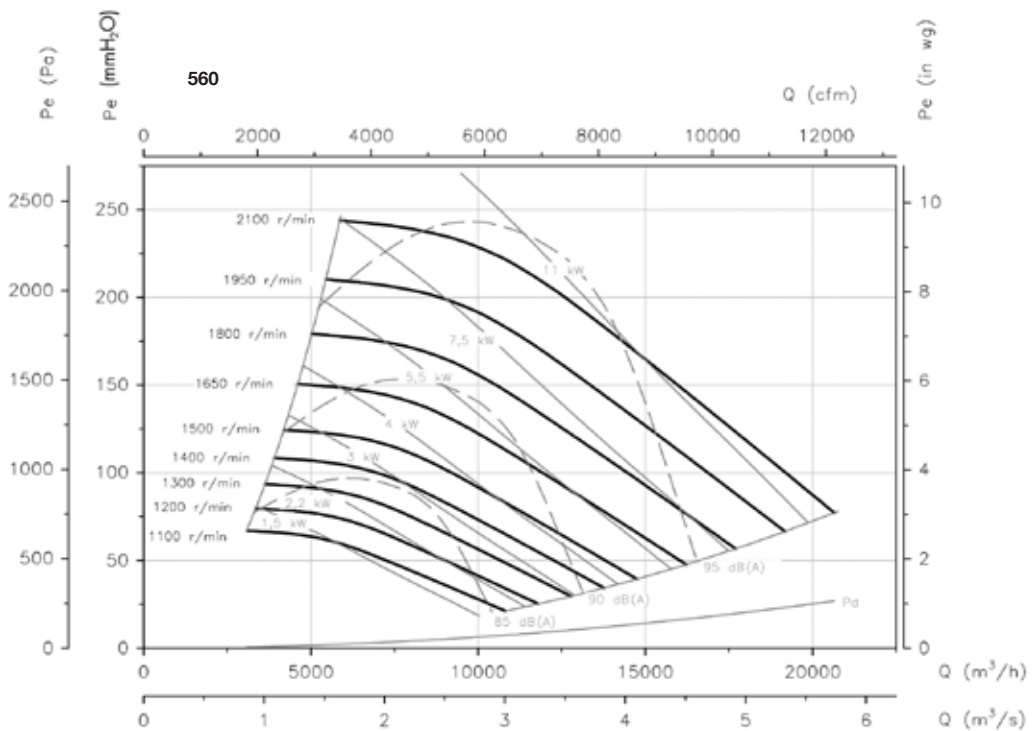
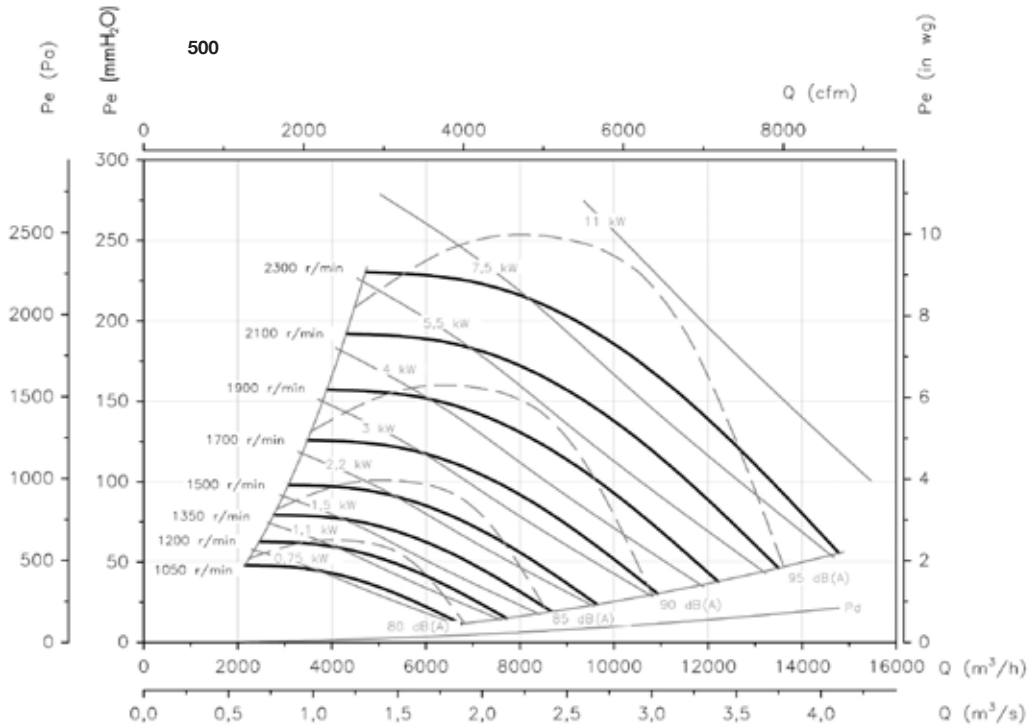

Characteristic curves

Q = Airflow in m³/h, m³/s and cfm.

Pe = Static pressure in mm.w.c., Pa and in wg.

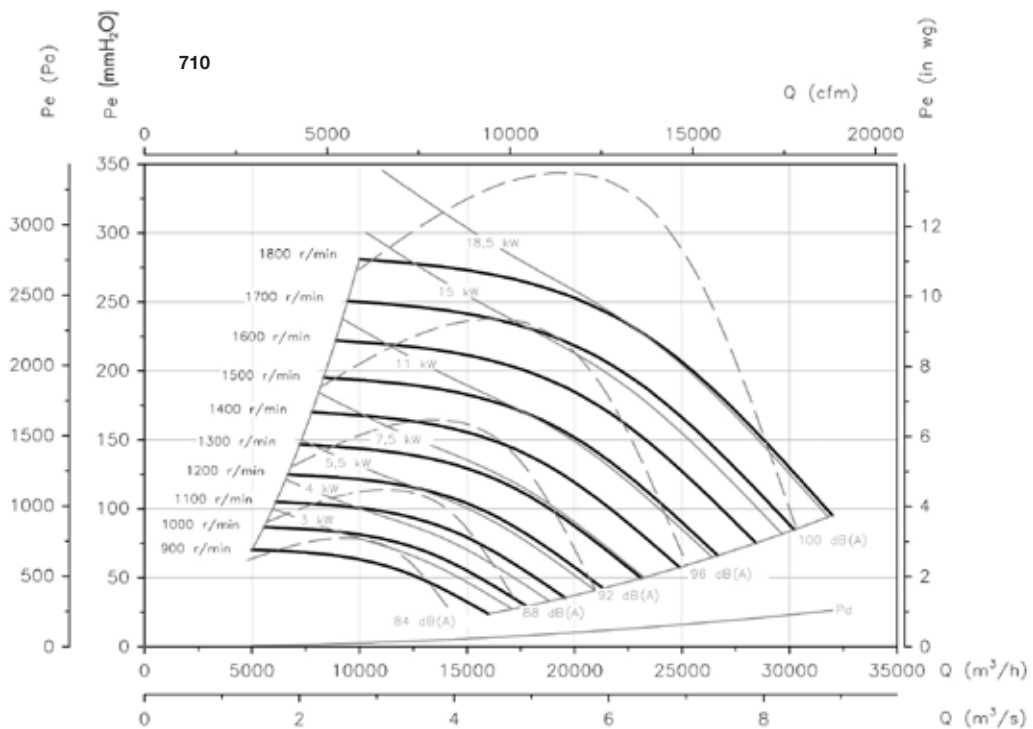
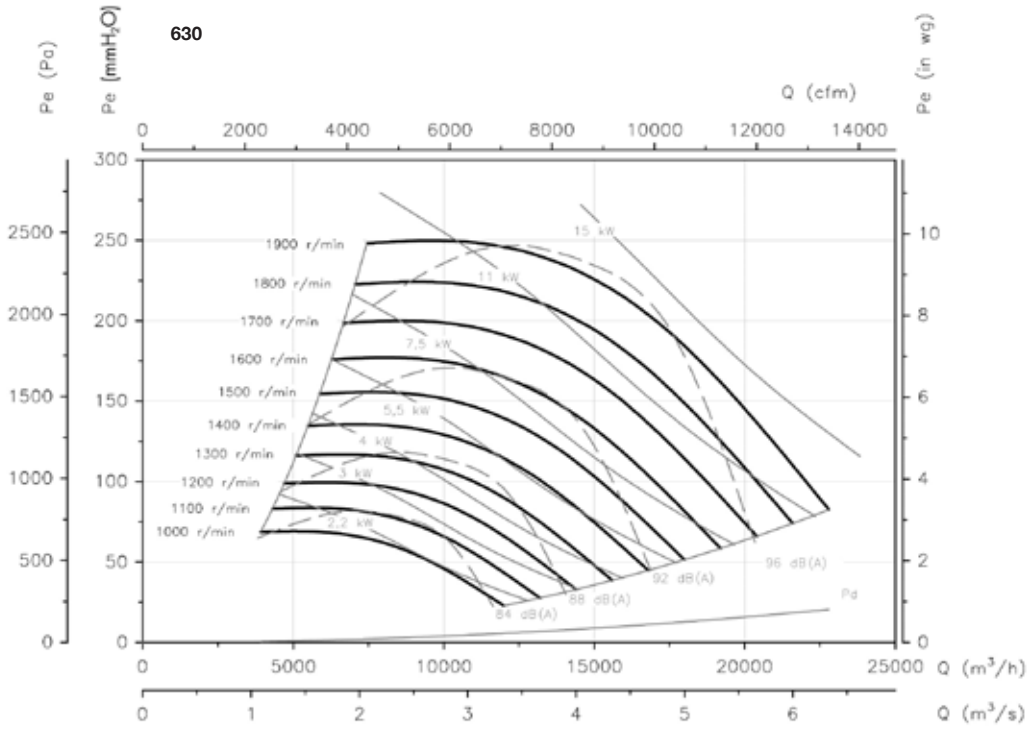

Characteristic curves

Q = Airflow in m³/h, m³/s and cfm.

Pe = Static pressure in mm.w.c., Pa and inwg.

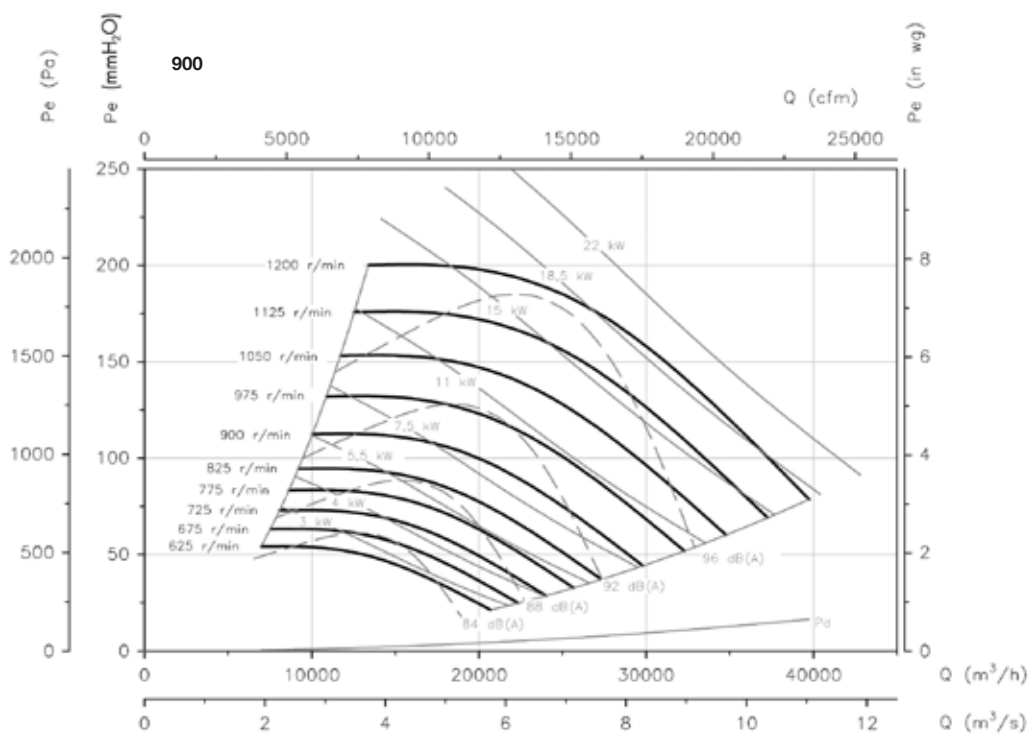
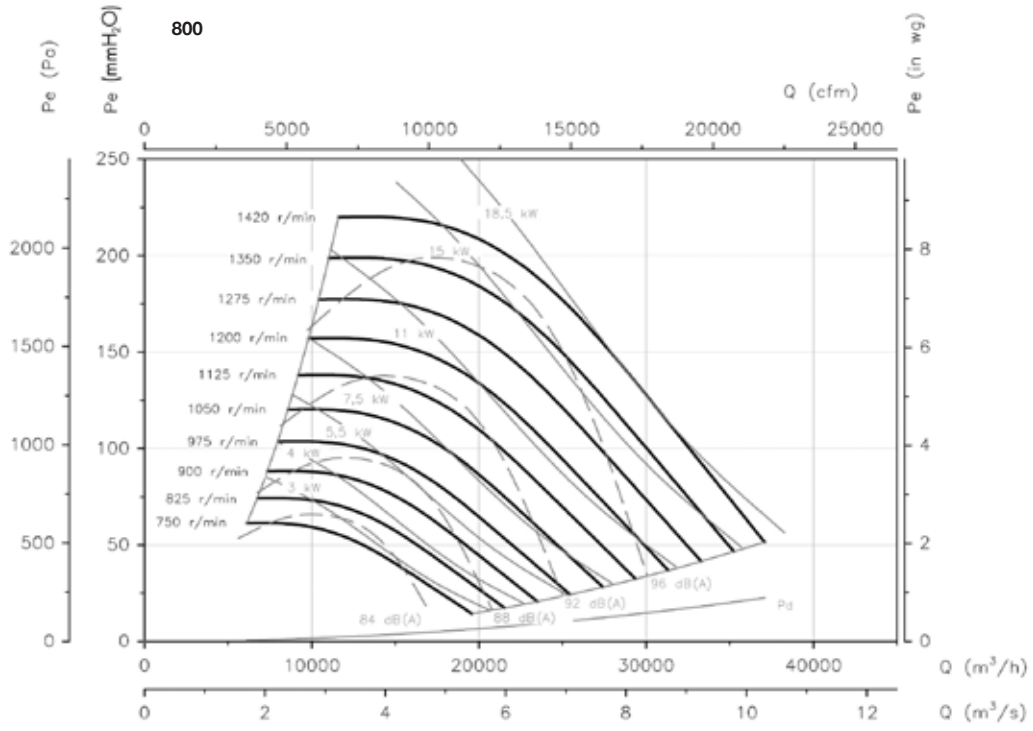

Characteristic curves

Q = Airflow in m³/h, m³/s and cfm.

Pe = Static pressure in mm.w.c., Pa and inwg.

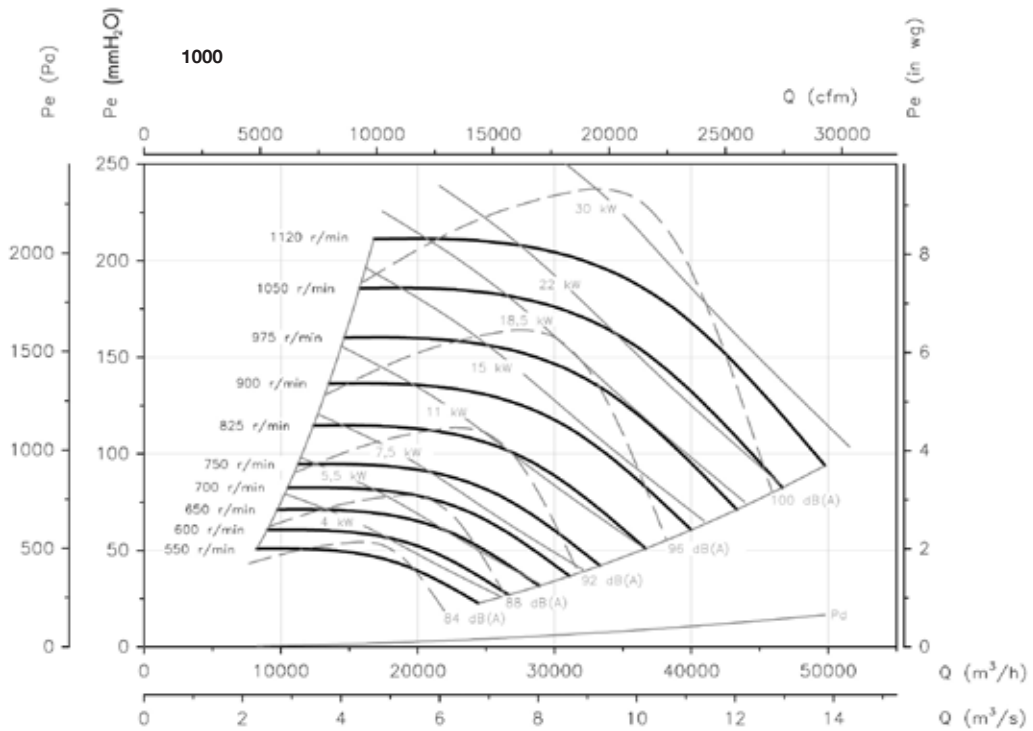

Accessories

See accessories section



CJSRX



High-performance and robust backward-curved impeller.

400°C/2h belt-driven extraction units to work outside fire danger zones with backward-curved impeller

400°C/2h centrifugal belt-driven fans with backward-curved impeller with electric motor, pulley, belt kit and standardised protectors accordance with standard EN-294 and ISO-13852

Fan:

- Steel sheet casing
- Impeller with backward-curved blades made from sheet steel
- Approval according to Standard EN-12101-3:2002, certificate no.: 0370-CPD-1578
- Pulley and belt kit and standardised protectors in accordance with standard EN-294 and ISO-13852

Motor:

- Motors with IE-2 efficiency, except for motors with lower powers than 0.75 kW and single-phase motors.
- Class F motors, with bearings, IP55 protection.
- Three-phase 230/400V.-50Hz. (up to 5.5CV.) and 400/690V.-50Hz. (power over 5.5CV.)
- Max. air temperature to transport: -20°C.+ 150°C.

Finish:

- Anticorrosive galvanized sheet steel
- On request:
 - Special windings for different voltages



Order code



CJSRX: 400°C/2h belt-driven extraction units with backward-curved impeller

Impeller size

Motor power (c.v.)

F-400: Officially approved 400°C/2h

Technical characteristics

Model	Speed (r/min)	Maximum admissible current (A)			Installed power (kW)	Maximum airflow (m³/h)	Approx. weight (Kg)
		230V	400V (A)	690V			
CJSRX-315-0.5	1650	1.84	1.06		0.37	2700	83
CJSRX-315-0.75	1880	2.57	1.49		0.55	3075	85
CJSRX-315-1	2095	2.78	1.60		0.75	3430	87
CJSRX-315-1.5	2375	4.20	2.40		1.10	3885	89
CJSRX-315-2	2655	5.44	3.13		1.50	4345	92
CJSRX-315-3	3000	7.77	4.47		2.20	4910	95
CJSRX-315-4	3380	10.18	5.88		3.00	5530	100
CJSRX-355-0.5	1385	1.84	1.06		0.37	3235	100
CJSRX-355-0.75	1580	2.57	1.49		0.55	3685	102
CJSRX-355-1	1765	2.78	1.60		0.75	4120	105
CJSRX-355-1.5	2010	4.20	2.40		1.10	4690	107
CJSRX-355-2	2225	5.44	3.13		1.50	5190	109
CJSRX-355-3	2530	7.77	4.47		2.20	5905	114
CJSRX-355-4	2860	10.18	5.88		3.00	6675	118
CJSRX-355-5.5	3100	13.60	7.82		4.00	7235	124
CJSRX-400-0.75	1320	2.28	1.31		0.55	4375	119
CJSRX-400-1	1465	3.10	1.79		0.75	4855	122
CJSRX-400-1.5	1665	4.03	2.32		1.10	5515	124
CJSRX-400-2	1845	5.96	3.44		1.50	6110	126
CJSRX-400-3	2100	8.36	4.83		2.20	6955	129
CJSRX-400-4	2370	10.18	5.88		3.00	7850	134
CJSRX-400-5.5	2610	13.60	7.82		4.00	8645	142

Technical characteristics

Model	Speed (r/min)	Maximum admissible current (A)			Installed power (kW)	Maximum airflow (m³/h)	Approx. weight (Kg)
		230V	400V (A)	690V			
CJSRX-450-0.75	1095	2.28	1.31		0.55	5045	140
CJSRX-450-1	1220	3.10	1.79		0.75	5620	143
CJSRX-450-1.5	1390	4.03	2.32		1.10	6405	145
CJSRX-450-2	1540	5.96	3.44		1.50	7095	147
CJSRX-450-3	1750	8.36	4.83		2.20	8065	151
CJSRX-450-4	1980	10.18	5.88		3.00	9120	155
CJSRX-450-5.5	2180	13.60	7.82		4.00	10045	164
CJSRX-450-7.5	2420		10.50	6.09	5.50	11150	174
CJSRX-450-10	2670		14.50	8.41	7.50	12300	179
CJSRX-500-1	1005	3.10	1.79		0.75	6465	178
CJSRX-500-1.5	1140	4.03	2.32		1.10	7330	180
CJSRX-500-2	1270	5.96	3.44		1.50	8165	182
CJSRX-500-3	1445	8.36	4.83		2.20	9290	185
CJSRX-500-4	1635	10.96	6.33		3.00	10510	190
CJSRX-500-5.5	1800	14.10	8.12		4.00	11570	199
CJSRX-500-7.5	2000		10.50	6.09	5.50	12855	208
CJSRX-500-10	2220		14.50	8.41	7.50	14270	213
CJSRX-500-15	2300		20.20	11.60	11.00	14785	247
CJSRX-560-2	1035	5.96	3.44		1.50	9885	207
CJSRX-560-3	1185	8.36	4.83		2.20	11360	210
CJSRX-560-4	1340	10.96	6.33		3.00	12880	215
CJSRX-560-5.5	1475	14.10	8.12		4.00	14210	224
CJSRX-560-7.5	1640		11.60	6.72	5.50	15830	229
CJSRX-560-10	1815		14.50	8.41	7.50	17555	239
CJSRX-560-15	2065		20.20	11.60	11.00	20010	273
CJSRX-630-3	1010	8.36	4.83		2.20	12120	241
CJSRX-630-4	1140	10.96	6.33		3.00	13680	245
CJSRX-630-5.5	1255	14.10	8.12		4.00	15060	254
CJSRX-630-7.5	1395		11.60	6.72	5.50	16740	260
CJSRX-630-10	1550		14.50	8.41	7.50	18600	269
CJSRX-630-15	1760		20.20	11.60	11.00	21120	303
CJSRX-630-20	1900		27.50	15.90	15	22800	324
CJSRX-710-4	960	10.96	6.33		3.00	17065	337
CJSRX-710-5.5	1060	14.10	8.12		4.00	18845	346
CJSRX-710-7.5	1180		11.60	6.72	5.50	20980	351
CJSRX-710-10	1305		14.20	8.20	7.50	23200	361
CJSRX-710-15	1485		20.20	11.60	11.00	26400	395
CJSRX-710-20	1670		27.50	15.90	15.00	29690	416
CJSRX-710-25	1750		35.00	20.00	18.50	31110	436



Erp. BEP (best efficiency point) characteristics

Available features best efficiency point (BEP), CSX series

Dimensions in mm

Standard supply horizontal outlet (H) RD 90

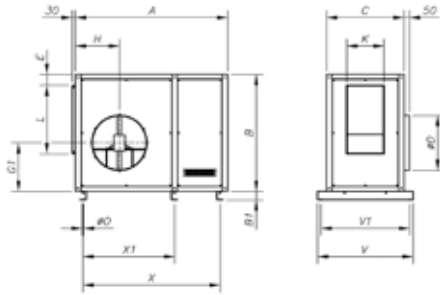

On request horizontal outlet (H) LG 90

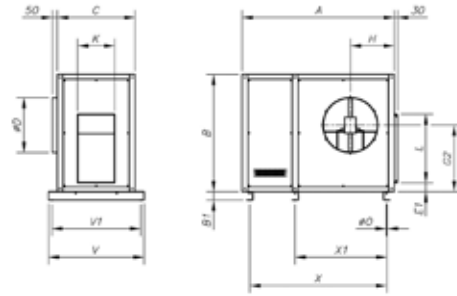

On request vertical outlet (V) RD 0

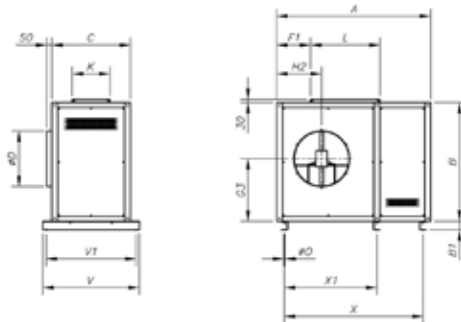

On request vertical outlet (V) LG 0

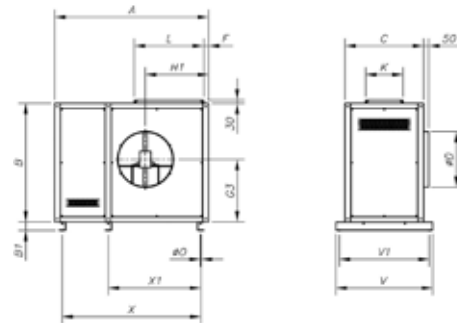

	A	B	B1	C	ØD	E	E1	F	F1	G1	G2	G3	H	H1	H2	L	K	V	X	X1	X2
CJSRX-315	1170	740	60	600	315	82	84.2	113	281	317.5	423.2	366.2	305	451.5	346.3	405	224	760	880	-	155
CJSRX-355	1265	815	60	650	365	85	86.5	112.5	302.5	347.2	470.2	398	338	496	373	454	248	810	1020	-	152
CJSRX-400	1370	900	60	680	400	82	90.2	111	331	386.2	522.2	447.2	359	543	407	508	275	840	1120	-	152
CJSRX-450	1480	990	60	716	448	82	91.2	112.8	360	422.2	577.2	491	383	598	443	570	309	876	1240	-	152
CJSRX-500	1625	1080	60	760	510	80.5	91	111.7	381.3	461.2	629.2	534.2	409	650	482	639	345	920	1340	670	152
CJSRX-560	1760	1195	60	810	580	86.8	94.2	128	426	506.2	696.2	590	462	731	540	716	384	970	1490	745	152
CJSRX-630	1880	1322	60	850	635	85.2	89.6	113.4	455.6	557.7	768.7	648.2	488	792.5	578.5	802	433	1010	820	1610	158
CJSRX-710	2180	1500	80	910	710	103	108.2	100	491	632.2	873.2	737.2	562	865	624	899	479	1070	955	1910	168

Characteristic Curves

See characteristic curves, CSX series.

Accessories

See accessories section



CJLINE

400°C/2h extraction units with linear inlet and outlet

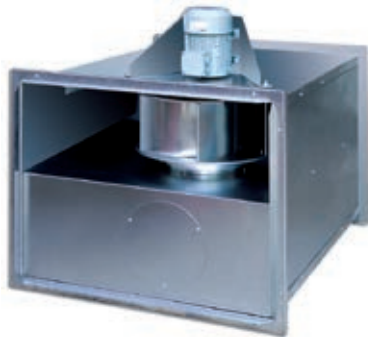

Easy to connect to rectangular ducts.

400°C/2h in-line extraction units to work outside the fire danger zone.

Fan:

- Galvanized sheet steel structure.
- Impeller with backward-curved blades made from sheet steel
- Approval according to Standard EN-12101-3-2002, certificate no.: 0370-CPD-0594
- Linear air circulation

Motor:

- Class F motors with ball bearings, IP55 protection, one- or two-speed depending on the model
- Three-phase 230/400V.-50Hz. (up to 5.5CV.) and 400/690V.-50Hz. (power over 5.5CV.)
- Max. temperature of air for transport: S1 Service -20°C+ 120°C for ongoing use, S2 Service 200°C/2h, 300°C/2h and 400°C/2h

Finish:

- Anticorrosive galvanized sheet steel.

On request:

- Fans with two-speed motor.



Order code

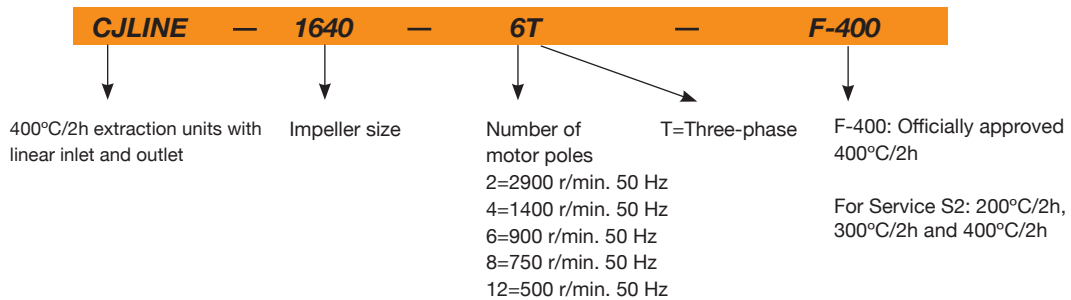

Technical characteristics

Model	Speed (r/min)	Maximum admissible current (A)			Power installed (kW)	Airflow maximum (m³/h)	Sound pressure level dB(A)	Approx. weight (Kg)
		230V	400V (A)	690V				
CJLINE-1131-4T	1350	1.66	0.96		0.25	1920	51	39
CJLINE-1131-4/8T	1400/700		0.70 / 0.30		0.25/0.10	1920/960	51/36	40
CJLINE-1235-4T	1350	1.66	0.96		0.25	3550	56	54
CJLINE-1235-4/8T	1400/700		0.70 / 0.30		0.25/0.10	3550/1775	56/41	55
CJLINE-1235-6T	880	1.22	0.70		0.18	2300	50	55
CJLINE-1640-4T	1370	2.02	1.17		0.37	4800	61	65
CJLINE-1640-4/8T	1440/700		1.05 / 0.50		0.37/0.11	4800/2400	61/46	67
CJLINE-1640-6T	900	1.51	0.87		0.25	2950	54	66
CJLINE/H-1650-4T	1430	5.96	3.44		1.50	9650	74	99
CJLINE-1845-4T	1410	3.10	1.79		0.75	6800	65	83
CJLINE-1845-4/8T	1430/710		2.00 / 0.90		0.75/0.20	6800/3400	65/50	84
CJLINE-1845-6T	900	2.24	1.30		0.37	4360	57	81
CJLINE/H-1856-4T	1445	10.96	6.33		3.00	13580	77	117
CJLINE-1856-6T	900	2.99	1.73		0.55	7720	59	142
CJLINE-1856-6/12T	930/450		1.60 / 0.65		0.55/0.09	7720/3860	59/44	143
CJLINE-1856-8T	695	1.94	1.12		0.25	5800	52	143
CJLINE/H-2063-4T	1440		11.60	6.72	5.50	20900	79	228
CJLINE-2063-6T	945	3.90	2.20		0.75	11100	61	185

Technical characteristics

Model	Speed (r/min)	Maximum admissible current (A)			Power installed (kW)	Airflow maximum (m³/h)	Sound pressure level dB(A)	Approx. weight (Kg)
		230V	400V (A)	690V				
CJLINE-2063-6/12T	935/435	2.20 / 0.87			0.75/0.15	11100/5550	61/46	190
CJLINE-2063-8T	700	2.77	1.60		0.37	7730	54	188
CJLINE/H-2271-4T	1460		20.20	11.60	11.00	31170	84	283
CJLINE-2271-6T	955	6.42	3.71		1.50	14300	65	205
CJLINE-2271-6/12T	970/470	4.60 / 1.90			1.50/0.25	14300/7150	65/50	216
CJLINE-2271-8T	705	4.68	2.70		0.75	9900	57	204
CJLINE-2880-6T	960	12.70	7.30		3.00	22800	67	275
CJLINE-2880-6/12T	960/480	9.00 / 3.50			3.00/0.55	22800/11400	67/52	289
CJLINE-2880-8T	705	9.53	5.50		2.20	17200	58	275



Erp. BEP (best efficiency point) characteristics

MC	Measurement category	ηe[%]	Efficiency
EC	Efficiency category	N	Efficiency grade
S	Static	[kW]	Input power
T	Total	[m³/h]	Airflow
VSD	Variable-speed drive	[mmH²O]	Static or total pressure (According to EC)
SR	Specific ratio	[RPM]	Speed

Model	MC	EC	VSD	SR	ηe[%]	N	(kW)	(m³/h)	(mmH ₂ O)	(RPM)
CJLINE-1131-4T	C	S	NO	1.00	41.2%	59.2	0.187	1246	22.75	1430
CJLINE-1131-4/8T	C	S	NO	1.00	43.7%	61.9	0.186	1269	23.59	1456
CJLINE-1235-4T	C	S	NO	1.00	48.5%	63.1	0.330	2218	26.47	1354
CJLINE-1235-4/8T	C	S	NO	1.00	51.4%	66.2	0.350	2307	28.63	1408
CJLINE-1235-6T	C	S	NO	1.00	62.0%	83.7	0.089	1338	15.13	966
CJLINE-1640-4T	C	S	NO	1.00	47.8%	61.3	0.451	2214	35.73	1393
CJLINE-1640-4/8T	C	S	NO	1.00	50.5%	64.3	0.485	2311	38.90	1453
CJLINE-1640-6T	C	S	NO	1.00	55.9%	74.5	0.175	1785	20.18	959
CJLINE/H-1650-4T	C	S	NO	1.01	52.3%	61.4	1.399	4746	56.59	1462
CJLINE-1845-4T	C	S	NO	1.00	64.6%	75.7	0.863	5376	38.07	1436
CJLINE-1845-4/8T	C	S	NO	1.00	55.6%	66.0	1.015	5399	38.40	1442
CJLINE-1845-6T	C	S	NO	1.00	48.9%	63.6	0.383	3346	20.55	935
CJLINE/H-1856-4T	C	S	NO	1.01	53.3%	59.5	2.704	6685	79.17	1472
CJLINE-1856-6T	C	S	NO	1.00	49.0%	60.3	0.731	4768	27.62	909
CJLINE-1856-6/12T	C	S	NO	1.00	49.0%	60.3	0.799	4911	29.30	936
CJLINE-1856-8T	C	S	NO	1.00	46.4%	61.4	0.302	4441	11.59	701
CJLINE/H-2063-4T	C	S	NO	1.01	67.6%	71.6	4.336	9344	115.11	1473
CJLINE-2063-6T	C	S	NO	1.00	60.6%	71.2	1.001	4849	45.92	957
CJLINE-2063-6/12T	C	S	NO	1.00	53.8%	63.9	1.077	4776	44.57	943
CJLINE-2063-8T	C	S	NO	1.00	46.4%	59.3	0.488	3908	21.29	702
CJLINE/H-2271-4T	C	S	NO	1.01	61.5%	61.7	10.225	18767	123.11	1479
CJLINE-2271-6T	C	S	NO	1.00	56.1%	63.8	1.925	7551	52.49	967
CJLINE-2271-6/12T	C	S	NO	1.00	51.6%	59.0	2.149	7621	53.48	976
CJLINE-2271-8T	C	S	NO	1.00	48.9%	59.3	0.888	6062	26.31	713
CJLINE-2880-6T	C	S	NO	1.01	62.7%	68.1	3.351	12895	59.85	975
CJLINE-2880-6/12T	C	S	NO	1.01	54.4%	59.1	3.816	12845	59.39	971
CJLINE-2880-8T	C	S	NO	1.00	58.0%	65.5	1.774	10729	35.22	726

Facts internal Plug Fan

Acoustic features

The specified values are determined according to free field measurements of pressure and sound levels in dB(A) at an equivalent distance of twice the fan's span plus the turbine's diameter, with a minimum of 1.5 m.

Sound power Lw(A) spectrum in dB(A) via frequency band in Hz.

Model	63	125	250	500	1000	2000	4000	8000	Model	63	125	250	500	1000	2000	4000	8000
CJLINE 1131-4	42	51	57	56	60	60	52	46	CJLINE 1856-8	51	57	62	63	66	65	58	53
CJLINE 1131-8	27	36	42	41	45	45	37	31	CJLINE 1856-12	43	49	54	55	58	57	50	45
CJLINE 1235-4	49	58	64	63	67	66	59	53	CJLINE/H 2063-4	81	86	93	94	93	90	83	75
CJLINE 1235-6	43	52	58	57	61	60	53	47	CJLINE 2063-6	60	66	72	72	76	76	68	61
CJLINE 1235-8	34	43	59	48	52	51	44	38	CJLINE 2063-8	53	59	65	65	69	69	61	54
CJLINE 1640-4	56	62	67	68	71	73	65	59	CJLINE 2063-12	45	51	57	57	61	61	53	46
CJLINE 1640-6	49	55	60	61	64	66	58	52	CJLINE/H 2271-4	83	84	93	96	99	99	95	82
CJLINE 1640-8	41	47	52	53	56	58	50	44	CJLINE 2271-6	64	70	76	76	80	80	72	65
CJLINE/H 1650	64	74	82	84	83	85	76	66	CJLINE 2271-8	56	62	68	68	72	72	64	57
CJLINE 1845-4	60	66	71	72	75	77	69	63	CJLINE 2271-12	49	55	61	61	65	65	57	50
CJLINE 1845-6	52	58	63	64	67	69	61	55	CJLINE 2880-6	66	72	78	78	82	82	74	67
CJLINE 1845-8	45	51	56	57	60	62	54	48	CJLINE 2880-8	57	63	69	69	73	73	65	58
CJLINE 1856-6	58	64	69	70	73	72	65	60	CJLINE 2880-12	51	57	63	63	67	67	59	52
CJLINE/H 1856-4	69	77	91	87	90	90	85	71									

Dimensions in mm

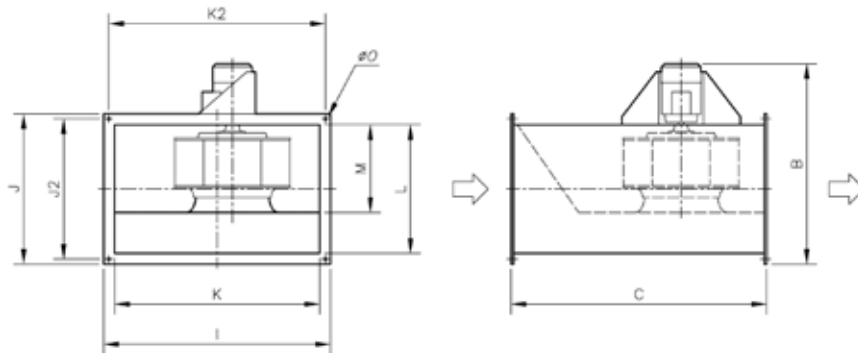

Model	B	C	I	J	J2	K	k2	L	M	ØO
CJLINE-1131	760	710	620	510	483	560	593	450	175	10
CJLINE-1235	830	800	680	560	533	620	653	500	213	10
CJLINE-1640	890	900	770	620	593	710	743	560	262	10
CJLINE-1650/H	942	1000	860	690	663	800	833	630	290	10
CJLINE-1845	1010	1000	860	690	663	800	833	630	290	10
CJLINE-1856	1280	1250	1060	860	833	1000	1033	800	378	10
CJLINE-1856/H	1150	1250	1060	860	833	1000	1033	800	378	10
CJLINE-2063	1390	1400	1205	980	938	1125	1163	900	378	12
CJLINE-2063/H	1320	1400	1205	980	938	1125	1163	900	378	12
CJLINE-2271	1470	1400	1270	980	938	1190	1228	900	378	12
CJLINE-2271/H	1518	1400	1270	980	938	1190	1228	900	378	12
CJLINE-2880	1590	1500	1330	1080	1038	1250	1288	1000	490	12

Characteristic curves

Q = Airflow in m³/h, m³/s and cfm.

Pe = Static pressure in mm.w.c., Pa and inwg.

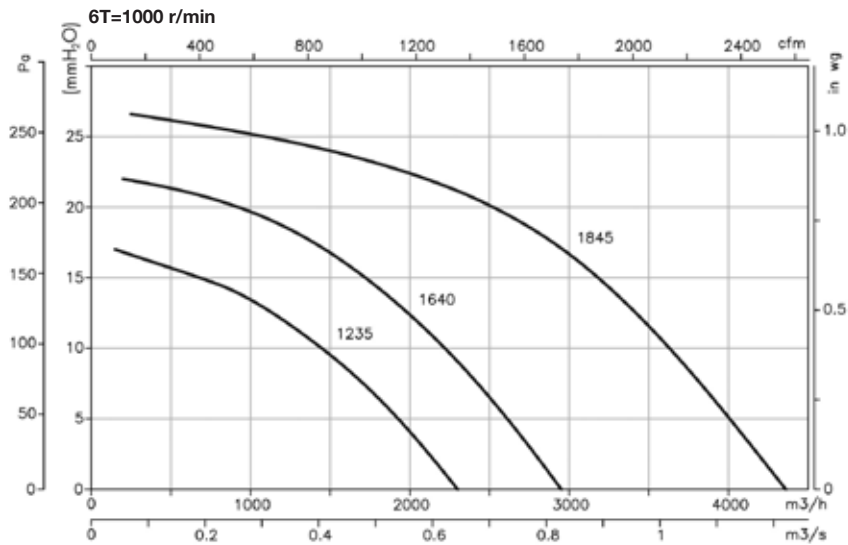
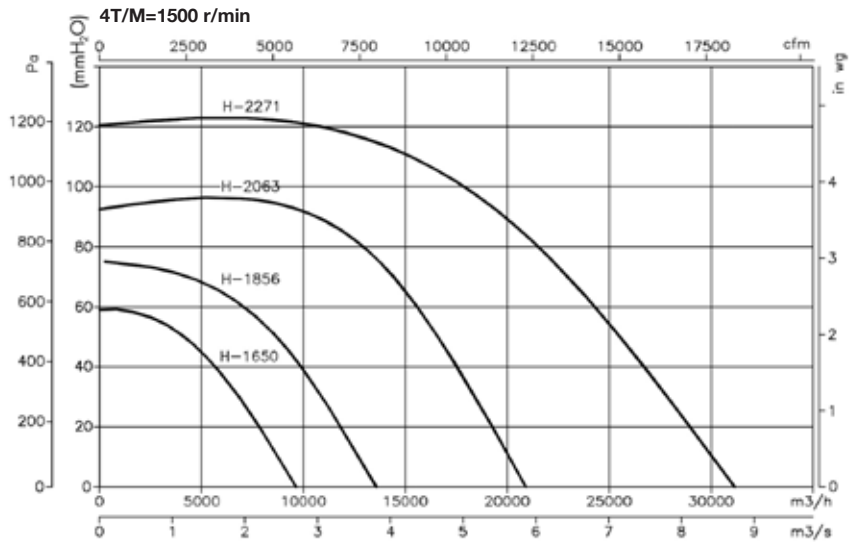
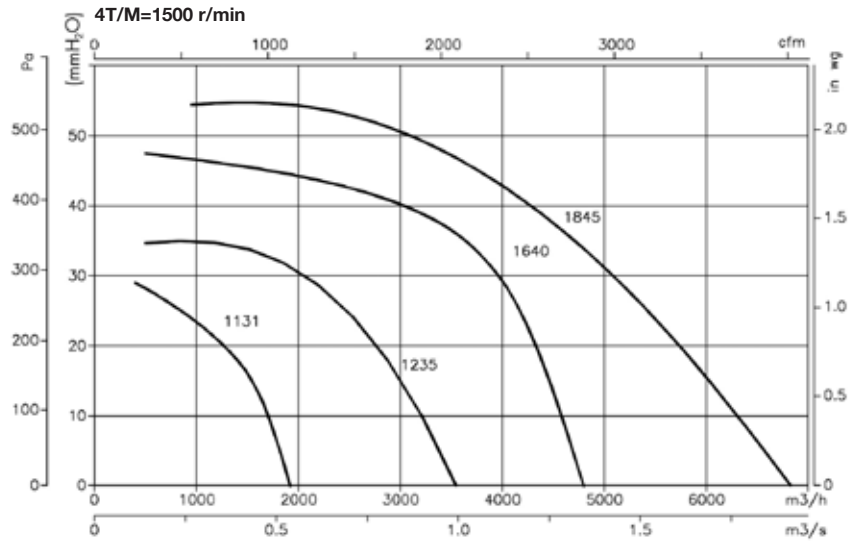

Characteristic curves

Q = Airflow in m³/h, m³/s and cfm.

Pe= Static pressure in mm.w.c., Pa and inwg.

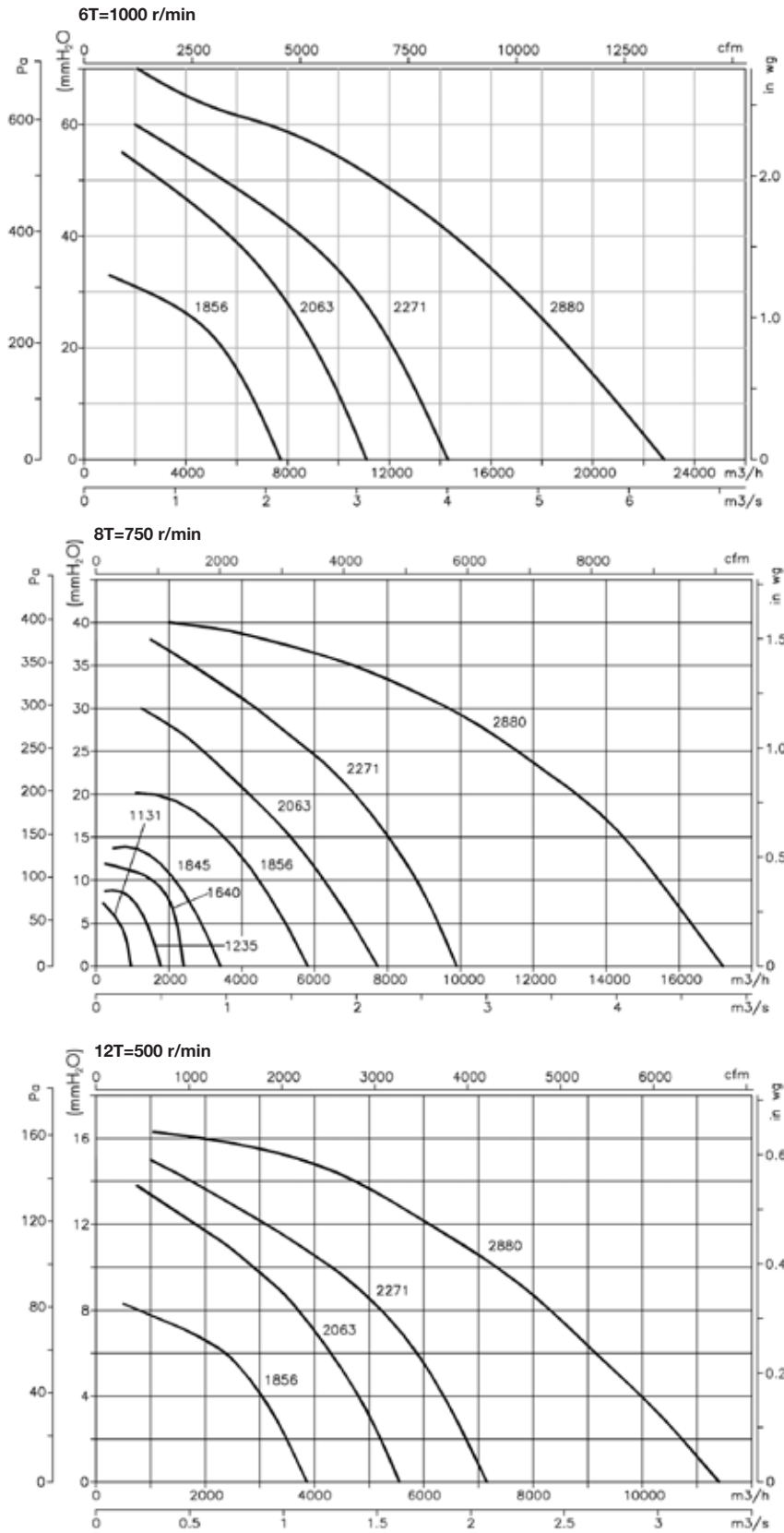

Accessories

See accessories section



INT CABLE BOX C2V AET AR CENTRAL CO RFT TAC VIS

CJEC

400°C/2h extraction units with large hatch to facilitate maintenance.



Motor-impeller unit easy to dismantle

Extraction units with large hatch to facilitate maintenance.

Fan:

- Galvanized sheet steel structure.
- Impeller with backward-curved blades made from galvanised sheet steel
- Approval according to Standard EN-12101-3-2002 certification No.: 0370-CPD-0382
- Possibility of mounting the outlet on either side of the box during installation.

Motor:

- Class F two-speed motors with ball bearings, IP55 protection
- Three-phase 400V.-50Hz. DHALANDER
- Max. air temperature to transport: -20°C + 120°C

Finish:

- Anticorrosive galvanized sheet steel

On request:

- With single-speed motors.



Order code



Extraction units with large hatch to facilitate maintenance

Impeller size

Number of motor poles
6=900 r/min 50 Hz
8=2900 r/min 50 Hz
4=1400 r/min 50 Hz

6=900 r/min 50 Hz
8=750 r/min 50 Hz
12=500 r/min 50 Hz

M= Single-phase
T=Three-phase

Technical characteristics

Model	Speed (r/min)	Maximum admissible current (A)		Installed power (kW)	Maximum airflow (m³/h)	Sound level dB(A)		Approx. weight (Kg)
		230V	400V			Inlet	Outlet	
CJEC-280-4/8T	1380 / 720		0.60 / 0.70	0.18 / 0.04	1370 / 685	55 / 40	60 / 45	61
CJEC-280-4M	1380	0.65		0.25	1370	55	60	61
CJEC-315-4/8T	1440 / 700		1.05 / 0.50	0.37 / 0.11	1650 / 825	59 / 44	63 / 48	63
CJEC-315-4M	1380	0.95		0.25	1650	59	63	63
CJEC-355-4/8T	1440 / 700		1.05 / 0.50	0.37 / 0.11	3000 / 1500	61 / 46	66 / 51	75
CJEC-355-4M	1380	1.35		0.25	3000	61	66	75
CJEC-400-4/8T	1450 / 720		1.70 / 0.80	0.55 / 0.19	4000 / 2000	65 / 50	69 / 54	79
CJEC-400-4M	1380	3.30		0.55	4000	65	69	79
CJEC-450-4/8T	1430 / 710		2.00 / 0.90	0.75 / 0.20	5500 / 2750	68 / 53	72 / 57	89
CJEC-450-4M	1380	4.40		0.75	5500	68	72	89
CJEC-500-4/8T	1420 / 700		3.50 / 1.50	1.50 / 0.37	7600 / 3800	70 / 55	75 / 60	110
CJEC-560-6/12T	940 / 460		3.50 / 1.20	1.30 / 0.20	9500 / 4750	77 / 62	82 / 67	129



Erp. BEP (best efficiency point) characteristics

MC	EC	VSD	SR	ne[%]	N	(kW)	(m³/h)	(mmH ₂ O)	(RPM)
Measurement category	Efficiency category	Variable-speed drive	Specific ratio	Efficiency	Efficiency grade	Input power	Airflow	Static or total pressure (According to EC)	Speed
S	Static			[kW]					
T	Total			[m³/h]					
				[mmH ₂ O]					
				[RPM]					

Model	MC	EC	VSD	SR	ne[%]	N	(kW)	(m³/h)	(mmH ₂ O)	(RPM)
CJEC-280-4/8T	-	-	-	-	-	-	0.114	858	18.92	1460
CJEC-280-4M	-	-	-	-	-	-	0.097	836	17.95	1422
CJEC-315-4/8T	C	S	NO	1.00	49.2%	67.9	0.167	1241	24.28	1474
CJEC-315-4M	C	S	NO	1.00	41.5%	59.9	0.177	1197	22.58	1421
CJEC-355-4/8T	C	S	NO	1.00	51.6%	67.8	0.292	1765	31.32	1469
CJEC-355-4M	C	S	NO	1.00	43.6%	59.6	0.299	1683	28.45	1400
CJEC-400-4/8T	C	S	NO	1.00	48.5%	61.1	0.630	3391	33.11	1463
CJEC-400-4M	C	S	NO	1.00	46.6%	59.3	0.608	3305	31.45	1426
CJEC-450-4/8T	C	S	NO	1.00	49.8%	60.2	1.028	4749	39.64	1432
CJEC-450-4M	C	S	NO	1.00	49.5%	60.0	0.994	4684	38.56	1412
CJEC-500-4/8T	C	S	NO	1.01	50.4%	58.9	1.545	4846	59.02	1447
CJEC-560-6/12T	C	S	NO	1.00	51.2%	64.4	0.549	4670	22.08	1009

Facts internal Plug Fan

Acoustic features

The specified values are determined according to free field measurements of pressure and sound levels in dB(A) at an equivalent distance of twice the fan's span plus the turbine's diameter, with a minimum of 1.5 m.

Sound power Lw(A) spectrum in dB(A) via frequency band in Hz.

Values taken at inlet with maximum airflow.								Values taken at outlet with maximum airflow.								Model	
63	125	250	500	1000	2000	4000	8000	Model	63	125	250	500	1000	2000	4000	8000	
280-4	42	47	62	59	60	58	53	45	280-4	42	45	65	66	65	65	58	49
280-8	27	32	47	44	45	43	38	30	280-8	27	30	50	51	50	50	43	34
315-4	53	62	64	64	64	62	54	42	315-4	45	59	67	69	68	68	60	53
315-8	38	47	49	49	49	47	39	27	315-8	30	44	52	54	53	53	45	38
355-4	52	62	68	63	64	66	62	53	355-4	48	67	68	71	72	71	64	55
355-8	37	47	53	48	49	51	47	38	355-8	33	52	53	56	57	56	49	40
400-4	60	69	72	65	68	69	65	56	400-4	52	70	73	73	75	74	70	59
400-8	45	54	57	50	53	54	50	41	400-8	37	55	58	58	60	59	55	44
450-4	56	65	71	76	72	71	65	57	450-4	56	69	75	77	79	76	71	61
450-8	56	69	75	77	79	76	71	61	450-8	41	54	60	62	64	61	56	46
500-4	57	62	73	76	76	75	69	60	500-4	58	67	78	79	83	80	74	63
500-8	42	47	58	61	61	60	54	45	500-8	43	52	63	64	68	65	59	48
560-6	69	78	80	81	82	82	79	57	560-6	65	79	85	86	90	86	81	72
560-12	54	63	65	66	67	67	64	57	560-12	50	64	70	71	75	71	66	57

Dimensions in mm

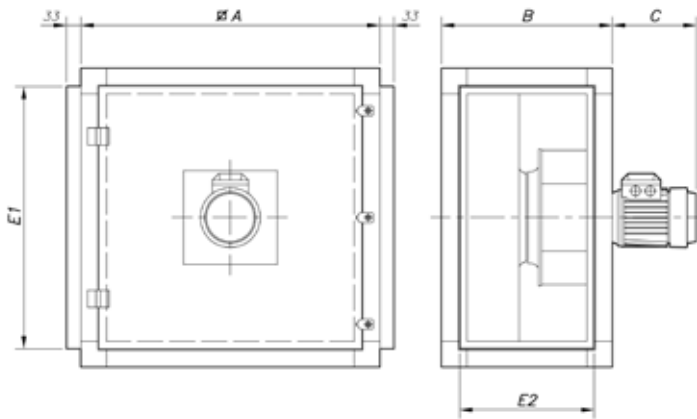

Model	ØA	B	C	E1	E2
CJEC-280	700	400	200	618	318
CJEC-315	700	400	200	618	318
CJEC-355	800	505	200	718	423
CJEC-400	800	505	225	718	423
CJEC-450	900	550	225	818	468
CJEC-500	900	550	260	818	468
CJEC-560	1000	700	290	918	618

Characteristic curves

Q = Airflow in m³/h, m³/s and cfm.

Pe = Static pressure in mm.w.c., Pa and inwg.

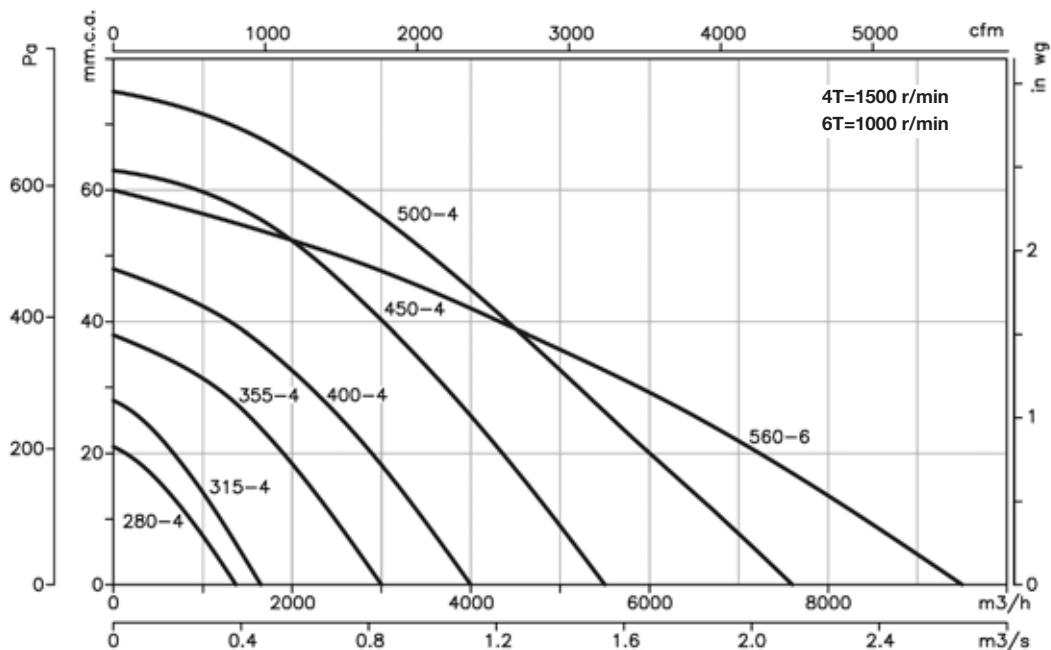

Characteristic curves

Q = Airflow in m³/h, m³/s and cfm.

Pe= Static pressure in mm.w.c., Pa and inwg.

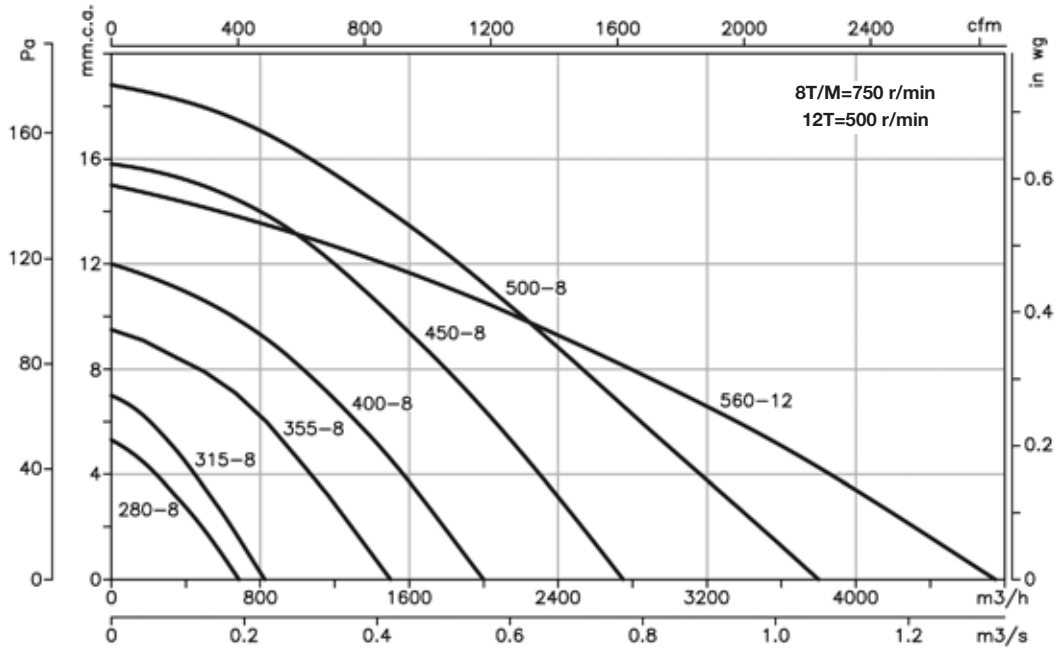

CJEC installations

Possibility of installing the CJEC series by changing the position of the inlet and outlet panels

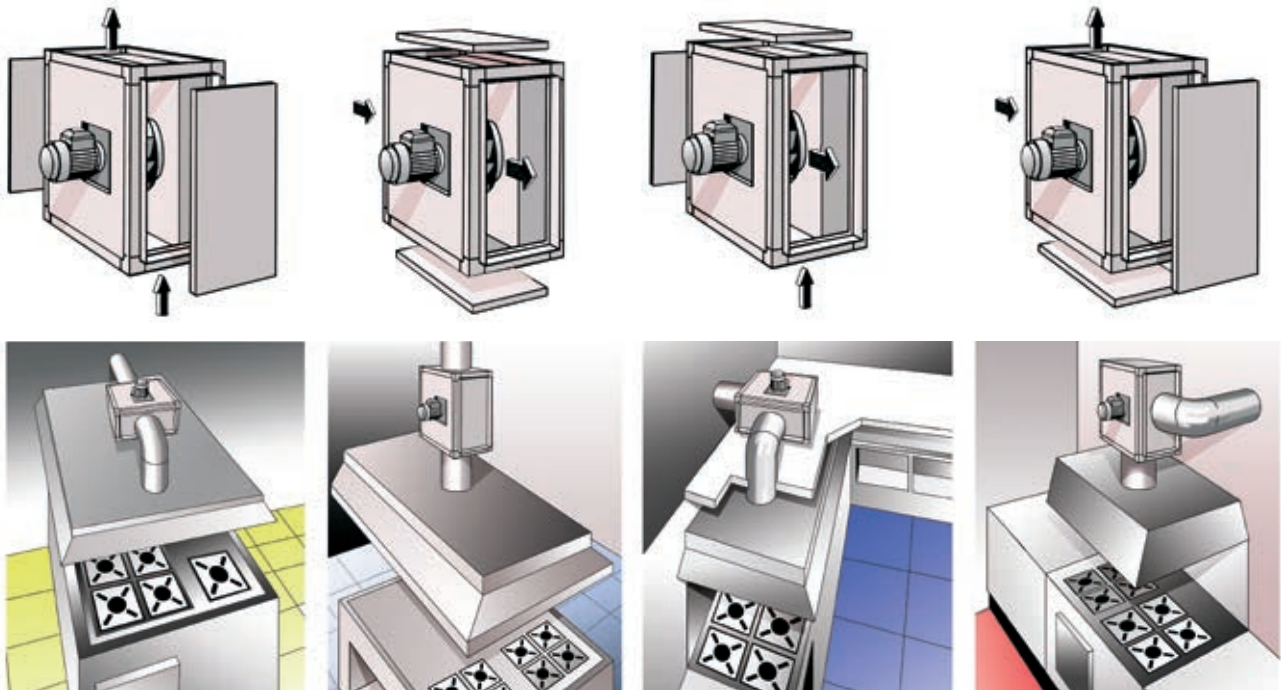

Accessories

See accessories section



CHT CVT

400°C/2h centrifugal roof fans with horizontal or vertical outlet air

CHT: 400°C/2h centrifugal roof fans with horizontal outlet air, hood in aluminium

CVT: 400°C/2h centrifugal roof fans with vertical outlet air, hood in aluminium

Fan:

- Galvanised sheet steel base plate.
- Impeller with backward-curved blades made from galvanised sheet steel
- Bird guard
- Aluminium rain deflector hood
- Approval according to Standard EN-12101-3-2002, certification No.: 0370-CPD-0897

Motor:

- Single-phase two-speed motors with IE-2 efficiency, except lower powers 0.75 kW.
- Class F motors, with ball bearings and IP55 protection, except single-phase versions, IP54 protection, one- or two-speed depending on the model
- Single-phase 230V.-50Hz., and three-phase 230/400V.-50Hz.
- Max. air temperature to transport: -25°C.+ 120°C.

Finish:

- Anticorrosive galvanized sheet steel and aluminium

On request:

- Special windings for different voltages,
- ATEX certification, Category 3



CHT



CVT



Brackets that aid mounting on the roof



Order code

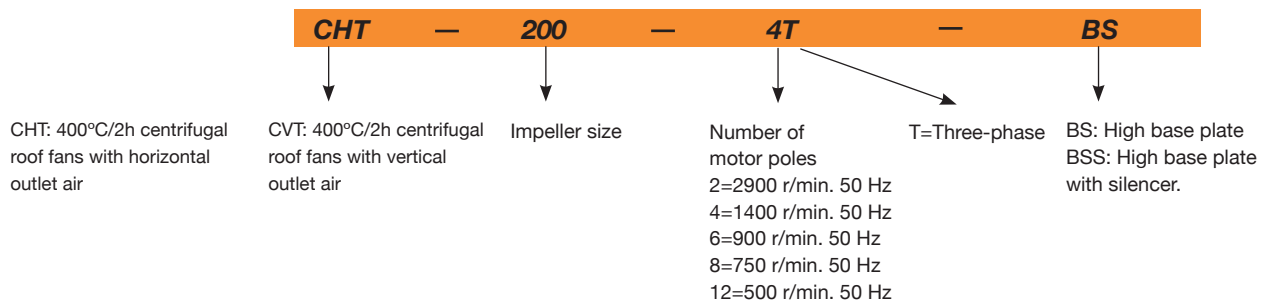

Technical characteristics

Model	Speed (r/min)	Maximum admissible current (A)		Installed power (kW)	Maximum airflow (m³/h)	Sound level dB(A)		Approx. weight (Kg)
		230V	400V			Inlet	Outlet	
CHT CVT 200-4T	1350	1.66	0.96	0.25	1450	37	43	25
CHT CVT 200-4M	1380	0.65		0.25	1450	37	43	25
CHT CVT 225-4T	1350	1.66	0.96	0.25	2100	41	47	25
CHT CVT 225-4M	1380	0.95		0.25	2100	41	47	25
CHT CVT 225-6T	900	1.51	0.87	0.25	1400	30	36	26
CHT CVT 225-6M	890	0.50		0.25	1400	30	36	26
CHT CVT 250-4T	1350	1.66	0.96	0.25	3100	45	50	34
CHT CVT 250-4M	1380	1.35		0.25	3100	45	50	34
CHT CVT 250-6T	900	1.51	0.87	0.25	2000	33	40	35
CHT CVT 250-6M	890	0.65		0.25	2000	33	40	35
CHT CVT 315-4T	1380	2.92	1.69	0.55	4950	48	54	39
CHT CVT 315-4/8T	1450/720		1.70 / 0.80	0.55 / 0.19	4950 / 2475	48 / 33	54 / 39	40

Technical characteristics

Model	Speed (r/min)	Maximum admissible current (A)		Installed power (kW)	Maximum airflow (m³/h)	Sound level dB(A)		Approx. weight (Kg)
		230V	400V			Inlet	Outlet	
CHT CVT 315-4M	1380	3.30		0.55	4950	48	54	39
CHT CVT 315-6T	900	2.24	1.30	0.37	3200	37	43	39
CHT CVT 315-6M	910	0.95		0.37	3200	37	43	39
CHT CVT 400-4T	1410	3.10	1.79	0.75	7000	55	61	57
CHT CVT 400-4/8T	1430 / 710		2.00 / 0.90	0.75 / 0.20	7000 / 3500	55 / 40	61 / 46	58
CHT CVT 400-4M	1380	4.40		0.75	7000	55	61	57
CHT CVT 400-6T	900	2.24	1.30	0.37	4500	44	50	56
CHT CVT 400-6M	910	1.80		0.37	4500	44	50	56
CHT CVT 450-4T	1430	5.96	3.44	1.50	10200	59	64	66
CHT CVT 450-4/8T	1420 / 700		3.50 / 1.50	1.50 / 0.37	10200 / 5100	59 / 43	64 / 49	66
CHT CVT 450-6T	900	2.24	1.30	0.37	6900	47	54	59
CHT CVT 450-6/12T	930 / 450		1.60 / 0.65	0.55 / 0.09	6900 / 3450	47 / 32	54 / 39	63
CHT CVT 450-6M	910	2.00		0.37	6900	47	54	59
CHT CVT 500-6T	945	4.88	2.82	1.10	12000	51	57	103
CHT CVT 500-6/12T	950 / 470		3.00 / 1.15	1.10 / 0.18	12000 / 6000	51 / 36	57 / 42	110
CHT CVT 500-8T	695	3.53	2.04	0.55	8900	44	50	103
CHT CVT 560-6T	955	9.30	5.30	2.20	17300	54	61	126
CHT CVT 560-6/12T	940 / 470		5.60 / 2.20	2.20 / 0.37	17300 / 8650	54 / 39	61 / 46	120
CHT CVT 560-8T	705	5.63	3.25	1.10	12900	46	53	110
CHT CVT 630-6T	960	16.50	9.46	4.00	24700	58	64	166
CHT CVT 630-6/12T	970 / 480		11.00 / 4.00	4.00 / 0.65	24700 / 12350	58 / 43	64 / 49	161
CHT CVT 630-8T	705	7.10	4.10	1.50	18400	50	57	148

(1) The sound level values are measurements of pressure in dB(A) at a distance of 6 m and at 2/3 of the maximum airflow (2/3 Qmax.)



Erp. BEP (best efficiency point) characteristics

MC	Measurement category	ηe[%]	Efficiency
EC	Efficiency category	N	Degree of efficiency
S	Static	[kW]	Electrical power
T	Total	[m³/h]	Airflow
VSD	Variable-speed drive	[mmH₂O]	Static or total pressure (According to EC)
SR	Specific relationship	[RPM]	Speed

Model	MC	EC	VSD	SR	ηe[%]	N	(kW)	(m³/h)	(mmH₂O)	(RPM)
200-4T	-	-	-	-	-	-	0.099	855	17.36	1462
200-4M	-	-	-	-	-	-	0.114	888	18.71	1467
225-4T	C	S	NO	1.00	41.2%	59.9	0.169	1205	21.26	1430
225-4M	C	S	NO	1.00	42.0%	60.1	0.189	1257	23.15	1442
225-6T	-	-	-	-	-	-	0.054	826	10.00	981
225-6M	-	-	-	-	-	-	0.068	875	11.21	986
250-4T	C	S	NO	1.00	45.0%	61.1	0.292	1788	26.99	1359
250-4M	C	S	NO	1.00	43.5%	59.3	0.315	1813	27.75	1377
250-6T	-	-	-	-	-	-	0.106	1262	13.44	959
250-6M	C	S	NO	1.00	40.6%	60.1	0.138	1344	15.26	971
315-4T	C	S	NO	1.00	50.4%	63.3	0.588	2652	41.02	1381
315-4/8T	C	S	NO	1.00	50.2%	62.4	0.690	2794	45.50	1454
315-4M	C	S	NO	1.00	48.1%	60.6	0.653	2705	42.67	1408
315-6T	C	S	NO	1.00	43.4%	61.4	0.192	1689	18.09	956
315-6M	C	S	NO	1.00	45.5%	62.9	0.219	1792	20.35	963
400-4T	C	S	NO	1.00	60.8%	72.4	0.788	4472	39.34	1411
400-4/8T	C	S	NO	1.00	52.3%	63.0	0.956	4536	40.48	1432
400-4M	C	S	NO	1.00	48.3%	59.1	0.942	4343	38.48	1419
400-6T	C	S	NO	1.00	48.9%	64.6	0.319	3148	18.20	926
400-6M	C	S	NO	1.00	51.3%	66.4	0.363	3338	20.46	933
450-4T	C	S	NO	1.01	60.6%	67.9	2.018	7176	62.55	1440
450-4/8T	C	S	NO	1.01	53.3%	60.1	2.254	7133	61.81	1431
450-6T	C	S	NO	1.00	54.1%	66.5	0.667	4779	27.75	959
450-6/12T	C	S	NO	1.00	49.0%	60.7	0.767	4844	28.51	948
450-6M	C	S	NO	1.00	47.6%	59.1	0.796	4854	28.63	925
500-6T	C	S	NO	1.00	62.9%	72.5	1.238	6832	41.88	923
500-6/12T	C	S	NO	1.00	61.7%	70.8	1.372	7023	44.25	957
500-8T	C	S	NO	1.00	47.1%	59.4	0.674	5027	23.21	695
560-6T	C	S	NO	1.01	59.4%	66.1	2.282	9457	52.64	956
560-6/12T	C	S	NO	1.01	53.4%	59.9	2.422	9313	51.05	942
560-8T	C	S	NO	1.00	53.0%	63.2	1.060	7052	29.27	713
630-6T	C	S	NO	1.01	63.0%	67.3	3.879	14310	62.66	968
630-6/12T	C	S	NO	1.01	58.3%	62.2	4.250	14377	63.25	973
630-8T	C	S	NO	1.00	58.0%	66.3	1.629	10429	33.28	706

Best efficiency point data of the motor-impeller unit

Acoustic features

The specified values are determined according to free field measurements of pressure and sound levels in dB(A) at a distance of 6 m.

Sound power Lw(A) spectrum in dB(A) via frequency band in Hz.

Values taken at the inlet with 2/3 of the maximum airflow (2/3Qmax).

Model	63	125	250	500	1000	2000	4000	8000
200	35	41	52	55	56	52	50	44
225-4	42	51	56	56	60	59	52	46
225-6	31	40	45	45	49	48	41	35
250-4	46	55	60	60	64	63	56	50
250-6	34	43	48	48	52	51	44	38
315-4	50	56	62	62	65	68	59	53
315-6	39	45	51	51	54	57	48	42
315-8	35	41	47	47	50	53	44	38
400-4	57	63	69	69	72	75	66	60
400-6	46	52	58	58	61	64	55	49
400-8	42	48	54	54	57	60	51	45
450-4	62	69	74	74	78	77	70	65
450-6	50	57	62	62	66	65	58	53
450-8	46	53	58	58	62	61	54	49
450-12	35	42	47	47	51	50	43	38
500-6	54	60	65	66	70	69	62	55
500-8	47	53	58	59	63	62	55	48
500-12	39	45	50	51	55	54	47	40
560-6	57	63	68	69	73	72	65	58
560-8	49	55	60	61	65	64	57	50
560-12	42	48	53	54	58	57	50	43
630-6	61	67	72	73	77	76	69	62
630-8	53	59	64	65	69	68	61	54
630-12	46	52	57	58	62	61	54	47

Values taken at outlet with 2/3 of the maximum airflow (2/3Qmax).

Model	63	125	250	500	1000	2000	4000	8000
200	39	44	58	60	61	61	56	51
225-4	41	50	60	64	67	64	57	51
225-6	30	39	49	53	56	53	46	40
250-4	44	53	63	67	70	67	60	54
250-6	34	43	53	57	60	57	50	44
315-4	49	61	69	71	72	72	64	56
315-6	38	50	58	60	61	61	53	45
315-8	34	46	54	56	57	57	49	41
400-4	56	68	76	78	79	79	71	63
400-6	45	57	65	67	68	68	60	52
400-8	41	53	61	63	64	64	56	48
450-4	60	72	80	82	83	80	73	65
450-6	50	62	70	72	73	70	63	55
450-8	45	57	65	67	68	65	58	50
450-12	35	47	55	57	58	55	48	40
500-6	50	64	72	76	75	72	66	60
500-8	43	57	65	69	68	65	59	53
500-12	35	49	57	61	60	57	51	45
560-6	54	68	76	80	79	76	70	64
560-8	46	60	68	72	71	68	62	56
560-12	39	53	61	65	64	61	55	49
630-6	57	71	79	83	72	79	73	67
630-8	50	64	72	76	72	72	66	60
630-12	42	56	64	68	67	64	58	52

To obtain the Lwa sound power spectra in dB(A) at the inlet with the maximum airflow (Qmax), add the values in the following tables to the LpA sound pressure level given on the characteristic curves:

Frequency band in Hz								
63	125	250	500	1000	2000	4000	8000	
2	9	15	15	18	18	11	5	

Dimensions in mm

CHT

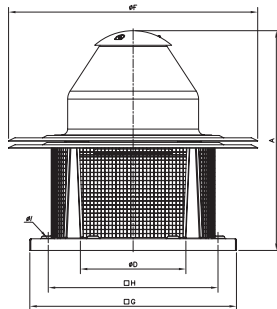

Model	A	øD*	øF	G	H	øI
CHT-200	552	250	570	450	360	12
CHT-225	570	250	570	450	360	12
CHT-250	632	355	726	560	450	12
CHT-315	682	355	726	560	450	12
CHT-400	755	500	856	710	590	12
CHT-450	770	500	856	710	590	12
CHT-500	846	630	1075	900	750	14
CHT-560	1035	710	1300	1100	900	14
CHT-630	1098	710	1300	1100	900	14

(*) Recommended nominal diameter for duct.

CVT

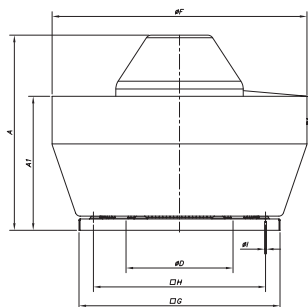

Model	A	A1	øD*	øF	G	H	øI
CVT-200	500	308	250	530	450	360	12
CVT-225	517	308	250	530	450	360	12
CVT-250	580	380	355	705	560	450	12
CVT-315	630	380	355	705	560	450	12
CVT-400	690	475	500	900	710	590	12
CVT-450	705	475	500	900	710	590	12
CVT-500	775	545	630	1100	900	750	14
CVT-560	956	676	710	1295	1100	900	14
CVT-630	1017	676	710	1295	1100	900	14

(*) Recommended nominal diameter for duct.

Accessories

See accessories section



Characteristic curves

Q = Airflow in m³/h, m³/s and cfm.

Pe = Static pressure in mmH₂O, Pa and inwg.

The Lp (dB(A)) sound levels given on the curves are free field pressure measurements at 6 metres at the inlet.

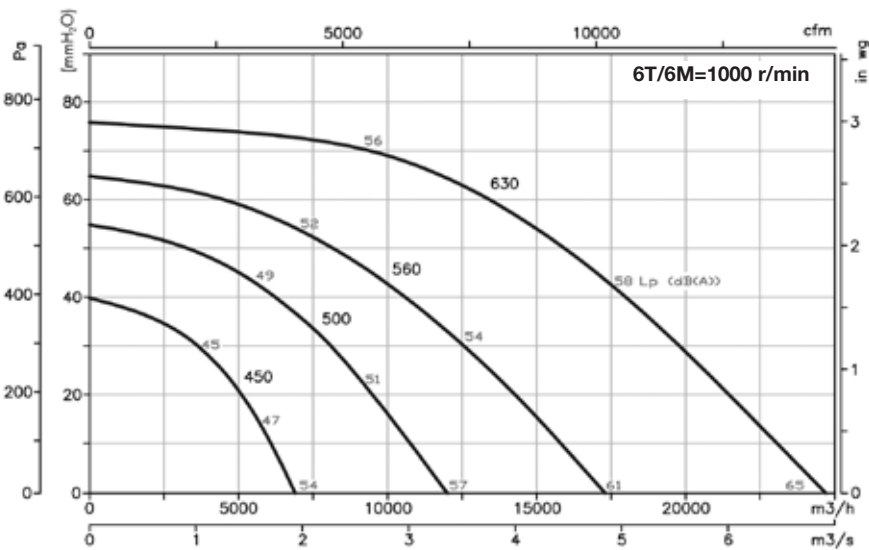
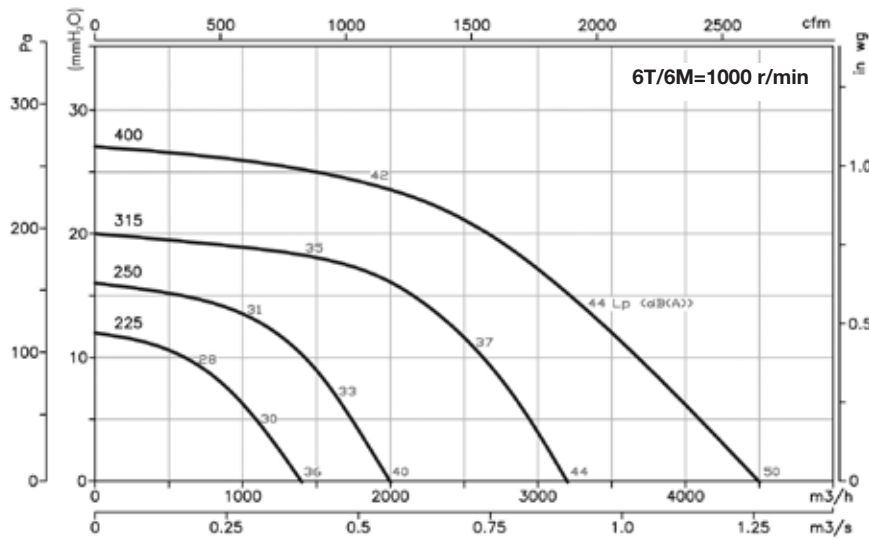
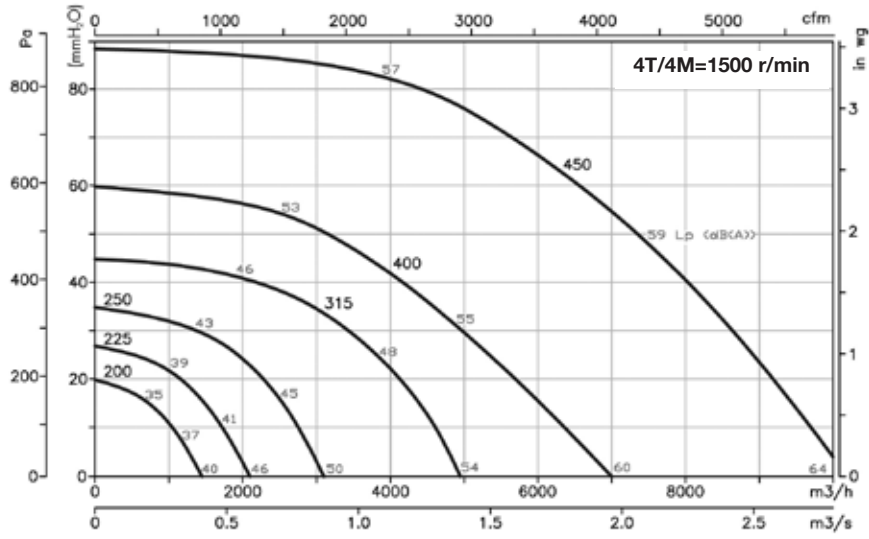

Characteristic curves

Q = Airflow in m³/h, m³/s and cfm. Pe= Static pressure in mmH₂O, Pa and inwg.
 The Lp (dB(A)) sound levels given on the curves are free field pressure measurements at 6 metres at the inlet.

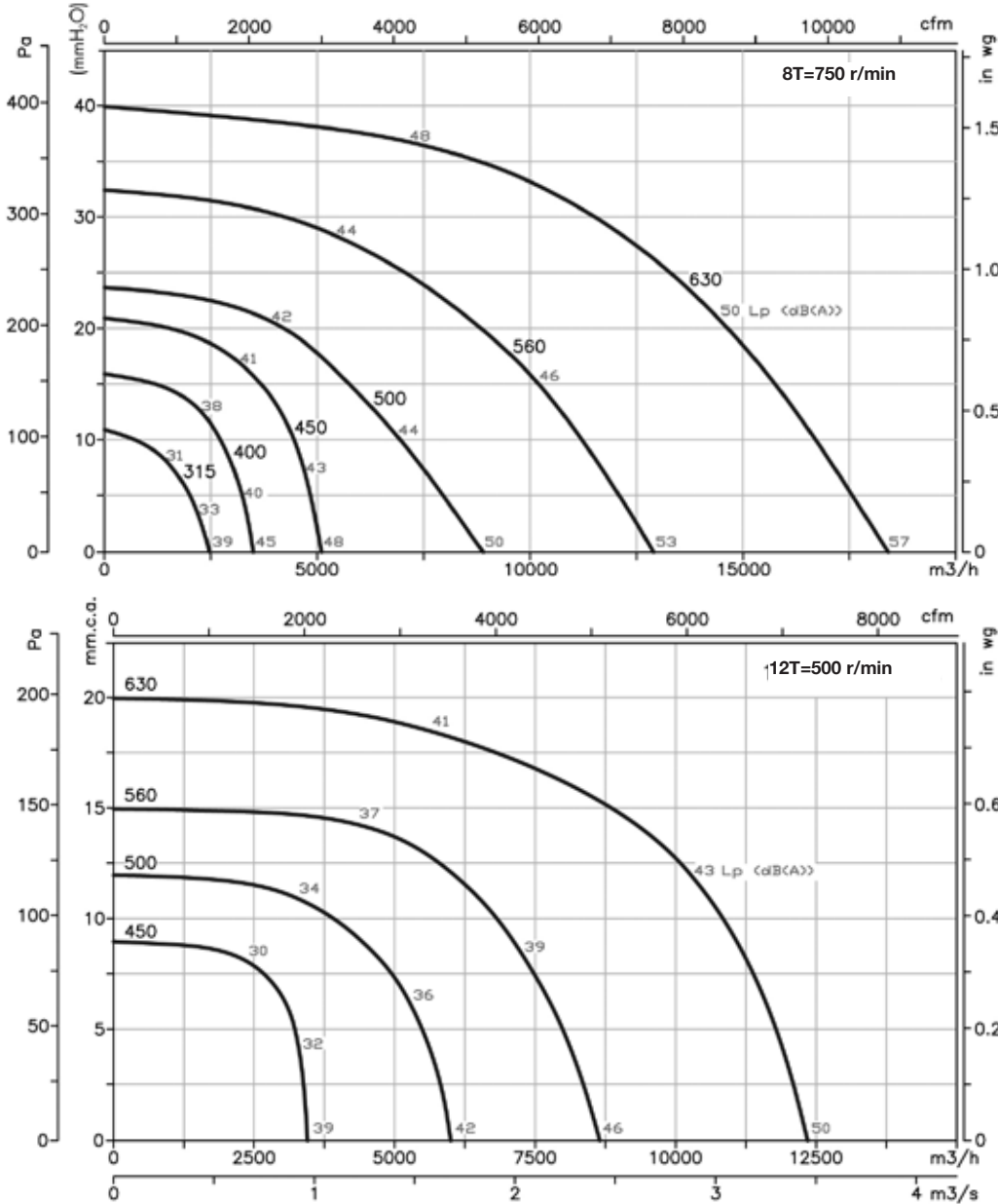

Variation of sound pressure depending on distance Example of use

The sound level may vary depending on the roof structure.

Fans suitable for use in industrial kitchens.
 For the correct application of the standard:

- Technical Building Code. Basic SI Document for fire safety. Basic HS Document for health and safety.

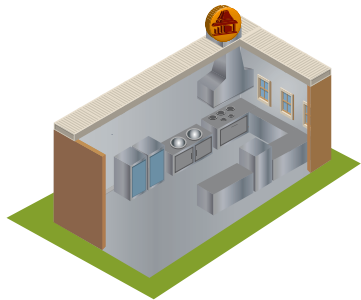
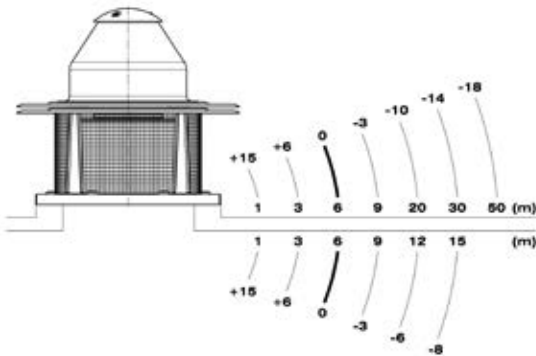

KIT SOBREPRESIÓN

The system of pressurisation of staircases, escape routes or of confinement makes it possible to control the airflow automatically and to maintain a differential pressure of 50 Pa in a single stage, according to standard UNE EN 12101-6-2006.

STAIRWELL KIT SOBREPRESIÓN
For three-phase equipment



STAIRWELL KIT SOBREPRESIÓN

- Stairwell overpressure kit made up of control panel (BOXPRES KIT) and outlet units (CJHCH or CJBD), for the pressurisation of the stairwells and escape routes. It also available for single-phase equipment NEOLINEO AND CJBC.

KIT SOBREPRESIÓN WITH RESERVE FAN

- Overpressure kit with reserve fan, made up of control panel (BOXPRES KIT II), which incorporates a system of automatic switching to keep the overpressure in the case of a stop by the main fan and TWIN or CJHCH/DUPLEX air outlet units with reserve fan.

STAIRWELL KIT SOBREPRESIÓN
For single-phase equipment



BOXPRES



- Easy to install
- Compact and self-sufficient solution
- Preventive maintenance
- Easy starting
- Safe and functional installation



- The proper operation of the pressurisation systems depends not only on correct design but also on the proper regulation carried out by the system with the result that it is of vital importance to have calibrated and highly-precise regulation elements which make it possible to have the two situations in the case of fire, in a rapid and stable manner.
- The BOXPRES control panel, apart from satisfying the most demanding requirements, simplifies the work of the installer to the greatest possible extent.

Includes:

- Frequency varier programmed to 50 Pa
- Differential pressure probe
- Magneto thermal
- Line LED and fault
- Check button

BOXPRES is a piece of equipment with all its interconnections made and tested

- Ready to work and carry out its duties on the pressure control of the installation.
- Possibility of checking the installation so as to prevent faults
- Only the power cable, the impulsion fan and the fire signal should be connected.

The panels for single-phase equipment include:

- Frequency voltage programmed to 50 Pa
- Differential pressure probe external to the equipment.

KIT SOBREPRESIÓN WITH
RESERVE FAN



Order code

KIT SOBREPRESIÓN — 7.100

Kit sobrepresión: Overpressure set for staircases
Kit sobrepresión II: Overpressure set with reserve fan

Maximum
Airflow

Technical characteristics

Model	Power supply	Output	Outlet unit	Airflow (m ³ /h)	Irradiated sound level * dB(A)
KIT SOBREPRESION-1060-LED	230 Vac II	230 Vac II	NEOLINEO-200	1060	38
KIT SOBREPRESION-2300-LED	230 Vac II	230 Vac II	NEOLINEO-315	2300	47
KIT SOBREPRESION-2880-LED	230 Vac II	230 Vac II	CJBC-2828-6M 1/3	2880	61
KIT SOBREPRESION-7100-LED	230 Vac II	230 Vac III	CJHCH-45-4T-0.5	7100	55
KIT SOBREPRESION-7800-LED	230 Vac II	230 Vac III	CJBD-3333-6T-1.5	7800	55
KIT SOBREPRESION-12900-LED	230 Vac II	230 Vac III	CJHCH-56-4T-1	12900	60
KIT SOBREPRESION-17000-LED	230 Vac II	230 Vac III	CJHCH-63-4T-1.5	17000	61
KIT SOBREPRESION-7100-BOX	400 Vac III	400 Vac III	CJHCH-45-4T-0.5	7100	55
KIT SOBREPRESION-7800-BOX	400 Vac III	400 Vac III	CJBD-3333-6T-1.5	7800	55
KIT SOBREPRESION-12900-BOX	400 Vac III	400 Vac III	CJHCH-56-4T-1	12900	60
KIT SOBREPRESION-17000-BOX	400 Vac III	400 Vac III	CJHCH-63-4T-1.5	17000	61
KIT SOBREPRESION II-6240-BOX	400 Vac III	400 Vac III	TWIN-12/12-6T-1.5	6240	55
KIT SOBREPRESION II-9520-BOX	400 Vac III	400 Vac III	TWIN-15/15-6T-3	9520	54
KIT SOBREPRESION II-12900-BOX	400 Vac III	400 Vac III	CJHCH/DUPLEX-56-4T-1-H	12900	60
KIT SOBREPRESION II-17000-BOX	400 Vac III	400 Vac III	CJHCH/DUPLEX-63-4T-1.5-H	17000	61
SONDA TPDA SI-PRESIÓN c/DISPLAY					
SONDA TPDA 984M.523 P04					
SONDA TPDA 984M.523 P14 LED					
BOXPRES KIT-3A 230Vac	230 Vac II	230 Vac II			
BOXPRES KIT-10A 230Vac	230 Vac II	230 Vac II			
BOXPRES KIT-0.75KW 230Vac	230 Vac II	230 Vac III			
BOXPRES KIT-1.5KW 230Vac	230 Vac II	230 Vac III			
BOXPRES KIT-0.75KW 400Vac	400 Vac III	400 Vac III			
BOXPRES KIT-1.5KW 400Vac	400 Vac III	400 Vac III			
BOXPRES KIT-2.2KW 400Vac	400 Vac III	400 Vac III			
BOXPRES KIT II - 1.5KW 400Vac	400 Vac III	400 Vac III			
BOXPRES KIT II - 2.2KW 400Vac	400 Vac III	400 Vac III			

Dimensions in mm

CJHCH

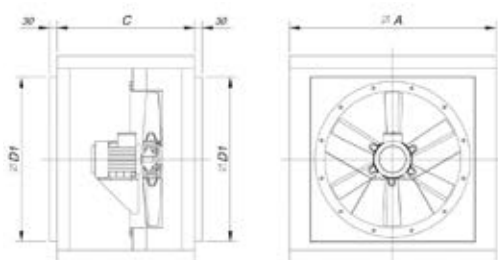

Model	ØA	C	ØD1
CJHCH-40/45/50	700	550	565
CJHCH-56/63	825	550	690

CJBD

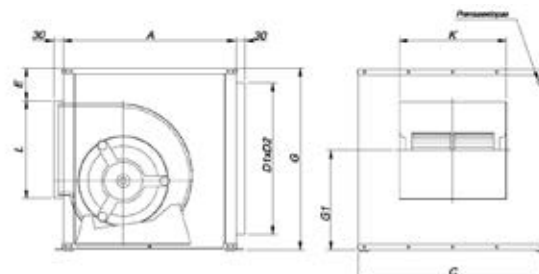

Model	Equiv. inches	A	B	C	E	D1xD2	G1	L	K
CJBD-3333	12/12	650	650	700	92	556X606	379	358	400

Dimensions in mm

TWIN

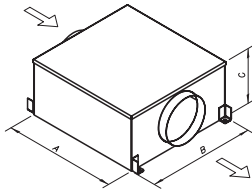

Model	A	B	C
TWIN-12/12	1103	1139	610
TWIN 15/15	1279	1639	698

CJHCH/DUPLEX

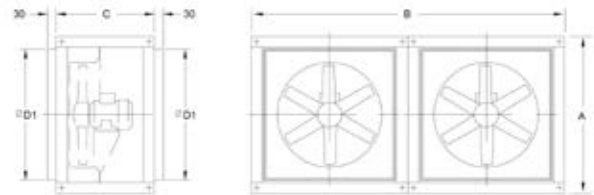

Model	ØA	B	C	ØD1
CJHCH/DUPLEX-56/63	825	1650	550	690

NEOLINEO

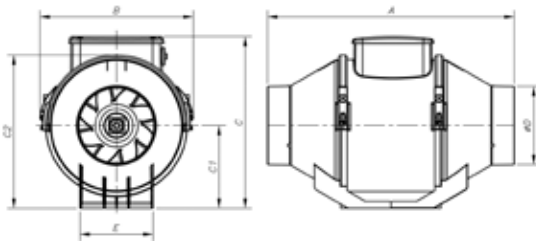

Model	A	B	C	C1	C2	ØD	E
NEOLINEO-200	300	234,5	260,5	125,5	235	196	140
NEOLINEO-315	448	361,5	392,5	188,5	359	312	220,5

CJBC

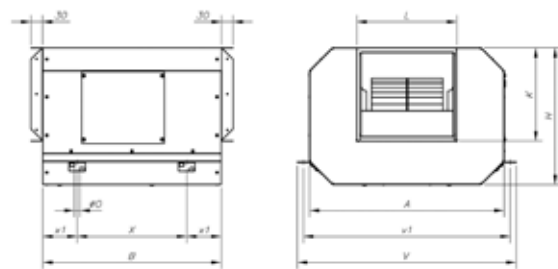

Model	A	B	H	K	L	ØO	V	v1	X	x1
CJBC-2828-6M-1/3	696	645	460	290	320	15	755	725	445	100

BOXPRESS KIT SOBREPRESIÓN

Technical characteristics and measurements

Model	Power kW	Power supply (V/Hz)	Output (V/Hz)	Output current (A)	Size	Measurements (L x W x D)
BOXPRES KIT-3A 230Vac	-	230 Vac II	230 Vac II	3	-	255 x 170 x 140 mm
BOXPRES KIT-10A 230Vac	-	230 Vac II	230 Vac II	10	-	255 x 170 x 140 mm
BOXPRES KIT-0.75kW 230Vac	0.75	230 V II / 50Hz	230 V III / 50Hz	4.3	1	270 x 270 x 170 mm
BOXPRES KIT-1.5kW 230Vac	1.5	230 V II / 50Hz	230 V III / 50Hz	7	1	270 x 270 x 170 mm
BOXPRES KIT-0.75KW 400Vac	0.75	400 V III / 50Hz	400 V III / 50Hz	2.2	1	270 x 270 x 170 mm
BOXPRES KIT-1.5KW 400Vac	1.5	400 V III / 50Hz	400 V III / 50Hz	4.1	1	270 x 270 x 170 mm
BOXPRES KIT-2.2KW 400Vac	2.2	400 V III / 50Hz	400 V III / 50Hz	5.8	2	360 x 360 x 205 mm

BOXPRES KIT-3A / KIT-10A

Connection of power and motor

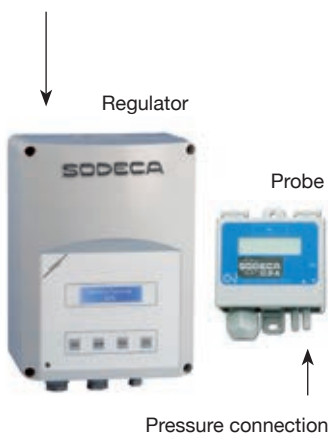

Stuffing-box for cable input to equipment Size 1

M 20 x 1.5mm
Connection of power and motor
M 12 x 1.5mm
Fire signal connection
Pressure connection



Stuffing-box for cable input to equipment Size 2

M 20 x 1.5mm
Connection of power and motor
M 12 x 1.5mm
Fire signal connection
Pressure connection



BOXPRES KIT SOBREPRESIÓN II

For equipment with reserve fan.

Technical characteristics and measurements

Model	Power kW	Power supply (V/Hz)	Output (V/Hz)	Output current (A)	Size	Measurements (L x W x D)	
BOXPRES KIT II - 1,5KW	400Vac	1,5	400 V III / 50Hz	400 V III / 50Hz	4,1	1	270 x 270 x 170 mm
BOXPRES KIT II - 2,2KW	400Vac	2,2	400 V III / 50Hz	400 V III / 50Hz	5,4	2	360 x 360 x 205 mm

* The two motors never operate simultaneously

Stuffing-box for cable input to equipment Size 1

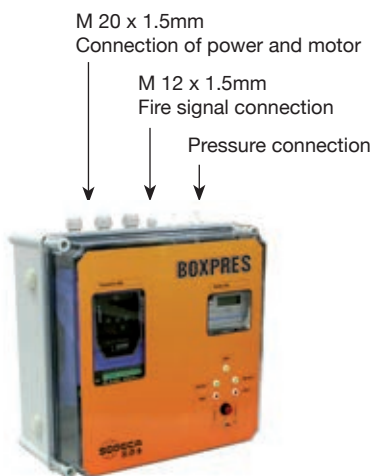

Stuffing-box for cable input to equipment Size 2



Example of use

Overpressure smoke control method; this system consists of pressurization by means of the injection of air in spaces which are used as escape routes for people in case of fire, such as stair wells, passageways, corridors, elevators, etc. Above all in densely occupied tall buildings. This method is based on smoke control by means of the speed of air and the artificial barrier which is created by excess air pressure over smoke, so that it cannot enter escape routes.

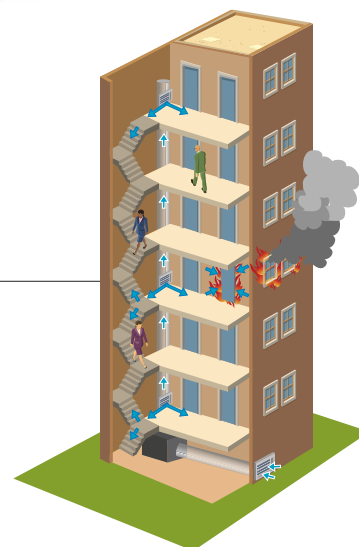

CENTRAL CO

Monoxide detection centres for control of ventilation in car parks



In order to fulfil Royal Decree 2367/1985 and the Technical Building Code

The Carbon Monoxide detection centres have been designed for application in underground car parks, tunnels or other locations where dangerous concentrations of CO might accumulate.

The system consists of the installation of a centre of 1 to 3 modules of areas with indicator display and each module permits connection of up to 32 detectors connected with two wires, with a maximum distance to the final detector of 2 kilometres

The detectors may be distributed over 2000 metres in length and each detector covers a maximum of 200m² of area as is defined in the current regulations

Through the optional FM-TC500 card it is possible to control a series RFM or RFT speed regulator, with the aim of reducing the energy consumption and the acoustic level of the extractors.

These systems involve a significant energy saving.

- System certified according to standard 23300/84
- Certification LOM 09MOGA3054.
- Modular and extensible centre
- Up to 19000 m² of management
- Versions of 1, 2, and 3 modules of areas
- Indication of the concentration per area
- 2 outlets of relays of extraction per area.
- 1 outlet of relay of alarm per area.
- Up to 32 detectors per area.
- Connection of the detectors to 2 wires.
- Mode of operation for low consumption.
- Option of Control by Speed Varier to reduce energy consumption and the sound level.
- Option of remote control of the system and integration with systems of energy analysis.

Model	Application
FMC-C-501	Centre for 1 area
FMC-C-502	Centre for 2 areas
FMC-C-503	Centre for 3 areas
FM-M-509	Module for extension of area
FM-DP500	CO wall detector
FM-D500	CO ceiling detector
FM-TC500	Control card per varier



CENTRES: Series FMC-C-501/502/503

- For 1, 2 or 3 areas depending on model
- Supplied voltage: 90 ~264VAC
- Power: 45 W
- Zone extension module FM-M-509

- Wiring of the area: 2 wires
- Maximum distance from the area line: 2 km. with 1.5 mm cable ²
- Number of detectors per area 32 detectors



CO Detector: Series FM-DP500/FM-D500

- Wall or ceiling mounted CO Detector according to model
- Technology: Electrochemical cell
- Useable lifetime 5 years
- Resolution: 1 ppm
- Reaction time: 10 seconds

- Storage temperature: -10°C to + 80°C
- Working area: 200m² limited by regulation
- IP Index from FM-D500: IP20
- IP Index from FM-DP500: IP54



Control card per varier. Series FM-TC500

- Module with PWM outlets which makes it possible to attack the extraction motors by means of speed regulators (energy saving).
- Communications module to carry out actions of tele-maintenance and tele-management.
- Open communications protocol for integration with other systems.

ACCESSORIES

INT



On/Off safety switches in accordance with Standard LINE-EN 60204-1.

194

IAT



On/Off safety switch for 200°C/2h and 400°C/2h

194

CABLE BOX



Electrical cable and connection box kit 400°C/2h

194

C2V



Switch for two-speed motors.

194

RM



Electronic speed controllers

194

AR



Soft starters for three-phase motors.

195

RFT RFM



Frequency converters for 400V three-phase motors.

195

ELECTRICAL PANELS



Electrical panels

196

PL P P-400



Backdraught louvres, certified for 400°C/2h.

197

R/THT



Protection guard for inlet of axial fans.

198

RT



Protection guard for inlet or outlet of long-cased axial fans.

198

RPA



Protection guard for inlet of centrifugal fans.

198

B



Coupling flange for centrifugal fans.

199

BTUB



Coupling flange for axial fans.

199

BD



Double, elastic coupling flange for centrifugal fans.

199

BAC



Double, elastic coupling flange for axial fans.

200

BIC



Flange to change from rectangular to circular for centrifugal fans.

200

PS



Support stands for long-cased fans

200

MS



Support frame to allow mounting on-site.

200

PA



Adaptation plate to mount accessories on roof fans.

200

PT



Automatic-closing shutters to work in vertical position

201

ACE-400



400°C/2h elastic coupling to absorb vibrations.

201

REG



Record of regulation manual

201

VIS



Outlet hood with protection guard.

201

TEJ



Outside covers.

202

CM

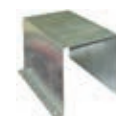

Motor cover for outside work.

202

TAC



Circular coupling plate.

202

S



Silencers to fit to inlet or outlet.

202

CENTRAL CO



CO detection centres

192

KITS SOBREPRESIÓN



188



INT

On/off safety switches in accordance with Standard UNE-EN 60204-1.

Features:

- Switches to install beside the fan, so that the mains current can be cut off before handling the fan.
- IP65 protection
- For three-phase or two-speed fans, use 6-pole switch
- For single-phase fans, use a 3-pole switch

Model	Current (A)	(kW)	Cable input (mm)	Model	Current (A)	(kW)	Cable input (mm)
INT-CA 10/3CA	20	5.5	19	INT-CA 10/6CA	20	5.5	19
INT-KG 10/3CA	20	5.5	23	INT-KG 10/6CA	20	5.5	23
INT-KG 20/3CA	25	7.5	29	INT-KG 20/6CA	25	7.5	29
INT-KG 32/3CA	32	11	29	INT-KG 32/6CA	32	11	29
INT-KG 41/3CA	40	15	37.5	INT-KG 41/6CA	40	15	37.5
INT-KG 64/3CA	63	22	37.5	INT-KG 64/6CA	63	22	37.5
INT-KG 80/3CA	80	30	37.5	INT-KG 80/6CA	80	30	37.5
INT-KG 100/3CA	100	37	37.5	INT-KG 100/6CA	100	37	37.5



IAT

On/off safety switches for 400°C/2h and 200°C/2h in accordance with Standard UNE-EN 60204-1.

Features:

- 400°C/2h and 200°C/2h switches to be placed beside the fan, so that the mains current can be cut off before handling the fan.
- Protection IP-65 model 400°C/2h and IP-55 model 200°C/2h

Model	Current (A)	Model	Current (A)
IAT-400-20/3P	20	IAT-400-63/6P	63
IAT-400-32/3P	32	IAT-400-125/6P	125
IAT-400-63/3P	63	IAT-200/16	16
IAT-400-125/3P	125	IAT-200/32	32
IAT-400-20/6P	20	IAT-200/63	63
IAT-400-32/6P	32		



CABLE BOX

Electrical cable and connection box kit 400°C/2h for external connections to the motor in fire-fighting installations

Features:

- Electrical six-wire cable and ground connection, with length of 1.5m and terminals at each end
- Cast aluminium terminal board
- Terminal Strip in ceramic material

- Kit certified jointly with the CJBTD extractor series, with certification Number 0370-CPD-0580

Model	Maximum power motor 3x400V (kW)
CABLE BOX-1-400	5.5
CABLE BOX-2-400	15.0



C2V

Switch for two-speed motors

Features:

- 1-0-2 three-position switch to operate two-speed motors with Dahlander connection
- IP67 protection

Model	Current (A)	(kW)	Cable input (mm)
C2V-CG10 A441	20	5.5	20

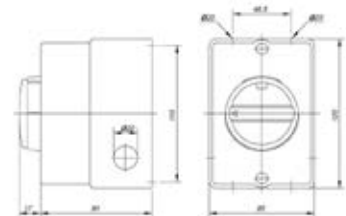

RM

Features:

- Electronic speed controllers especially designed for fans with single-phase motors, in accordance with standard EN-60335
- Models RM-1, RM-2 and RM-3, IP54 protection. Models RM-00, RM-01 and RM-02, IP44 protection
- In accordance with Electromagnetic Compatibility Directives 92/31/EEC and 93/68/EEC and in accordance with Low Voltage Directive 73/23/EEC

- On/off switch.
- Minimum speed adjustment
- With EMC filters in accordance with standard EN-55014

Model	Input voltage	Protection	Maximum current (A)
RM-00	230 V-50/60 Hz	IP-44	0.5
RM-01	230 V-50/60 Hz	IP-44	1
RM-02	230 V-50/60 Hz	IP-44	2
RM-1	230 V-50/60 Hz	IP-54	3
RM-2	230 V-50/60 Hz	IP-54	5
RM-3	230 V-50/60 Hz	IP-54	10

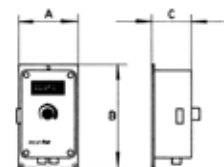

Model	A	B	C
RM-00	81	81	66
RM-01	81	81	66
RM-02	81	81	66
RM-1	80	145	80
RM-2	96	164	85
RM-3	96	164	85



AR

Soft starters for three-phase motors.

Features:

- Especially designed to reduce the current peak caused during start-up of fans with three-phase motors.
- Power Voltage 400V + - 10% 50/60Hz
- Mounted in box for DIN-35 rail
- Possibility of adjusting the starting torque, acceleration time and deceleration time.

Model	AR-2	AR-4	AR-7.5	AR-10	AR-15	AR-20	AR-30
Supplied voltage	400 V ±10% 50/60 Hz						
Motor power in kW at 400 V	1.5	3	5.5	7.5	11	15	22
Minimum motor power	40% of the motor's nominal power			20% of the motor's nominal power			
External fuses (quick-action) in (A)	16	25	35	25	35/40	50	63
Nominal current in (A)	3.5	6,5	12	17	25	32	45
Adjustment range of start-up torque	From 0 to 80%						
Adjustment range of start-up time	From 0.5 to 12 s			From 0.5 to 10 s			
Braking torque	Level set at 70%						
Adjustment range of deceleration time	From 0.5 to 12 s			From 0.5 to 10 s			
Setup time	200 ms						
Working temperature	0°C....45°C						
Storage temperature	-25°C....75°C						
Protection level	IP20						
Environmental conditions	Overpressure category III, Pollution level 2						
Power reduced with max. temperature	1% for every 1°C increase in the maximum temperature						
Maximum height for mounting	Up to 1000 m						
Power reduced with max. height	0.5% for every 100 m over 1000 m.						
Humidity	93% maximum without condensation						
Maximum cycles per hour (3 x I nom, 10 sec)	90/h	60/h	30/h	60/h	40/h	30/h	20/h
Weight in kg	0.4			1.0			
Measurements	Width (W) mm	45			45		52.5
	Height (H) mm	73			173		178
	Depth (D) mm	122			152		158
Installation	Fixing A x B			On DIN guide rail			



RFT

RFM

Frequency converter for 400V three-phase motors.

Features:

- The RFT converter series are suitable to vary the speed, via voltage and frequency, of axial and centrifugal fans with 400V three-phase motors. Converter power supply: 400V three-phase. 50/60 Hz.
- In accordance with Electromagnetic Compatibility Directives 92/31/EEC and 93/68/EEC and in accordance with Low Voltage Directive 73/23/EEC

Features:

- The RFM converter series are suitable to vary the speed, via voltage and frequency, of axial and centrifugal fans with 230V three-phase motors. Converter power supply: 230V single-phase. 50/60 Hz.
- In accordance with Electromagnetic Compatibility Directives 92/31/EEC and 93/68/EEC and in accordance with Low Voltage Directive 73/23/EEC

Model	RFT-0.5	RFT-1	RFT-2	RFT-3	RFT-5.5	RFT-7.5	RFT-10	RFT-15	RFT-20	RFT-25	RFT-30
Motor (CV)	0.5	1	2	3	5.5	7.5	10	15	20	25	30
(kW)	0.37	0.75	1.5	2.2	4	5.5	7.5	11	15	18.5	22
Current (A)	1.25	2.5	4	6	9	12	16	24	30	39	45
kVA	0.95	1.9	3	4.5	6.9	9.1	12.2	19.1	23.9	31.1	35.9
Inlet	Three-phase										
Voltage (V)	3 x 380...480 V (-15% +10%)										
Frequency (Hz)	50 - 60 Hz (± 5%)										
Outlet	Three-phase										
Voltage (V)	3 x 380...480 V										
Frequency (Hz)	0....400 Hz						0...120 Hz				
Braking torque	20% (with external resistance: 100%, 150%)										
Braking unit	Incorporated in the equipment							Optional			
Size Width (W1) mm	70	70	100	140	140	180	180	200	250	250	304
Height (H1) mm	128	128	128	128	128	220	220	284	385	385	460
Depth (D1) mm	130	130	130	155	155	170	170	182	201	201	234
Weight (Kg)	0.76	0.77	1.12	1.84	1.89	3.66	3.66	6	12.5	13	20
Method of refrigeration	Forced air										

Model		RFM-0.5	RFM-1	RFM-2	RFM-3
Motor	(CV)	0.5	1	2	3
	(kW)	0.37	0.75	1.5	2.2
Current	(A)	2.5	2.5	4	6
kVA		0.95	1.9	3	4.5
Input		Single-phase			
Voltage	(V)	2 x 200 ÷ 230 V (±10%)			
Frequency	(Hz)	50 – 60 Hz (± 5%)			
Output		Three-phase			

Model		RFM-0.5	RFM-1	RFM-2	RFM-3
Voltage	(V)	3 x 200 ÷ 230 V			
Frequency	(Hz)	0 ÷ 400 Hz			
RFI Filter		Built in			
Size Width	(W1) mm	79	79	156	156
Height	(H1) mm	143	143	143	143
Depth	(D1) mm	143	143	143	143
Weight	(Kg)	0.95	0.97	1.94	2.00
Method of refrigeration		Forced air			

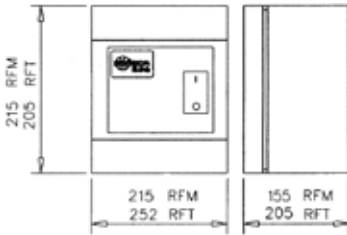

1. In general, all SODECA fans with a three-phase motor under normal operating conditions are suitable for working supplied with a static frequency converter (in accordance with IEC 60034-17). Nevertheless, some motors require special measures.

The maximum operating frequency or speed must never exceed that for which the fan has been designed. In applications with quadratic torques such as fans and pumps, when the speed varies the absorbed power is directly proportional to the cube of the rotating speed: $P_{a_2} = P_{a_1} (n_2 / n_1)^3$

2. The insulation of motors coupled to fans is sufficient to work without restrictions with a frequency converter up to voltages of < 500 V. The use of sinusoidal filters at the converter output will help the motor to operate properly, reducing breakdowns and increasing the fan's service life.

It is recommended that, for motors of sizes > 225, they be ordered with special windings to work with a frequency converter.

3. The length of the wires running from the converter to the fan have a particular influence on voltage characteristics at the motor terminals. The definition of "long wires" will depend on the nominal value and the converter type. The manufacturer's technical documentation must be consulted.

4. EEx-d flame-resistant motors must be ordered for operation using a frequency converter. The motor manufacturer will request information about the application via a questionnaire in order to establish the working parameters. These motors must also be fitted with PTC probes.

5. EEx-e increased safety motors cannot be operated with a frequency converter (a joint motor-converter certification would be required for this).



KME - 10K

External control kit for On/Off and velocity control for RFM and RFT frequency converters

Features:

- On/Off by button
- Display by means of LED of the position of On or Off
- Memory of the latest position for speed regulation

- Possibility of installation on the surface or built-in



GMP

Electrical starter panel and protection of fans with three-phase motor, with On/Off buttons

Features:

- On/Off by button
- Incorporates fully-cabled contactor and adjustable thermal relay for protection of the motor
- The Off button is used to reset the thermal relay, in case it should go off due to overload
- For assembly on the surface, IP-55 protection

For fan with three-phase motor 230V

Model	Current of regulation (A)	Power motor 3x230V (kW)
GMP-0,2-0,33/230	1.2-1.8	0.25
GMP-02-0,75/230	1.8-2.8	0.37 / 0.55
GMP-02-1/230	2.8-4	0.75
GMP-02-1,5/230	4-6.3	1.10
GMP-02-2/230	5.6-8	1.50
GMP-04-3/230	7-10	2.20
GMP-04-4/230	8-12.5	3.00
GMP-04-5,5/230	11-17	4.00
GMP-04-7,5/230	15-23	5.50
GMP-04-10/230	22-32	7.50
GMP-06-12,5/230	25-40	9.20
GMP-06-15/230	25-40	11.00

For fan with three-phase motor 400V

Model	Current of regulation (A)	Power motor 3x400V (kW)
GMP-0,2-0,33/400	0.56-0.8	0.25
GMP-02-0,5/400	0.8-1.2	0.37
GMP-02-0,75/400	1.2-1.8	0.55
GMP-02-1,5/400	1.8-2.8	1.10
GMP-02-2/400	2.8-4	1.50
GMP-02-3/400	4-3	2.20
GMP-02-4/400	5.6-8	3.00
GMP-04-5,5/400	7-10	4.00
GMP-04-7,5/400	8-12.5	5.50
GMP-04-10/400	11-17	7.50
GMP-06-12,5/400	15-23	9.20
GMP-06-15/400	15-23	11.00
GMP-06-20/400	22-32	15.00
GMP-06-25/400	25-40	18.50



GMM Electrical starter panel and protection from overload and short-circuits of fans with three-phase motor, with rotary controls

Features:

- On/Off by means of a rotary control with the possibility of blocking with three locks
- Incorporates adjustable thermal relay for protection from overload and short-circuit
- For assembly on the surface, IP-55 protection

For fan with three-phase motor 400V

Model	Current of regulation (A)	Power motor 3x400V (kW)
GMM-01-1/400	1.6-2.5	0.75
GMM-01-2/400	2.5-4	1.10 1.50
GMM-01-3/400	4-6.3	2.20
GMM-01-5,5/400	6.3-10	3.00 4.00
GMM-01-7,5/400	10-16	5.50
GMM-01-10/400	16-20	7.50
GMM-01-15/400	20-25	11.00
GMM-01-20/400	25-32	15.00



AET Electrical starter panel, star / triangle, and protection of fans with three-phase motor, with On/Off buttons

Features:

- On/Off by button
- Display of condition by means of luminous pilot lights
- Incorporates adjustable thermal relay for protection of the motor

- Fully cabled
- Metal box for assembly on the surface, IP-65 protection

For fan with three-phase motor 230V/400V. Power supply 3x230V

Model	Current regulation of thermal relay (A)	Power motor 3x230/400V (kW)
AET-01-3/230	4-6.3	2.2
AET-01-4/230	5-8	3.0
AET-01-5,5/230	7-10	4.0
AET-01-7,5/230	12-18	5.5
AET-01-10/230	12-18	7.5
AET-01-15/230	18-26	11.0
AET-01-20/230	24-36	15.0
AET-01-25/230	28-40	18.5
AET-02-30/230	34-50	22.0
AET-02-40/230	45-65	30.0
AET-02-50/230	63-85	37.0

For fan with three-phase motor 400V/690V. Power 3x400V+N

Model	Current regulation of thermal relay (A)	Power motor 3x400/690V (kW)
AET-01-5,5/400	4-6,3	4
AET-01-7,5/400	5-8	5,5
AET-01-10/400	7-10	7,5
AET-01-15/400	12-18	11
AET-01-20/400	12-18	15
AET-02-30/400	18-26	18,5/22,0
AET-02-40/400	28-40	30
AET-02-50/400	34-50	37
AET-02-60/400	45-65	45
AET-02-75/400	45-65	55



AD Electrical starter panel and protection of fans with three-phase motor, with two DAHLANDER speeds

Features:

- Switch for selecting speed (1-0-2), Low-Off-High.
- Display of condition by means of luminous pilot lights
- Incorporates adjustable thermal relay for protection of the motor
- Fully cabled
- Metal plate for assembly on the surface, IP-65 protection

For fan with three-phase 400V Dahlander motor. Power 3x400V+N

Model	Current regulation of thermal relay	
	High speed (A)	Low speed (A)
AD-01-2,5-1/400	1,6-2,5	0,63-1
AD-01-4-1,6/400	2,5-4	1-1,6
AD-01-4-2,5/400	2,5-4	1,6-2,5
AD-01-6-2,5/400	4-6	1,6-2,5
AD-01-9-2,5/400	6-9	1,6-2,5
AD-01-9-4/400	6-9	2,5-4
AD-02-13-4/400	9-13	2,5-4
AD-02-18-6/400	12-18	4-6
AD-02-18-9/400	12-18	6-9
AD-02-26-9/400	18-26	6-9
AD-02-36-9/400	24-36	6-9
AD-02-36-13/400	24-36	9-13
AD-02-40-18/400	28-40	12-18



PL Plastic backdraught louvres.

Features:

- The backdraught louvre is adapted directly to the wall where the fan is mounted.
- Opening through overpressure due to airflow
- Closed when the fan is on standby
- Made from plastic
- Maximum recommended speed 12m/sec for models 80, 90 and 100

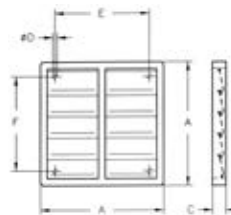

Model	Measurements				
	A	C	ØD	E	F
PL-20	240	28	5.2	193	167
PL-25	294	26	5	232	232
PL-31	347	26	5	276	276
PL-35	397	26	5	310	310
PL-40	459	26	5	364	364
PL-45	501	26	5	395	395
PL-50	549	31	5	445	445
PL-56	605	28	5	522	522
PL-63	696	31	5	626	626
PL-71	760	40	5	692	692
PL-80	840	40	5	772	772
PL-90	940	40	5	872	87
PL-100	1040	40	5	972	972



P Aluminium backdraught louver

Features:

- The backdraught louver is adapted directly to the wall where the fan is mounted.
- Opening through excess pressure due to airflow
- Closed when the fan is on standby
- Aluminium sheet construction
- Maximum recommended speed 18m/sec for models 90 and 100

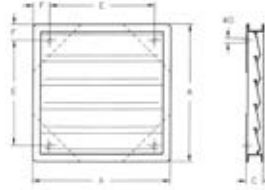

Model	Measurements				
	A	C	ØD	E	F
P-25	290	51	6	187	51.5
P-35	400	81	6	266	67
P-45	500	51	6	347	76.5
P-56	600	51	6	447	76.5
P-63	715	72	6	535	90
P-71	780	72	6	605	87.5
P-80	875	72	6	675	100
P-90	970	72	6	755	107.5
P-100	1070	72	6	850	110



P-400 Backdraught louver, certified for 400°C/2h.



Features:

- Supplied mounted in the box with appropriate adapter
- Standardisation in accordance with standard EN-12101-3- 2002, certificate no.: 0370-CPD-0312
- Frame made from sheet steel and slats from aluminium sheet.
- Can be used for other 400°C/2h applications

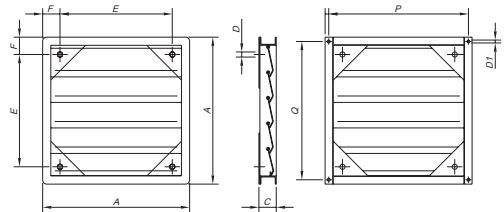

Model	A	C	ØD	E	F	P	Q	D1
P-400-56	645	51	6	492	76.5	595	595	10
P-400-63	760	72	6	580	90	720	720	10
P-400-80	915	72	6	715	100	880	880	10
P-400-100	1115	72	6	895	100	1080	1080	10



R/THT Protection guard for inlet of axial fans.

Features:

- Protects against contact with the impeller and prevents objects from entering, in accordance with standard UNE-100250
- Manufactured with electro-soldered wire

Model	Applies to models
R-THT-40	THT-40
R-THT-45	THT-45
R-THT-50	THT-50
R-THT-56	THT-56 (Motors size 80/90)
R-THT-56-1	THT-56 (Motors size 100/112)
R-THT-63	THT-63 (Motors size 80/90)
R-THT-63-1	THT-63 (Motors size 100/112)
R-THT-63-2	THT-63 (Motors size 132)
R-THT-63-3	THT-63 (Motors size 160)
R-THT-71	THT-71 (Motors size 80/90)
R-THT-71-1	THT-71 (Motors size 100/112)
R-THT-80	THT-80 (Motors size 90/100)
R-THT-80-1	THT-80 (Motors size 112)
R-THT-80-2	THT-80 (Motors size 132)
R-THT-90	THT-90 (Motors size 90)
R-THT-90-1	THT-90 (Motors size 100/112)
R-THT-90-2	THT-90 (Motors size 132)

Model	Applies to models
R-THT-90-3	THT-90 (Motors size 160)
R-THT-100	THT-100 (Motors size 112)
R-THT-100-1	THT-100 (Motors size 132)
R-THT-100-2	THT-100 (Motors size 160)
R-THT-125	THT-125 (Motors size 132)
R-THT-125-1	THT-125 (Motors size 160)
R-THT-125-2	THT-125 (Motors size 180)
R-THT-125-3	THT-125 (Motors size 200)
R-THT-125-4	THT-125 (Motors size 225/250)
R-THT-140	THT-140 (Motors size 132/180)
R-THT-140-1	THT-140 (Motors size 160/200)
R-THT-140-2	THT-140 (Motors size .225/250)
R-THT-160	THT-160 (Motors size 132/180)
R-THT-160-1	THT-160 (Motors size 160/200)
R-THT-160-2	THT-160 (Motors size .225/250)
R-THT-160-3	THT-160 (Motors size 280)

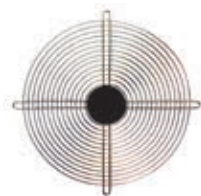

RT Protection guard for inlet or outlet of long-cased axial fans.

Features:

- Protects against contact with the impeller and prevents objects from entering, in accordance with standard UNE-100250
- Manufactured with electro-soldered wire

Applies to models		Applies to models	
Model	THT	Model	THT
RT-25	-	RT-63	63
RT-31/B	-	RT-71	71
RT-31	-	RT-80	80
RT-35	-	RT-90	90
RT-40	40	RT-100	100
RT-45	45	RT-125	125
RT-50	50	RT-125/CC	125
RT-56	56		



RPA Protection guard for inlet of centrifugal fans.

Features:

- Protects against contact with the impeller and prevents objects from entering, in accordance with standard UNE-100250
- Made from sheet steel.

Applies to models			Applies to models		
Model	CTMP TCMP	TCR TCR/R	Model	CTMP TCMP	TCR TCR/R
RPA-25	820	-	RPA-47	1640	1240
RPA-28	922	-	RPA-52	1845	1445
RPA-31	1025	-	RPA-60	2050	1650
RPA-35	1128	-	RPA-66	-	1856
RPA-38	1231	-	RPA-73	-	2063
RPA-42	1435	-	RPA-81	-	2271



B Coupling flange for centrifugal fans.

- Features:
- Adapted to inlet and outlet.
 - Aids installation on duct

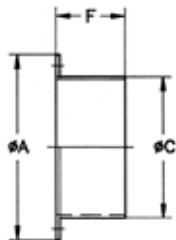

Model	A	C	F	Model	A	C	F	Model	A	C	F	Model	A	C	F
B-52-E	100	52	67	B-224	280	224	60	B-355/2	430	355	80	B-500/5	590	500	80
B-63	110	63	60	B-250/1	310	250	80	B-355/3	430	355	80	B-560/1	650	560	80
B-80	150	80	60	B-250/2	310	250	80	B-355/4	430	355	80	B-560/2	650	560	80
B-80-E	150	80	60	B-250/3	310	250	80	B-400/1	480	400	80	B-560/3	650	560	80
B-100	150	100	60	B-250/4	310	250	80	B-400/2	480	400	80	B-630/1	720	630	80
B-100-E	170	100	60	B-250/5	310	250	80	B-400/3	480	400	80	B-630/2	720	630	80
B-112	160	112	60	B-280/1	350	280	80	B-400/4	480	400	80	B-630/3	720	630	80
B-125	180	125	60	B-280/2	350	280	80	B-450/1	530	450	80	B-630/4	720	630	80
B-140	190	140	60	B-280/3	350	280	80	B-450/2	530	450	80	B-710/1	800	710	80
B-150	210	150	60	B-315/1	350	315	80	B-450/3	530	450	80	B-710/2	800	710	80
B-160	220	160	60	B-315/2	380	315	80	B-500/1	590	500	80	B-710/3	800	710	80
B-160/1	220	160	60	B-315/3	380	315	80	B-500/2	590	500	80	B-800	890	800	100
B-180	240	180	60	B-315/4	380	315	80	B-500/3	590	500	80	B-900/1	1000	900	100
B-200	260	200	60	B-355/1	430	355	80	B-500/4	590	500	80	B-1000/1	1100	1000	100

Applies to models

	CVT CHT	CTMP TCMP	TCR TCR/R
B-112	-	512	-
B-140	-	514	-
B-160	-	616	-
B-180	-	718	-
B-200	-	620/820	-
B-224	-	922	-
B-250/3	200/225	1025	-

Applies to models

	CVT CHT	CTMP TCMP	TCR TCR/R
B-280/2	-	1128	-
B-315/3	-	-	1031
B-315/4	-	1231	-
B-355/1	-	-	1135
B-355/3	250/315	1435	-
B-400/1	-	1640	-
B-400/2	-	-	1240

Applies to models

	CVT CHT	CTMP TCMP	TCR TCR/R
B-450/1	-	1845	-
B-450/2	-	-	1445
B-500/1	-	2050	-
B-500/2	-	-	1650
B-500/4	400/450	-	-
B-560/2	-	-	1856
B-630/2	-	-	2063

Applies to models

	CVT CHT	CTMP TCMP	TCR TCR/R
B-630/3	500	2563	-
B-710/1	-	-	2271
B-710/2	560/630	-	-
B-800	-	-	2380
B-900/1	-	-	2590
B-1000/1	-	-	28100



BTUB

Coupling flange for axial fans

- Features:
- Adapted to inlet and outlet.
 - Aids installation on duct

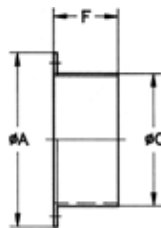

	C	A	F		C	A	F
BTUB-250	250	310	80	BTUB-630	630	720	80
BTUB-280	280	350	80	BTUB-710	710	800	80
BTUB-315	315	380	80	BTUB-800	800	890	100
BTUB-355	355	430	80	BTUB-900	900	1000	100
BTUB-400	400	480	80	BTUB-1000	1000	1100	100
BTUB-450	450	530	80	BTUB-1250	1250	1365	100
BTUB-500	500	590	80	BTUB-1400	1400	1520	100
BTUB-560	560	650	80	BTUB-1600	1600	1720	100



BD

Dual coupling flange for centrifugal fans.

- Features:
- Adapted to the inlet
 - Aids installation on duct with flange

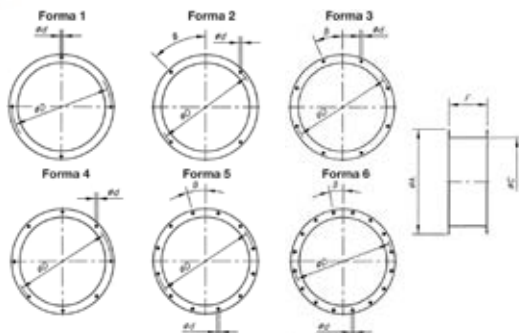

	$\varnothing A$	$\varnothing C$	$\varnothing D$	$\varnothing d$	F	β	Form	CTMP TCMP	TCR TCR/R
BD-200	260	200	225	7	80	15°	2	820	
BD-224	280	224	254	7	80	-	1	922	
BD-250/1	310	250	280	10	80	45°	2	1025	
BD-280	350	280	320	10	100	-	4	1128	
BD-315/3	390	315	355	10	100	22°30'	3	1231	
BD-355/3	430	355	395	10	100	22°30'	3	1435	
BD-400/1	480	400	450	12	100	22°30'	3	1640	
BD-400/2	480	400	450	12	100	22°30'	3		1240
BD-450/1	530	450	500	12	100	22°30'	3	2050	
BD-450/2	530	450	500	12	100	22°30'	3		1445
BD-500/2	590	500	560	12	100	15°	5		1650
BD-560	650	560	620	12	120	15°	5		1856
BD-630/2	720	630	690	12	120	15°	5		2063
BD-710	800	710	770	12	120	11°15'	6		2271



BAC

Double, elastic coupling flange for axial fans

Features:

- Adapted to inlet and outlet
- Aids installation on duct with flange
- Prevents transmission of vibrations

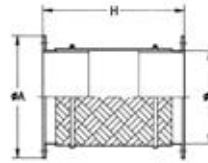

	ØD*	ØA*	H	CVT/CHT	THT
BAC-250	250	310	340	200/225	-
BAC-355	355	430	340	250/315	-
BAC-400	400	480	340	-	40
BAC-450	450	530	340	-	45
BAC-500	500	590	340	400/450	50
BAC-560	560	650	340	-	56
BAC-630	630	720	340	500	63
BAC-710	710	800	340	560/630	71
BAC-800	800	890	340	-	80
BAC-900	900	1000	340	-	90
BAC-1000	1000	1100	340	-	100
BAC-1250	1250	1365	340	-	125

*Nominal diameter for pipe.

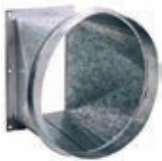

BIC

Flange conversion from rectangular to circular for centrifugal fans.

Features:

- Adapted to the outlet
- Aids installation on circular duct

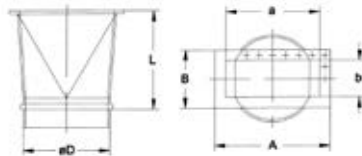

	L	D	a	b	A	B	Applies to models
BIC-820	300	200	160	130	213	184	TCMP-820
BIC-922	300	224	216	140	282	204	CTMP/TCMP-922
BIC-1025	300	250	250	165	314	229	CTMP/TCMP-1025
BIC-1128	300	280	300	180	364	244	CTMP/TCMP-1128
BIC-1231	300	315	320	200	384	266	CTMP/TCMP-1231
BIC-1435	300	355	280	228	344	294	CTMP/TCMP-1435
BIC-1640	300	400	320	250	404	336	CTMP/TCMP-1640
BIC-1845	450	450	360	284	444	370	CTMP/TCMP-1845
BIC-2050	450	500	450	315	545	412	CTMP/TCMP-2050
BIC-2563	450	630	600	410	706	512	TCMP-2563



PS

Support stands for long-cased fans.

Features:

- When fixed to the flange, it allows the fan to be fixed to flat surfaces.

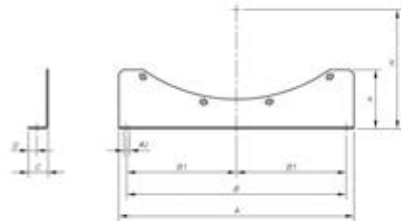

Model	A	B	B1	C	D	h	H	ØJ	Applies to the models					
									HEPT	HCT	HGT	HPX	THT	
PS-25/31	275	225	-	25	10,5	90	165	10	-	25	-	-	-	-
	275	225	-	25	10,5	90	191,5	10	-	31	-	-	-	-
	275	225	-	25	10,5	90	205	10	31	-	-	-	-	-
PS-35/40	240	200	-	30	13	60	230	10	35	35	-	35	-	-
	240	200	-	30	13	60	255,5	10	40	40	-	-	-	40
PS-45/50	450	400	200	35	14,5	125	278	12	45	45	-	45	45	45
	450	400	200	35	14,5	125	305	12	50	50	-	50	50	50
PS-56/63	520	430	215	40	17	155	338	13	56	56	-	56	56	56
	520	430	215	40	17	155	385,5	13	63	63	-	63	63	63
PS-71	490	450	225	50	21	150	445	13	-	71	-	71	71	71
PS-80	600	560	280	50	21	150	490	13	-	80	-	80	80	80
PS-90	620	560	280	60	28	175	547,5	18	-	90	-	90	90	90
PS-100	680	560	280	60	28	185	597,5	18	-	100	-	100	100	100
PS-125	1000	900	300	60	28	285	726,5	18	-	-	125	-	125	125



MS

Support frame to facilitate mounting on-site.

Features:

- Used to facilitate on-site mounting of fans in ducts.

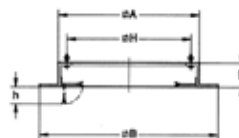

	ØA	ØB	E	ØH	h	Applies to the models	
						CVT/CHT	THT
MS-443	443	615	60	360	70	200/225	-
MS-553	553	725	60	450	70	250/315	-
MS-701	701	875	60	590	90	400/450	-
MS-891	891	1065	60	750	90	500	-
MS-1086	1086	1260	60	850	90	560/630	-



PA

Adaptation plate to mount accessories on roof fans.

Features:

- Used to mount PT, B, BTUB, BAC accessories. Allows fan to be separated from its base without dismantling accessories.

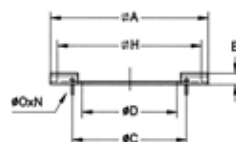

	ØA	ØC	ØD	E	ØH	ØO	Applies to the models	
							N	CVT/CHT
PA-440/250	440	280	249	20	360	M.6	4X90°	220/225
PA-550	550	395	354	20	450	M.6	8X45°	250/315
PA-700/500	700	560	499	20	590	M.10	12X30°	400/450
PA-890/630	890	690	629	20	750	M.10	12X30°	500
PA-1085	1085	770	709	20	850	M.10	16X22°30'	560/630



PT Automatic-closing shutters to work in vertical position

Features:

- Automatic-closing circular shutters to be installed on inlet of roof fans.
- Use of PA adaptor plate recommended for assembly.

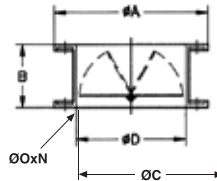

Applies to the models

	ØA	B	ØC	ØD*	ØØxN	CVT/CHT
PT-250	310	150	280	250	10 4X90*	200/225
PT-355	435	200	395	355	10 8X45*	250/315
PT-500	600	280	560	500	12 12X30*	400/450
PT-630	730	355	690	630	12 12X30*	500
PT-710	810	400	770	710	12 16 22'X30*	560/630



ACE/400

400°C/2h elastic coupling to absorb vibrations.

Features:

- Used between the 400°C/2h fan inlet/outlet and the duct to avoid transmitting vibrations.

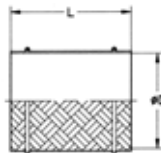

	ØD*	L	Applies to models			Applies to models					
			THT	TCMP	TCR/R	THT	TCMP	TCR/R			
ACE/400-200	200	200	-	820	-	ACE/400-500	500	300	50	2050	1650
ACE/400-224	224	200	-	922	-	ACE/400-560	560	300	56	-	1856
ACE/400-250	250	300	-	1025	-	ACE/400-630	630	300	63	-	2063
ACE/400-280	280	300	-	1128	-	ACE/400-710	710	300	71	-	2271
ACE/400-315	315	300	-	1231	-	ACE/400-800	800	300	80	-	-
ACE/400-355	355	300	-	1435	-	ACE/400-900	900	300	90	-	-
ACE/400-400	400	300	40	1640	1240	ACE/400-1000	1000	300	100	-	-
ACE/400-450	450	300	45	1845	1445	ACE/400-1250	1250	300	125	-	-



REG Record of manual adjustment.

Features:

- Their design allows them to be installed in ducting systems to adjust the airflow.

Model	L	ØD*	Model	L	ØD*
REG-80	100	80	REG-250	100	250
REG-100	100	100	REG-280	100	280
REG-112	100	112	REG-315	100	315
REG-125	100	125	REG-355	100	355
REG-140	100	140	REG-400	100	400
REG-150	100	150	REG-450	150	450
REG-160	100	160	REG-500	150	500
REG-180	100	180	REG-560	150	560
REG-200	100	200	REG-630	250	630
REG-224	100	224	REG-800	250	800

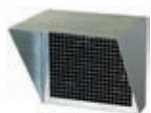

VIS

Outlet hood with protection guard.

Features:

- Prevents objects and water from entering the fan.

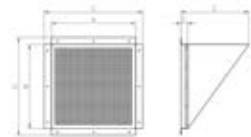

	A	B	C	D	E	F	CJTX-C
VIS-7/7	269	246	309	286	200	50	7/7
VIS-9/9	335	300	375	340	200	50	9/9
VIS-10/10	364	326	404	366	250	50	10/10
VIS-12/12	425	380	465	420	250	50	12/12
VIS-15/15	513	441	573	501	300	50	15/15
VIS-18/18	582	510	642	570	350	50	18/18
VIS-20/20	641	641	741	741	400	50	20/20
VIS-22/22	695	735	795	835	450	50	22/22
VIS-25/25	805	836	905	936	500	50	25/25
VIS-30/28	930	972	1030	1072	600	50	30/28

	A	B	C	D	E	F	CJBDT
VIS-CJBDT-9/9	310	270	-	-	200	80	9/9
VIS-CJBDT-10/10	336	298	-	-	200	80	10/10
VIS-CJBDT-12/12	397	351	-	-	300	80	12/12
VIS-CJBDT-15/15	480	414	-	-	300	80	15/15
VIS-CJBDT-18/18	552	493	-	-	300	80	18/18
VIS-CJBDT-20/20	612	615	-	-	500	80	20/20
VIS-CJBDT-22/22	666	706	-	-	500	80	22/22

	A	B	C	D	E	F	CJMP	CJTCR/R
VIS-820	132	157	-	-	170	56,5	820	-
VIS-922	142	216	-	-	215	56,5	922	-
VIS-1025	167	251	-	-	240	56,5	1025	-
VIS-1128	182	296	-	-	270	56,5	1128	-
VIS-1231	202	321	-	-	290	56,5	1231	-

	A	B	C	D	E	F	CJLINE	CJS
VIS-1240	317	401	-	-	350	56,5	-	1240
VIS-1435	232	281	-	-	260	56,5	1435	-
VIS-1445	357	451	-	-	385	56,5	-	1445
VIS-1640	252	321	-	-	290	56,5	1640	-
VIS-650	402	501	-	-	420	56,5	-	1650
VIS-1845	286	361	-	-	320	56,5	1845	-
VIS-1856	452	561	-	-	-	-	-	1856
VIS-2050	317	451	-	-	385	56,5	2050	-
VIS-2063	502	631	-	-	515	56,5	-	2063
VIS-2271	562	716	-	-	575	56,5	-	2271

	A	B	C	D	E	F	CJLINE	CJS
VIS-1131	560	450	-	-	250	100	1131	-
VIS-1235	620	500	-	-	250	100	1235	-
VIS-1640/E	710	560	-	-	250	100	1640	-
VIS-1845/E	800	630	-	-	250	100	1845/1650/H	-
VIS-1856/E	1000	800	-	-	250	100	1856-1856/H	-
VIS-2063/E	1120	900	-	-	250	100	2063-2063/H	-
VIS-2271/E	1190	900	-	-	250	100	2271-2271/H	-
VIS-2880	1250	1000	-	-	250	100	2880	-
VIS-100	600	600	698	698	485	-	-	1240/1850
VIS-200	725	725	823	823	576	-	-	2056/2263-6T
VIS-300	800	800	898	898	630	-	-	2263-4T/2071-6T-3
VIS-400	860	860	958	958	674	-	-	2071-4T/6T-5,5/2880



TEJ Outside covers.

Features:

- Avoids water entering ventilation units installed outside.

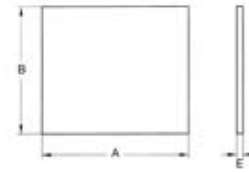

	Applies to models					
	A	B	E	CJMP	CJTCR/R	CJS
TEJ-820	500	550	26	820	-	-
TEJ-922	710	710	26	922	-	-
TEJ-1025	760	760	26	1025	-	-
TEJ-1128	820	820	26	1128	-	-
TEJ-1231	900	900	26	1231	-	1240/1850
TEJ-1435	980	980	26	1435	-	-

	Applies to models					
	A	B	E	CJMP	CJTCR/R	CJS
TEJ-1640	1071	1070	26	1640	1240	2056/2263-6T
TEJ-1845	1170	1170	26	1845	1445	2263-4T/2071/2280
TEJ-1856	1360	1150	26	-	1856	-
TEJ-2050	1260	1260	26	2050	1650	-
TEJ-2063	1500	1300	26	-	2063	-
TEJ-2271	1655	1455	26	-	2271	-

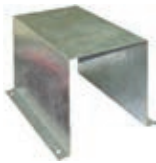

CM Motor cover for outside work.

Features:

- Avoids water entering motors installed outside.

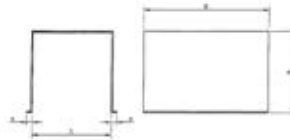

Model	A	B	C	D	Applies to motors of:
					CV
CM-1	15	260	200	300	0.25 to 1
CM-2	15	260	240	300	1.5 to 2
CM-5.5	15	300	270	330	3 to 5.5
CM-10	15	380	320	450	7.5 to 10
CM-20	15	440	350	530	15 to 20
CM-30	15	440	360	550	more than 20



TAC Circular coupling plate.

Features:

- To change rectangular outlet of unit CJS and CJLINE to circular

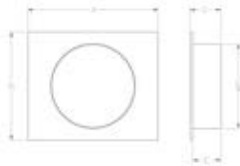

	Applies to models					
	A	B	C	ØD	E	CJS CJLINE
TAC-100	698	698	80	400	50	1240/1850 -
TAC-200	823	823	80	560	50	2056/2263-6T -
TAC-300	898	898	80	630	50	2263-4T/2071-6T-3 -
TAC-400	958	958	80	710	50	2071-4T/6T-5.5/2880 -
TAC-1131	615	505	165	400	150	- 1131
TAC-1235	695	575	165	450	150	- 1235
TAC-1640	785	635	165	500	150	- 1640
TAC-1845	875	705	165	560	150	- 1845
TAC-1856	1075	875	165	700	150	- 1856
TAC-2063	1195	975	165	800	150	- 2063
TAC-2271	1265	975	165	800	150	- 2271
TAC-2880	1325	1075	165	900	150	- 2880



S Silencers to fit to inlet or outlet.

Features:

- Circular or rectangular silencers to fit to inlet or outlet on centrifugal or axial fans.

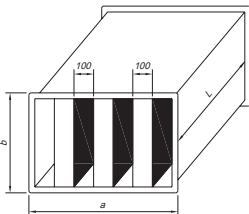

INLET / OUTLET (Rectangular cross section)

	L	a	b	Kg	Replacement dampers (dB) on octave band (Hz)						
					125	250	500	1000	2000	4000	Applicable
SR-1000/900/900	900	1000	900	64	4	10	21	37	44	37	THT-63
SR-1200/900/900	900	1200	900	74	4	10	21	37	44	37	THT-71
SR-1400/1200/900	900	1400	1200	102	4	12	25	41	47	42	THT-80
SR-1800/1200/1200	1200	1800	1200	169	4	12	25	41	47	42	THT-90
SR-1800/1500/1200	1200	1800	1504	195	4	12	25	41	47	42	THT-100

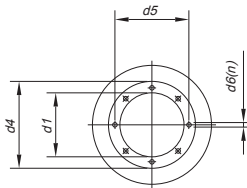

INLET / OUTLET (Circular cross section)

	L	d1	d2	l	d3	d4	d5	d6	n	Kg	Replacement dampers (dB) on octave band (Hz)						
											125	250	500	1000	2000	4000	Applicable
SC-630/900	900	630	800	100	630	720	690	12	12x22°30'	44	5	8	14	12	13	9	THT-63
SC-710/900	900	710	900	100	710	800	770	12	16x22°30'	65	5	8	13	11	12	8	THT-71
SC-800/900	900	800	1000	100	800	900	860	12	16x22°30'	70	4	8	11	9	9	8	THT-80
SC-900/1200	1200	900	1120	100	900	1000	970	15	16x22°30'	87	5	7	11	11	7	5	THT-90
SC-1000/1200	1200	1000	1200	100	1000	1100	1070	15	16x22°30'	95	4	7	11	10	7	6	THT-100

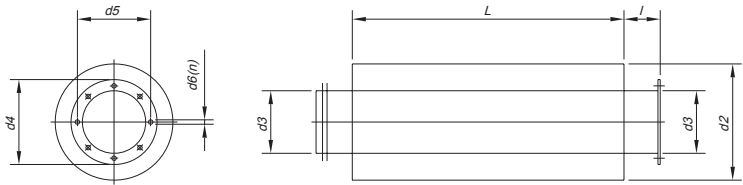

INLET

	L	d2	d3	d4	d5	d6	n	Kg	Replacement dampers (dB) on octave band (Hz)						Applicable
									125	250	500	1000	2000	4000	
S-250/600	600	450	250	310	280	10	4x90°	14	5	12	20	24	23	14	CVT-CHT-200/225
S-355/900	900	560	355	430	395	10	8x45°	25	4	12	20	24	18	14	CVT-CHT-250/315
S-500/900	900	710	500	590	560	12	12x30°	35	4	11	18	16	14	11	CVT-CHT-400/450
S-630/900	900	800	630	720	690	12	12x30°	41	5	8	14	12	13	9	CVT-CHT-500
S-710/900	900	900	710	800	770	12	16x22°30'	65	5	8	13	11	12	8	CVT-CHT-560/630



INLET

	L	d1	d2	l	d3	d4	d5	d6	n	Kg	Replacement dampers (dB) on octave band (Hz)						Applicable
											125	250	500	1000	2000	4000	
S-315/600/922-A	600	315	500	238	220	278	256	9	8x45°	16	4	8	14	17	14	12	TCMP/CTMP-922
S-355/900/1025-A	900	355	560	224	245	305	282	9	8x45°	25	4	12	20	24	23	14	TCMP/CTMP-1025
S-400/900/1128-A	900	400	600	250	270	348	320	9	8x45°	29	5	12	19	22	18	13	TCMP/CTMP-1128
S-450/900/1231-A	900	450	630	291	295	382	354	9	8x45°	32	5	12	18	20	16	12	TCMP/CTMP-1231
S-500/900/1435-A	900	500	710	284	345	422	394	9	8x45°	35	4	11	18	16	14	11	TCMP/CTMP-1435
S-500/900/1640-A	900	500	710	227	395	464	438	9	8x45°	35	4	11	18	16	14	11	TCMP/CTMP-1640
S-560/900/1845-A	900	560	750	241	445	515	485	9	8x45°	41	4	10	16	14	13	10	TCMP/CTMP-1845
S-630/1200/2050-A	1200	630	800	269	495	565	535	11	8x45°	56	6	13	18	15	15	12	TCMP/CTMP-2050
S-800/1200/2563-A	1200	800	1000	370	595	710	675	14	8x45°	80	5	9	13	11	11	9	TCMP/CTMP-2563
S-400/900/1031-A	900	400	600	202	320	383	356	9	8x45°	29	5	12	19	22	18	13	TCR/R / TCR-1031
S-450/900/1135-A	900	450	630	216	345	425	398	9	8x45°	32	5	12	18	20	16	12	TCR/R / TCR-1135
S-500/900/1240-A	900	500	710	227	395	472	444	11	8x45°	35	4	11	18	16	14	11	TCR/R / TCR-1240
S-560/900/1445-A	900	560	750	241	445	522	495	11	8x45°	41	4	10	16	14	13	10	TCR/R / TCR-1445
S-630/1200/1650-A	1200	630	800	269	495	582	555	11	8x45°	56	6	13	18	15	15	12	TCR/R / TCR-1650
S-710/900/1856-A	900	710	900	301	555	645	615	11	8x45°	65	5	8	13	11	12	8	TCR/R / TCR-1856
S-800/900/2063-A	900	800	1000	329	625	720	688	11	8x45°	70	4	8	11	9	9	8	TCR/R / TCR-2063
S-800/1200/2271-A	1200	800	1000	224	705	800	768	13	8x45°	80	5	9	13	11	11	9	TCR/R / TCR-2271

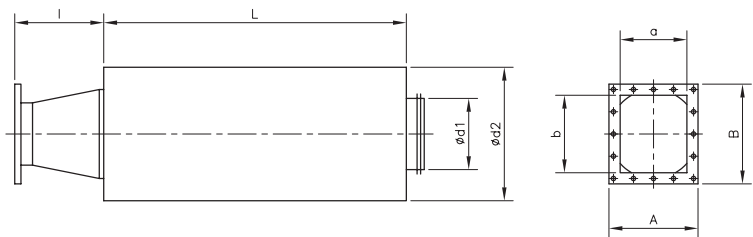

OUTLET (Rectangular flange)

	L	d1	d2	l	a	b	A	B	Kg	Replacement dampers (dB) on octave band (Hz)						Applicable
										125	250	500	1000	2000	4000	
S-315/600/922-I	600	315	500	300	216	140	282	204	16	4	8	14	17	14	12	TCMP/CTMP-922
S-355/900/1025-I	900	355	560	300	250	165	314	229	25	4	12	20	24	23	14	TCMP/CTMP-1025
S-400/900/1128-I	900	400	600	300	300	180	364	544	29	5	12	19	22	18	13	TCMP/CTMP-1128
S-450/900/1231-I	900	450	630	300	320	200	384	266	32	5	12	18	20	16	12	TCMP/CTMP-1231
S-500/900/1435-I	900	500	710	300	280	228	344	394	35	4	11	18	16	14	11	TCMP/CTMP-1435
S-500/900/1640-I	900	500	710	300	320	250	404	336	35	4	11	18	16	14	11	TCMP/CTMP-1640
S-560/900/1845-I	900	560	750	450	360	284	444	370	41	4	10	16	14	13	10	TCMP/CTMP-1845
S-630/1200/2050-I	1200	630	800	450	450	315	545	412	56	6	13	18	15	15	12	TCMP/CTMP-2050
S-800/1200/2563-I	1200	800	1000	450	600	410	706	512	80	5	9	13	11	11	9	TCMP/CTMP-2563
S-400/900/1031-I	900	400	600	300	315	250	385	320	29	5	12	19	22	18	13	TCR/R / TCR-1031
S-450/900/1135-I	900	450	630	450	355	280	425	350	32	5	12	18	20	16	12	TCR/R / TCR-1135
S-500/900/1240-I	900	500	710	450	400	315	480	395	35	4	11	18	16	14	11	TCR/R / TCR-1240
S-560/900/1445-I	900	560	750	450	450	355	540	445	41	4	10	16	14	13	10	TCR/R / TCR-1445
S-630/1200/1650-I	1200	630	800	450	500	400	590	490	56	6	13	18	15	15	12	TCR/R / TCR-1650
S-710/900/1856-I	900	710	900	450	560	450	660	550	65	5	8	13	11	12	8	TCR/R / TCR-1856
S-800/900/2063-I	900	800	1000	450	630	500	750	620	70	4	8	11	9	9	8	TCR/R / TCR-2063
S-800/1200/2271-I	1200	800	1000	450	710	560	840	690	80	5	9	13	11	11	9	TCR/R / TCR-2271
S-800/1201/2380-I	1200	800	1000	450	560	800	680	920	90	5	9	13	11	11	9	TCR/R / TCR-2380

Alphabetical index of references

CBDT	115	CJTHT/PLUS	20
CHT	183	CJTX-C	143
CI	107	CSX	162
CJBDT	115	CTMP	122
CJEC	180	CVT	183
CJLINE	175	HTMF	109
CJMD	128	KIT DE SOBREPRESIÓN	188
CJMP	137	TCMP	137
CJS	125	TCR	119
CJSRX	172	TCR/R	132
CJSX	155	THT	12
CJTCCR/R	132	THT/IMP	97
CJTHT	24	TÚNEL JETFAN	101
CJTHT/DUPLEX/ATEX	30	VMSF	105

Alphabetical index of references ACCESSORIES

ACE-400	201	P-400	198
AR	194	PA	200
B	199	PL	198
BAC	200	PS	200
BD	199	PT	201
BIC	200	R/THT	198
BTUB	199	REG	201
C2V	194	REJ	202
CABLE BOX	194	RFM	195
CENTRAL CO	192	RFT	195
CM	202	RM	194
ELECTRICAL PANELS	197	RPA	198
IAT	194	RT	198
INT	194	S	202
MS	200	TAC	202
P	198	VIS	201

OUR PRODUCTS



In-line duct fans



Axial fans



Centrifugal fans



Fans for smoke extraction
400°C/2h - 300°C/2h



ATEX Fans for explosive atmospheres

NEW



Roof fans



Ventilation systems
for houses



Heat recovery units



Filtration units



Air curtains



Efficient Energy Applications

NEW



Ask us for information.

Ventilation Software. General Catalogue.



Crta. de Berga, km 0.7
E-08580 St. Quirze de Besora
BARCELONA (Spain)
Tel. +34 93 852 91 11
Fax. +34 93 852 90 42

comercial@sodeca.com
Export sales: ventilation@sodeca.com
www.sodeca.com





Ctra. de Berga, km 0,7
 E-08580 SANT QUIRZE DE BESORA
 (Barcelona - Spain)
 Tel. +34 93 852 91 11
 Fax +34 93 852 90 42
 comercial@sodeca.com
 Export sales: ventilation@sodeca.com
 www.sodeca.com



Export Sales

SODECA EXPORT
 Ctra. de Berga, km 0,7
 E-08580 SANT QUIRZE
 DE BESORA
 Barcelona - SPAIN
 Tel. +34 93 852 91 11
 Fax +34 93 852 90 42
 ventilation@sodeca.com

PORTUGAL
 Sr. Albert Bartés
 E-08580 SANT QUIRZE DE
 BESORA
 Barcelona - SPAIN
 Tel. +34 93 852 91 11
 Fax +34 93 852 90 42
 comercial@sodeca.com

**SODECA AMÉRICA
 USA - CANADÁ - MÉXICO
 AMÉRICA DEL SUR**
 Sr. Francesc Bertran
 Sodeca Ventiladores Ltda
 Avda. Puerta Sur 03380
 San Bernardo, SANTIAGO, CHILE
 ventas.chile@sodeca.com
 Tel. +56 (02) 2840 5582

SODECA ÁREA CARIBE
 Sr. Carlos A. Hernández Gil
 Residencial Miramar N° 120B-7ma
 Ave. N° 1805 entre 18 y 20.
 Miramar Playa, CIUDAD DE LA
 HABANA, CUBA
 Tel. 00537 20 43721
 sodeca@enet.cu



Ctra. de Berga, km 0,7
E-08580 SANT QUIRZE DE BESORA
(Barcelona - Spain)
Tel. +34 93 852 91 11
Fax +34 93 852 90 42
comercial@sodeca.com
Export sales: ventilation@sodeca.com

www.sodeca.com

