

2016/2017

# HYDRAULIC RESCUE SYSTEMS



**E FORCE 2**

**WEBER RESCUE**  
SYSTEMS

[www.weber-rescue.com](http://www.weber-rescue.com)

## WITH NEW TECHNOLOGIES INTO THE FUTURE

New vehicle technologies and continuously optimised safety systems in vehicles improve the protection of the occupants. However, they are always presenting new challenges for the emergency services. WEBER RESCUE SYSTEMS provides for this trend by continuously developing high-performance rescue systems.

We have the right rescue equipment for practically any scenario. In recent years, our innovations have been focused around flexible, battery-operated tools in the E-FORCE series. However, our standard range has also been advanced with new generations of cutters and blades (RSU PLUS), new spreaders (AS and BS spreaders) and power units (E/V 70 W).

We offer a comprehensive range of tried-and-tested solutions, now complemented by additional equipment such as the STAB-FAST ALU, PAT-STAB and PAT-SAFE.

A further component of our success is our worldwide training and education programmes for emergency service personnel. An example of this is our RESCUE DAYS events, which are now held in multiple countries (Austria, Brazil, Japan, etc.) and at which thousands of fire service and rescue personnel have already been trained.

You can get the best overview of the many advantages of our systems during a personal product presentation at your own location, where you can discover for yourself what lies behind the experience of WEBER RESCUE products.

You can find more interesting information on our products and services at [www.weber-rescue.com](http://www.weber-rescue.com).

The WEBER RESCUE Sales Team

**WEBERRESCUE**  
SYSTEMS



# CONTENT

NEW TECHNOLOGIES	4
SPREADERS	6
CUTTERS	10
COMBI TOOLS	16
RESCUE RAMS	20
POWER UNITS	24
COMPACT POWER UNITS AND HOSES	28
E-FORCE 2 BATTERY TOOLS	34
LIGHT-TOOLS	42
LIFTING EQUIPMENT	44
STABILISATION	48
ACCESSORIES	54
S'SERIES	62
TRAINING	66



**WEBER**  
*Instructor*



## WEBER RESCUE PRODUCTS WITH THE LATEST TECHNOLOGIES!

 <b>PLUS</b>	Changeable inserts made of high strength alloy
 <b>COAX</b>	Hose-in-hose-system for better handling
 <b>SINGLE</b>	Quick and easy connection of hoses with one movement without unintended release
 <b>360° HANDLE</b>	Rotatable (360°) and detachable handle
 <b>CHARGE</b>	Rechargeable Li-Ion batteries for independent operation
 <b>XTREME</b>	Xtreme cutting technology for excellent cutting, especially for latest materials
 <b>COMPACT</b>	Best capacity on minimum space and low weight
 <b>ECO</b>	Removes extra noise and stress by automatic speed control
 <b>TURBO-SPEED</b>	Maximum power through double speed „turbo“ operation of one tool
 <b>PUSH-CONTROL</b>	Unique WEBER control for fine tuned precision handling
 <b>GRIP</b>	Spikes for extra grip
 <b>ULTIMATIVE</b>	High-strength, forged blades for hardest applications
 <b>PERFORMANCE</b>	Higher working speed by means of more power
 <b>EXTENDIBLE</b>	Creates space in the interior



# NUEVA GENERACION DE CUCHILLAS



Blades	ULTIMATIVE	others
Cutting performance	+++	+
Stability/ Safety	+++	+
Blade inserts	✓	✗
Weight	3.6 kg	3.9 kg

- High-strength, forged lightweight design blades
- Further optimised ULTIMATE blade design for hardest applications
- Adjustable fibre-reinforced handle for perfect handling

# THE NEW MOBILITY

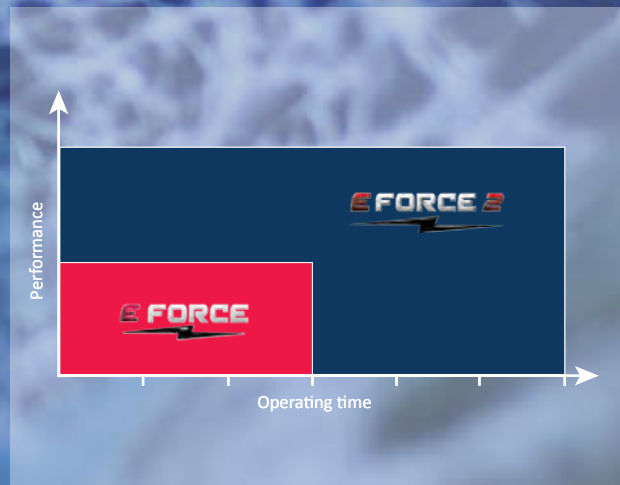

- New, efficient and improved drive unit for longer working time at higher speed
- LED lights for better view in the working area
- Long operating time due to 5.0 Ah capacity





# USE MEETS BITE

*WEBER RESCUE high performance spreaders*

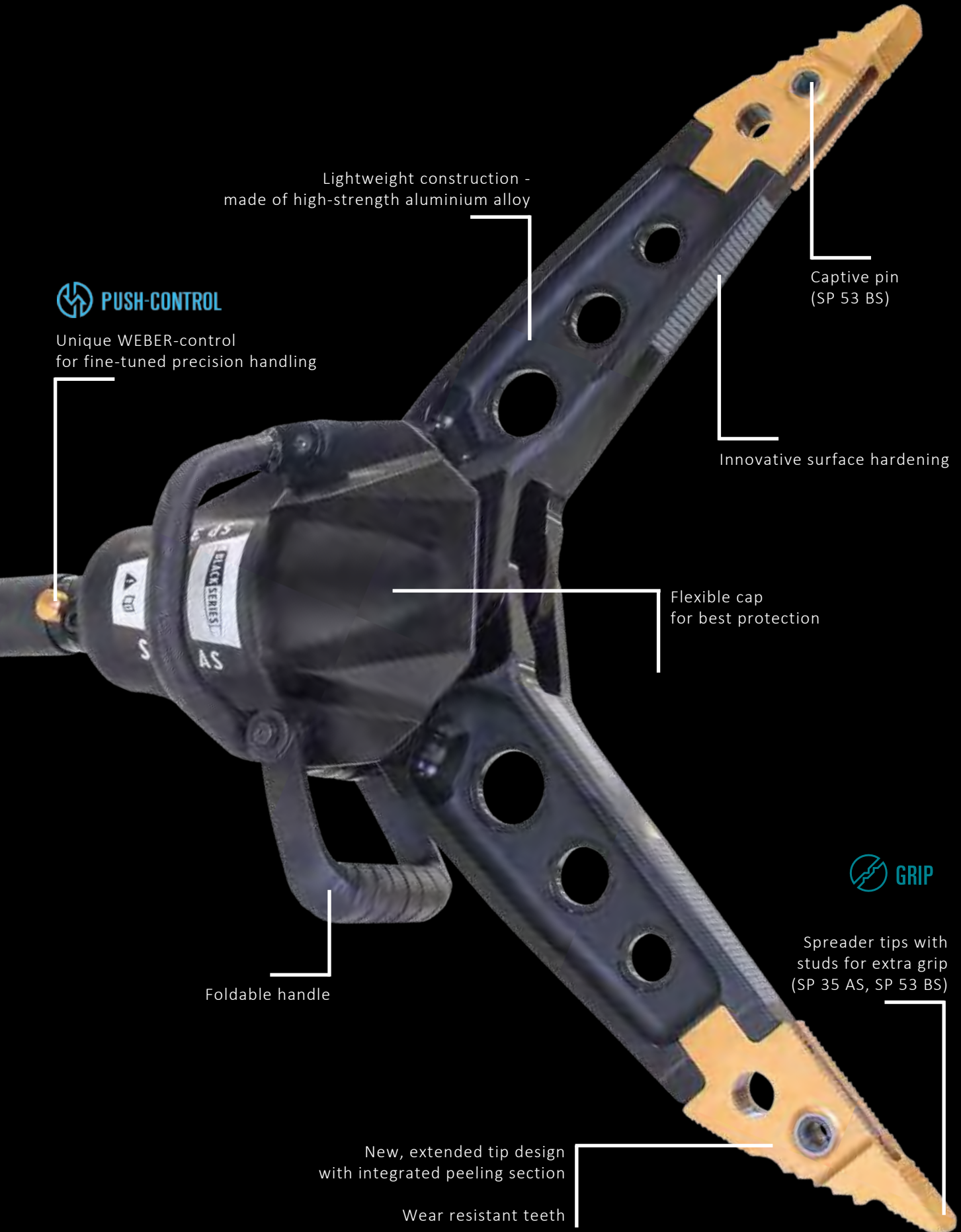

Lightweight construction -  
made of high-strength aluminium alloy



Unique WEBER-control  
for fine-tuned precision handling

Captive pin  
(SP 53 BS)

Innovative surface hardening

Flexible cap  
for best protection

Foldable handle



Spreader tips with  
studs for extra grip  
(SP 35 AS, SP 53 BS)

New, extended tip design  
with integrated peeling section

Wear resistant teeth



# TIPS AND TRICKS FISH CAN

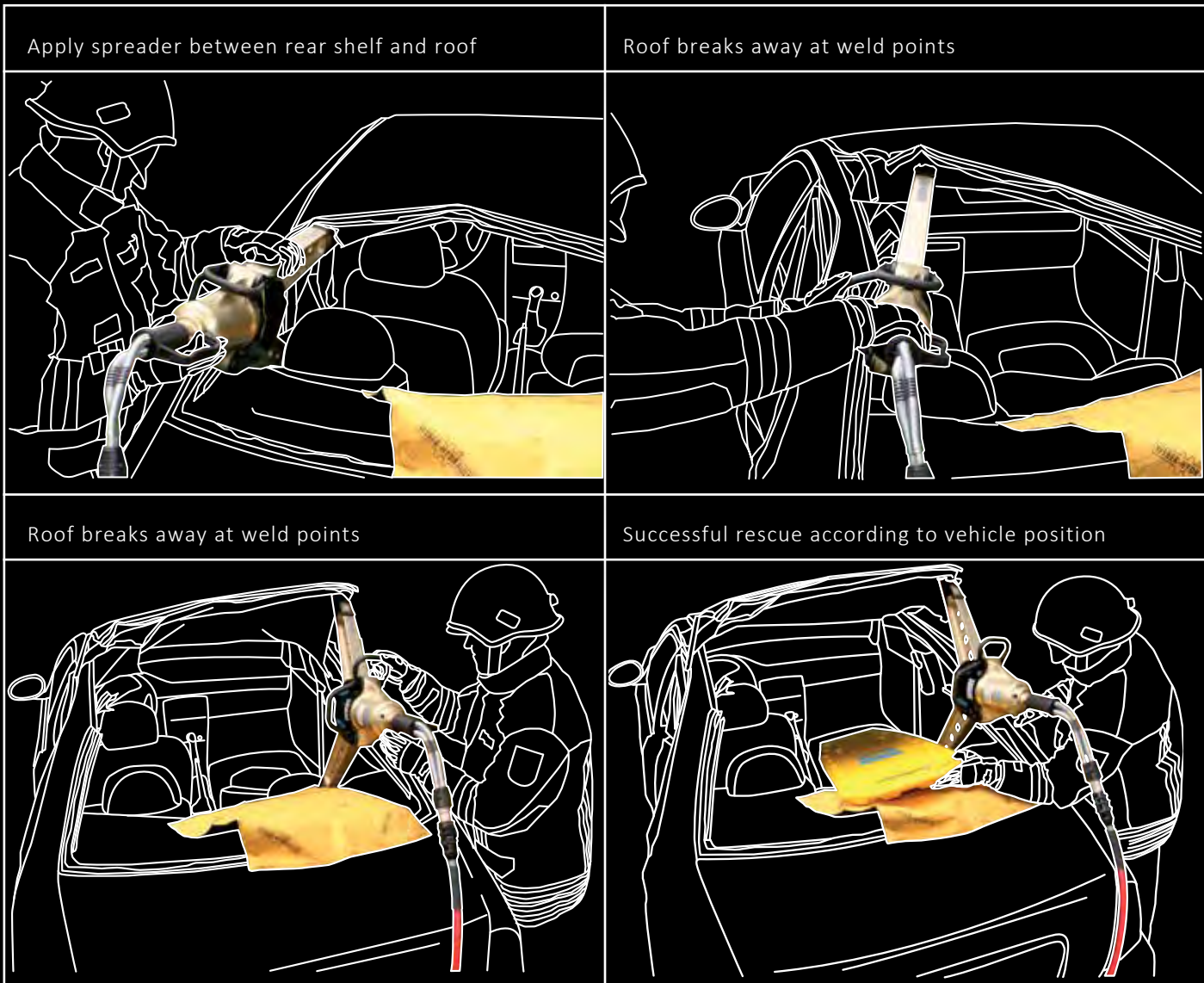

# SPREADERS

**NEW!**

Type	SP 35 AS	SP 49	SP 53 BS	SP 60	SP 80
Spreading force in working range*	35-171 kN	49-330 kN	53-421 kN	63-492 kN	88-470 kN
Closing force*	76 kN	101 kN	100 kN	110 kN	102 kN
Spreading distance	600 mm	710 mm	800 mm	810 mm	620 mm
Weight	14.6 kg	19.9 kg	20.3 kg	24.7 kg	25.1 kg
EN class	AS 35/600-15	AS 49/710-20	BS 53/800-20	BS 63/810-25	CS 87/600-25
Part no.	1071373	5933633	1058125	5931479	5930758

\*according to EN 13204 to 700 bar



## SP 35 AS

- Lightweight spreader (only 14.6 kg)
- Long arms for extra control and stability
- Large opening of 600 mm
- Captive pin and new tips with studs for extra grip
- Meets AS norm



## SP 53 BS

- One of the most lightweight BS spreader (EN norm) worldwide
- Ideally suited to today's automotive materials and demands!
- Large opening of 800 mm
- Captive pin and new tips with studs for extra grip
- Meets BS norm



SP 35 AS



SP 53 BS

TEAM  
**gold**  
Power  
redefined



# SPREADERS



SP 49



SP 60



SP 80

## Replacement tips

SP 35 AS	1074746
SP 49	3885593
SP 53 BS	1068392
SP 60	3878368
SP 80	3878376

## ACCESSORIES

### Chain set consisting of:

2 pcs. chain lock, 2 pcs. pulling chain 1.8 m long with hooks. The length of chains can easily be adjusted through a push-button at the chain lock.

SP 53 BS	571415
SP 35 AS, SP 49 und SP 60	2819139
SP 80	2840138



# THE NEW GENERATION OF CUTTERS



*THE ULTIMATIVE Cutter with blade inserts*

**BLACK SERIES**

 **ULTIMATIVE**

Further optimised blade- and cutting edge design for hardest applications

Unique WEBER-control for fine-tuned precision handling

 **PUSH-CONTROL**

Rotatable and detachable handle - ideal for restricted and confined space operation

 **HANDLE**

High-strength, forged lightweight design blades

Replaceable blade inserts for long lasting performance

 **PLUS**





# TIPS AND TRICKS TWIST GRIP



Start position horizontal grip, screw open

For vertical cutting turn control handle

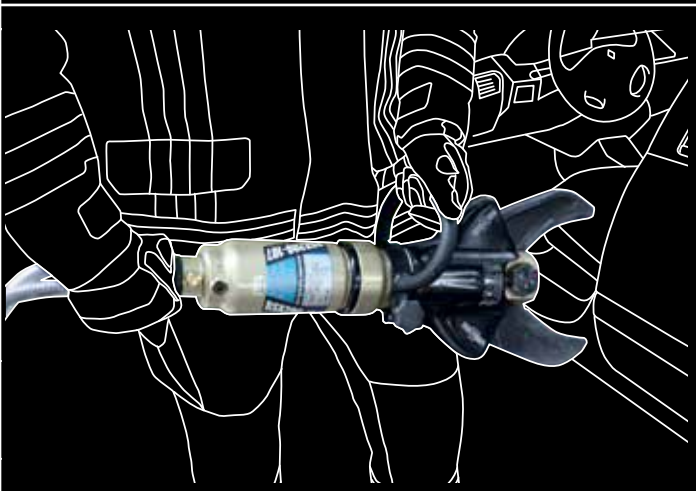
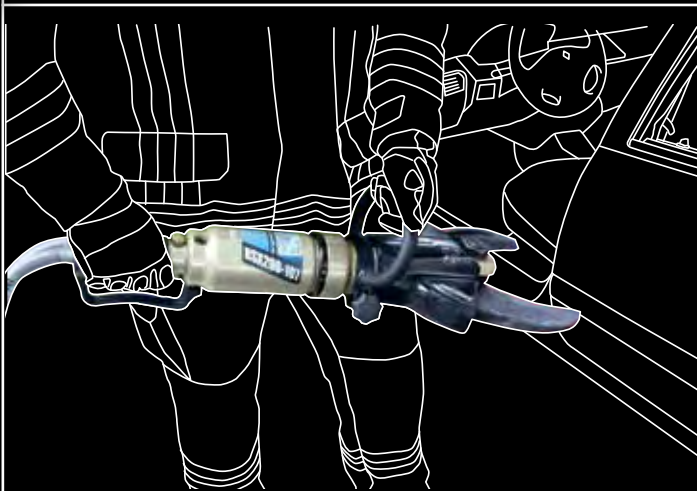

Carrying handle, hinders working

Handle turned away, uninterrupted working possible

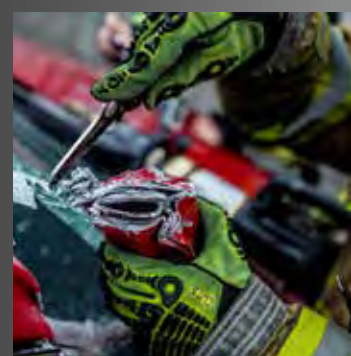
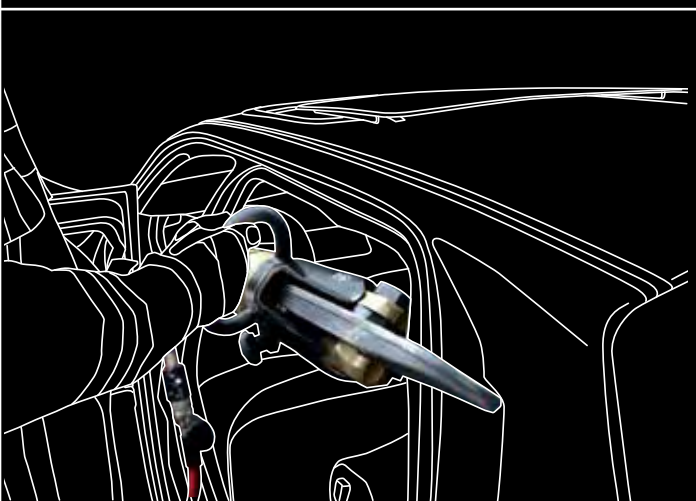
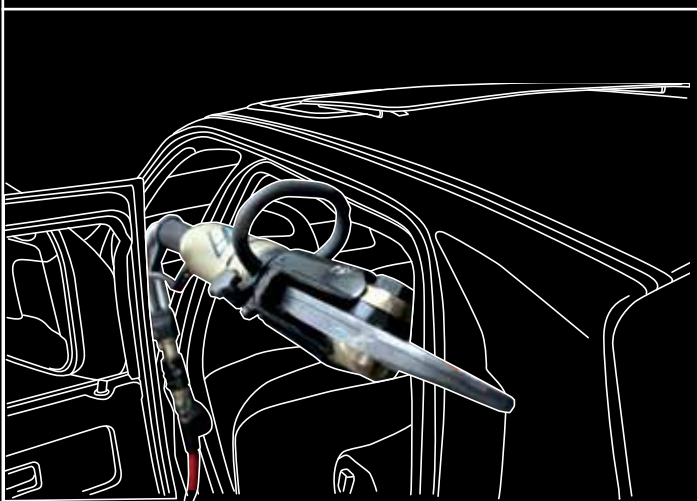

# CUTTERS

## THE PROVEN BLADE SHAPE - RSX

Type	RSX 105-29	RSX 160-50	RSX 180-80
Opening	105 mm	163 mm	180 mm
Max. cutting force*	29 t/282 kN	50 t/500 kN	92 t/903 kN
Max. cutting force (round steel bar)*	∅ 22 mm	∅ 32 mm	∅ 35 mm
Weight	9.3 kg	14.6 kg	17.6 kg
EN class	AC 105-E-9	BC 160-H-15	BC 180-H-18
NFPA class	A5/B4/C5/D6/E6	A7/B7/C6/D7/E8	A7/B9/C7/D9/E9
Part no.	5936780	1050539	1059226

Type	RSX 185-105	RSX 200-107
Opening	185 mm	200 mm
Max. cutting force*	105 t/1.030 kN	107 t/1.050 kN
Max. cutting force (round steel bar)*	∅ 45 mm	∅ 43 mm
Weight	22.5 kg	19.9 kg
EN class	CC 240-H-23	CC 200-H-20
NFPA class	A9/B9/C9/D9/E9	A8/B9/C7/D9/E9
Part no.	5932939	5935849

## ...WITH REPLACEABLE INSERTS

Type	RSX 180-80 PLUS
Opening	180 mm
Max. cutting force*	92 t/903 kN
Max. cutting force (round steel bar)*	∅ 35 mm
Weight	17.8 kg
EN class	BC 180-H-18
NFPA class	A7/B9/C7/D9/E9
Part no.	1059226SIP

### Upgrade to RSX 180-80 PLUS:

	Weight	Part no.
RS 170	8.3 kg	1062138
RS(X) 165-65, S 270-71	8.3 kg	1062134

TEAM  
*gold*  
licence to cut



# NEW GENERATION OF CUTTERS

# RSU



1 kg lighter due to  
new blade shape

 **ULTIMATIVE**



Type	RSU 200-107 PLUS
Opening	200 mm
Max. cutting force*	107 t/1.050 kN
Max. cutting force (round steel bar)*	∅ 43 mm
Weight	19.8 kg
EN class	CC 200-H-20
NFPA class	A8/B9/C8/D9/E9
Part no.	1069498

\*according to EN 13204 to 700 ba

## ACCESSORIES

Replacement blade	Part no.	Weight
RSX 105-29	1825518	1.1 kg
RSX 160-50	1050557	2.3 kg
RSX 180-80	1059813	3.2 kg
RSX 185-105	1823035	4.0 kg
RSX 200-107	1822608	3.4 kg

Replacement blade	Weight	Part no.
<b>Blade without insert</b>		
RSX 180-80 PLUS	3.1 kg	1059363
RSU 200-107 PLUS	3.3 kg	1072763
<b>Blade insert</b>		
RSX 180-80 PLUS	0.2 kg	1061568
RSU 200-107 PLUS	0.3 kg	1075983
<b>Blade complete (with insert)</b>		
RSX 180-80 PLUS	3.3 kg	1059362
RSU 200-107 PLUS	3.6 kg	1078502
<b>Inserts in bag (2 pcs.)</b>		
RSX 180-80 PLUS	1.1 kg	1061567
RSU 200-107 PLUS	1.1 kg	1078501

# SPECIALISED CUTTERS

## C 100-31

- Specialised tool for continuous cutting
- Surplus materials is automatically removed
- Special serrated surface for aggressive cutting

Opening	120 mm
Max. cutting force*	31 t/308 kN
Weight	19.5 kg
EN class	AC 120-C-20
NFPA class	A4/B3/C5/D6/E6
Part no.	5935199

### Replacement blade:

<b>C 100-31 Blade</b>	1051463
<b>C 100-31 Lower blade right</b>	1051474
<b>C 100-31 Lower blade left</b>	1051475



## S 220-54 AND S 270-71

- Very large opening width
- Serrated blades
- Low weight

	<b>S 220-54</b>	<b>S 270-71</b>
Opening	220 mm	280 mm
Max. cutting force*	54 t/533 kN	71 t/699 kN
Max. cutting force (round steel bar)*	∅ 25 mm	∅ 36 mm
Weight	14.4 kg	17.0 kg
EN class	BC 170-H-14	CC 218-H-17
NFPA class	A6/B7/C6/D8/E8	A7/B8/C7/D8/E9
Part no.	1063372	5932084

### Replacement blade:

<b>S 220-54 Blade</b>	1063374
<b>S 270-71 Blade</b>	1808559



## S 50-14

- Tension-free cutting, no uncontrolled movement of the material being cut
- Compact – for use in confined spaces such as vehicle foot wells
- Lightweight – for one-handed operation

Opening	50 mm
Max. cutting force*	19 t/181 kN
Max. cutting force (round steel bar)*	∅ 16 mm
Weight	4.3 kg
EN class	AC 50-B-4
NFPA class	A4/B3/C2/D4/E3
Part no.	2833395

### Replacement blade:

<b>S 50-14 Upper blade</b>	3863670
<b>S 50-14 Lower blade</b>	3863689



\*according to EN 13204 to 700 bar



## CONCRETE CRUSHER BC 250

- For heavy operation in event of natural disasters, collapsed buildings and industrial incidents
- To break away thick pieces of concrete
- Rotatable grip handle and protection shield
- Changeable tips
- Also available in battery version (E-FORCE)

<b>Opening</b>	250 mm
<b>Max. closing force*</b>	11 t/109 kN
<b>Weight</b>	18.1 kg
<b>Part no.</b>	1063190

<b>BC 250 Replacement tips</b>	1065132
--------------------------------	---------



**NEW!**

## CUTTER S 25-20

- Rescue tool for disasters, such as earthquakes and building collapses
- For cutting of metal rods, chains, locks and reinforcements
- One-handed operation possible

<b>Max. cutting force*</b>	19,5 t/191 kN
<b>Weight</b>	7.7 kg
<b>Part no.</b>	1065612

<b>S 25-20 Replacement tips</b>	1065665
---------------------------------	---------





# EFFICIENCY MEETS VARIETY

*Cutting, spreading, pushing and pulling - with one tool!*

## PUSH-CONTROL

Unique WEBER-control for fine-tuned precision handling

## 360° HANDLE

Removable 360° adjustable handle - ideal for restricted and confined space operation

SPS 370 and SPS 400 with detachable tips and highest cutting class "H"

Blades can be re-sharpened and are complete with a notch for cutting round bars

Compatible with chain set and mechanical rescue rams





# TIPS AND TRICKS MAKING A GAP

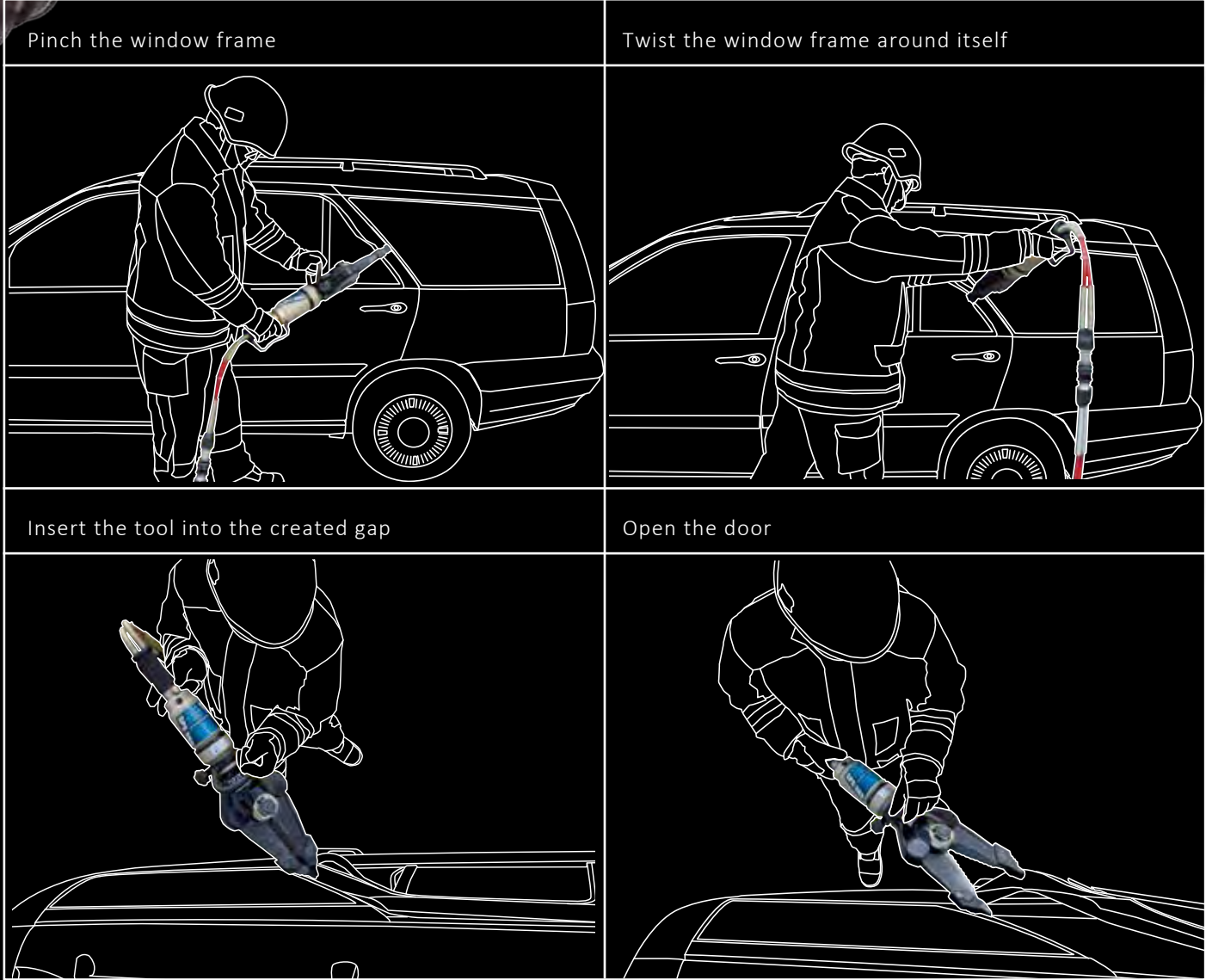

# COMBI TOOLS



	SPS 270	SPS 360 L	SPS 370	SPS 400
Spreading distance	270 mm	360 mm	370 mm	425 mm
Max. cutting force*	33 t/324 kN	50 t/491 kN	50 t/491 kN	54 t/526 kN
Cutting force (round steel bar)	∅ 25 mm	∅ 30 mm	∅ 30 mm	∅ 35 mm
Spreading force in working range*	32-591 kN	39- 783 kN	36-783 kN	35 - 726 kN
Pulling force (with pulling device)	39 kN	52 kN	52 kN	63 kN
Pulling width (with pulling device)	345 mm	346 mm	346 mm	402 mm
Weight	10.8 kg	14.9 kg	16.0 kg	18.3 kg
EN class	BK 30/265-F-11	CK 37/360-H-15	CK 37/370-H-16	CK 36/420-H-18
NFPA class	A6/B5/C6/D6/E7	A6/B8/C6/D8/E7	A6/B8/C6/D8/E7	A7/B9/C7/D9/E9
Part no.	1055954	1062580	1063314	5931134

\*according to EN 13204 to 700 bar



**SPS 370 and SPS 400  
with detachable tips!**



**Confirmação**  
according to EN 13204

Date of test: 05.11.2014  
Prüfdatum: 05.11.2014  
Date de test: 05.11.2014

Manufacturer  
Hersteller  
Fabricant

Classification  
Klassifizierung  
Classification

Modell  
Type  
Modèle

Order number  
Identif. Nr.  
Número d'Identité

Working pressure  
Arbeitsdruck  
Pression de travail

The tests mentioned in this attestation have been carried out under the supervision of German Testing Institute.  
Les tests décrits dans ce confirmation ont été réalisés sous surveillance de l'institut de contrôle allemand.

TUV SUD Auto Services GmbH  
Gottlieb-Daimler-Straße 7  
D-70794 Filderstadt

Die in dieser Bestätigung bescheinigten Prüfungen wurden durchgeführt unter der Aufsicht des Prüfinstitutes.

Das oben genannte hydraulische Kombigerät entspricht der DIN EN 13204 (09/2012).  
L'ustensile hydraulique-combiné mentionné ci-dessus correspond à DIN EN 13204 (09/2012).

Result / Ergebnis / Résultat :

Above mentioned hydraulic combi tool conforms to DIN EN 13204 (09/2012).  
Das oben genannte hydraulische Kombigerät entspricht der DIN EN 13204 (09/2012).  
L'ustensile hydraulique-combiné mentionné ci-dessus correspond à DIN EN 13204 (09/2012).

Clearer Bescheinigung gilt für Geräte, die den Anforderungen entsprechen und in identischer Ausführung sind.

Filderstadt 06.03.2014  
Beck

K 04-2013

Diese Bestätigung ist unter der Nummer abgelegt, die bei jedem Schriftwechsel mit anzugeben ist.



## HAND-VARIO SPS 260 H

Manual powered combitool with integrated hydraulic drive

- Small space required for storage
- Agile handling
- Light weight
- Head can be rotated to any position within 360°

Opening	260 mm
Max. cutting force	29 t/281 kN
Cutting force (round steel bar)	Ø 25 mm
Spreading force in working range	33 – 383 kN
Weight	11.2 kg
DIN class (DIN 14751-4)	K 25 E-M
NFPA class	A6/B6/C6/D7/E7
Part no.	5934397

## ACCESSORIES

<b>Replacement (arm)</b>	
SPS 270 and SPS 260 H	1819240
SPS 360 L	1068993
SPS 370	1063315
SPS 400	1810499
<b>Pulling device, with pin for fastening the chains on the blades (arms). 2 pieces required</b>	
SPS 270 and SPS 260 H	2096617
SPS 360 L	2835746
SPS 370 and SPS 400	2836033
<b>Chain set</b>	
SPS 270	571407
SPS 360 L, SPS 370 and SPS 400	2819139
<b>Spreader tip</b>	
SPS 370 and SPS 400	3867323
<b>Rescue ram RZM 740</b>	
SPS 260 H, SPS 270 and SPS 360 L	1056478



# Passion meets dynamics

*Pushing up to extended length of 1,600 mm*



Unique WEBER-control  
for fine-tuned precision  
handling

Cylinder can be turned under load  
due to rotating pushing head

Piston rods with  
hard chrome-plated finish

Optimal length graduation -  
high power, less weight





# TIPS AND TRICKS THIRD DOOR

Make cuts at marked points



Apply rescue ram



Extend rescue ram

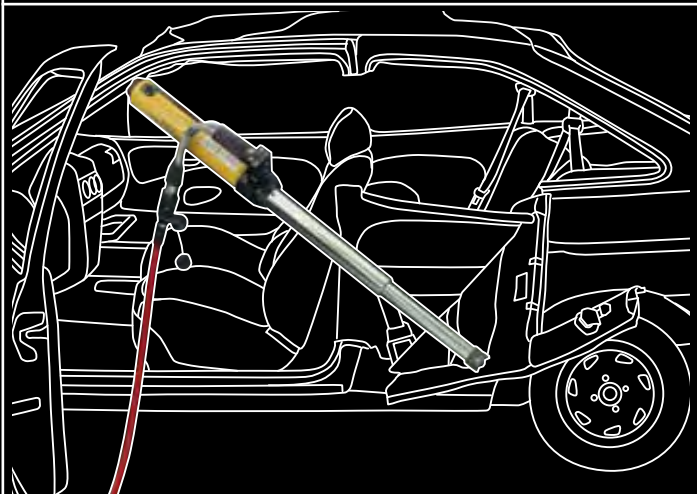

Large rescue opening created



# RESCUE RAMS

## RESCUE RAMS SINGLE-STAGE

	RZ 1 – 850	RZ 2 – 1290	RZ 3 – 1640
Pushing force*	137 kN	137 kN	137 kN
Pulling force*	26 kN	26 kN	26 kN
Closed length	530 mm	750 mm	1,100 mm
Piston stroke	320 mm	540 mm	540 mm
Extended length	850 mm	1,290 mm	1,640 mm
Weight	11.7 kg	16.4 kg	19.4 kg
EN class	R 137/320-12	R 137/540-16	R 137/540-19
Part no.	5933803	5933781	5933765

## TELESCOPIC RESCUE RAMS

	RZT 2 – 600	RZT 2 – 775	RZT 2 – 1170	RZT 2 – 1500
Pushing force*	189.4/99 kN	189.4/99 kN	189.4/99 kN	189.4/99 kN
Closed length	300 mm	395 mm	540 mm	650 mm
Piston stroke	300 mm	380 mm	630 mm	850 mm
Extended length	600 mm	775 mm	1,170 mm	1,500 mm
Weight	9.3 kg	11.5 kg	15.2 kg	18.0 kg
EN class	TR 189/165-99/135-9	TR 189/210-99/170-12	TR 189/360-99/270-15	TR 189/470-99/380-18
Part no.	5936934	5931401	1050149	1050041

## TELESCOPIC RESCUE RAMS XL

	RZT 2 – 1500 XL	RZT 3 – 1310 XL
Pushing force*	269,4/129,5 kN	269,4/129,5/45,4 kN
Closed length	650 mm	480 mm
Piston stroke	852 mm	830 mm
Extended length	1,502 mm	1,310 mm
Weight	20.9 kg	17.2 kg
EN class	TR 269/445-130/407-21	–
Part no.	5932025	5934133

\*according to EN 13204 to 700 bar



# CROSSRAMMER RZ 1-1810

Perfect ram to enlarge a deformed interior and to work inside a vehicle!

- Lightweight and compact
- Body with small diameter
- Large extended length of 1,810 mm



**NEW!**



<b>Pushing force</b>	36.44 kN
<b>Closed length</b>	990 mm
<b>Piston stroke</b>	820 mm
<b>Extended length</b>	1810 mm
<b>EN class*</b>	R36/820-14
<b>Weight</b>	13.9 kg
<b>Part no.</b>	1077052

\*clearance certificate according to EN 13204

## ACCESSORIES

	<b>Weight</b>	<b>Part no.</b>
<b>Base support front</b>	6.0 kg	1824333
<b>Base support back</b>	9.8 kg	1824341
<b>Sill support</b>	10.0 kg	8121737
<b>Rim adapter set back wheel (Base plate,3 rim adapters and carrying case)</b>	19.6 kg	2852144
<b>Rim adapter set back and front wheel (Base plate,3 rim adapters, rim adapter front and carrying case)</b>	30.7 kg	2854082
<b>Chain set for RZ 1-3 and for SP 30/35/35 L</b>	7.4 kg	571407
<b>Chain set for RZ 1-3 and for SP 43 XL/49/60</b>	13.8 kg	2819139
<b>Adapter for chain set 571407 (2 pcs. required)</b>	0.7 kg	3837300
<b>Adapter for chain set 2819139 (2 pcs. required)</b>	0.8 kg	3847900
<b>Accessory set RZ 1,2 and 3 (Different pushing heads with storage box)</b>	6.5 kg	2823306
<b>Extension 250 mm for RZT 2-600 and RZT 2-775</b>	3.4 kg	3864588
<b>Extension 175 mm for RZ 1-850</b>	2.0 kg	1058482
<b>Extension 250 mm for RZ 1-850</b>	2.6 kg	3838579
<b>Extension 320 mm for RZ 1-850</b>	3.0 kg	1062442



# PASSION MEETS DYNAMICS

*The new WEBER RESCUE E/V 70 W hydraulic power units*



Central control unit  
(illuminated)

Dual hose reel, available with hoses in different versions and lengths

Ultra-high pressure hoses 2 x 20 m for either operating your chosen tool on double-speed "turbo" operation or for simultaneous operation of two tools



Large carrying handles

Integrated rewinder

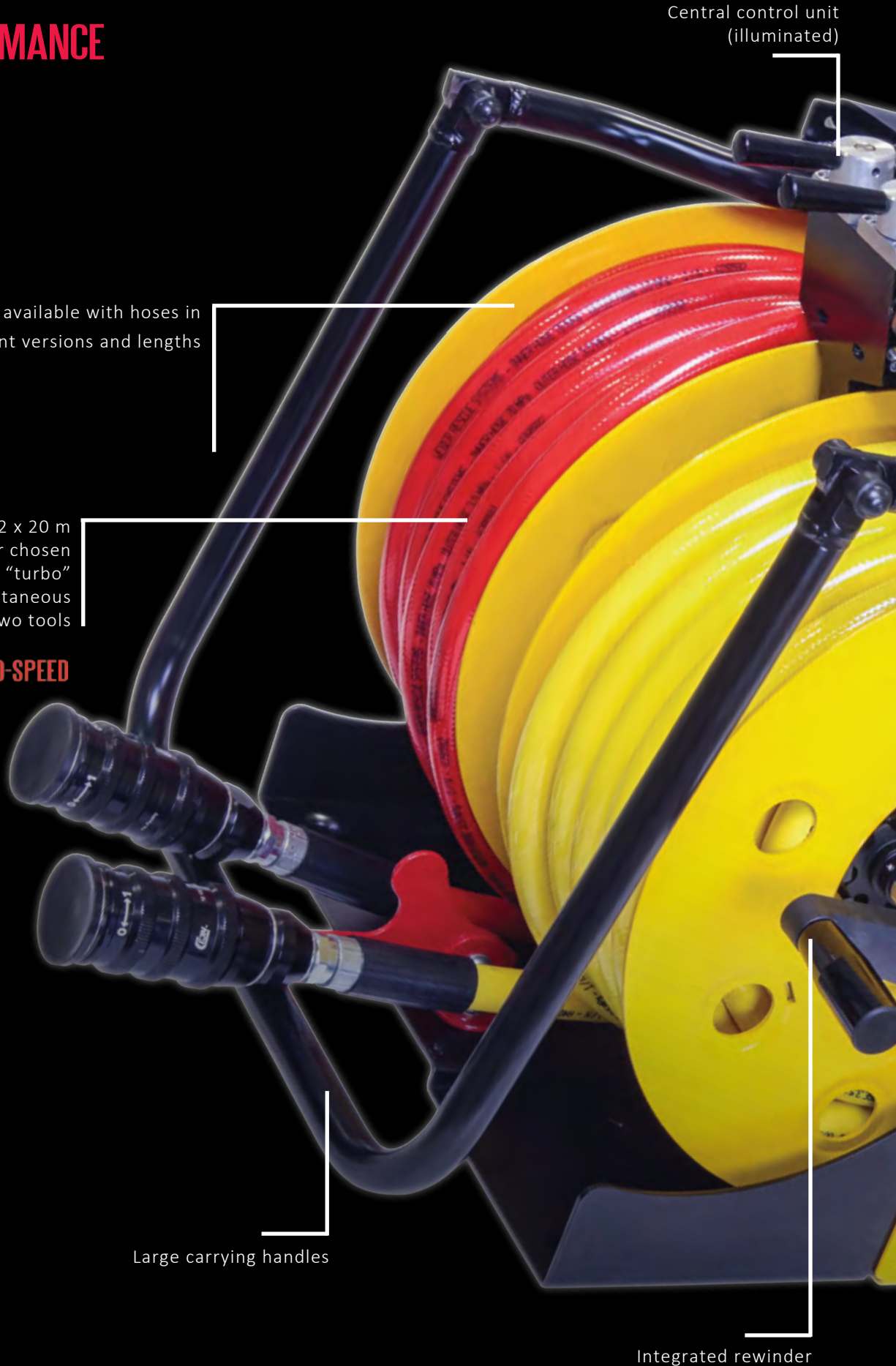



# TEAM *gold*

Power  
meets speed

Integrated tool brackets,  
individually adjustable for all tools

Larger oil volume (6.5 l) for  
simultaneous operation of all tools

Higher operating speed due to new  
high performance pump

Petrol or electric motor

**WEBERRESCUE**  
SYSTEMS

Compact, modern design



# TURBO-SHIFTING

Shift position 1:  
Simultaneous operation

Shift position 2:  
TURBO mode = double speed

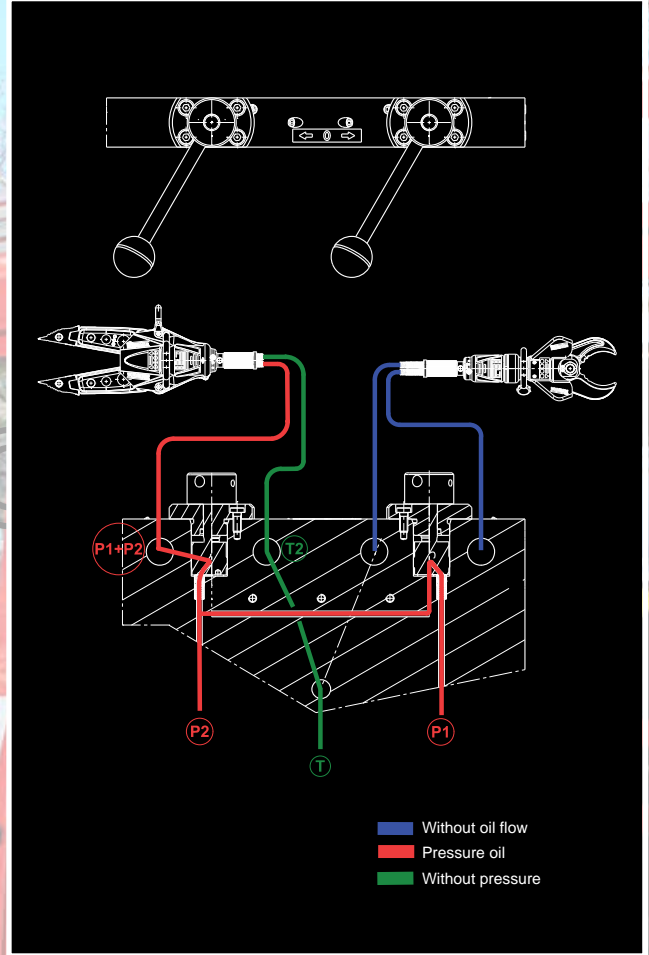
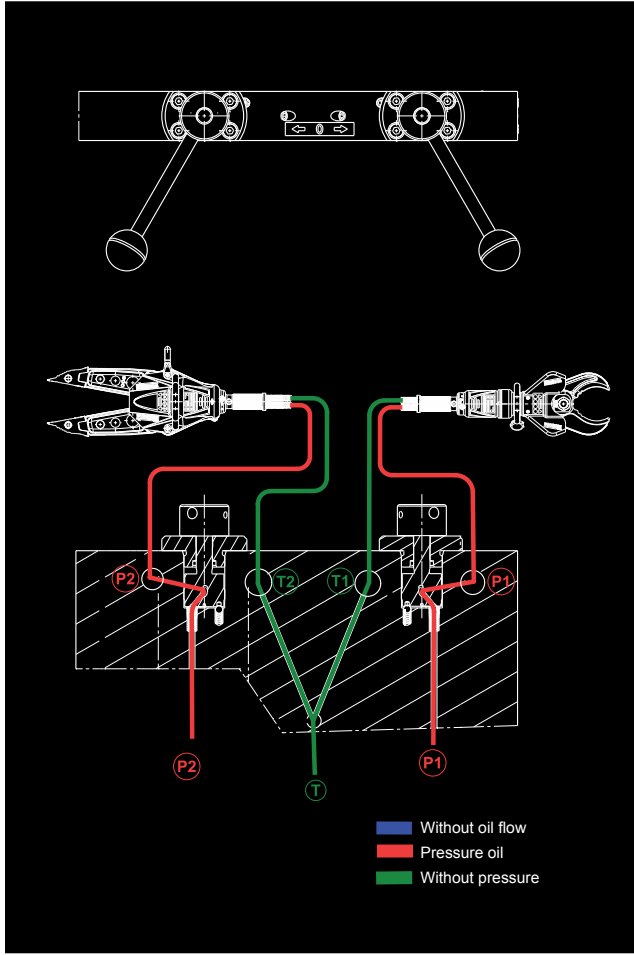

# TURBO-SPEED



# POWER UNITS

E 70 W-SAH 20  
V 70 W-SAH 20

**W** PERFORMANCE

**NEW!**

Motor	E-Motor 230 V, 50 Hz, 2 kW	4-stroke petrol engine, 4 kW
Nominal pressure*	630/700 bar	630/700 bar
Oil volume	6.5 l	6.5 l
Weight	78.5 kg	82.5 kg
EN class	ATO/MTO	ATO/MTO
Part no.	1078718	1078719



E 70 W-SAH 20  
V 70 W-SAH 20  
WITH COAX HOSES

**COAX**

Motor	E-Motor 230 V, 50 Hz, 2 kW	4-stroke petrol engine, 4 kW
Nominal pressure*	630/700 bar	630/700 bar
Oil volume	6.5 l	6.5 l
Weight	74.0 kg	78.0 kg
EN class	ATO/MTO	ATO/MTO
Part no.	1069283	1058332



\*according to EN 13204 to 700 bar

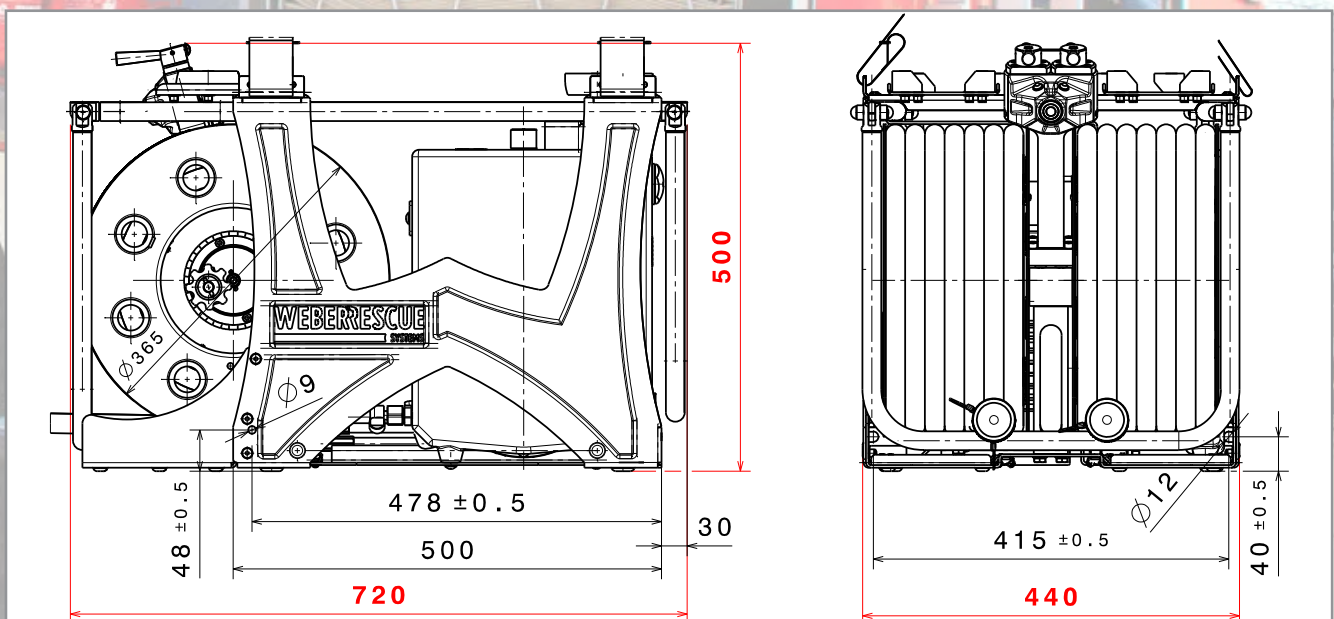

# FULL POWER MEETS MINIMUM SPACE

*Compact power units with ECO technology*

## **TURBO-SPEED**

Operation of 2 tools simultaneously or one tool on "fast" turbo mode (more oil volume for faster working)

Industrial motor



Small, lightweight and flexible, high output – fast working

Will function even when under extreme inclination (up to 30°)

Automatic speed control to reduce noise





# TIPS AND TRICKS RESCUE OPENING

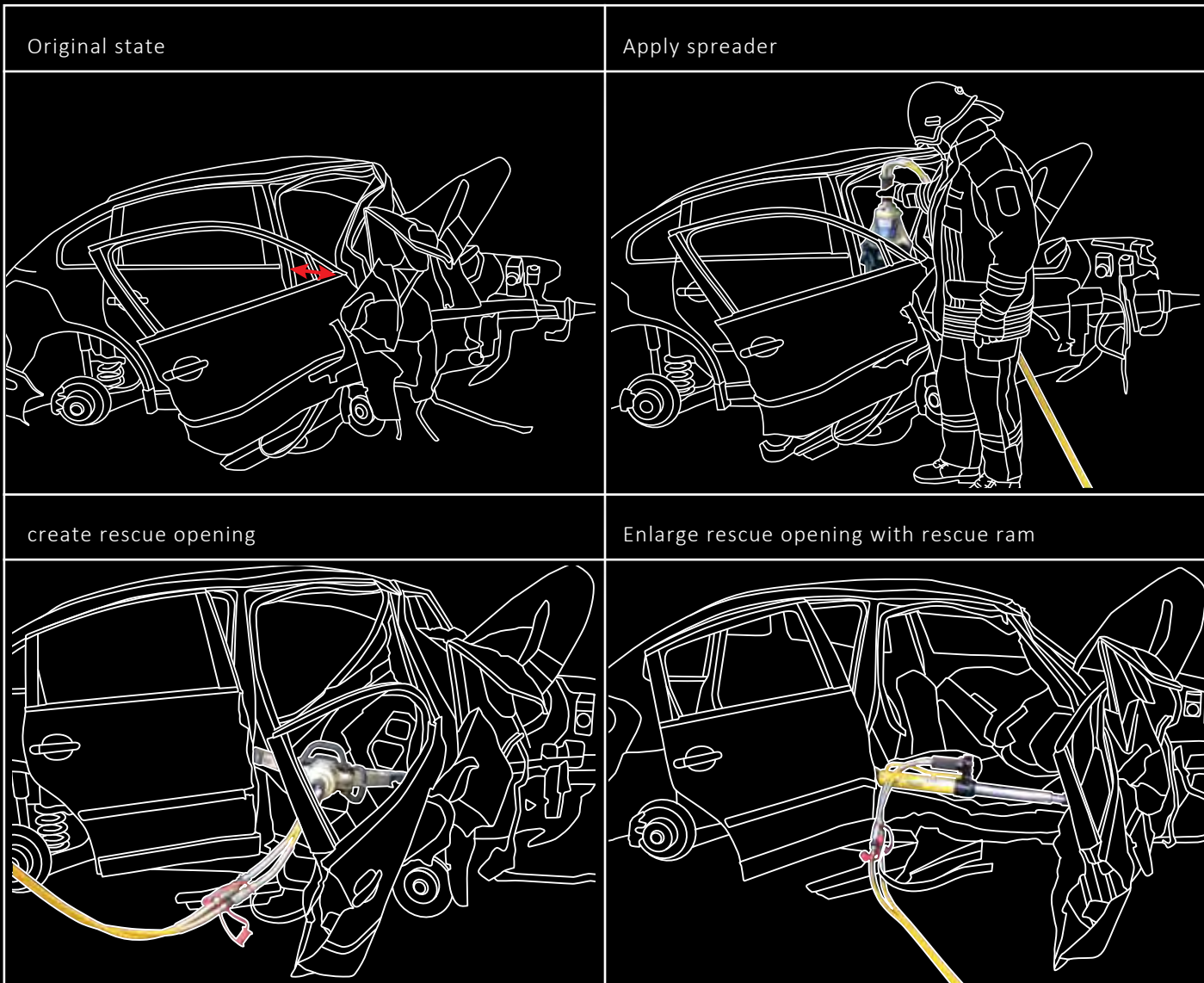

# COMPACT POWER UNITS



## V 400 ECO ECO

	V 400 S	V 400 ECO
Motor	4-stroke petrol engine 1.5 kW	4-stroke petrol engine 1.5 kW
Nominal pressure*	630/700 bar	630/700 bar
Oil volume	2.5 l	2.5 l
Weight	17.3 kg	17.3 kg
EN class	STO	STO
Part no.	5934753	5936853



## V 50 ECO

### V / E 50 S



	V 50 ECO	V 50 S	E 50 S
Motor	4-stroke petrol engine 2.2 kW	4-stroke petrol engine 3.4 kW	E-Motor 230 V, 50 Hz, 1.3 kW
Nominal pressure*	630/700 bar	630/700 bar	630/700 bar
Oil volume	4.0 l	4.0 l	4.0 l
Weight	29.9 kg	31.4 kg	31.0 kg
EN class	ATO/MTO	ATO/MTO	ATO/MTO
Part no.	5935717	5934460	1070365



## E-COMPACT

Motor	E-Motor 230 V, 50 Hz, 1.5 kW
Nominal pressure*	630/700 bar
Oil volume	2.8 l
Weight	12.5 kg
EN class	STO
Part no.	1050354

- Extremely lightweight and flexible
- One connection with very high output
- Small installation dimension



### ECO power

Engine revs are automatically increased when the tool control button is pressed. Returns to idle revs automatically when control button is released.



# MORE COMPACT POWER UNITS...



## V-ECOSILENT

Motor	4-Stroke Petrol Engine 2.2 kW
Nominal pressure*	630/700 bar
Oil volume	2.7 l
Weight	24.9 kg
EN class	ATO/MTO
Part no.	5935318

- Extra silent - only 63.9 dB (A)

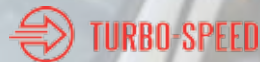

## V-ECOCOMPACT

Motor	4-Stroke Petrol Engine 2.2 kW
Nominal pressure*	630/700 bar
Oil volume	3.8 l
Weight	23.9 kg
EN class	ATO/MTO
Part no.	1060793

- Small, strong, lightweight



\*according to EN 13204 to 700 bar



You can find our battery tools on page 40



# HOSES



## EXTENSION HOSES AND COUPLINGS

- High pressure dual extension hoses
- Filled with oil, fitted with SINGLE couplings

Length	Part no. yellow	Part no. red	Weight
5 m	2847647	2847639	4.3 kg
10 m	2847663	2847655	7.6 kg
15 m	2847680	2847671	9.5 kg
20 m	2847701	2847698	13.0 kg



## COAX HOSES

- COAX design hose (Hose-in-hose-system)
- Filled with oil, fitted with SINGLE couplings
- No twisting possible



Length	Part no. yellow	Part no. red	Weight
5 m	1052602	1052605	3.3 kg
10 m	1052603	1052606	5.5 kg
15 m	1052604	1052607	7.7 kg
20 m	1053457	1053455	10.0 kg



## Comparison common coupling/ SINGLE coupling



- Common coupling:
- 2 actions for coupling
  - Coupling only without pressure possible
  - Pressure relief plug needed

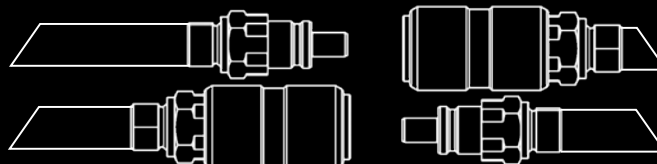

Common coupling can be replaced with SINGLE coupling

- +** SINGLE coupling:
- 1 action for coupling
  - Coupling with pending pressure
  - No need for any kind of pressure relief plug

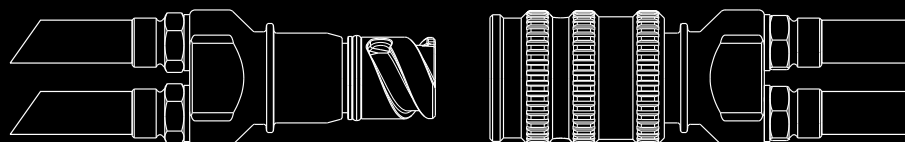



# HOSE REELS

## FREE STANDING DUAL HOSE REEL HF 20 T

- With carrying frame, complete with 2 x 20 m high-pressure hoses
- Both reels can be operated separately, even when the hoses are under pressure
- With two folding handles for rewinding

	Twin hose	COAX-hose
<b>Weight</b>	40.0 kg	34.0 kg
<b>Part no.</b>	5935016	1054768



## FREE STANDING SINGLE HOSE REEL EHF 20 T

- With carrying frame, complete with 20 m high-pressure hose
- Can be operated even when the hose is under pressure
- Folding handle for rewinding

	Twin hose	COAX-Hose
<b>Weight</b>	22.0 kg	18.2 kg
<b>Part no. high pressure hose red</b>	5931932	1054236
<b>Part no. high pressure hose yellow</b>	5932491	1054754
<b>Part no. high pressure hose blue</b>	5932661	1055333
<b>Part no. high pressure hose black</b>	5932980	--



## HOSE PROTECTION

- Additional protection tools pig tail hoses
- KEVLAR material protective coating and duraskin® cover
- For tool control valves with plastic sleeve
- Velcro fastener

<b>Color</b>	black
<b>Length</b>	30 cm
<b>Part no.</b>	8064563

## PROTECTION COVER

- For 5-20 m Hoses
- For protection against abrasion and contamination
- KEVLAR material protective coating and duraskin® cover
- Velcro fastener

Color	red	yellow	blue
<b>Length</b>	4 m	4 m	4 m
<b>Part no.</b>	8051496	8051500	8058024





# THE NEW MOBILITY

## E FORCE 2



Long operating time due to 5.0 Ah capacity (28 V Li-Ion-Battery)

Rocker switch for fine tuned handling even with one hand

LED lights for better view in the working area

Fibre-reinforced case for hardest use

Drive unit retrofittable for E-Force tools Generation 1 and mobile rescue tools

New, efficiency improved drive unit for longer working time and higher operating speed





# NEW BATTERY TOOL SERIES E-FORCE 2



- New housing with efficiency improved drive unit
- Nearly double working time
- Additionally higher operating speed



Sensitive control with clear identification of open and close movement



## BATTERY TOOLS

E-FORCE 2

NEW!

## CUTTERS E-FORCE 2

	RSX 160-50 E-FORCE 2	RSX 180-80 PLUS E-FORCE 2	RSU 200-107 PLUS E-FORCE 2
Opening	160 mm	180 mm	200 mm
Max. cutting force	50 t/493 kN	92 t/903 kN	107 t/1.050 kN
Max. cutting force (round steel bar)	∅ 32 mm	∅ 35 mm	∅ 43 mm
Weight (incl. battery)	18.2 kg	21.4 kg	23.5 kg
NFPA class	A6/B7/C6/D7/E8	A7/B9/C7/D9/E9	A8/B9/C7/D9/E9
Part no.	1077690	1075255	1075262

## COMBI TOOLS E-FORCE 2

	SPS 270 E-FORCE 2	SPS 360 L E-FORCE 2	SPS 370 E-FORCE 2
Spreading force	32 - 591 kN	39 - 783 kN	36 - 783 kN
Max. cutting force	33 t/ 324 kN	50 t/ 491 kN	50 t/ 491 kN
Max. cutting force (round steel bar)	∅ 25 mm	∅ 30 mm	∅ 30 mm
Spreading distance	265 mm	360 mm	370 mm
Pulling width	345 mm	346 mm	346 mm
Weight (incl. battery)	14.2 kg	18.6 kg	19.4 kg
NFPA class	A6/B5/C6/D6/E7	A6/B8/C6/D8/E7	A6/B8/C6/D8/E7
Part no.	1075250	1074458	1077676



**Batteries not  
included in delivery!**



# BATTERY TOOLS



RSU 200-107 PLUS E-FORCE 2



SPS 370 E-FORCE 2



RSX 180-80 PLUS E-FORCE 2



SPS 360 L E-FORCE 2



RSX 160-50 PLUS E-FORCE 2



SPS 270 E-FORCE 2



# BATTERY TOOLS

**E-FORCE 2**

**NEW!**

## Spreaders E-FORCE 2

	SP 35 AS E-FORCE 2	SP 53 BS E-FORCE 2
Spreading force	35 - 171 kN	53 - 421 kN
Closing force	76 kN	100 kN
Spreading distance	600 mm	800 mm
Weight (incl. battery)	18.3 kg	24.0 kg
EN class	AS 35/600-19	BS 53/800-24
Part no.	1075263	1077791



SP 35 AS E-FORCE 2

SP 53 BS E-FORCE 2

## Rescue ram E-FORCE 2

**NEW!**

	RZ 1-910 E-FORCE 2	RZ 2-1360 E-FORCE 2
Pushing force	111.3 kN	108/62 kN
Closed length	542 mm	560 mm
Piston stroke	368 mm	800 mm
Extended length	910 mm	1,360 mm
Weight (incl. battery)	15.7 kg	18.9 kg
Part no.	1075272	1078342



RZ 1-910 E-FORCE 2



RZ 2-1360 E-FORCE 2

**BLACK SERIES**



# SPECIALISED BATTERY TOOLS

**E FORCE 2**

## Power wedge SPK 250 E-FORCE 2

Insertion height	8 mm
Max. lifting height	61 mm
Lifting force	25 t / 245 kN
Weight (incl. battery)	12.6 kg
Part no.	1077812



## Door opener DO 140 E-FORCE 2

Piston stroke	140 mm
Pushing force*	11 t / 105 kN
Weight (incl. battery)	14.3 kg
Part no.	1078140

**NEW!**

## Concrete crusher BC 250 E-FORCE 2

Opening	250 mm
Closing force	11 t/109 kN
Weight (incl. battery)	21.5 kg
Part no.	1077721

**BLACK SERIES**

## Accessories

Accessories	Weight	Part no.
Mechanical rescue ram RZM 740 for SPS 270 E-FORCE 2 and SPS 360 L E-FORCE 2	6.9 kg	1056478
Chain set for SPS 270 E-FORCE 2	7.4 kg	571407
for SPS 360 L / SPS 370 E-FORCE 2	13.8 kg	2819139
for SP 35 AS / SP 53 BS E-FORCE 2	13.8 kg	571415
Pulling device (2 pcs. required)		
for SPS 270 E-FORCE 2	1.4 kg	2096617
for SPS 360 L E-FORCE 2	1.4 kg	2835746
for SPS 370 E-FORCE 2	1.4 kg	2836033
Extension for RZ 1-910 E-FORCE 2		
175 mm	2.0 kg	1058482
250 mm	2.6 kg	3838579



# BATTERY POWER UNITS



## B-COMPACT

- The advantages of the successful power unit E-COMPACT in combination with battery power!
- Extremely lightweight and flexible
- One connection with very high output
- Small stowage dimension
- Ability to connect 2 batteries
- Permanent operation by using a power supply
- Delivered without battery

Nominal pressure	630/700 bar
Oilvolume	2.8 l
Weight (oil-filled, incl. battery)	11.9 kg
Part no.	1068081



## BATTERY PAC

- Extremely lightweight hydraulic power unit with 28 V battery drive
- Back-pack solution with wide and comfortable belts for safe fit
- Nominal pressure and tank volume constructed to drive all WEBER rescue tools (including XL rescue rams)
- Supplied without batteries as standard, 2nd battery optional to double the operation time (10 Ah)

Nominal pressure	630/700 bar
Oilvolume	2.5 l
Weight (oil-filled, incl. battery)	10.0 kg
Part no.	1067360





## ACCESSORIES BATTERY TOOLS

	Weight	Part no.
Spare battery 28 V / 3 Ah	1.0 kg	1053785
Spare battery 28 V / 5 Ah	1.0 kg	1075189
Battery pouch for one battery (without belt)	0.2 kg	1056921
Belt for battery pouch	0.1 kg	1056920
On-vehicle charger (without plug)	1.0 kg	1060423
Mains charger 110 V for one battery	0.8 kg	1054099
Mains charger 230 V for one battery	0.8 kg	1054097
Power supply 230 V	4.0 kg	1060422
Power supply 110 V	5.0 kg	1060426
Transport bag for SPS 270 E-FORCE 2 or SPS 360 L E-FORCE 2	1.8 kg	1058128



Battery compatible  
with MILWAUKEE  
battery-operated saws!

## BATTERY SAWS AND ACCESSORIES

	Weight	Part no.
MILWAUKEE Reciprocating saw V 28 SET Recip saw tool, 2 batteries 28 V / 3 Ah, mains charger 230 V for one battery, carrying case	9.0 kg	1054063
MILWAUKEE Reciprocating saw tool V 28 without battery, mains charger and carrying case	3.0 kg	1059177
Blade EXTRICATION SET 4 pcs blades 150 mm 6 pcs blades 230 mm	0.4 kg	1078478
Blade SET DIN 5 pcs blades wood / plastic 230 mm 5 pcs blades wood 230 mm 5 pcs blades wood with nails 150 mm 5 pcs blades for metal 230 mm	0.3 kg	1059189 1059182 1059183 1059184 1059186
Blade SET VU 5 pcs blades for metal 150 mm 5 pcs blades for metal 230 mm 5 pcs blades universal 200 mm	0.2 kg	1059190 1059185 1059186 1059187
MILWAUKEE Metal cutting circular saw V 28 SET, 2 batteries 28 V / 3 Ah, mains charger 230 V for one battery, carrying case	9.2 kg	1054064
MILWAUKEE Metal circular cutting saw V 28 without battery, mains charger and carrying case	3.2 kg	1059178
Circular saw blades	0.2 kg	1059188



*Milwaukee*

# LIGHT TOOLS

- Extremely lightweight and versatile
- Rescue tools for disasters, such as earthquakes and building collapses
- All tools weigh less than 10 kg
- All tools are matched to the power unit
- One-handed operation possible with tools
- Special transport system for usage in difficult terrain (e.g. helicopter transport)

**NEW!**

## Cutters S 140-26 light

Opening	140 mm
Max. cutting force*	255 kN
Max. cutting force (round steel bar)	25 mm
EN class	AC-115-D-8
NFPA class	A5/B3/C3/D6/E7
Weight	7.9 kg
Part no.	1075652



S 140-26 light

## Combi tools SPS 270 light

Spreading distance	270 mm
Max. cutting force*	bis 48 t / 471 kN
Max. cutting force* (round steel bar)	25 mm
Pulling force	52 kN
EN class	E
NFPA class	A6/B6/C6/D7/E7
Weight	8.9 kg
Part no.	1075680



SPS 270 light

## Rescue ram light

	RZ 1-465 light	RZ 1-580 light
Pushing force*	111.3 kN	111.3 kN
Closed length	317 mm	395 mm
Piston stroke	150 mm	185 mm
Extended length	467 mm	580 mm
EN class*	R 111/150-7	R 110/185-9
Weight (incl. battery)	6.9 kg	8.7 kg
Part no.	1075651	1075944



RZ 1-465 light





**We also offer an extensive range of pneumatic solutions!**



**Power unit V 400 light**

Motor	4-stroke petrol engine HONDA 1.2 kW
Nominal pressure	700 bar
Oil volume	1.5 l
Weight (oil-filled)	14.2 kg
Part no.	1075621

# STROKE MEETS CONTROL

*Tools for lifting, pushing and moving of loads*



Save transport and storage



Hydraulic door opener for rapid forcible entry and lifting of concrete slabs, steel beams etc.



Hand pump for independent operations



# TIPS AND TRICKS

## DOOR OPENING, FROM ABOVE

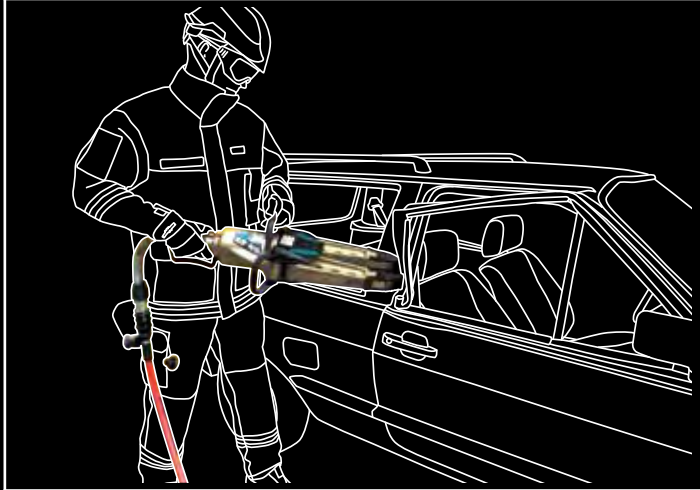
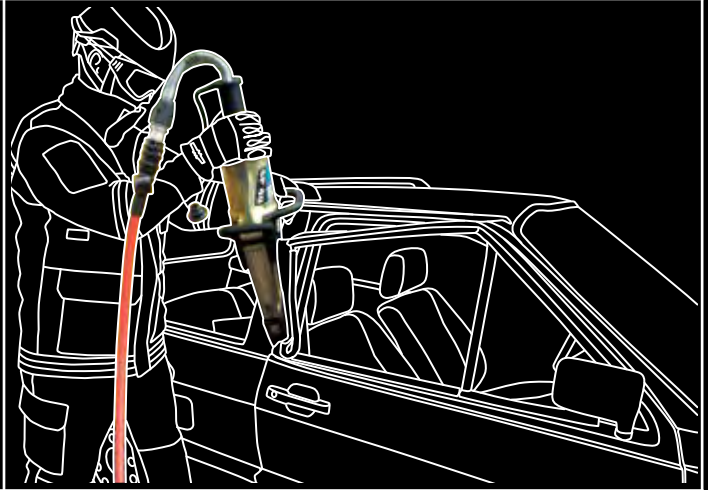
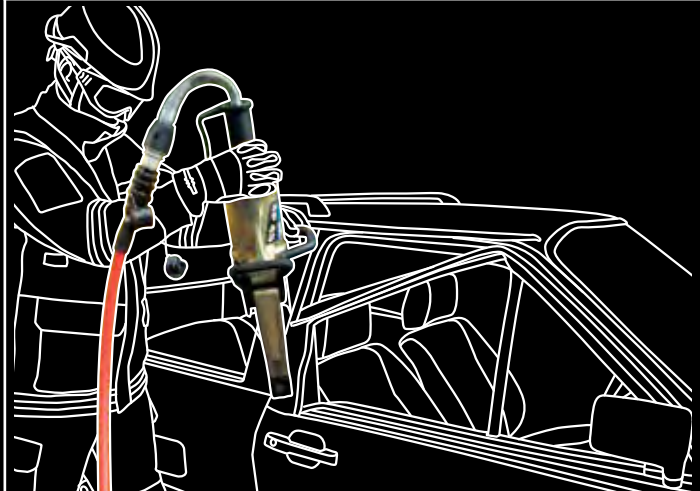
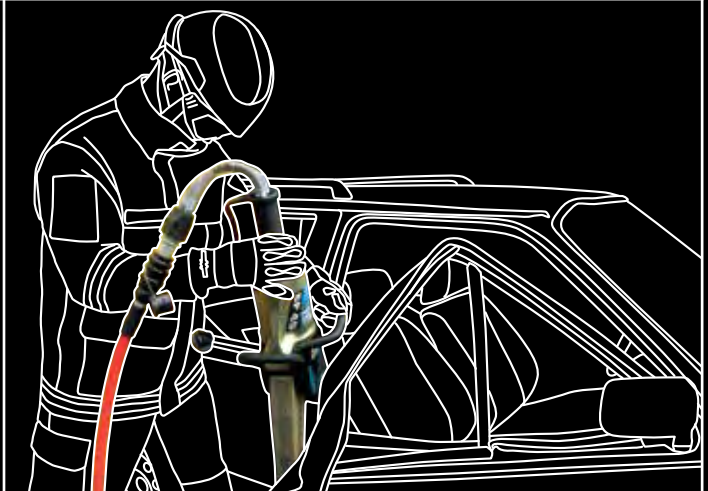
<p>Bend window frame open</p>	<p>Apply spreader from above in gap</p>
	
<p>During closing the spreader slides in (gravity)</p>	<p>Re-apply the spreader</p>
	



# LIFTING EQUIPMENT

## LIFTING SETS

- Single-acting hydraulic cylinders
- Lifting power 137 kN
- Including hand pump and accessories
- DIN 14800



	Lifting set 1	Lifting set 2
<b>No. of parts</b>	18	13
<b>No. of cases</b>	2	1
<b>Weight</b>	77.0 kg	51.0 kg
<b>Part no.</b>	5933552	5933544

Picture: Lifting set 2

## DOOR OPENING KIT

- For rapid forcible entry
- For lifting heavy objects (concrete slabs, steel beams etc.)
- Including hand pump, hose, door opener and transport case

<b>Weight</b>	16.0 kg
<b>Part no.</b>	1075344



## DOOR OPENER SINGLE ACTION

<b>Pushing force</b>	114.5 kN
<b>Piston stroke</b>	120 mm
<b>Weight</b>	7.1 kg
<b>Part no.</b>	1075922

\*according to EN 13204 to 700 bar



## HYDRAULIC LIFTER SBH 15-255

- Precise hydraulic lifting and lowering
- Minimal set-up time
- Control unit MSE required
- EN 13204 and NFPA 1936 certified

Max. lifting force	148 kN
Max. lifting force claw	100 kN
Insertion height	39.5 mm
Stroke	255 mm
Weight	20.9 kg
Part no.	2839075



Connection lifter/MSE through extension hoses or hose reel with couplings without quickstop

## MOBILE CONTROL UNIT MSE 15-255

- simultaneous and independent operation of two lifters (1 pressure connection per lifter required)
- Safety steering according DIN 14751



Weight	8.6 kg
Part no.	2839440

## BÜFFEL B 5 AND B 10

	B 5	B 10
Lifting force	5,000 kg	10,000 kg
Closed height	660 mm	800 mm
Piston stroke	280 mm	350 mm
Weight	28.2 kg	38.5 kg
Part no.	1013149	198471

## ACCESSORIES

	B 5	B 10
Spherical base	4133323	4129881
Square base	4133315	4129873
Bearing plate		32255



# SPEED MEETS SAFETY

*The improved stabilisation system STAB-FAST MK2*

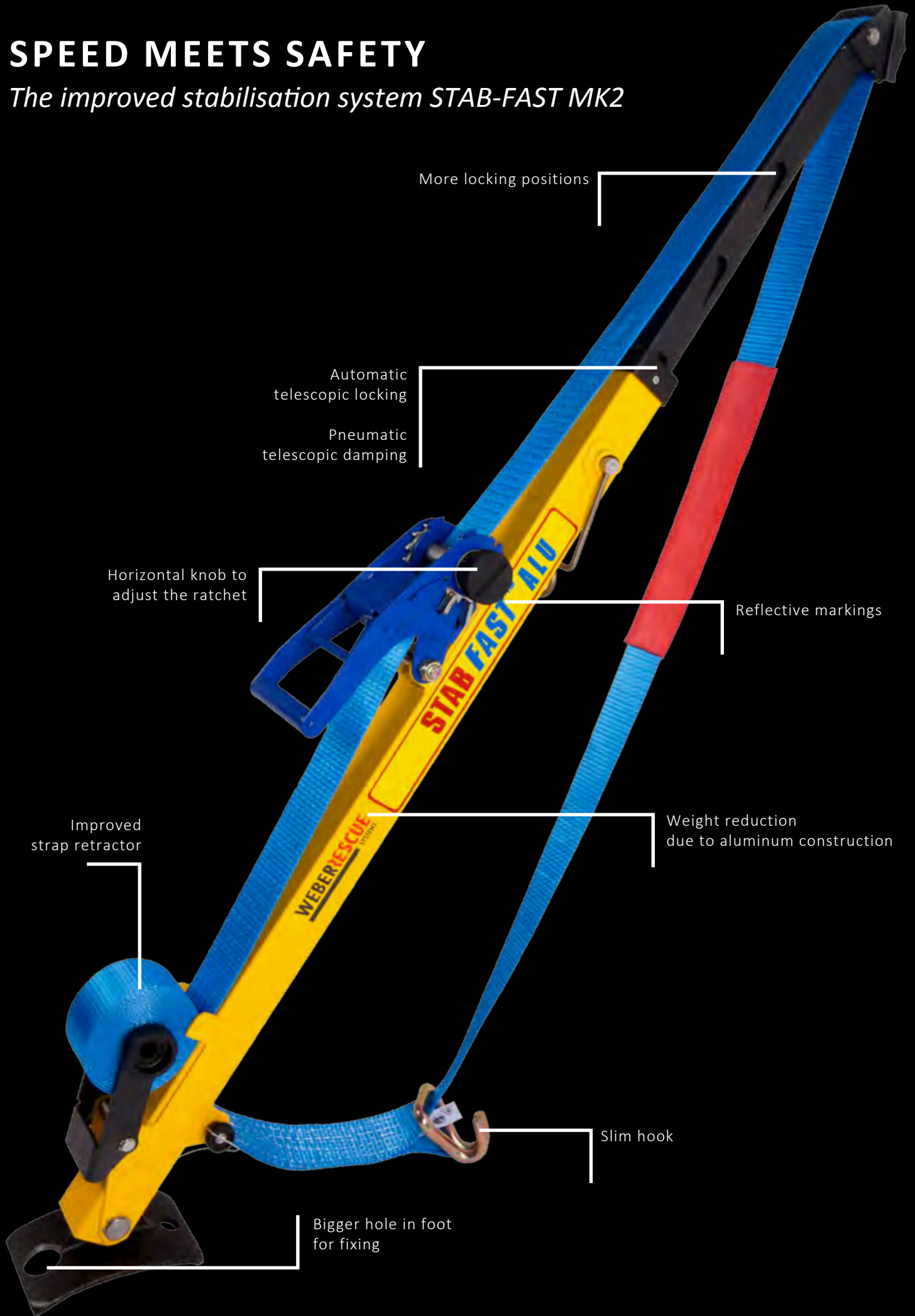

More locking positions

Automatic telescopic locking

Pneumatic telescopic damping

Horizontal knob to adjust the ratchet

Reflective markings

Improved strap retractor

Weight reduction due to aluminum construction

Slim hook

Bigger hole in foot for fixing



# TIPS AND TRICKS

## PULLING STEERING WHEEL

Strike a hole into the windscreen

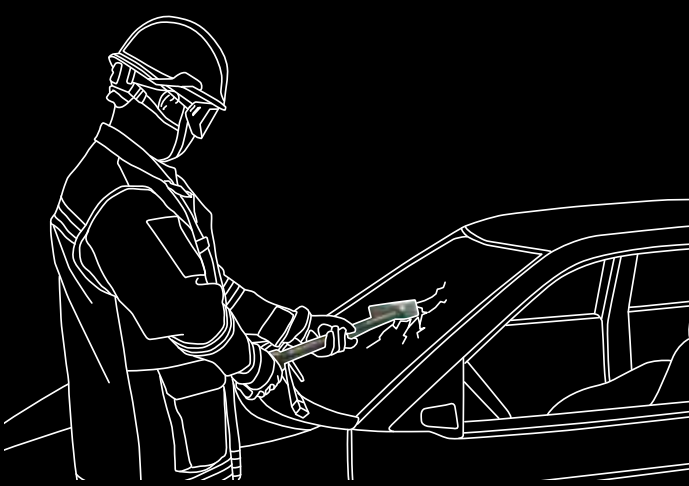

Place a chain around the steering wheel and pull it through the windscreen

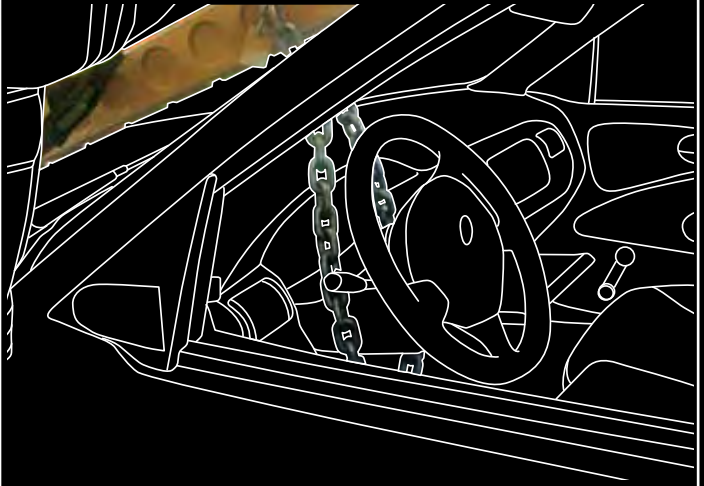

Position suitable timber piece



Apply spreader and pull steering wheel upwards

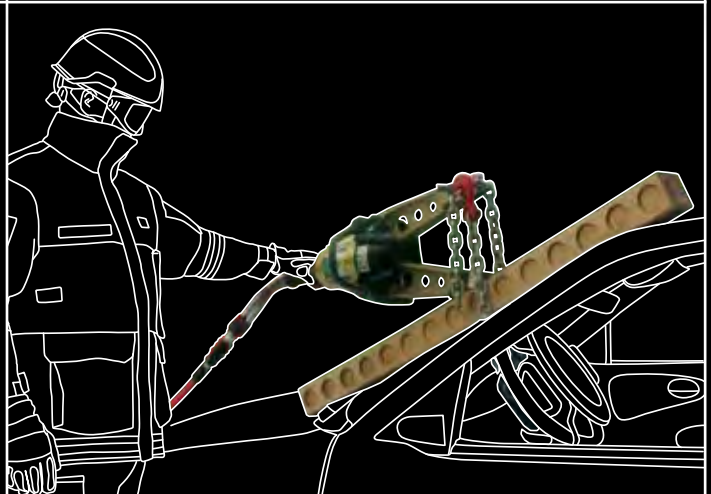



**The new STAB-FAST ALU!!**  
**Lighter due to aluminium construction**  
**Improved knife**

# STABILISATION

## STAB-FAST ALU

- TÜV and CE certified
- Easy, versatile and safe system
- Quick and easy installation

**NEW!**



STAB FAST ALU



STAB FAST ALU Basic



STAB FAST ALU XL

	STAB-FAST ALU	STAB-FAST ALU Basic	STAB-FAST ALU XL
<b>Content</b>	3 struts, hook blade, wedge and 2 transport bags	2 struts, hook blade and transport bag	2 struts, hook blade and transport bag
<b>Closed Length</b>	1,070 mm	1,070 mm	1,500 mm
<b>Extended Length</b>	1,720 mm	1,720 mm	2,500 mm
<b>Weight per strut</b>	7.2 kg	7.2 kg	10.3 kg
<b>Maximum load in longitudinal direction of strut</b>	1,500 kg	1,500 kg	2,500 kg
<b>Length of strap</b>	5,000 mm	5,000 mm	10,000 mm
<b>Bag size</b>	1,100 x 300 x 120 mm	1,100 x 300 x 120 mm	1,600 x 500 x 180 mm
<b>Weight</b>	33.0 kg	19.0 kg	30.0 kg
<b>Part no.</b>	1078418	1078419	1078420



# STABILISATION

## STAB-PACK

- To stabilise the vehicle simply and precisely
- Safety due to easy handling
- Adjustable by two integrated wood wedges
- Safety due to large footprint

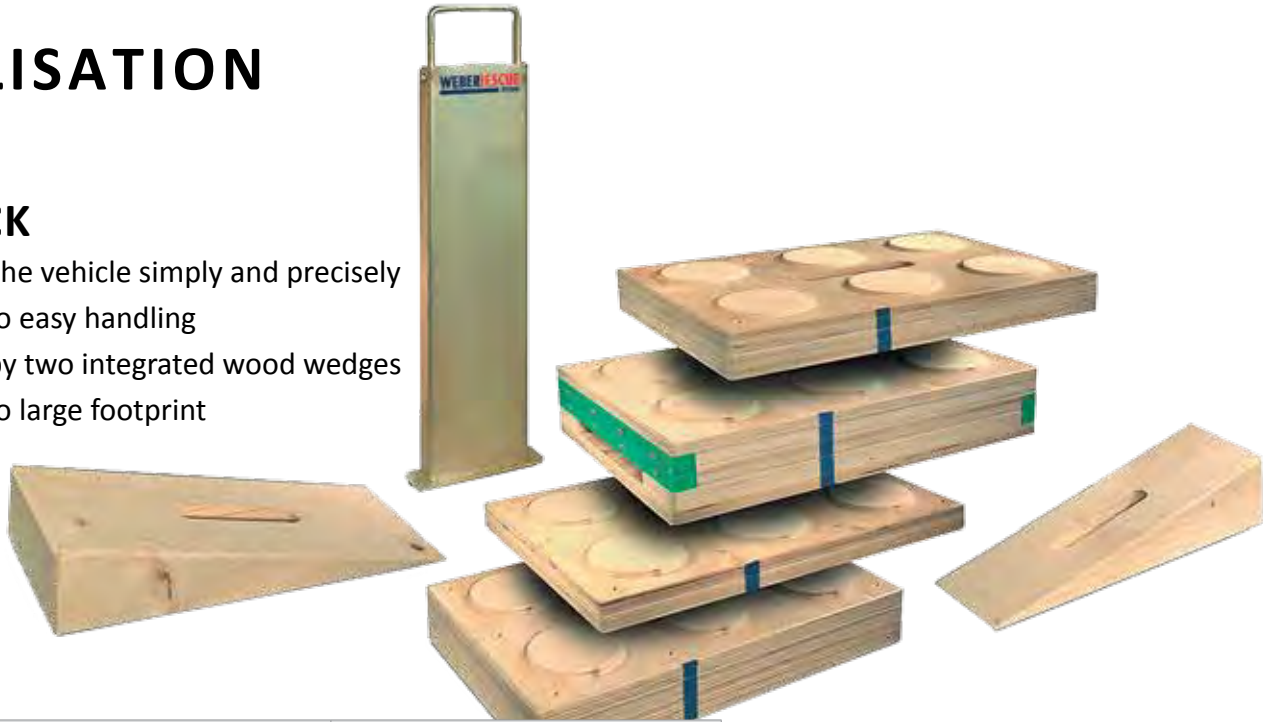

	STAB-PACK	STAB-PACK-SET
<b>Dimension</b>	270 x 180 x 335 mm	600 x 400 x 320 mm (4 pcs. in Eurobox)
<b>Weight</b>	8.6 kg	38.0 kg
<b>Part no.</b>	8044406	1052771





# MORE STABILISATION...

## STAB-LOCK-SET

- Water-proofed bonded beech plywood
- Similar to the Lego system
- Compatible to STAB-PACK system

Set	Dimensions	Weight	Anzahl
<b>Eurobox</b>	600 x 400 x 320 mm	3.3 kg	1
<b>Baseplate 4 x 6</b>	540 x 360 x 36 mm	4.9 kg	1
<b>Wedge</b>	230 x 90 x 60 mm	1.5 kg	4
<b>Top 2 x 3</b>	270 x 185 x 22 mm	1.3 kg	2
<b>Top 2 x 3 s</b>	270 x 185 x 22 mm	1.1 kg	2
<b>4 square 2 x 3</b>	270 x 185 x 95 mm	3.0 kg	1
<b>4 square 2 x 6</b>	540 x 185 x 95 mm	6.4 kg	1
<b>4 square 1 x 3</b>	270 x 95 x 95 mm	1.5 kg	1
<b>4 square 1 x 3 s</b>	270 x 95 x 95 mm	1.4 kg	1
<b>4 square 1 x 6</b>	540 x 95 x 95 mm	3.1 kg	1
<b>4 square 1 x 6 s</b>	540 x 95 x 95 mm	3.0 kg	1
<b>Set-Nr. 1052770</b>		30.5 kg	

## ADDITIONAL PARTS STAB-LOCK

Typ	Dimensions	Weight	Part no.
<b>4 square 1 x 9</b>	810 x 95 x 95 mm	4.4 kg	1052589
<b>4 square 2 x 9</b>	810 x 185 x 95 mm	8.6 kg	1051848
<b>4 square 1 x 12</b>	1,080 x 95 x 95 mm	5.4 kg	1052591
<b>4 square 2 x 12</b>	1,080 x 185 x 95 mm	11.4 kg	1051849
<b>4 square 1 x 15</b>	1,350 x 95 x 95 mm	7.4 kg	1052592
<b>4 square 2 x 15</b>	1,350 x 185 x 95 mm	14.8 kg	1051850
<b>4 square 1 x 18</b>	1,620 x 95 x 95 mm	9.0 kg	1052593
<b>4 square 2 x 18</b>	1,620 x 185 x 95 mm	17.2 kg	1051851



STAB-LOCK 2x3



STAB-LOCK 1x6s



STAB-LOCK Wedge



STAB-LOCK 1x12



STAB-LOCK 2x18



## STAB-FIX

- Recycled PE
- Durable and shatterproof
- Oil- and chemical resistant
- Maximum load capacity up to 110 kg/cm<sup>2</sup>
- No slipping because of pyramid design

Typ	Dimensions	Weight	schwarz	gelb
<b>Chock</b>	640 x 140 x 280 mm	7.4 kg	8066140	8137226
<b>Slide Step Chock</b>	620 x 170 x 275 mm	10.0 kg	1067933	1068551
<b>Block 25</b>	230 x 230 x 25 mm	1.4 kg	8063818	8137170
<b>Block 50</b>	230 x 230 x 50 mm	2.3 kg	8063826	8137188
<b>Block 75</b>	230 x 230 x 75 mm	3.4 kg	8063834	8137196
<b>Wedge 75</b>	215 x 75 x 80 mm	0.7 kg	3191796	8137218
<b>Wedge 150</b>	215 x 150 x 80 mm	1.3 kg	3191800	8137200
<b>4 square 100</b>	100 x 100 x 450 mm	3.1 kg	8137242	8137234
<b>4 square 150</b>	150 x 150 x 600 mm	9.0 kg	8138575	8138494
<b>Bag for 100</b>		0.5 kg		8137250

## STAB-FIX 4 SQUARE SET

- 9 plastic parts within one set
- With transport bag

<b>Stab-Fix 4 square 100 yellow</b>	3 pcs.
<b>Stab-Fix 4 square 100 black</b>	6 pcs.
<b>Bag 300 x 300 x 450 mm</b>	1 pcs.
<b>Weight</b>	28.4 kg
<b>Part no.</b>	8139342

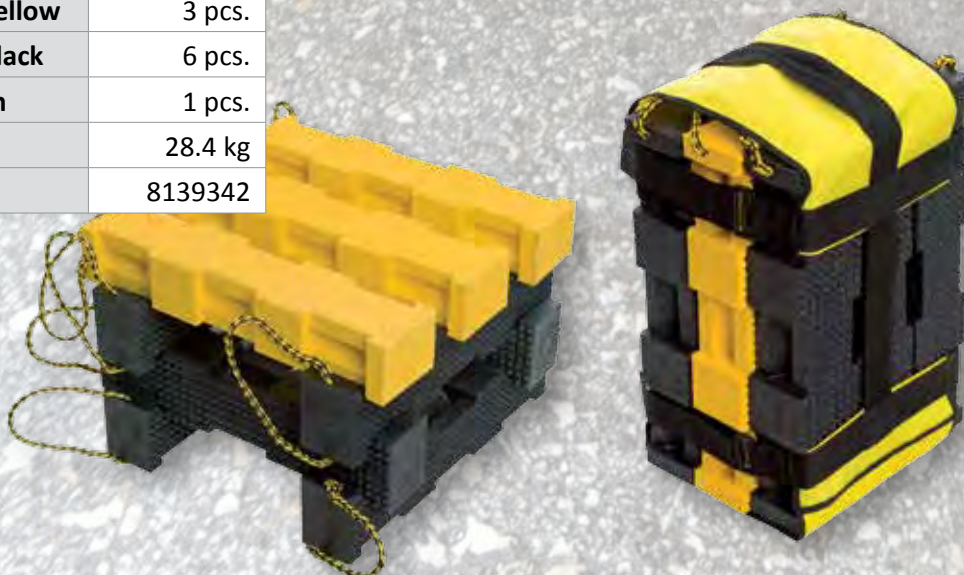



# STANDARD MEETS EXTRA

*Useful accessories for the rescue operation*

Post protector with velco strips

Ideal supplement to the BASIC protective pads  
Designed for modern vehicles and new rescue techniques

Material CORDURA 200  
with 6 magnets each

Hydrophobic outside material  
Inside is resistant against cuts  
Washable

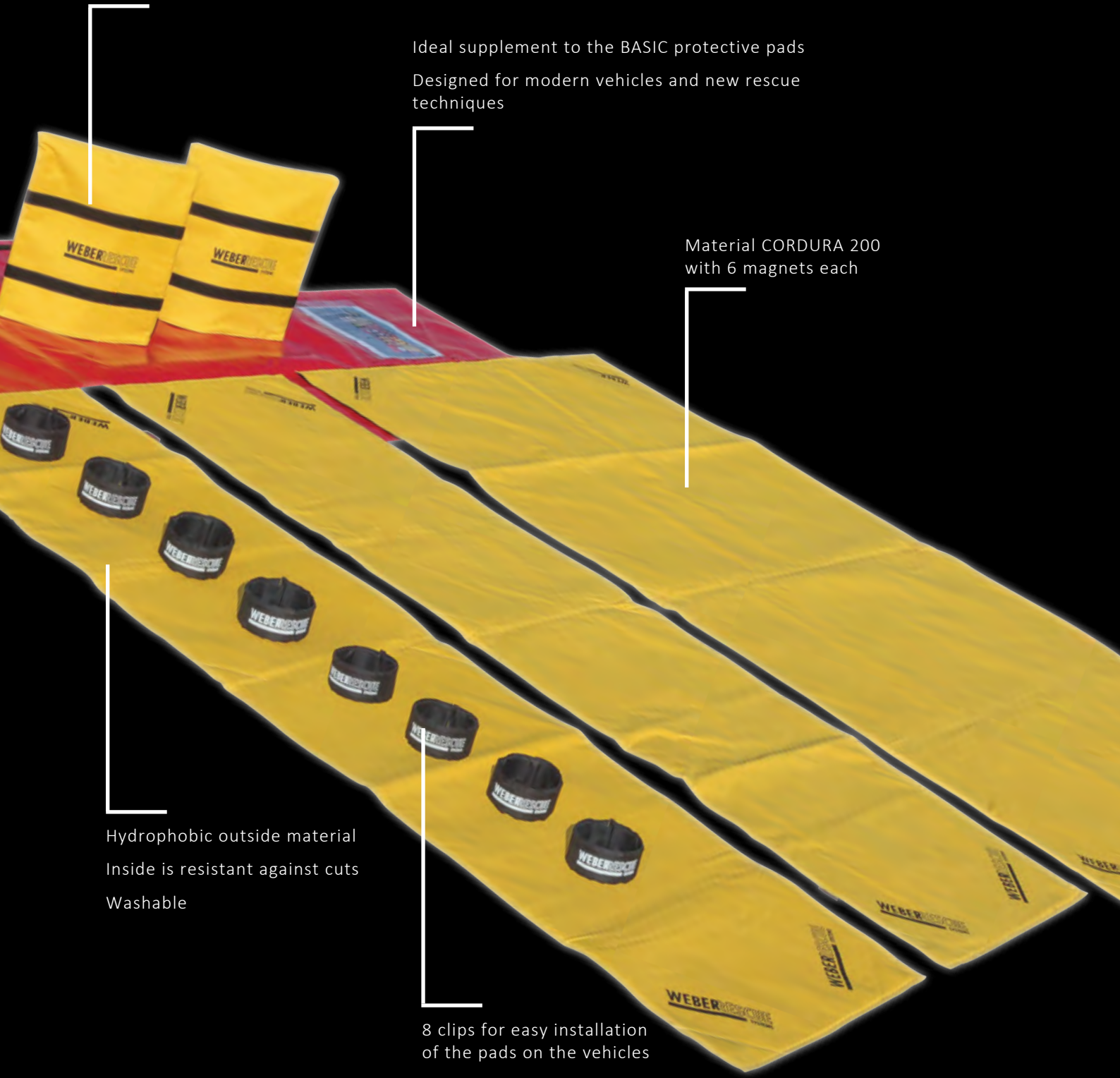

8 clips for easy installation  
of the pads on the vehicles





# TIPS AND TRICKS

## ROOF SECTIONING

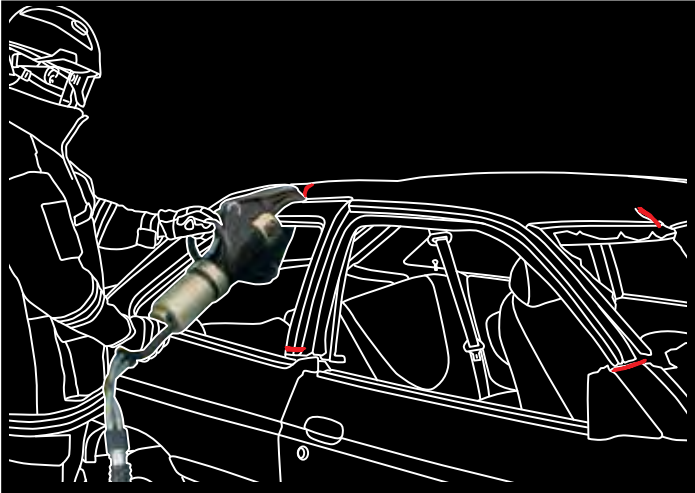
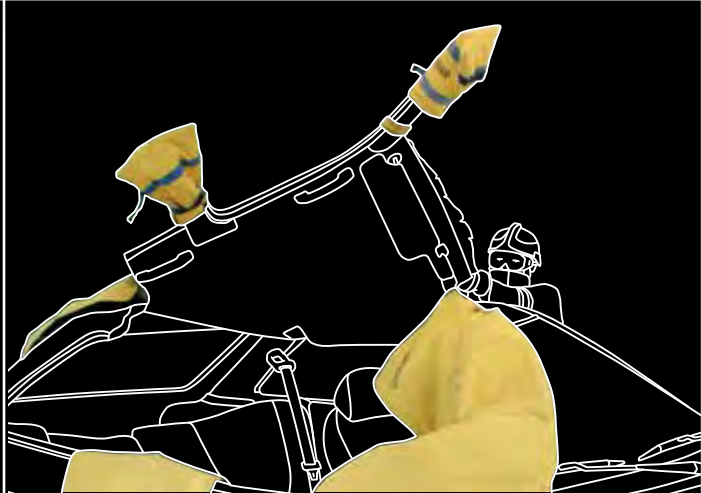
<p>Mark cutting points</p>	<p>Remove glass between the cutting points</p>
	
<p>Cut at cutting points</p>	<p>Open roof</p>
	





# ACCESSORIES

## GLASS-EX AND CENTRE PUNCH

- To remove laminated windscreens
- Including centre punch to remove safety glass

	Weight	Part no.
<b>Glas-Ex</b>	1.5 kg	8114161
<b>Centre punch</b>	0.06 kg	8027676
<b>Replacement blade</b>		8032858



## PROTECTION SHIELD

- Two different sizes and forms – multifunctional use
- Transparent and flexible

<b>Triangle, flexible – PVC with 2 yellow grabbing hangers Size 600 x 400 x 7 mm</b>	1.2 kg
<b>Rectangle, flexible – PVC with 3 yellow grabbing hangers Size 600 x 400 x 7 mm</b>	2.1 kg
<b>Weight total</b>	3.3 kg
<b>Part no.</b>	8136360



## GLASS MANAGEMENT

- Glass-Ex, centre punch and rescue knife
- Adhesive tape dispenser and protective goggles
- Two pieces rescue foil and prying tool
- In a case with foamed inlay

<b>Dimensions</b>	605 x 402 x 132 mm
<b>Weight</b>	5.8 kg
<b>Part no.</b>	1080917



## PATIENT PROTECTION PAD PAT-SAFE

- Flexible, see-through and robust patient protection
- Material CORDURA
- Removable window out of flexible Polyglas 0,3 mm
- With a transport bag

<b>Dimensions</b>	1,600 x 2,000 mm
<b>Weight</b>	1.5 kg
<b>Part no.</b>	1079078
<b>Replacement window</b>	
<b>Dimensions</b>	1,000 x 2,000 mm
<b>Weight</b>	0.6 kg
<b>Part no.</b>	1079079





# ACCESSORIES

## ROUGH EDGE PROTECTIVE PADS, ROUGH EDGE PROTECTIVE PADS UPGRADE AND PLUS



Rough edge protective pads		Rough edge protective pads UPGRADE	
Packing Dimensions	700 x 500 x 95 mm	Packing Dimensions	700 x 500 x 160 mm
4 x column protection, with 2 hook-and-loop tape per pad	300 x 350 mm	2 x column protection, with 2 hook-and-loop tape per pad	350 x 400 mm
2 protection blankets, with 4 magnets per blanket	650 x 650 mm	2 protection blankets, with 4 magnets per blanket	400 x 200 mm
1 protection blanket, with 6 magnets	1,650 x 650 mm	1 protection blanket, with 6 magnets	1,100 x 2,000 mm
Weight	7.8 kg	Weight	8.6 kg
Part no.	8135517	Part no.	1078945

**8 WEBER-Clips for fixation included!**

Rough edge protective pads PLUS consisting of:		WEBER-Clip individually	
Rough edge protective pads and rough edge protective pads UPGRADE		1078944	
Weight	16.4 kg		
Part no.	1078947		

## PATIENT STABILIZATION SYSTEM PAT-STAB

Multi-useable

- Rescue blanket
- Respiator emergency kit
- Emergency trousers
- Shaft rescue
- For stabilization of patient in side position
- Special applications

**NEW!**

Dimensions	2,200 x 750 mm
Weight	11.3 kg
Part no.	1078942

# ACCESSORIES

## HALLIGAN TOOL

- Best accessory for technical rescue
- Available as metal cutter or prying tool
- Different sizes for flexible use
- Various applications
- Handle with nonslip surface

With prying head			
Length	30" - 762 mm	36" - 914 mm	42" - 1,066 mm
Weight	5.5 kg	5.8 kg	5.9 kg
Part no.	8053529	8053537	8053790
With metal cutting head			
Length	30" - 762 mm	36" - 914 mm	
Weight	5.0 kg	5.7 kg	
Part no.	8052700	8052719	

## BASE SUPPORT AND SILL SUPPORT

- Ideal addition to rescue rams
- For supporting rescue ram in centre channel and on door sills
- Prevents slipping of the rescue ram

	Weight	Part no.
Base support front	6.0 kg	1824333
Base support back	9.8 kg	1824341
Sill support	10.0 kg	8121737

Base support back

Sill support

Base support front



# ACCESSORIES

## RESCUE PLATFORM

- Solid aluminium construction
- Adjustable ladders
- Safe adjustment with arresting bolts in 265 mm steps
- Rails equipped with extensions, individually adjustable in 30 mm steps
- Complies to DIN 14830

<b>Packing dimensions</b>	1,050 x 1,790 x 280 mm
<b>Weight</b>	51.0 kg
<b>Part no.</b>	1057597



Find information about our  
Truck rescue training (TRT)  
on page 66

## TRUCK CAGE SAFETY SYSTEM

- Ratchet with stitched-on lashing strap and eye-clamp
- Lashing strap length 10.0 m
- 2 rim clamps
- 2 x round sling length 3.0 m with 2.0 m hose
- Including suitcase

<b>Dimensions</b>	440 x 135 x 350 mm
<b>Weight</b>	8.0 kg
<b>Part no.</b>	8055416

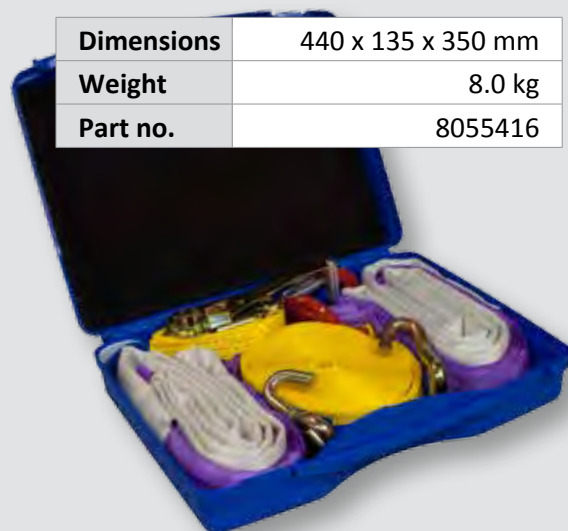

## AIRBAG PROTECTION OCTOPUS

- Suitable for all types of cars and trucks
- Lightweight

<b>Airbag protection cars driver side</b>	
<b>Weight</b>	1.7 kg
<b>Part no.</b>	8046158
<b>Airbag protection cars passenger side in bag</b>	
<b>Weight</b>	3.8 kg
<b>Part no.</b>	8046166
<b>Airbag protection trucks driver side in bag</b>	
<b>Weight</b>	0.8 kg
<b>Part no.</b>	8046204





## ACCESSORIES

### RIM ADAPTERS

- Ideal addition to rescue rams to be used on lorries and buses
- With carrying case

	Weight	Part no.
Rim adapters back wheel	19.6 kg	2852144
Rim adapter set back and front wheel	30.7 kg	2854082

### UNIVERSAL FASTENING FOR RESCUE TOOLS

- Individual fastening of rescue tools in the vehicle
- Can be fastened horizontally or vertically
- Space saving and flexible
- Rapid fastening

Fastening for:	Weight	Part no.
Spreaders, cutters, combi tools	2.7 kg	1056401
Rescue rams (except for RZT 3-1310 XL)	2.9 kg	1056402
E-FORCE 2 tools	3.5 kg	1070296

### HAND PUMP DPH 4018-SA

- Two-stage, can be used even when not in a horizontal position (up to a maximum inclination of 20°)
- Oil volume 2.5 l
- Complete with pair of hoses 5 m, with couplings, mounted on a wooden board
- Complies to DIN 14751

Weight	14.6 kg
Part no.	1051174





# ACCESSORIES

## POWER WEDGE SPK 250

- Insertion height only 8 mm
- Creates initial opening for a pneumatic lifting bag
- Up to 61 mm lifting height
- Lifting force 25 to
- EN 13204 and NFPA 1936 tested
- Also available in E-FORCE 2-Version (page 39)



	SPK 250	SPK 250 E-FORCE 2
<b>Weight</b>	9.3 kg	12.6 kg (incl. battery)
<b>Part no.</b>	1822861	1077812

## CRASH RECOVERY SYSTEM®

### Comprehensive and up to date

- Database containing all mass-production series vehicles with airbags or alternative propulsion for cars, vans, light and heavy trucks as well as buses

### Full information

- Consistent, easy to read vehicle graphics
- Information on all rescue relevant vehicle components
- Extensive background information, photos and disabling instructions

### Saves time, increases safety

- No searching for components, know what's inside!
- Disabling instructions allow for a quick mitigation of hazards

### Mobile, flexible, easy to use

- Available Microsoft Windows, Apple iOS (iPAD) and Android
- CRS license independent of operating system, OS can be changed later

### Crash Recovery System® contains information about:

- Airbags and Airbag inflators, Seatbelt pretensioners and automatic roll bars
- Reinforcements, Batteries and fuel tanks
- Alternative propulsion components, such as high voltage batteries, gas tanks, disabling procedures
- Truck and bus components, such as chassis suspension, emergency exits, sleep cabins, lifting points

ID-No.	Content and Licence
<b>1052784</b>	Lite Edition for Windows, Apple iOS or Android (1 year license) <ul style="list-style-type: none"> <li>• Databases for Europe, USA, UK and Pacific region</li> <li>• Graphics with all locations of safety components and danger zones</li> <li>• Manual vehicle selection</li> <li>• Monthly online updates for software and database maintenance</li> </ul>
<b>8049335</b>	Standard Full Edition for Windows, Apple iOS or Android (1 year license) <ul style="list-style-type: none"> <li>• Databases for Europe, USA, UK and Pacific region</li> <li>• Interactive graphics with single click access to all component information</li> <li>• Digital photos</li> <li>• Deactivation procedures for vehicles with alternative propulsion</li> <li>• Manual vehicle selection using make, model, bodystyle and model year</li> <li>• Monthly online updates for software and database maintenance</li> </ul>
<b>8060169</b>	1 year database subscription renewal

# USEFUL MEETS RESCUER

*WEBER RESCUE s'series*





# TIPS AND TRICKS

## SPOTTING AND MARKING OF DIFFICULT AREAS

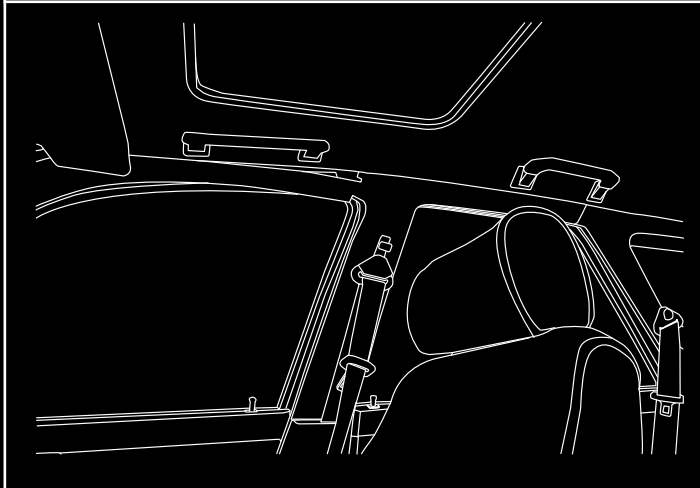
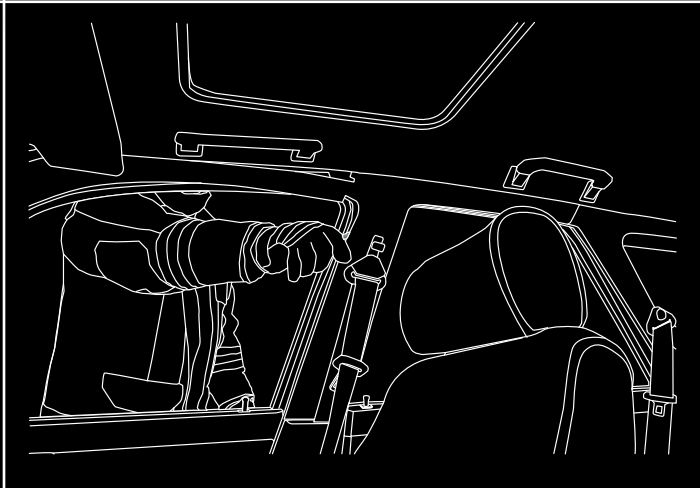
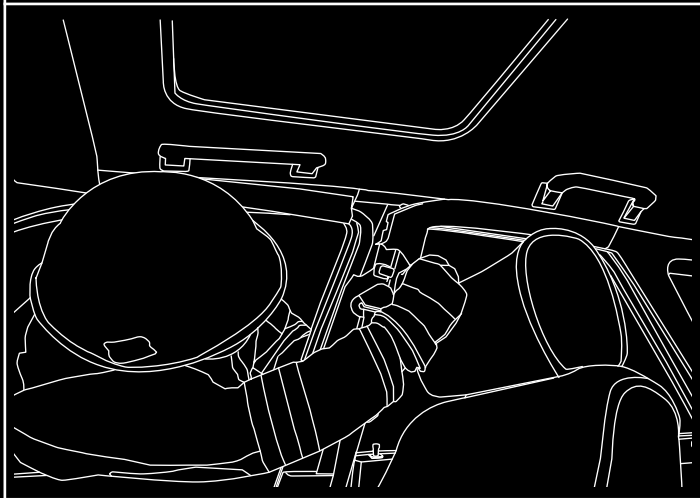
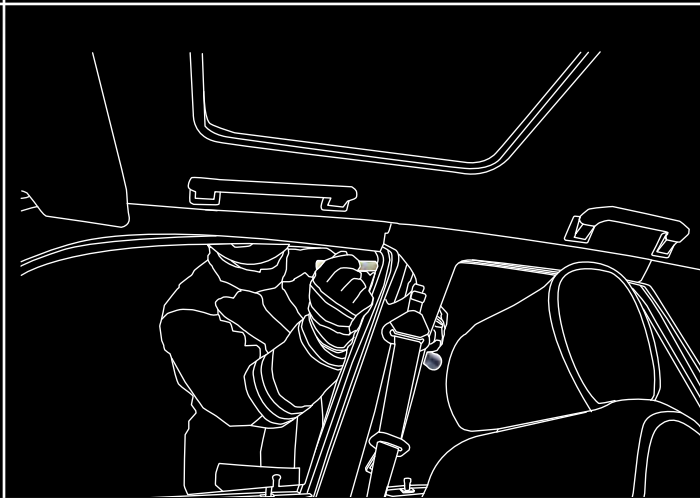
<p>Where are the seat belt adjusters, inflators and strengthened parts, e.g. pipes?</p>	<p>Lift the panel with the prying tool</p>
	
<p>Ascertain the problem</p>	<p>Mark the position with the rescue marker pen</p>
	



## S'SERIES

### S'HEBERLE (PRYING TOOL)

- To remove the interior panel
- Airbag inflators or strengthend steel parts will be located easily
- Part no. 8053863

### S'STIFTLER (RESCUE MARKER)

- Marking of cutting sides, spreading points and the base frame spots
- Top-dressing, permanent colour paste
- Photostable and smear-resistant

	Part no.
s'Stiftle yellow	8056501
s'Stiftle red	8056510

### S'GURTSCHNEIDERLE (SEAT BELT CUTTER)

- For quick, easy and safe cutting of the seat belt
- Design of a cutter
- Part no. 1058692

### S'BÄLLE (BALL)

- Two yellow balls, 70 mm diameter
- To fix the door handle and keep the door lock open
- In carrying bag with rope to be fastened at the waistbelt
- Part no. 1058691

### S'BÜCHLE (BOOKLET)

- Pocket sized tips and tricks
- Everything worth to know on 92 pages
- Format DIN A6
- Part no. 1067550

### S'MASSBÄNDLE (TAPE MEASURE)

- Quick and precise identification of the suitable rescue ram
- Part no. 1055707





## S'SERIE

### S'TÄSCHLE (TOOL BAG)

- Tool bag made of CORDURA®
- Clearly arranged and individual division
- No loss of mobility because of holster design
- Delivery without content

	Part no.
s'Täschle white	1051517
s'Täschle red	1051518
s'Täschle yellow	1051519



### S'SCHREIBPÄCKLE (TACTICAL WRITING SET)

- Adheres to any surfaces thanks to its electrostatic charge
- Flexible and easy to handle
- Part no. 1065542

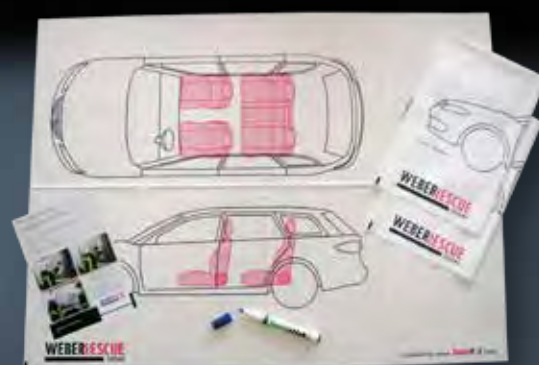

### THL-PROTECTIVE GLOVES

- Kevlar/glass fibre lining and Kevlar gauntlet
- Protection class acc. to EN 388: 3, 5, 4, 3
- Pre-curved fingers, seamless finger tips
- Palm abrasion resistant and antiskid

Size	Part no.
7	1067354
8	1067355
9	8055742
10	8055750
11	8055769
12	1067357



### S'HANDSCHUHALTERLE (GLOVE HOLDER)

- With velcro fastener and carabiner to hook into the waistbelt
- Part no. 8071250

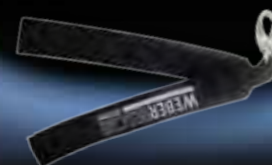

### S'TÜCHLE (BANDANA)

- Ideal to wear under the helmet
- To absorb sweat, washable
- Multi-use, universal size
- Part no. 8071268



## DVD-SERIES

### TECHNICAL RESCUE

No.	Title	Part no.
1	Standard intervention rules - car	8048126
2	New car technologies	8048134
3	Medical rescue	8048142
4	Different rescue techniques	8048150
5	Natural gas and hybrid vehicles	8048169
6	Transporter and bus accidents	8048177
7	Truck rescue	8048185

### SCBA TRAINING

No.	Title	Part no.
1	Standard procedures	8065039
2	Flashover and nozzle techniques	8065047
3	Tactical ventilation	8065055
4	SAR systems	8065063
5	Thermal imaging camera	8065071
6	Emergency procedures	8065080

## TRAINING

### RESCUE DAYS

- The worlds largest training event on technical rescue
- Takes place once a year in Germany (each year different locations)
- Appr. 800 participants form more than 20 different countries
- 80 international trainers (fire fighters and rescue services)
- Theory and practice
- Location 2016 Bad Kreuznach (Rheinland-Pfalz)

Training Programme	Part no.
<b>RESCUE DAYS (2 days)</b>	8051550
<b>RESCUE DAY PLUS (1 day)</b>	3250060
<b>RESCUE DAY BUS (1 day)</b>	8055084
<b>RESCUE DAY COMPACT (1 day)</b>	8055092
<b>RESCUE DAY SYMPOSIUM (1 day)</b>	8069905

# rescue DAYS







Edition 2016/2017C Subject to modification

## WEBER-HYDRAULIK GMBH

Heilbronner Straße 30  
74363 Güglingen/Deutschland  
Telefon +49 (0) 7135/71-10270  
Telefax +49 (0) 7135/71-10396  
info@weber-rescue.com

Industriegebiet 3 + 4  
4460 Losenstein/Österreich  
Telefon +43 (0) 7255/6237-120  
Telefax +43 (0) 7255/6237-12461  
info@weber-rescue.com

# WEBER RESCUE

---

SYSTEMS

[www.weber-rescue.com](http://www.weber-rescue.com)